

UPGRADE OF THE LNS FACILITIES

The CS upgrade with the implementation of the extraction by stripping opens up new appealing possibilities using both stable or unstable beams produced by projectile fragmentation

- **Design and realization of a new in flight fragment separator** to allow for an improvement in the transport efficiency of exotic beams to experimental areas
- **Improvement/upgrade of the existent LNS experimental set-up (MAGNEX, CHIMERA)**
- **Development of new devices: helical orbit spectrometer**

LNS map

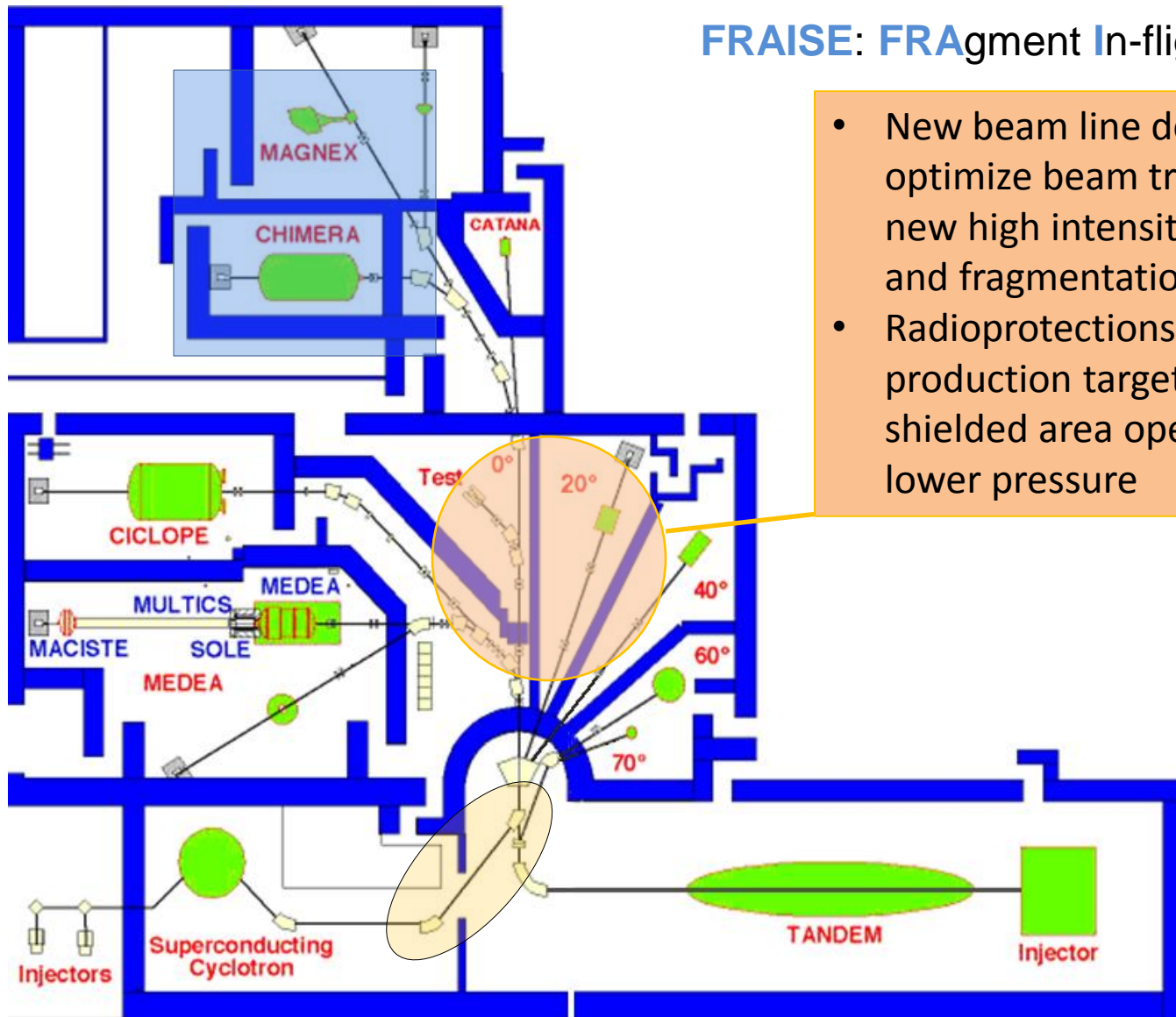

FRAISE: FRAGMENT In-flight SEparator

- New beam line designed to optimize beam transport of new high intensity CS beams and fragmentation products
- Radioprotections issues: production target in a shielded area operating at lower pressure

FRAISE: the new LNS fragment separator

Beam line to Magnex and CHIMERA

The new fragment separator consists of:

- 2 - 70° dipoles $R=2000$ mm
 $H=\pm 200$ mm
 - 2 - 40° dipole $V=\pm 35$ mm
 - 2 triplets
 - 2 doublets
- Bore \varnothing 140 mm

Performances relative to FRIBS:

- Gain of a factor 5 in momentum acceptance
- Gain of a factor 2 in resolving power

Secondary beam production target

Output Slit

Degrader

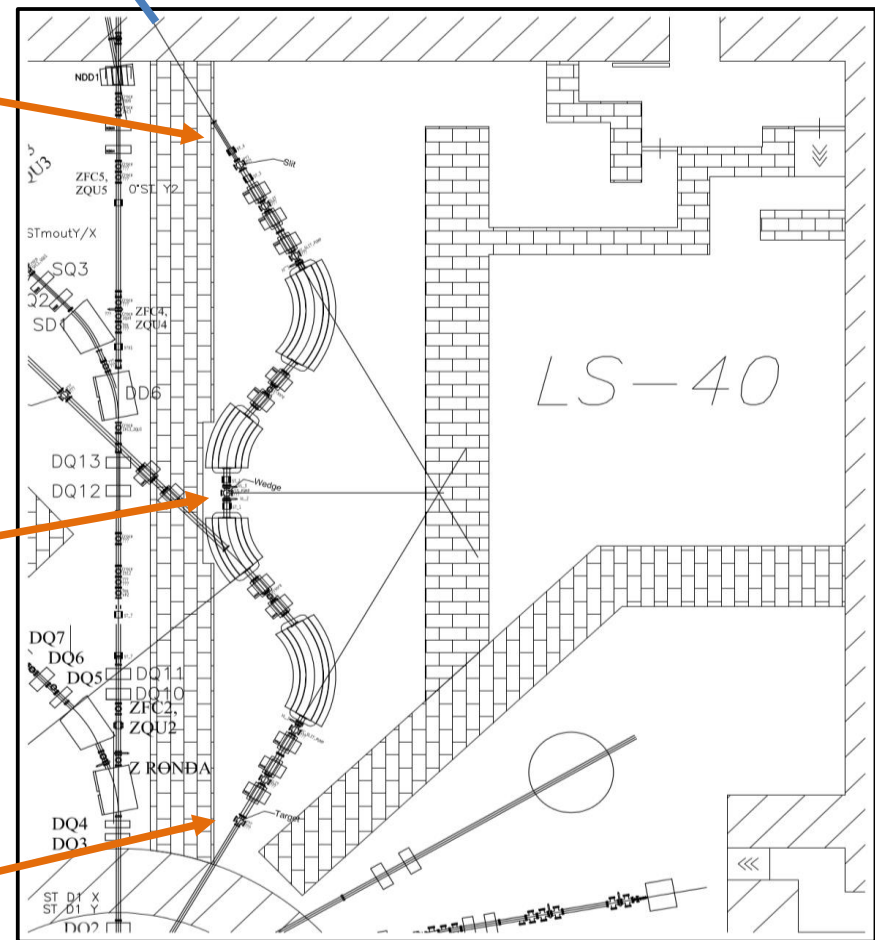

LNS experimental set up

MAGNEX spectrometer



- NUMEN project
- GMR

CHIMERA



- ISOSPIN physics
- Cluster structure in nuclei
- Femtoscopy (see E. De Filippo talk)

FARCOS

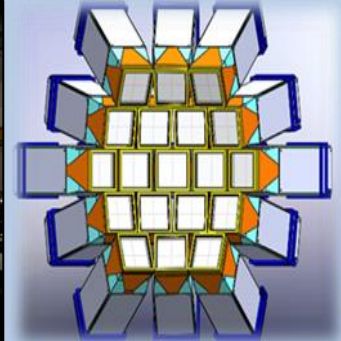

PANDORA (Plasma trap)

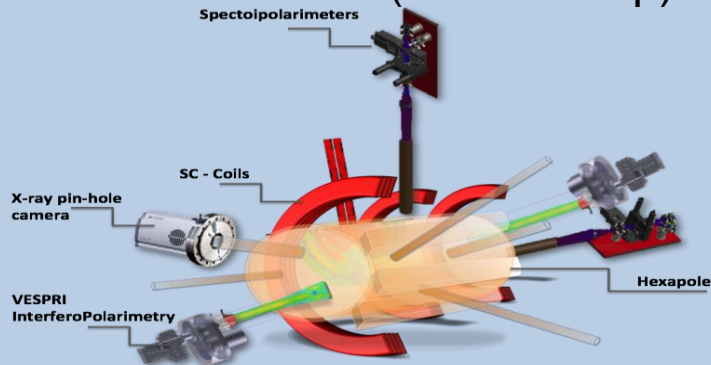

Online production of radionuclides, trapping in magnetoplasma and study of decay times vs ionization states

Helical orbit spectrometer using SOLE

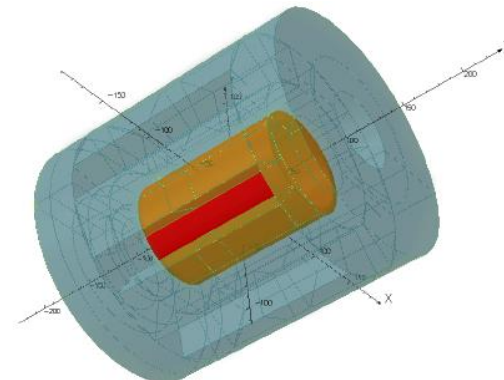

Nuclear structure of exotic nuclei

Helical Orbit Spectrometer

MAIN IDEA:

- Large-bore solenoid with a magnetic field (2-5 Tesla), uniform in the volume
- Beam intercepts a target inside the solenoid along its magnetic axis
- Light charged particles ejected from the target follow a helical orbit and are focused on the solenoid main axis.
- Detection: position sensitive Si array placed around the beam axis allowing for beam transport and recoil measurement

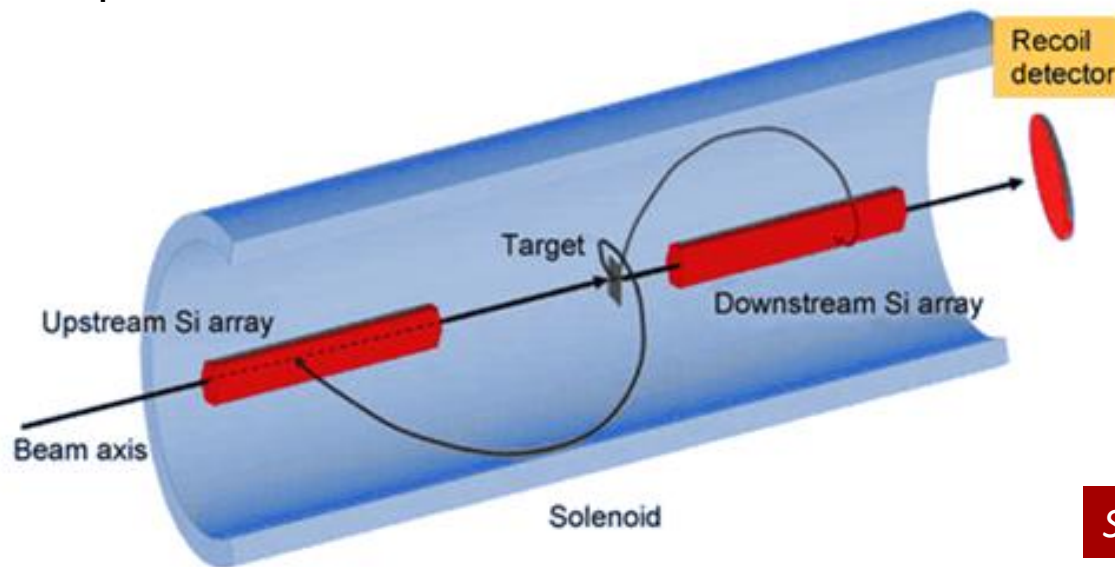

Scheme HELIOS

Ideal tool to study direct reactions in inverse kinematics

(HELIOS@Argonne, ISS@ISOLDE)

Solenoid Kinematics

Particles trajectories can be defined by the orientation of the \vec{V}_{lab} relative to solenoid axis

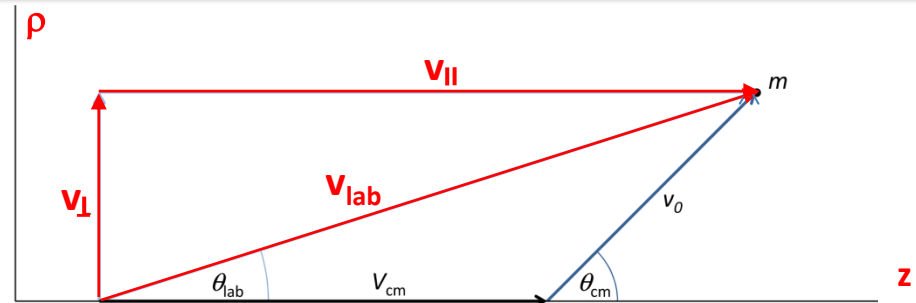

v_{\perp} defines the radius of cyclotron motion for a particle of mass A and charge q in B field

$$r = v_{\perp} \frac{m}{qB}$$

$$T_{cycl} = \frac{2\pi r}{v} = \frac{2\pi m}{Bq} = \frac{65.6 m}{Bq} \text{ (ns)}$$

The position at which particles return to solenoid axis varies according to:

$$z = v_{par} T_{cyc}$$

What we need to measure:

- Particles **ToF**
- Impact point **z**
- E_{lab}

Derived quantities:

- m/q
- E_{cm}
- Θ_{cm}

$$\Theta_{cm} = \arccos(qeBz - 2\pi m V_{cm} / (2\pi \sqrt{2m E_{lab} + m^2 V_{cm}^2} - m V_{cm} qeBz / \pi))$$

$$E_{cm} = E_{lab} + 1/2 m V_{cm}^2 - V_{cm} eqBz / 2\pi$$

Helical Orbit Spectrometer: from (E_{lab}, Θ_{lab}) to (E_{lab}, z)

Advantages:

- Particle identification through $ToF = T_{cycl}$
- Enhanced Q-value resolution
- No kinematical compression effects ($\Delta E_{lab} = \Delta E_{cm}$)

Ion	$T_{cycl} = ToF$ (ns)	
	B = 2 Tesla	B = 3 Tesla
p	32.8	21.9
d, Alfa ²⁺	65.6	43.7
t	98.4	65.6
³ He	49.1	32.7

What it can be studied depends on :

- Two-body Kinematics
- Solenoid Size
- Solenoid B intensity
- Array

The quality of the results:

- B field degree of homogeneity
- type/shape of the detection array
- beam energy resolution
- beam spot size
- target thickness

$D(^{134}\text{Sn}, p)^{135}\text{Sn}$ @ 6A MeV

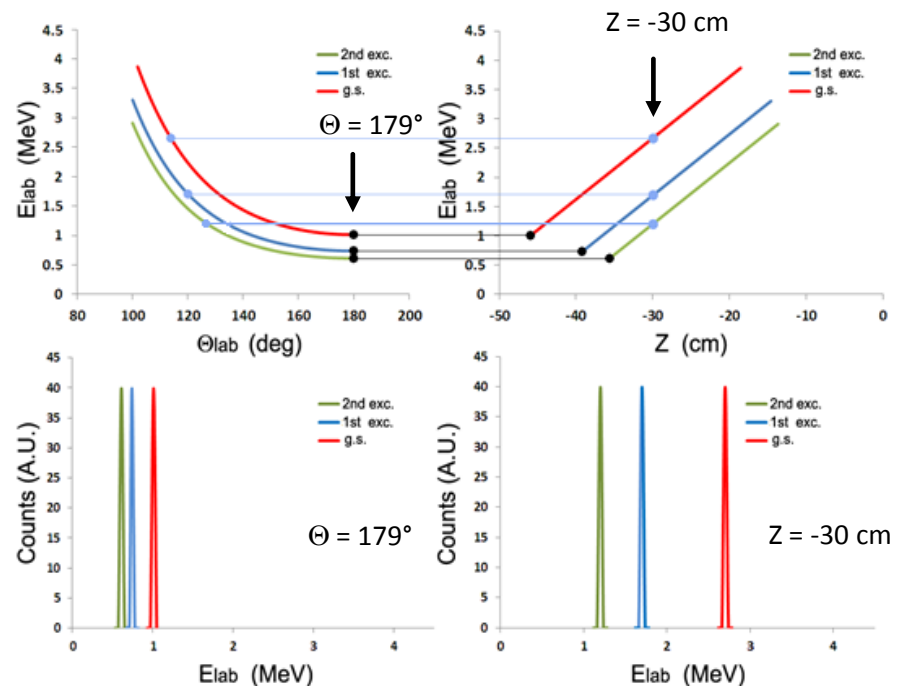

Detection system: Si array geometry

Particle trajectories in the solenoid

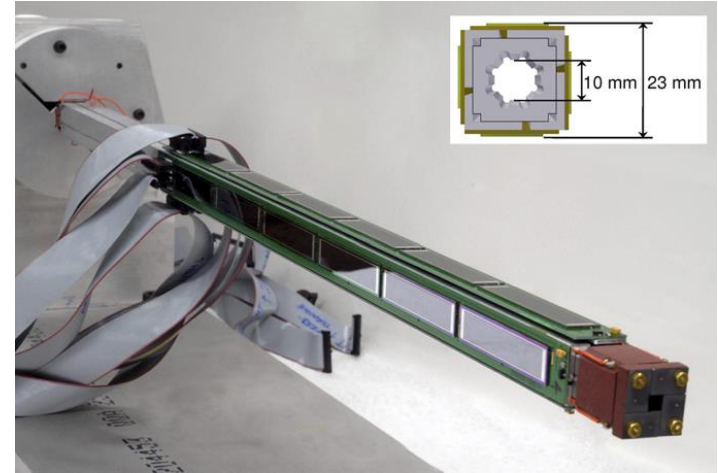
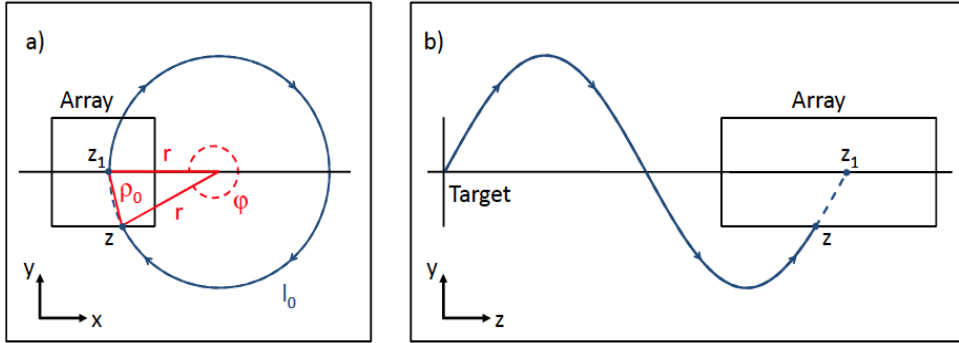

Z impact point – protons

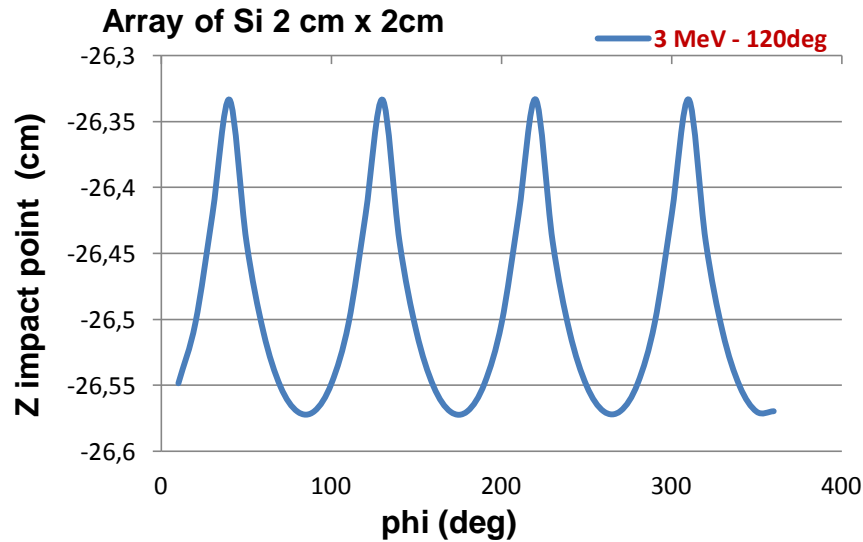

Beam size effects

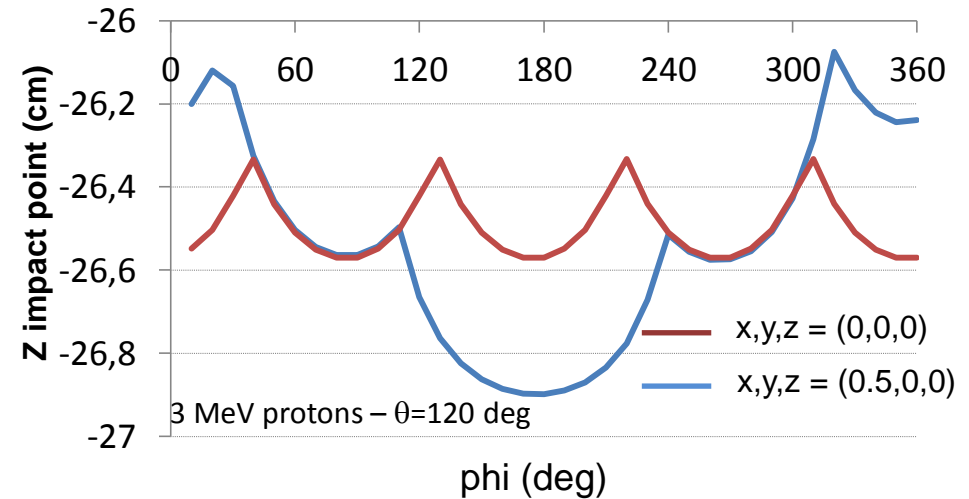

The LNS solenoid SOLE

MEDEA

SOLE

MACISTE

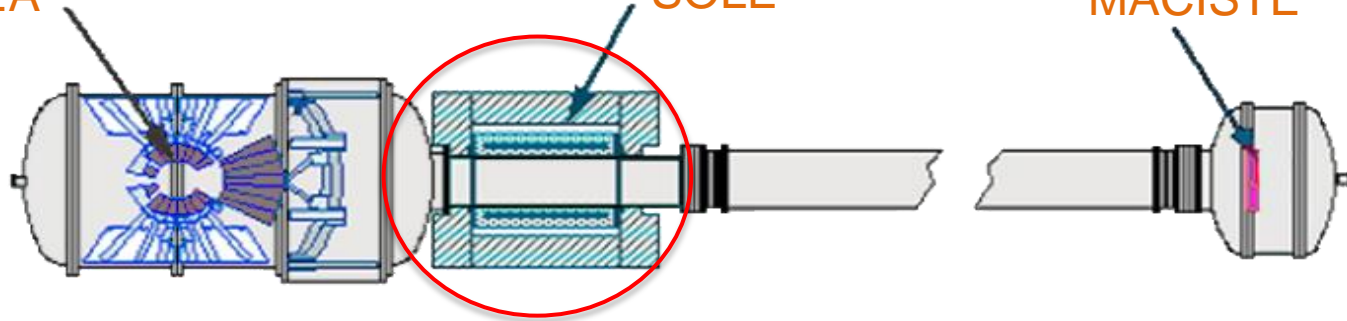

SOLE:

Superconductive solenoid with $B_{\max} = 5$ Tesla

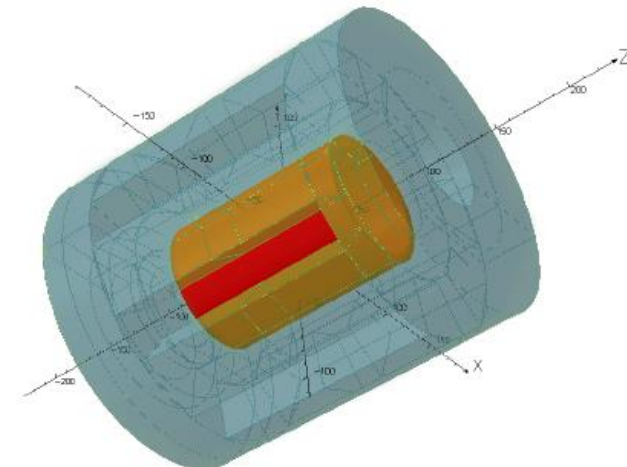
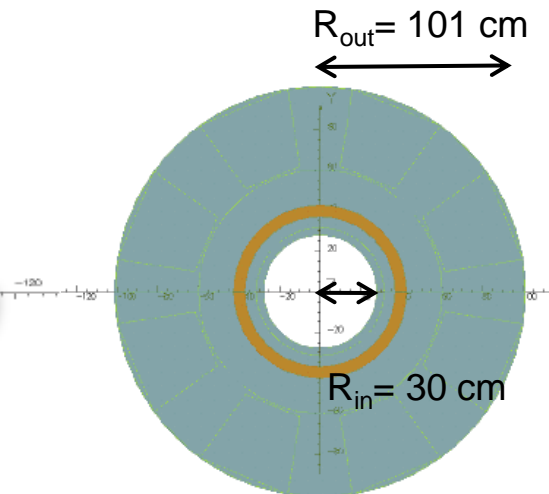
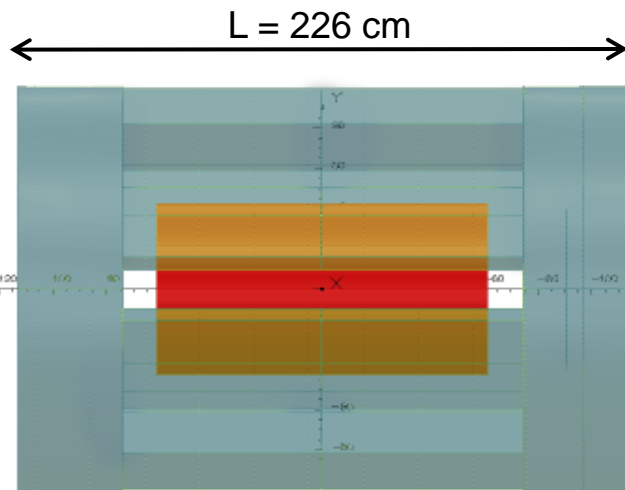

SOLE model using OPERA

Study of an Helical Orbit Spectrometer @ LNS

SOLE axial magnetic field in OPERA

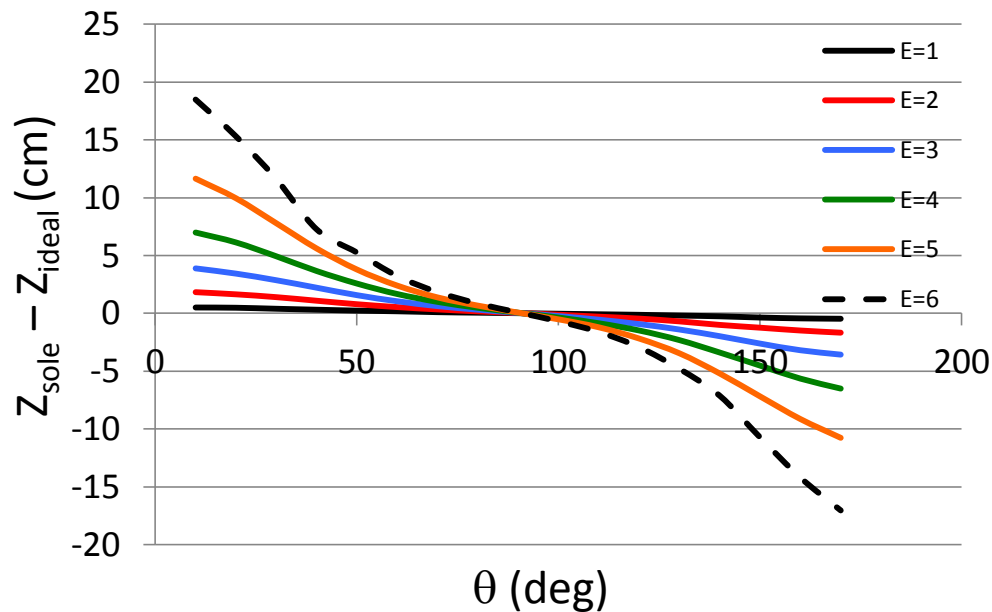
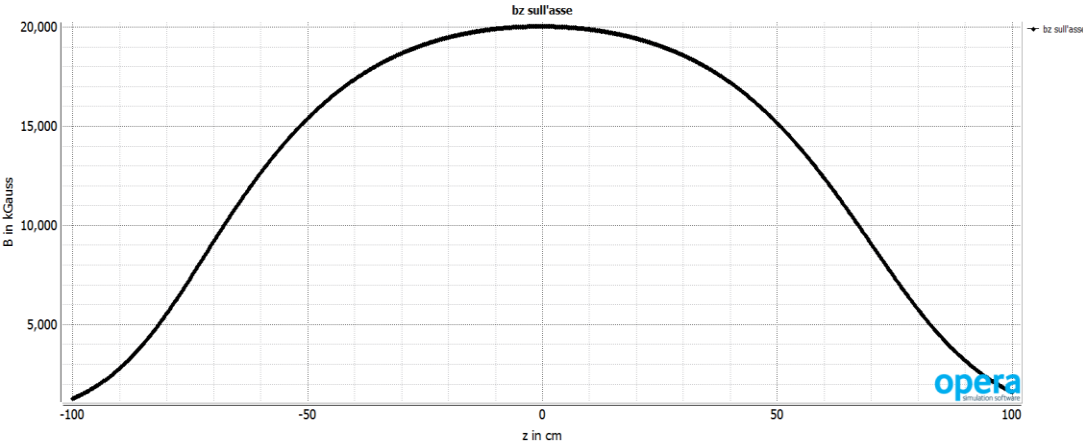

Z impact point of protons vs theta

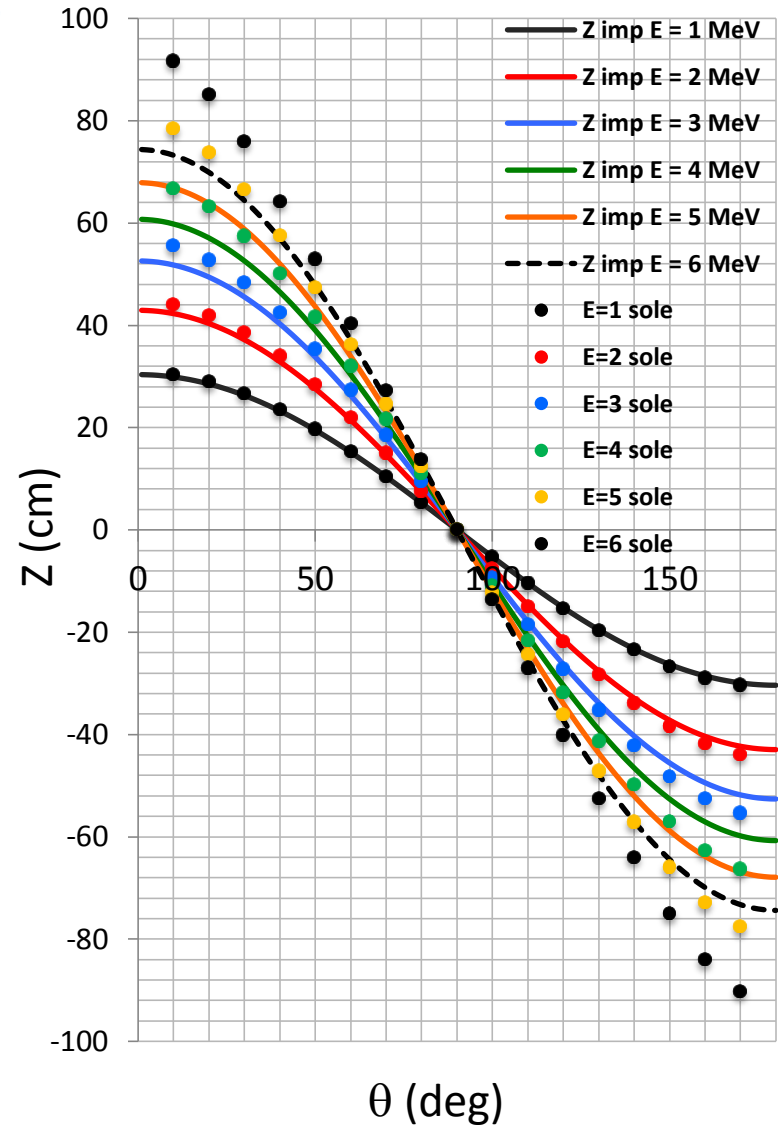

Study of an Helical Orbit Spectrometer @ LNS

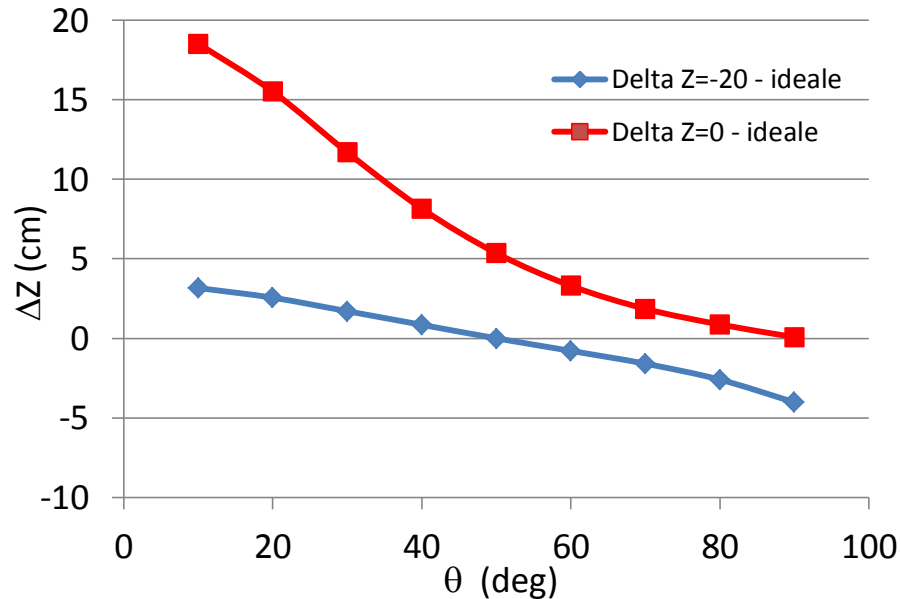
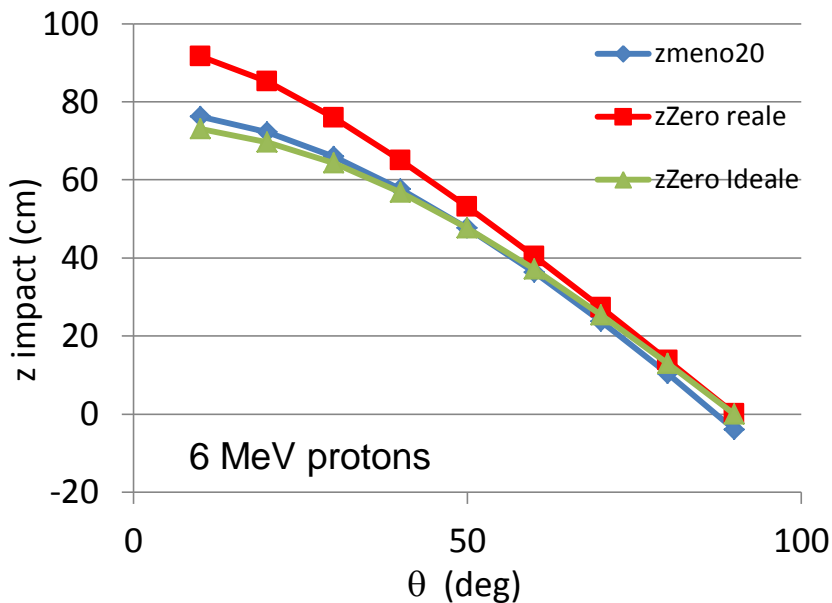
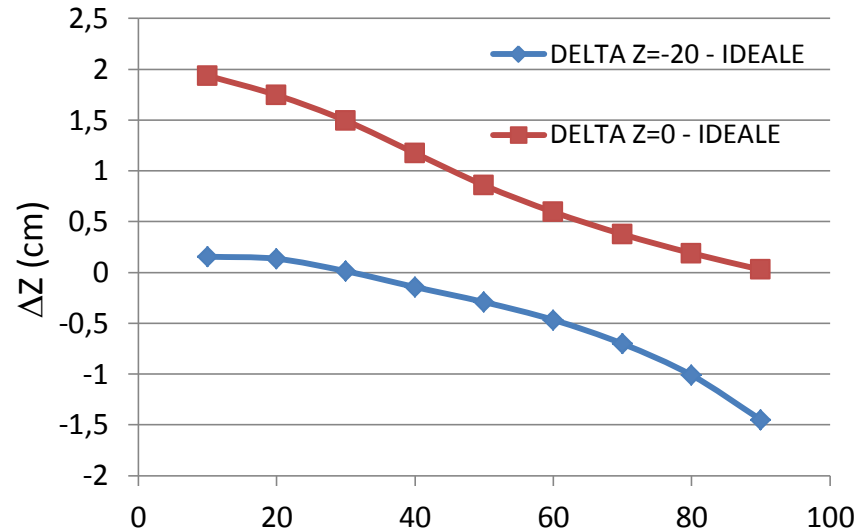
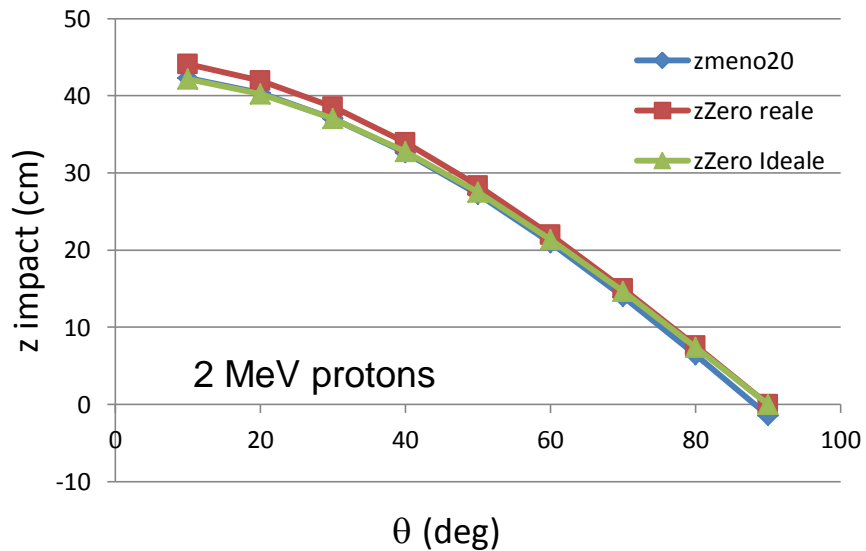

Beam size effects

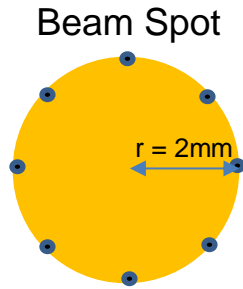

Protons:
 $E = 4 \text{ MeV}$, $\theta = 70^\circ$
 $E = 4 \text{ MeV}$, $\theta = 70.5^\circ$

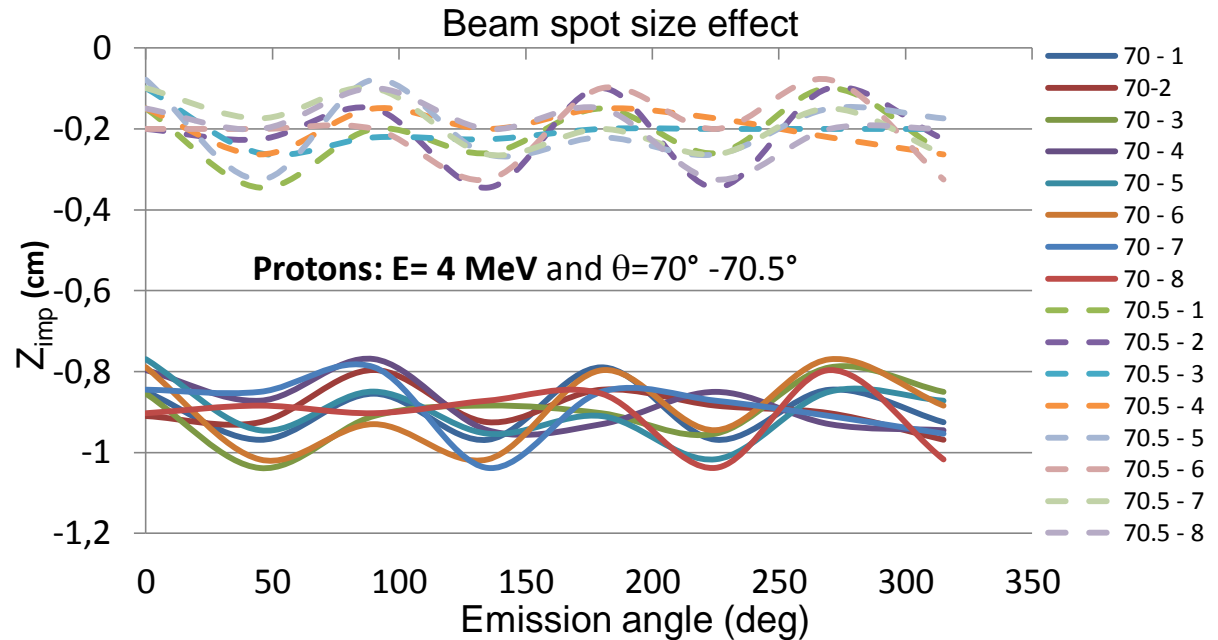

Future activities:

- Detailed map of the magnetic field
- Charged particles transport simulations with measured field
- Test of the performances with a tandem beam

Study of an Helical Orbit Spectrometer @ LNS

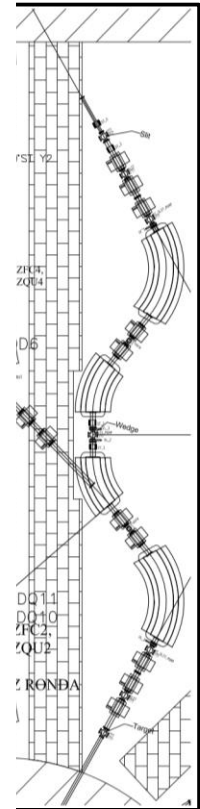
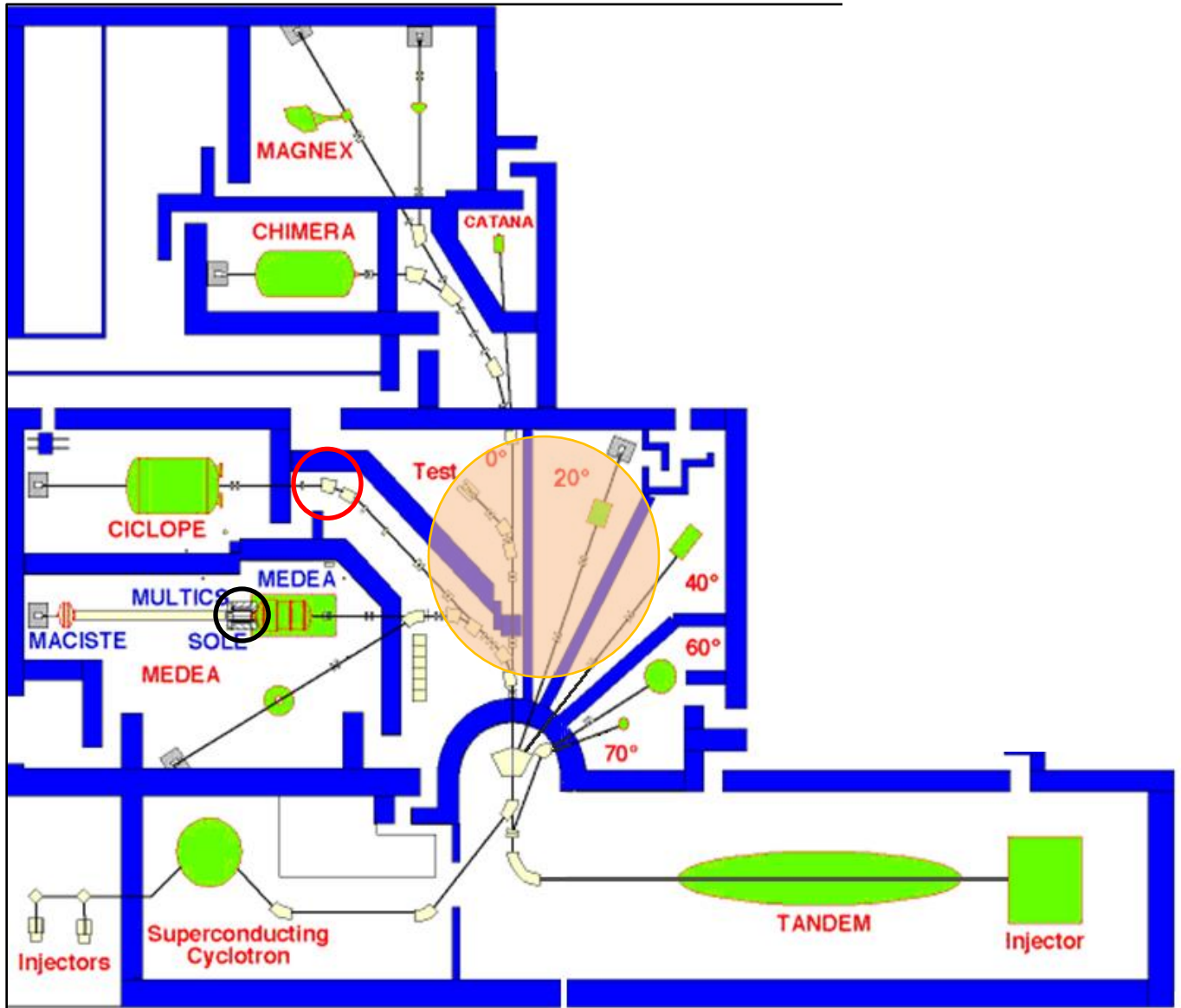

A.Russo

Physics case: existence of proton halo in ^8B through (p,p') scattering

Studies of ^8B structure through momentum distribution of ^7Be fragments following ^8B breakup are not conclusive concerning the existence of halo (MSU and GSI exp.)

Quasi elastic scattering of ^8B on ^{12}C at GANIL doesn't support the existence of proton halo (Pecina et al. PRC52(1995) 91)

Elastic and inelastic scattering through (p,p') at MSU are coherent with the existence of a proton halo but some limitation in the data exists

^8B	E (MeV)
3 ⁺	2.32
1 ⁺	.77
2 ⁺	<i>S_p = .137</i>
	g.s.

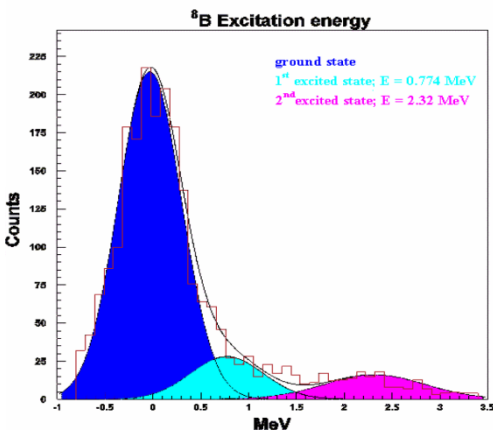
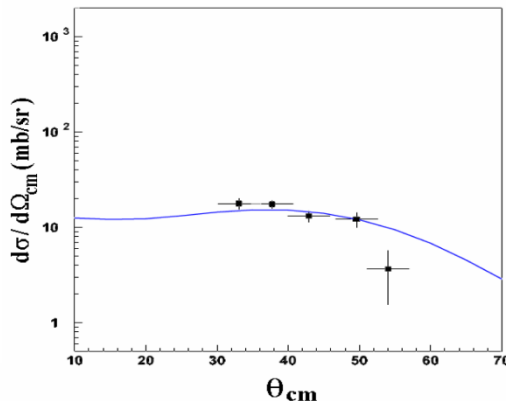
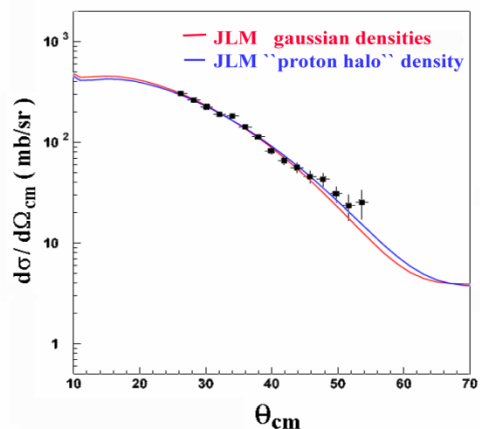

- Limited energy resolution
- Statistics at large angles

Measured $B(E2) = 70 e^2\text{fm}^4$
 Theoretical predictions:
 $B(E2) = 9 e^2\text{fm}^4$
 Study of inelastic to 3⁺ state

Helios-like spectrometer is expected to have a much better resolution

^8B Yield with FRAISE
 Yield $^8\text{B} = 1.86 \cdot 10^5$ pps (purity 56%)
 Main contaminant ^7Be

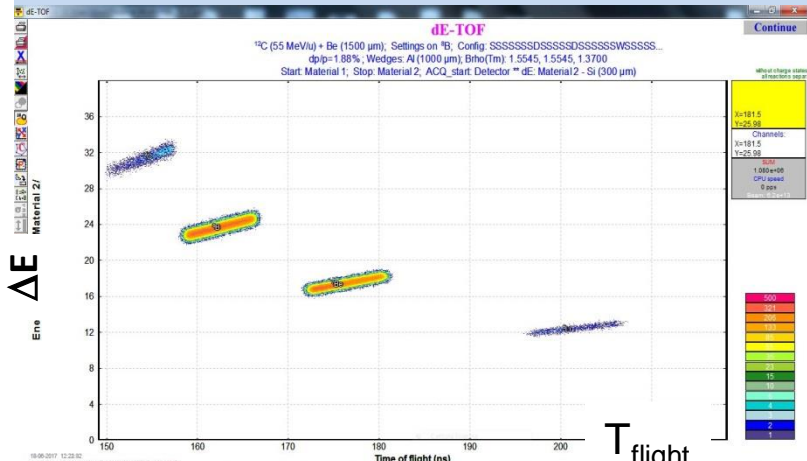

Summary

- Upgrade of FRIBS and detectors
- Helical orbit Spectrometer
- Main advantages of (E_{lab}, z) detection
- Detection Array main features
- Study of an Helical Orbit Spectrometer @ LNS
- Applications to exotic nuclei

Study of an Helical Orbit Spectrometer @ LNS

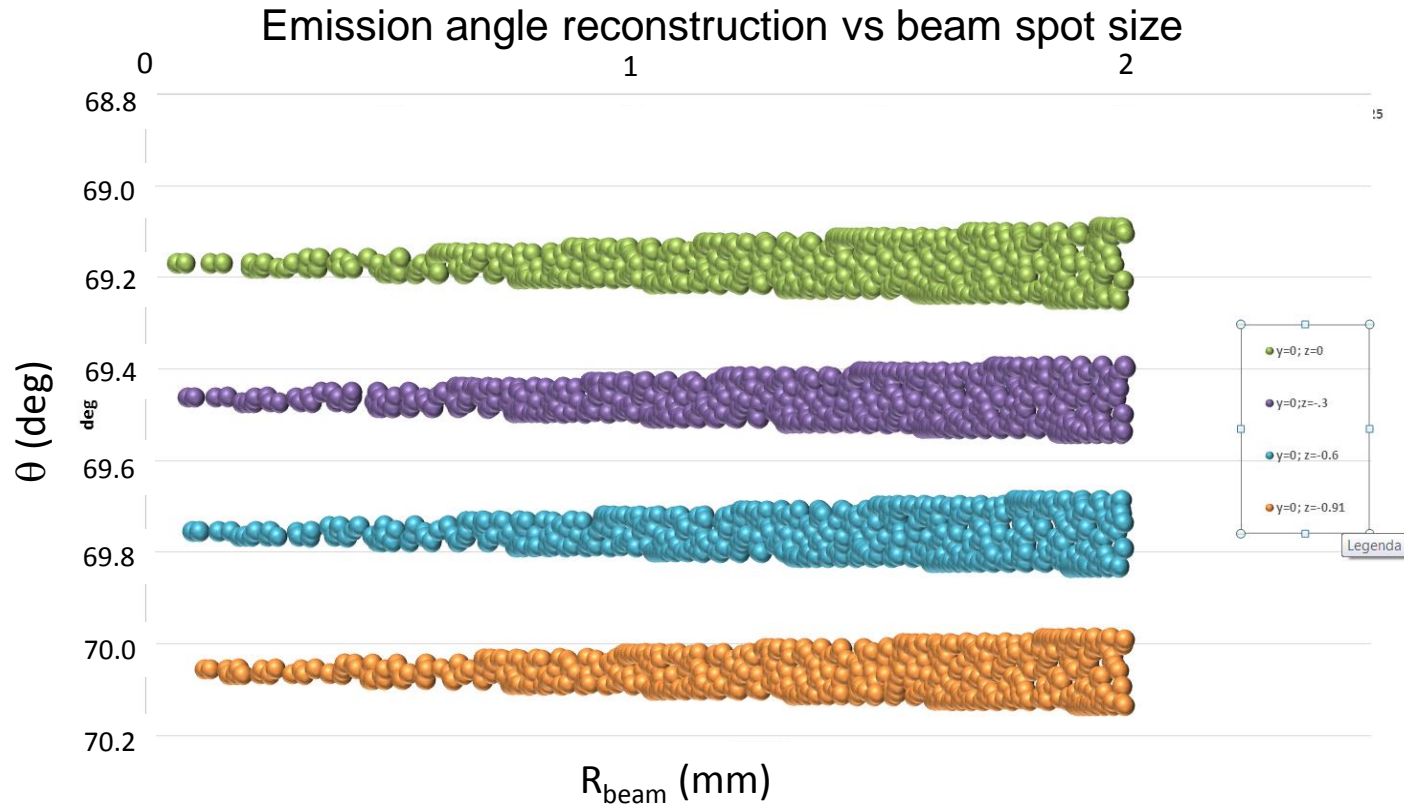

Activities:

- Detailed map of the magnetic field
- Charged particles transport simulations with measured field
- Test of the performances with a tandem beam

Solenoid magnetic field homogeneity

Helios uses a solenoid built for NRM with a B field homogeneity of the order 10^{-4}

Region of homogeneity Length ≈ 2 Radius

Simulations: Solenoid with a degree of homogeneity of the order of 10^{-3} and 10^{-4}

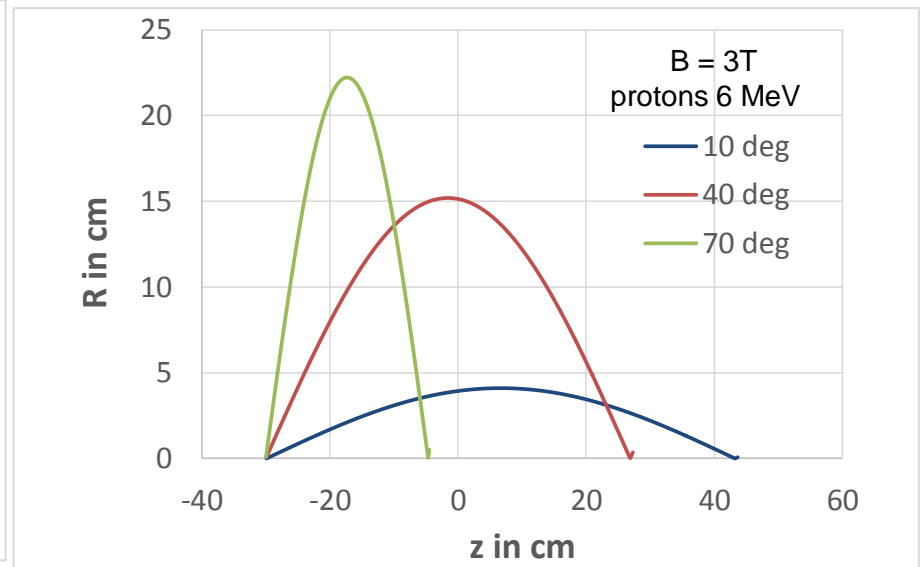
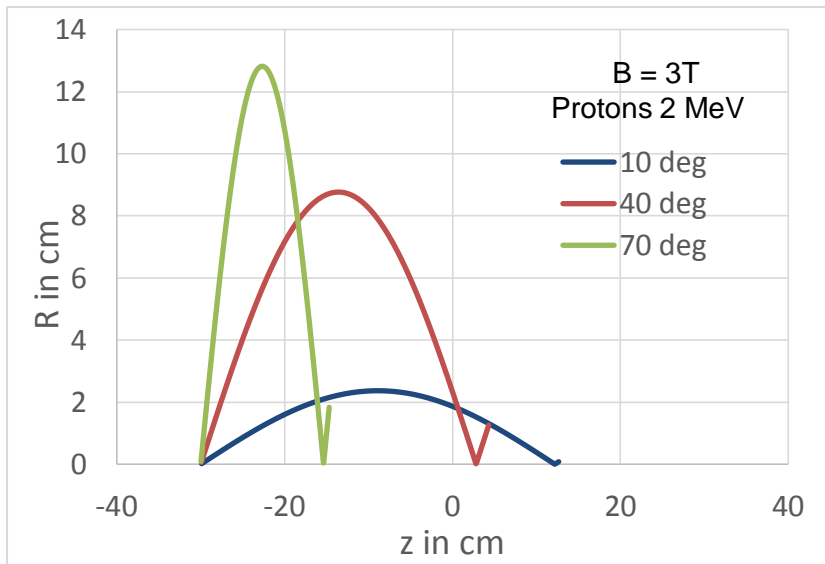

$$\Delta x (\text{Sole_ideal} - \text{Sole}_{10^{-3}}) = f(E, \Theta_{\text{lab}})$$

$$\text{Es: proton } 6\text{ MeV, } \Theta_{\text{lab}} = 10^\circ \quad \Delta x = 1.2\text{ mm}$$

$$\Delta x (\text{Sole_ideal} - \text{Sole}_{10^{-4}}) = f(E, \Theta_{\text{lab}})$$

$$\text{Es: proton } 6\text{ MeV, } \Theta_{\text{lab}} = 10^\circ \quad \Delta x = 0.5\text{ mm}$$

Solenoid

Main parameter governing spectrometer acceptance :

- B intensity
- Radius(R)
- Length (L)
- The extent of the magnetic field and array geometry imposes limits on the acceptance region

R_{\max} from solenoid axis (cm)

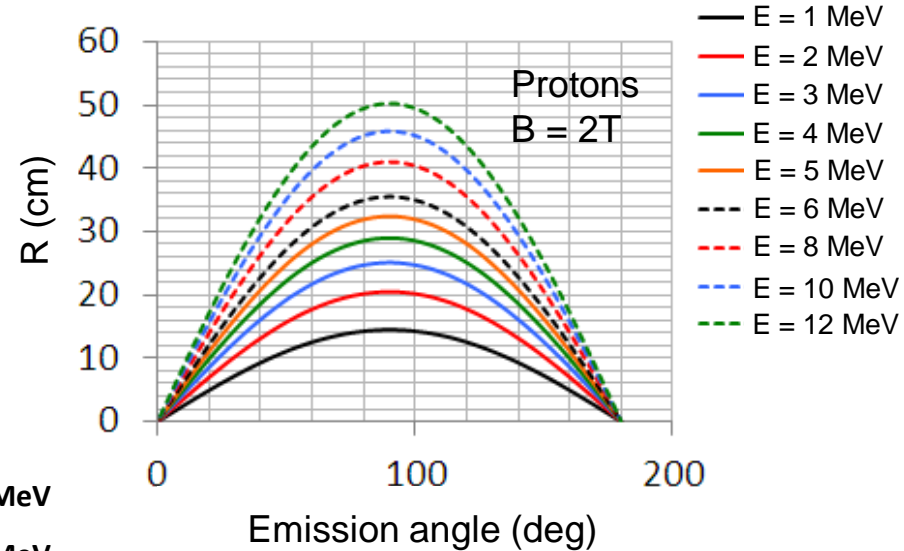

Impact point along the solenoid axis

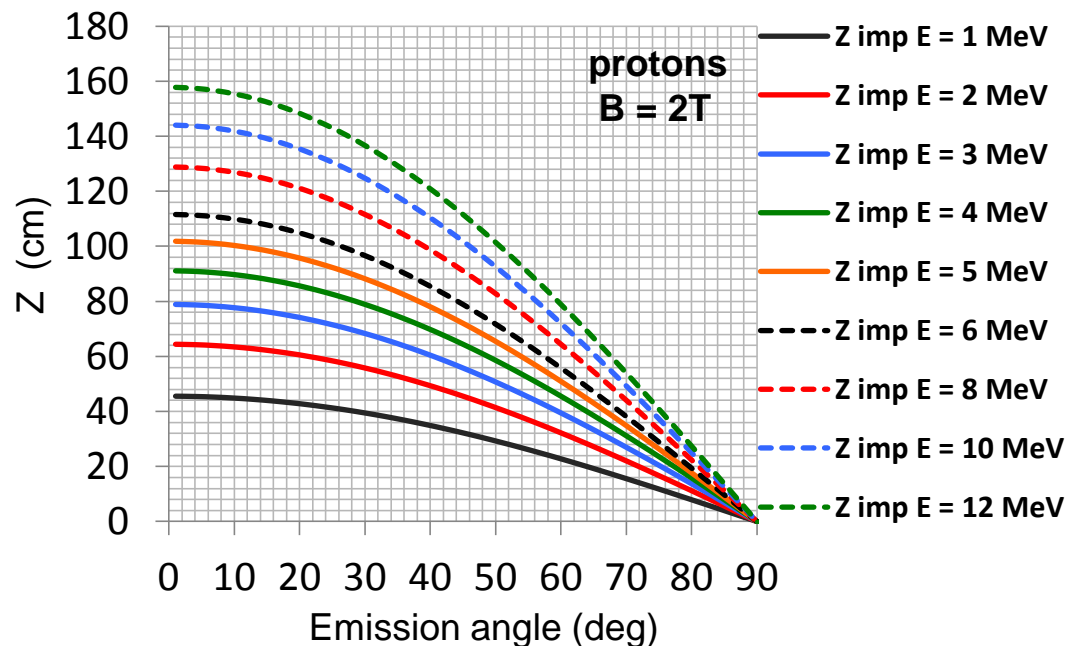

Requirements:

- Variable field to optimize the focalization of particles (p,d,t,a) on the detector array
- Homogenous field size:
 - Radius 40 cm
 - Length ~100-120 cm

Helical Orbit Spectrometer: applications

Nuclear structure studies with low intensity beams → direct reactions

- Elastic Scattering (density distribution of p,n)
- Inelastic Scattering (excited states, collectivity, $B(E2)$, $B(E3)$)
- One nucleon transfer (single particle states, astrophysical processes)
- Two nucleon transfer (pair correlations)

Two-body reactions in inverse kinematics: easier to detect the light reaction partner

Problems:

- Low energy particles - identification
- Strong angular dependence
- Kinematical compression at large lab. angle
- Low intensity beam (detection efficiency)

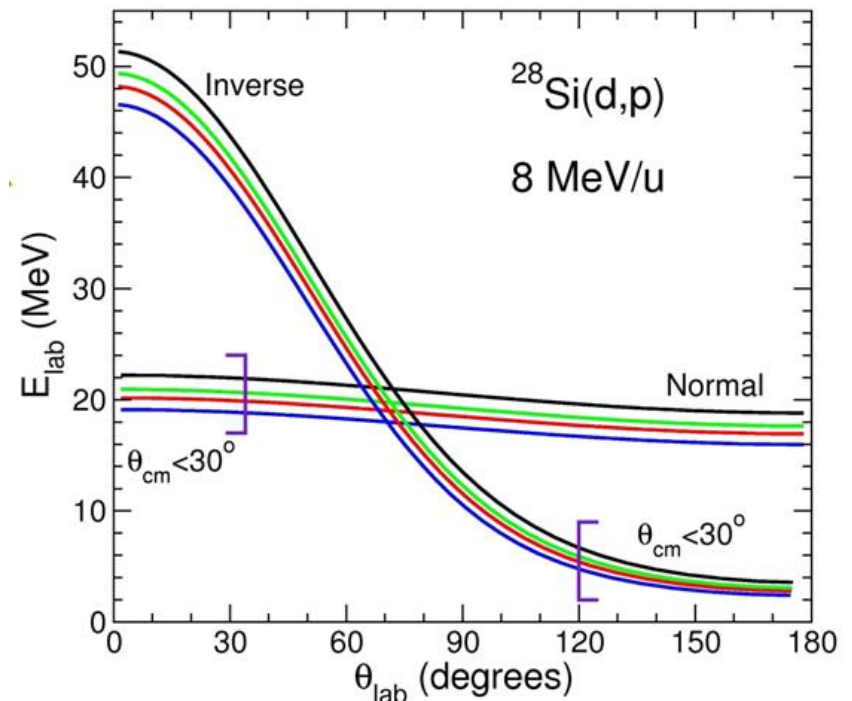

Detection system: Si array

Array geometry depends on the kinematics

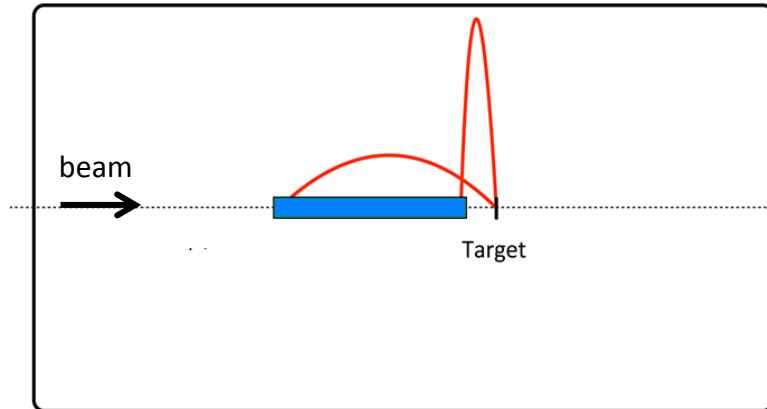

Es: (d,p) (t,p) (^3He ,d) (^3He , α)

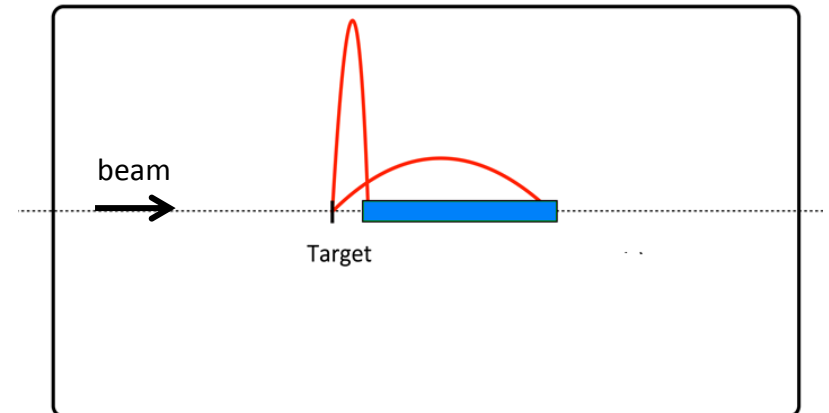

Es: (p,p') (p,d) (^3He ,t)

Setup Si di HELIOS

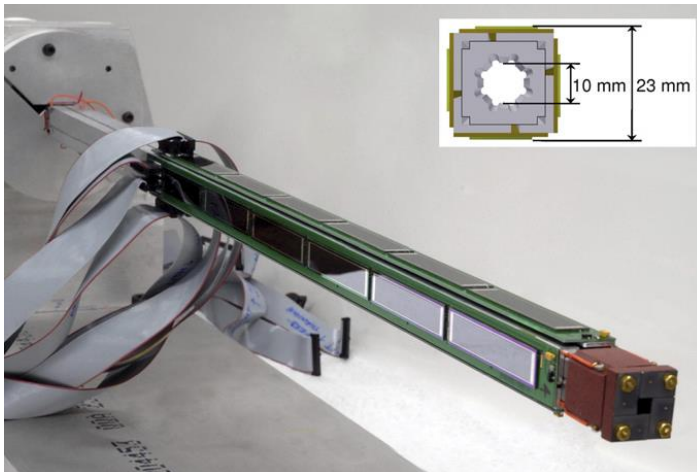

Detectors:

- Position sensitive Si, thickness: 1000-1500 μm

Geometry:

- Array with a regular polygonal cross-section
- Array length: 500 – 800 mm
- Two opposite requirements (beam transport – particle detection)

Beams with the new fragment separator

BEAM	primary beam / energy (AMeV)	thickness be target (μm)	thick wedge (μm)	optimistic YIELD FRIBS 100 W (kHz)	purity %	primary beam intensity (kW)	YIELD new separator (kHz)	purity %	beam energy after tagging (AMeV)
14Be	18O/55	1500	0	0,06	1	2	2,6	2	46
14Be	18O/55	1500	1000	0,04	95	2	2,2	70	43
13N	16O/40	700	600	14	58	2	1230	54	4
14O	16O/40	700	600	10	41	2	807	36	4
18Ne	20Ne/60	1000	0	330	20	2	16700	16	43
18Ne	20Ne/60	1000	1000	34	58	2	3120	47	24
17F	20Ne/60	1000	1000	24	41	2	3300	49	23
34Si	36S/40	500	500	20	90	2	980	81	11
38S	40Ar/40	500	300	63	90	2	1840	66	17
34Ar	36Ar/50	250	0	141	10	2	2800	4	41
34Ar	36Ar/50	250	500	22	44	2	426	12	4
68Ni	70Zn/40	250	200	53	80	1	490	50	18

Rate will increase (up to) 2 order of magnitudes!