

Theory status of $e^-e^+ \rightarrow 4f$ production

Christian Schwinn

— Univ. Freiburg —

5 February, 2015

Four-fermion production

- Explored at LEP 2 with $\mathcal{L} = 3 \text{ fb}^{-1}$ from $\sqrt{s} = 161.3\text{-}206.6 \text{ GeV}$
- Precision tests of standard model:
 - cross-section measurements
 - m_W, Γ_W
 - triple-vector boson couplings
- Important for precision physics program at any future e^-e^+ collider
- Pushes methods of perturbative QFT for complicated processes:
 - gauge invariant definition of signals
 - consistent treatment of finite-width effects
 - different scales
 - many Feynman diagrams

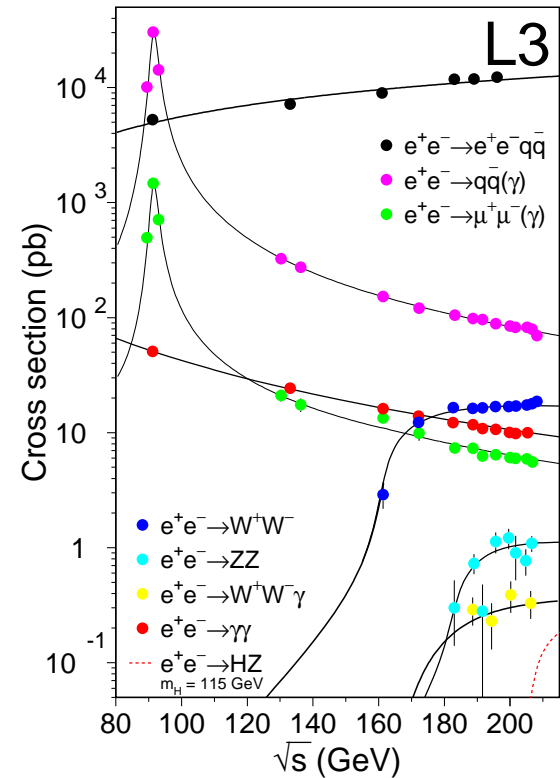

Prospects at future e^-e^+ colliders

- FCCee (90-400 GeV) with $\mathcal{L} \sim \text{ab}^1/y$
- ILC (90-500 GeV),
- CLIC (≤ 3 TeV)

Goals

- $\Delta M_W \sim 3\text{-}4 \text{ MeV}$ (ILC), $\lesssim 1 \text{ MeV}$ (FCCee)
- $\Delta \sin \theta_{\text{eff}}^l \sim 1.3 \times 10^{-5}$ (ILC) , 0.3×10^{-5} (FCCee)
- Triple gauge couplings:
reduction of errors by one or two magnitudes compared to LEP (ILC)

Prospects at future e^-e^+ colliders

- FCCee (90-400 GeV) with $\mathcal{L} \sim \text{ab}^1/y$
- ILC (90-500 GeV),
- CLIC (≤ 3 TeV)

This talk

- Overview of LEP2 4-fermion signatures and theory status
- Theoretical issues
- Theory developments since LEP2
- Outlook

Resources

- LEP2 Theory: Grünewald et al. [hep-ph/0005309]
- LEP2 Experiment: Schael et al. [arXiv:1302.3415]
- FCCee WG2 <http://tlep.web.cern.ch/content/wg2-exp>

Classification of signatures at LEP

- WW : Cross section, M_W , Γ_W , branching ratios, anomalous couplings
- ZZ : Cross section
- $Z\gamma$: Cross section, anomalous couplings
- $W_{e\nu}$: Cross section, anomalous couplings
- Zee : Cross section

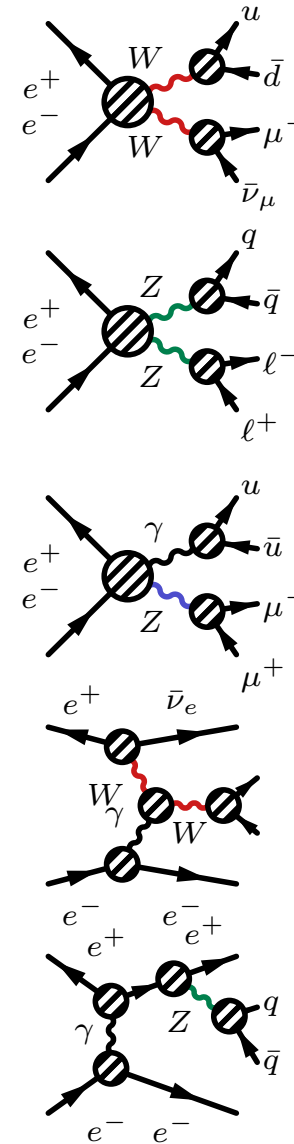

4-fermion production at tree level, e.g. $e^-e^+ \rightarrow \mu^- \bar{\nu}_\mu u \bar{d}$

Double resonant ('signal') diagrams (CC3):

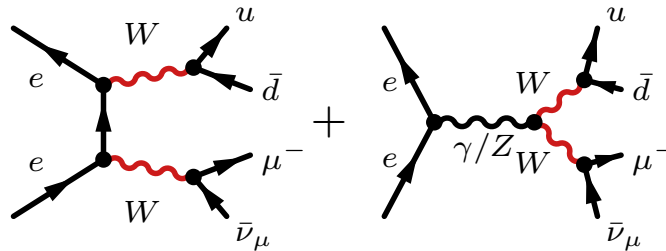

But 10 diagrams in total:

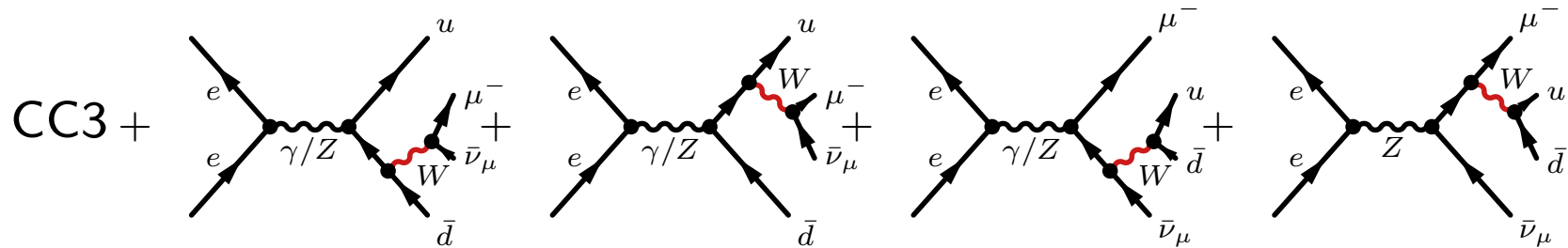

Only sum gauge invariant

Need consistent scheme for finite width effects:

(Beenakker et al. 96)

\sqrt{s}	200 GeV	500 GeV	1 TeV	5 TeV
Running width	672.96(3)	225.45(3)	62.17(1)	123.76(1)
Constant width	673.08(4)	224.05(3)	56.90(1)	2.212(6)

Extensive study of several schemes for LEP2

(no attempt at completeness, see e.g. Grünewald et.al. [hep-ph/0005309])

- Minimal modifications to standard perturbation theory
 - “Constant width”: use propagator

$$\frac{i}{p^2 - M^2 + iM\Gamma}$$

(violates gauge invariance but mostly harmless at tree level)

- running width with modified vertices, “overall factors”, ...

Extensive study of several schemes for LEP2

(no attempt at completeness, see e.g. Grünewald et.al. [hep-ph/0005309])

- Minimal modifications to standard perturbation theory
 - “Constant width”: use propagator

$$\frac{i}{p^2 - M^2 + iM\Gamma}$$

- Rearrange perturbation theory using hierarchy Γ/M :
 - Pole scheme: expand around **complex pole**
 $\mu^2 = M^2 - iM\Gamma$ of propagator

$$\mathcal{A}(s)|_{p^2 \sim M^2} = \frac{\mathcal{R}(\mu)}{p^2 - \mu^2} + \mathcal{N}(p^2)$$

(Stuart 91; Aepli, v. Oldenbrough, Wyler 93)

Extensive study of several schemes for LEP2

(no attempt at completeness, see e.g. Grünewald et.al. [hep-ph/0005309])

- Minimal modifications to standard perturbation theory
 - “Constant width”: use propagator

$$\frac{i}{p^2 - M^2 + iM\Gamma}$$

- Rearrange perturbation theory using hierarchy Γ/M :
 - Pole scheme**: expand around **complex pole** of propagator
- Take gauge invariance as guideline: **Fermion loop scheme**
 Resummation of **fermionic part** of self-energy (Beenakker et al. 96)

$$\frac{i}{p^2 - M^2 + \Sigma^{(f)}(p^2)}$$

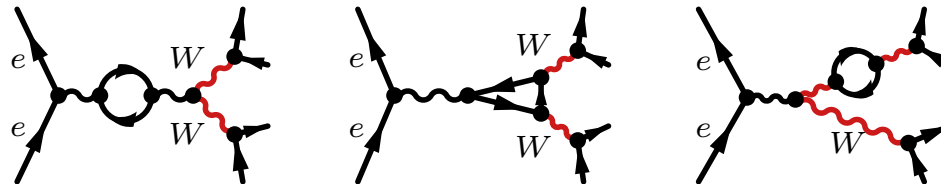

closed fermion loops form **gauge invariant subset** of diagrams

NLO calculations in double pole approximation

- **Factorizable** EW corrections to production, decay of **on-shell** W s
- **Nonfactorizable** soft photon corrections
(Berends et al. 98; Denner et al. 99)
- Implemented in Monte-Carlo programs used at LEP2: RacoonWW (Denner et al. 99), YFSWW (Jadach et al. 99)
- Estimate of DPA accuracy at NLO

$$\Delta\sigma_{\text{DPA}} \sim \frac{\Gamma_W}{M_W} \times \frac{\alpha}{\pi} \sim \mathcal{O}(0.1\%)$$

- Loss of accuracy at production threshold

$$\Delta\sigma_{\text{DPA}} \sim \frac{\Gamma_W}{\sqrt{s} - 2M_W} \times \frac{\alpha}{\pi} \sim \mathcal{O}(1\%)$$

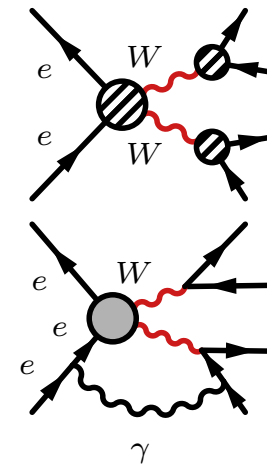

- σ_{WW} : 1%-level agreement with **NLO theory**
 RacoonWW (Denner et al.), YFSWW (Jadach et al.)
- Residual theory uncertainty $\Delta\sigma_{WW} \sim 0.5\%$
- FCCee: Luminosity increase $\times 10^4$
 Reduction of theory error to $< 0.1\%$ realistic?

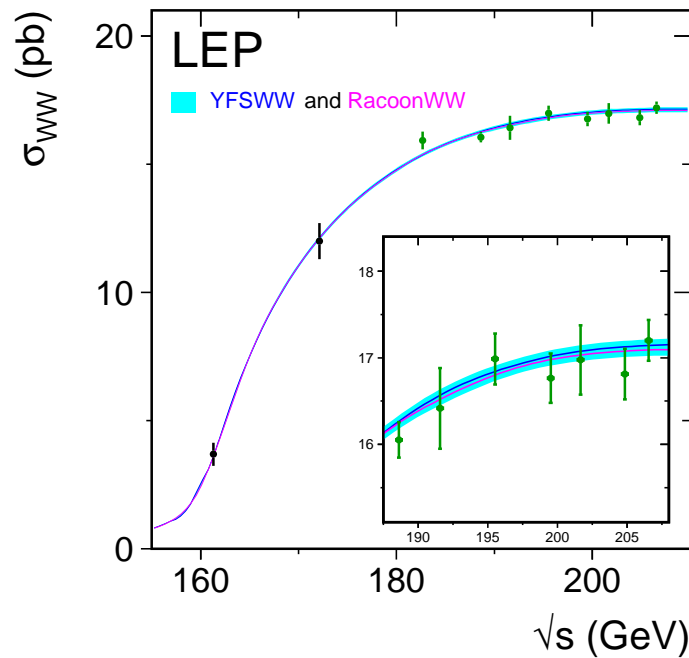
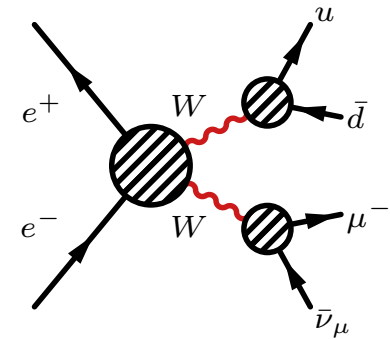

- σ_{ZZ} : Agreement with NLO QED theory in pole approximation/fermion loop scheme
YFSZZ (Jadach et al.), ZZT0 (Passarino), Gentle (Bardin et al.)
- Residual theory uncertainty $\Delta\sigma_{ZZ} \sim 2\%$
- FCCee: Accuracy $\Delta\sigma_{ZZ} < 1\%$.

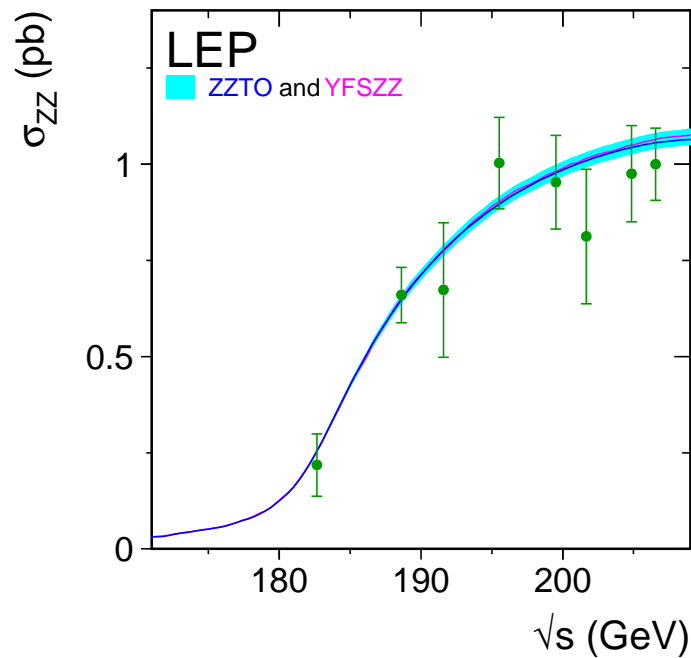
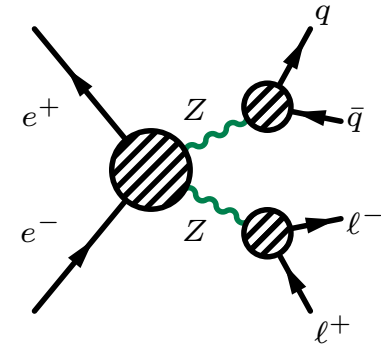

- $\sigma_{W\bar{e}e\nu}$: agreement with theory predictions in fermion-loop scheme/Born+ISR
 WPHACT (Accomando/Ballestrero), WTO (Passarino), grc4f (Fujimoto et al.)
- Forward e^- -scattering: finite m_e required, respecting gauge invariance essential
- Residual theory uncertainty $\Delta\sigma_{WW} \sim 5\%$
- FCCee: Accuracy $\Delta\sigma_{W\bar{e}e\nu} < 1\%$.

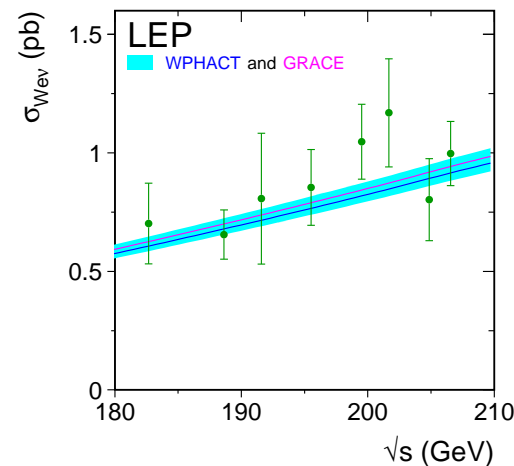
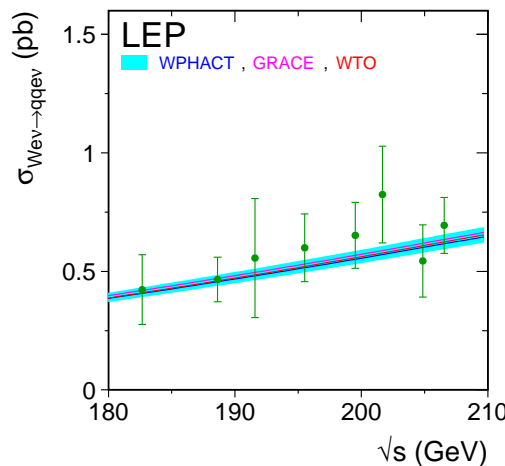
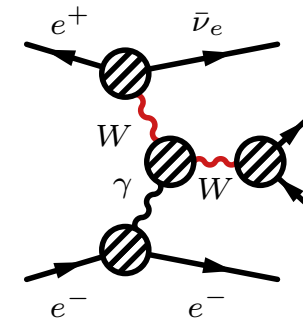

Theory developments after LEP2:

W -pair production:

- **Complete NLO** calculation for charged current $e^+e^- \rightarrow 4f$
(Denner et al. 05)
- **Log-enhanced NNLO** corrections for $\hat{s} \gg M_W$
 \Rightarrow **CLIC** (Kühn et al. 07)
- NLO and **leading NNLO** correction in threshold expansion
 \Rightarrow **ILC/FCCee** (Beneke et al. 07, Actis et al. 08)

Other results for vector-boson production in e^-e^+ :

- NLO EW corrections for **triple gauge-boson** production
 - WWZ, ZZZ (Su et al. 08; Wei et al. 09; Boudjema et al. 09)
 - $\gamma\gamma Z$ (Yu et al. 13)
 - $WW\gamma$ (Chen et al. 14)

Full NLO calculation for $e^+e^- \rightarrow 4f$ (Denner, Dittmaier, Roth, Wieders 05)

- More than 1000 1-loop diagrams
5-point, 6-point loop integrals
- ⇒ new methods for six-point diagrams
- fully differential calculation
- **complex mass scheme**: replace $M^2 \rightarrow M^2 - iM\Gamma$, **everywhere**, e.g.
 $\cos \theta_w = \frac{M_W}{M_Z}$
- DPA not sufficient at threshold and for $\sqrt{s} > 500$ GeV

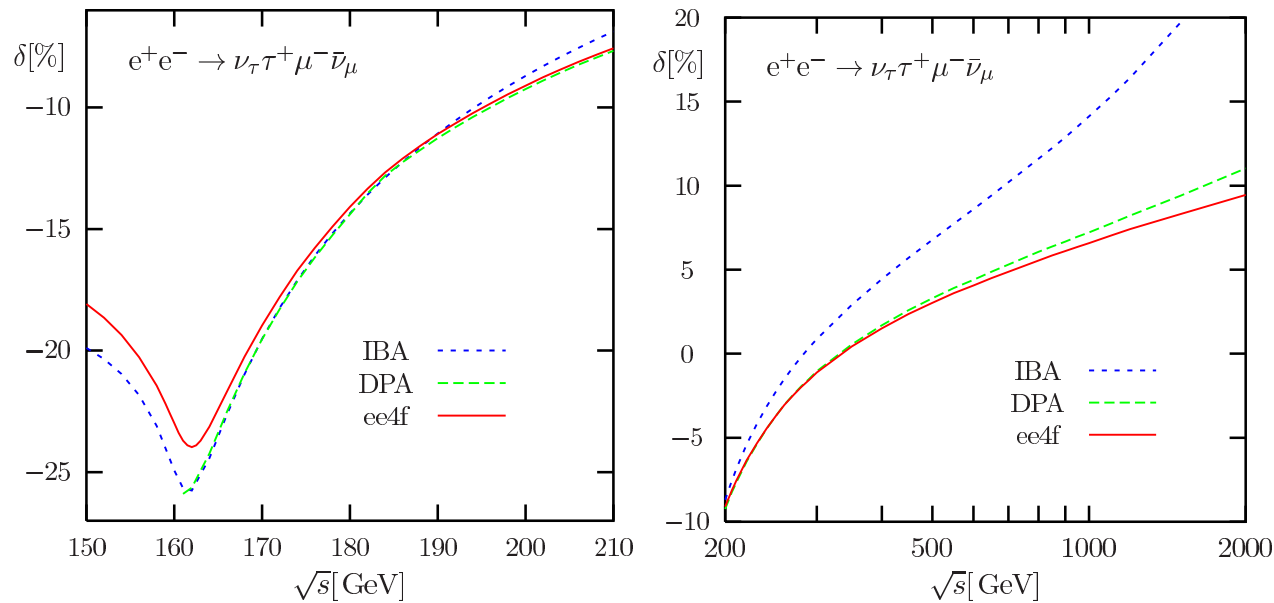
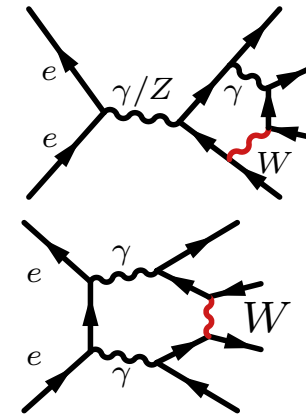

- **ILC** $\Delta M_W \lesssim 4$ MeV from threshold scan
 $\Leftrightarrow \Delta\sigma_{WW} \ll 1\%$ prediction for $\sqrt{s} \sim 160 - 170$ GeV
- **FCCee** goal $\Delta M_W < 1$ MeV
 theory uncertainty dominant!

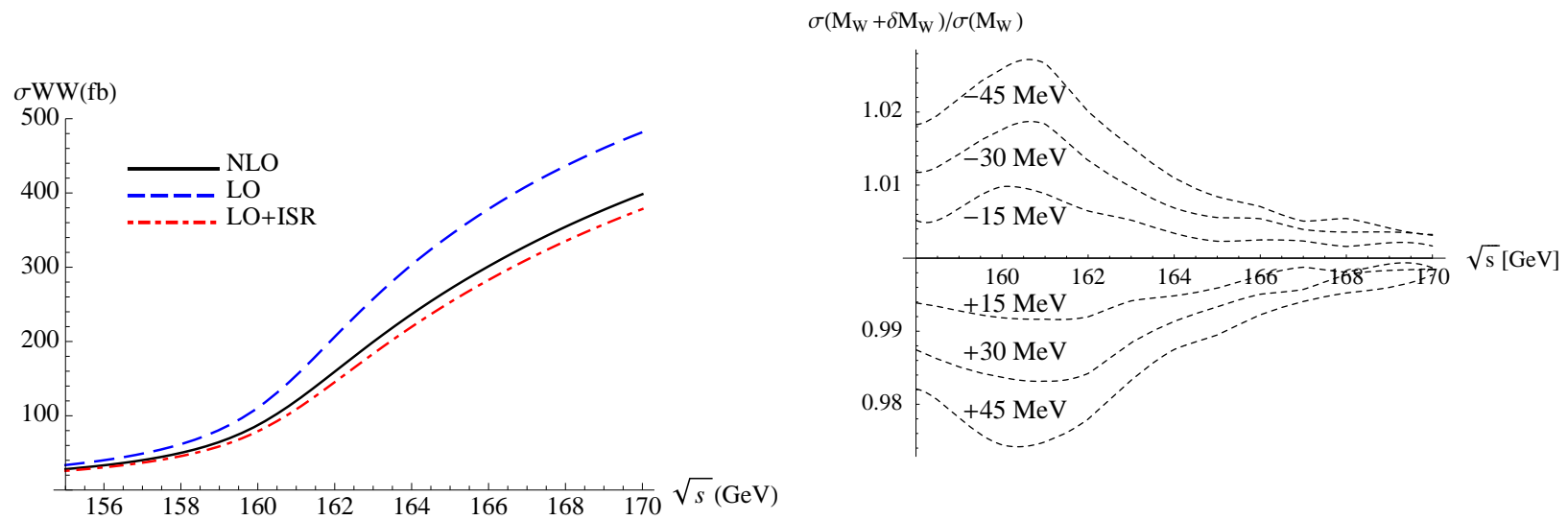

Enhanced corrections in **threshold limit** $\beta = \sqrt{1 - \frac{4M_W^2}{s}} \rightarrow 0$:

soft threshold logarithms $\sim (\alpha \log^2 \beta)^n$, **Coulomb correction** $\sim (\alpha/\beta)^n$

EFT approach:

(Beneke/Falgari/CS/Signer/Zanderighi 07)

expansion in $\alpha \sim \frac{\Gamma_W}{M_W} \sim \frac{k_W^2 - M_W^2}{M_W^2} \sim \beta$

Leading NNLO corrections

- 2nd Coulomb correction $\sim \alpha^2/\beta^2 \sim \alpha$ (Fadin et al. 95)
- Coulomb-enhanced corrections $\sim \alpha^2/\beta \sim \alpha^{3/2}$ (Actis et al. 08)
- corrections at threshold $\Delta\sigma_{WW} \sim 0.5\%$
 \Rightarrow sufficient accuracy for ILC, more work for FCCee

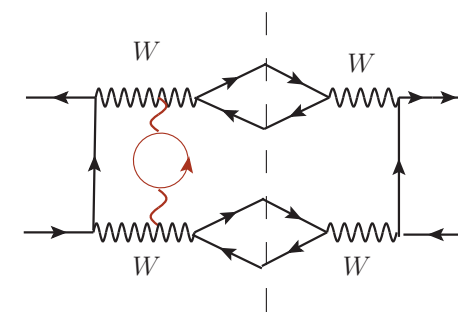
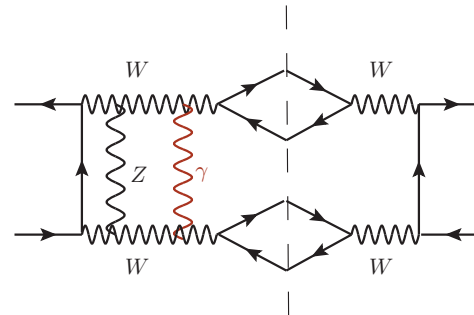
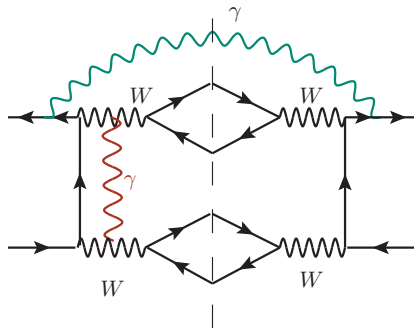

Complete NLO EW corrections for all $e^-e^+ \rightarrow 4f$ processes

- Feasible with current methods \Rightarrow accuracy $\Delta\sigma_{4f} < 1\%$ possible

(Automatization of NLO EW: Recola: Actis et al. 12; OpenLoops: Kallweit et al. 14)

NNLO?

Final words of R. Chierici at 8th FCC-ee workshop:

“Need to get to NNLO precision in α_{EW} for most processes, I am afraid”

Complete NLO EW corrections for all $e^-e^+ \rightarrow 4f$ processes

- Feasible with current methods \Rightarrow accuracy $\Delta\sigma_{4f} < 1\%$ possible

(Automatization of NLO EW: Recola: Actis et al. 12; OpenLoops: Kallweit et al. 14)

NNLO status

- NNLO QCD corrections for $pp \rightarrow VV$ at LHC (Grazzini et al. 11-14)
- Two-loop EW for $H \rightarrow \gamma\gamma$ (Passarino et al. 07)
- NNLO EW for $e^-e^+ \rightarrow VV$ more complicated;
 $e^-e^+ \rightarrow 4f$ out of reach today

Pole-approximation/EFT approach

- Pole approximation at NNLO:
 - required: NNLO for on-shell $e^-e^+ \rightarrow VV$, $V \rightarrow ff$;
 - Definition of factorizable/nonfactorizable real corrections not worked out yet.
- EFT approach for inclusive observables or near threshold
 - defined for single resonances at NNLO (Beneke et al. 04)
 - generalization to pair production at threshold appears feasible

ISR: resum leading logs

$$\beta_e = \frac{2\alpha}{\pi} \left(2 \log \left(\frac{2M_W}{m_e} \right) - 1 \right)$$

in electron structure functions:

(Skrzypek 92)

$$\sigma_{\text{NLO}}(s) = \int_0^1 dx_1 \int_0^1 dx_2 \Gamma_{ee}^{\text{LL}}(x_1) \Gamma_{ee}^{\text{LL}}(x_2) (\sigma_{\text{tree}} + \Delta\hat{\sigma}_{\text{NLO}})$$

Estimate missing NLL $\mathcal{O}(\alpha\beta_e)$:

ISR for tree only \Leftrightarrow also for NLO

Uncertainty $\sim 2\%$ at threshold

\Rightarrow NLL resummation important

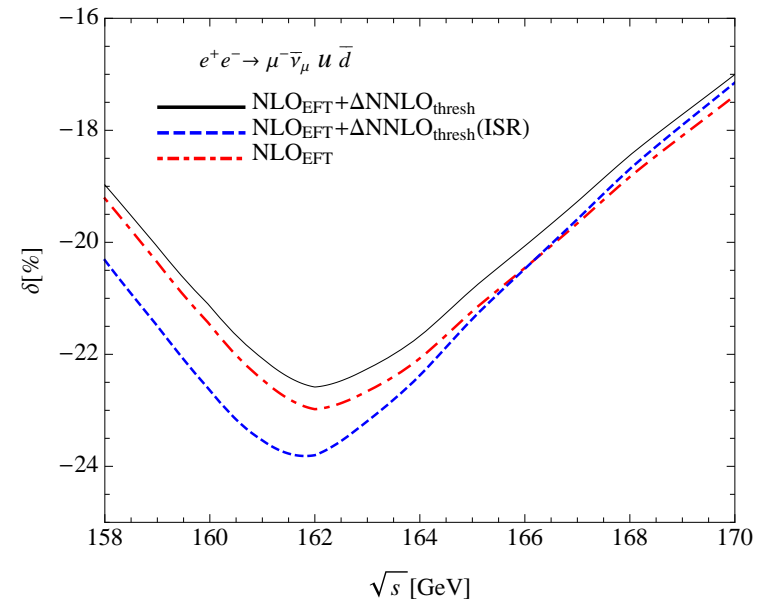

Four-fermion production

crucial process at any future e^+e^- collider

- M_W measurement from threshold or direct reconstruction
- anomalous couplings
- cross-section measurements

Full NLO EW corrections to $e^+e^- \rightarrow 4f$ (Denner et al. 05)

- accuracy of “a few 0.1%” from threshold to ~ 500 GeV.

NNLO

- Leading corrections at threshold and for large energies available (Actis et al. 08; Kühn et al. 07)
- NNLO EW for $e^-e^+ \rightarrow VV$ beyond current state-of-the-art
- Pole approximation/EFT method need to be extended to NNLO

Future e^+e^- colliders

several concepts:

- LEP3/TLEP (240-350 GeV)
- ILC (500 GeV-1TeV),
- CLIC (≤ 3 TeV)

Projected accuracy of m_W measurement:

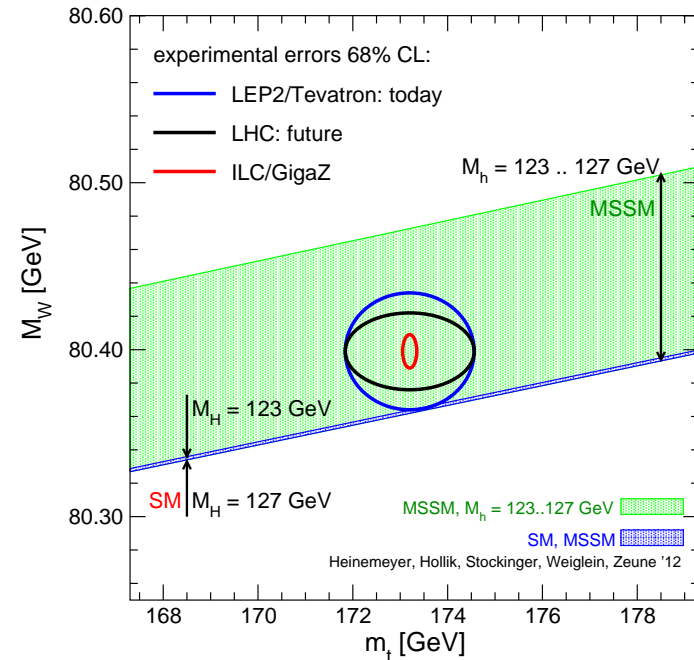

	LHC	LHC	ILC/GigaZ	ILC	ILC	ILC	TLEP	SM prediction
\sqrt{s} [TeV]	14	14	0.091	0.161	0.161	0.250	0.161	-
\mathcal{L} [fb $^{-1}$]	300	3000		100	480	500	3000 \times 4	-
ΔM_W [MeV]	8	5	-	4.1-4.5	2.3-2.9	3.6	1.2	4.2(3.0)
$\Delta \sin^2 \theta_{\text{eff}}^\ell$ [10^{-5}]	36	21	1.3	-	-	-	0.3	3.0(2.6)

(Snowmass EW report 13)

Enhanced Sudakov logarithms for high energies $s \gg M_W^2$

(Fadin et al. 00; Melles 01; Denner et al. 03; Beccaria et al. 03)

$$\underbrace{(\alpha \log^2(s/M_W^2))^n}_{\text{LL}}, \quad \underbrace{\alpha^n \log^{2n-1}(s/M_W^2)}_{\text{NLL}}, \quad \underbrace{\alpha^n \log^{2n-2}(s/M_W^2)}_{\text{NNLL}} \dots$$

- NNLO-NNLL corrections for on-shell W -pair production:

$\sim 5\%(s = 1 \text{ TeV}) - 15\%(s = 3 \text{ TeV})$

(Kühn/Penin/Metzler 07)

\Rightarrow need to be taken into account at CLIC and 2nd phase of ILC

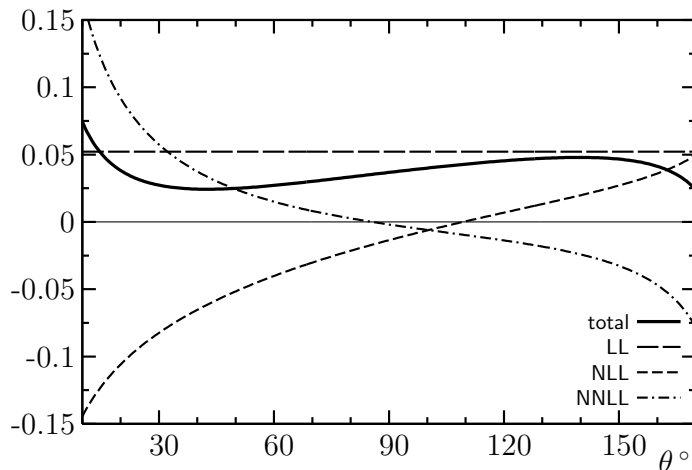

(transverse polarization)

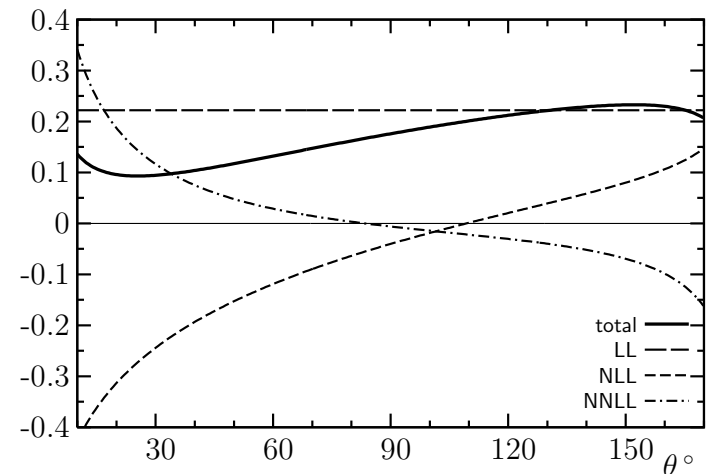

1 TeV

3 TeV

Pole scheme: (Stuart 91; Aepli/v.Oldenbourgh/Wyler 93) expand around **complex pole** of propagator $\mu^2 = M^2 + iM\Gamma$

$$\mathcal{A}(s) = \frac{R(s)}{s - M^2 + \Sigma(s)} + N(s)$$

$$= \underbrace{\frac{R(\mu^2)}{s - \mu^2} \frac{1}{1 + \Sigma'(\mu^2)}}_{\text{factorizable corrections}} + \underbrace{\left[\frac{R(s)}{s - M^2 + \Sigma(s)} - \frac{R(\mu^2)}{s - \mu^2} \frac{1}{1 + \Sigma'(\mu^2)} \right]}_{\text{non-factorizable corrections}} \Bigg|_{s \rightarrow \mu^2} + \text{non-res.}$$

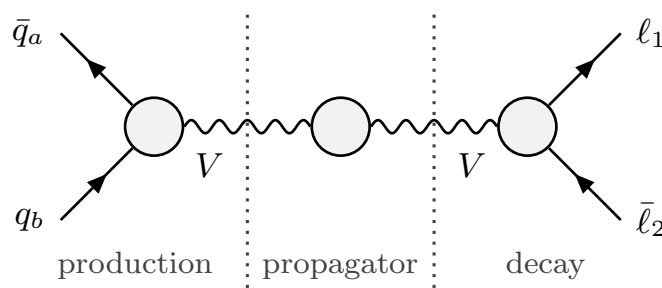

factorizable corrections to on-shell prod. and decay

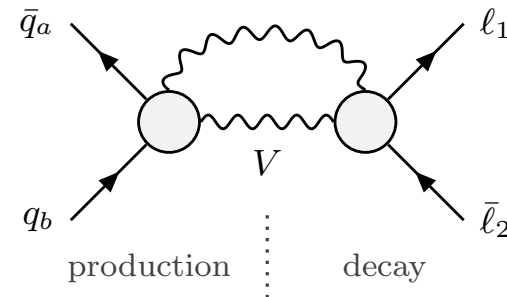

non-fact. soft-photon corrections

Real corrections:

Factorizable corrections to on-shell production and decay:

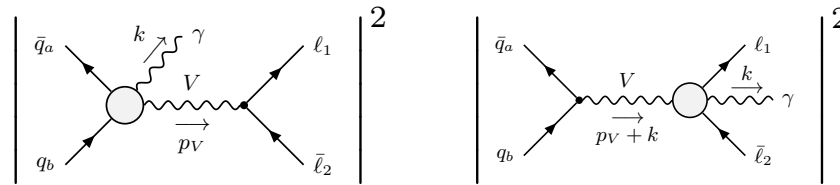

Non-fact. corrections: resonance enhancement from **soft photons**

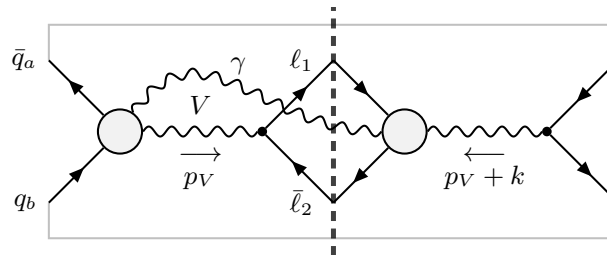

Applications of pole scheme

- Drell-Yan processes (Wackerth/Hollik 96)
- Generalization to pair production:
 - $e^+e^- \rightarrow W^+W^- \rightarrow 4f$ (Berends et. al. 98; Denner et.al. 99)