



The Next Generation of Crystal Detectors

Ren-Yuan Zhu

California Institute of Technology

May 29, 2015



Why Crystal Calorimeter in HEP?



- **Photons and electrons are fundamental particles. Precision e/γ measurements enhance physics discovery potential for future HEP experiments.**
- **Performance of crystal calorimeter in e/γ measurements is well understood:**
 - The best possible energy resolution;
 - Good position resolution;
 - **Good e/γ identification and reconstruction efficiency.**
- **Challenges at future HEP Experiments:**
 - Radiation damage at the energy frontier (HL-LHC);
 - Ultra-fast rate at the intensity frontier;
 - **Good jet mass resolution at the energy frontier (ILC/CLIC).**



Physics with Crystal Calorimeters (II)



Charmonium system observed by CB through Inclusive photons

Higgs $\rightarrow \gamma\gamma$ by CMS through reconstructing photon pairs

CB NaI(Tl)

CMS PWO

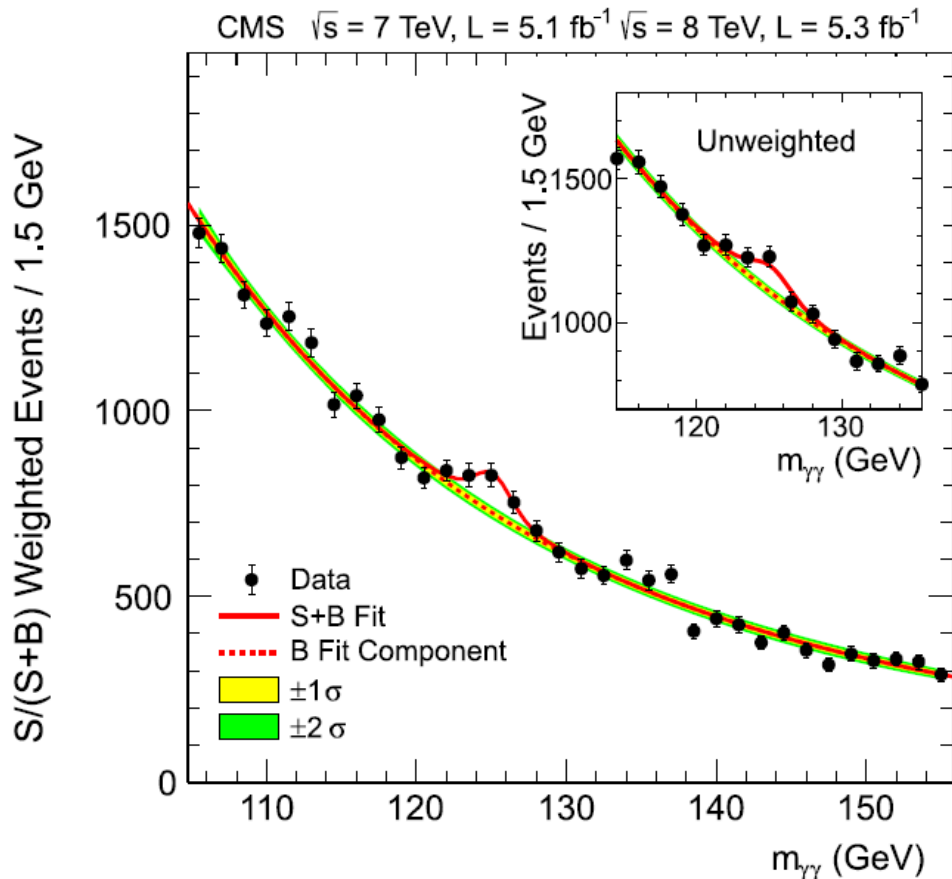
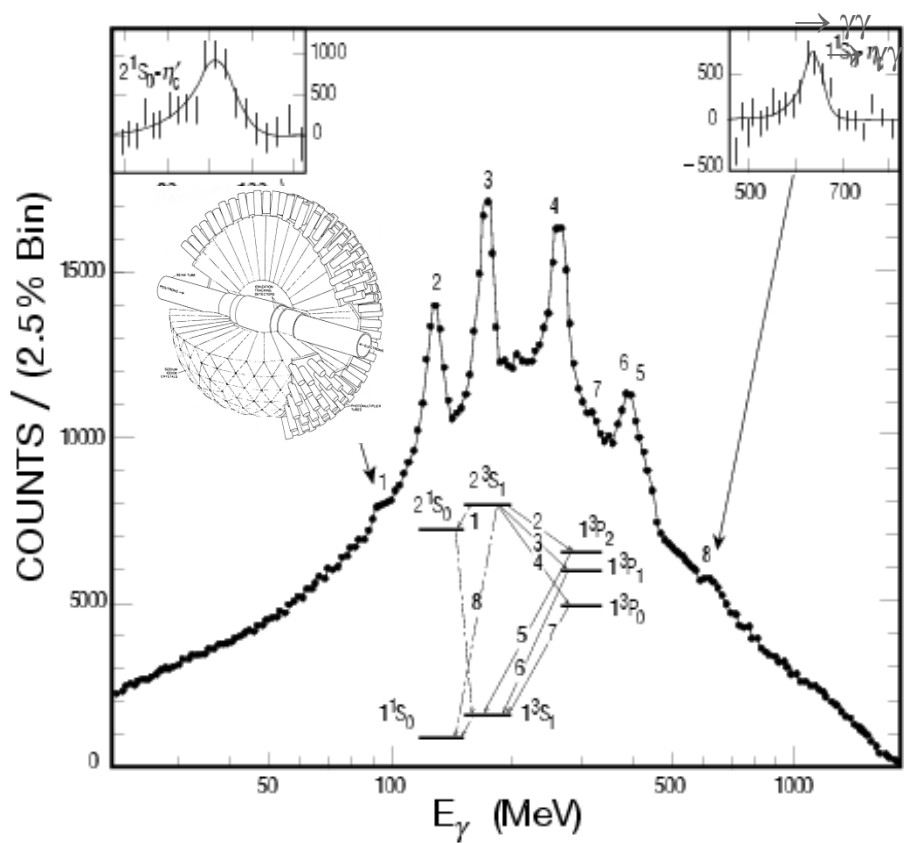



Existing Crystal Calorimeters



Date	75-85	80-00	80-00	80-00	90-10	94-10	94-10	95-20
Experiment	C. Ball	L3	CLEO II	C. Barrel	KTeV	<i>BaBar</i>	BELLE	CMS
Accelerator	SPEAR	LEP	CESR	LEAR	FNAL	SLAC	KEK	CERN
Crystal Type	NaI(Tl)	BGO	CsI(Tl)	CsI(Tl)	CsI	CsI(Tl)	CsI(Tl)	PbWO ₄
B-Field (T)	-	0.5	1.5	1.5	-	1.5	1.0	4.0
r_{inner} (m)	0.254	0.55	1.0	0.27	-	1.0	1.25	1.29
Number of Crystals	672	11,400	7,800	1,400	3,300	6,580	8,800	76,000
Crystal Depth (X_0)	16	22	16	16	27	16 to 17.5	16.2	25
Crystal Volume (m ³)	1	1.5	7	1	2	5.9	9.5	11
Light Output (p.e./MeV)	350	1,400	5,000	2,000	40	5,000	5,000	2
Photosensor	PMT	Si PD	Si PD	WS ^a +Si PD	PMT	Si PD	Si PD	APD ^a
Gain of Photosensor	Large	1	1	1	4,000	1	1	50
σ_N /Channel (MeV)	0.05	0.8	0.5	0.2	small	0.15	0.2	40
Dynamic Range	10 ⁴	10 ⁵	10 ⁴	10 ⁴	10 ⁴	10 ⁴	10 ⁴	10 ⁵

Future Crystal Calorimeters in HEP:
 LYSO for COMET (Mu2e, Super B) and CMS at HL-LHC
 BaF₂ and PbF₂ for Mu2e and g-2 respectively at Fermilab
 PbF₂, PbFCl and BSO for Homogeneous HCAL for ILC



CMS Experiment at LHC

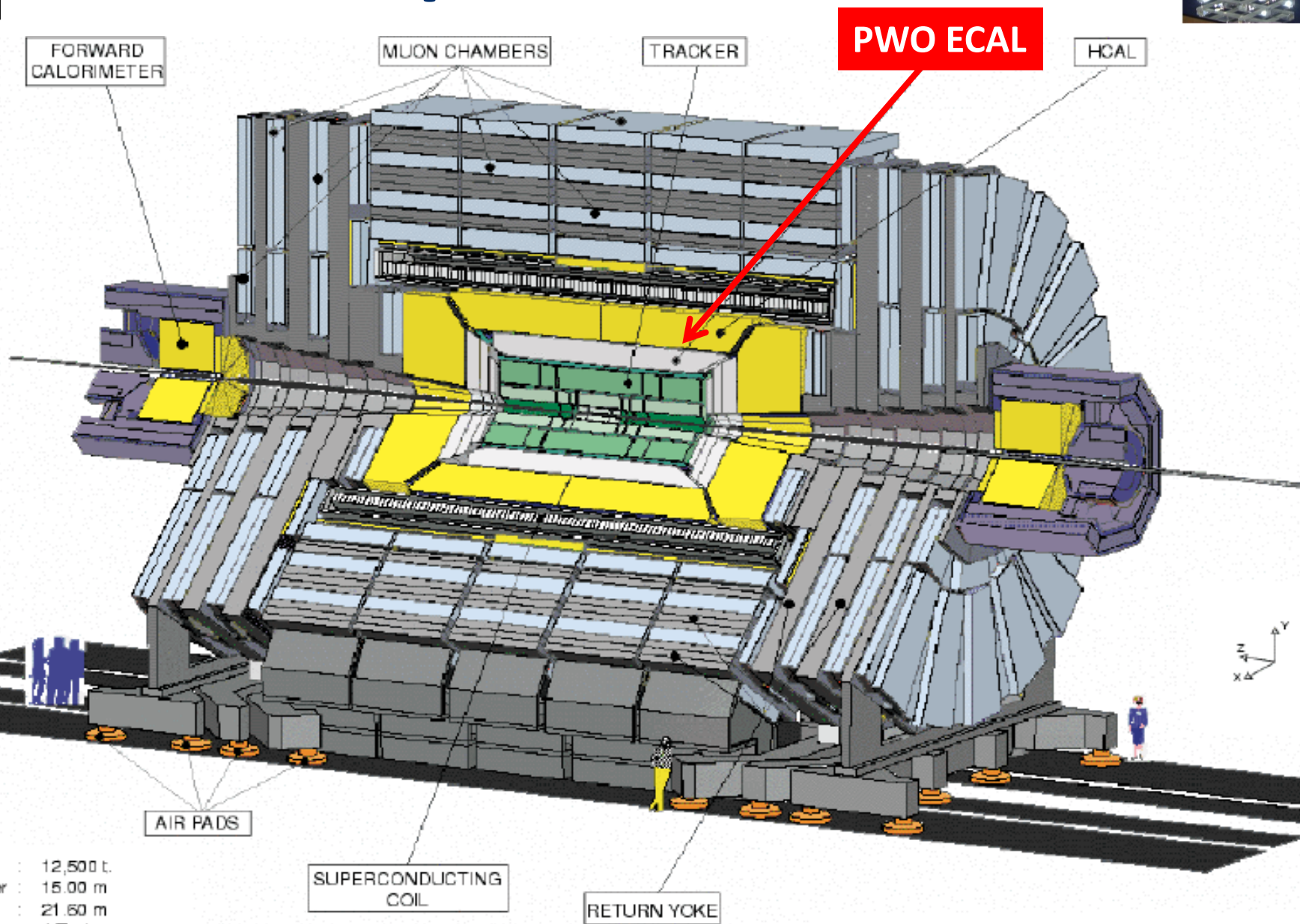
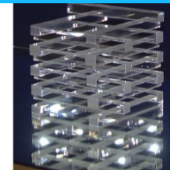

Total weight : 12,500 t.
Overall diameter : 15.00 m
Overall length : 21.60 m
Magnetic field : 4 Tesla



CMS PWO Monitoring Response



The observed degradation is well understood

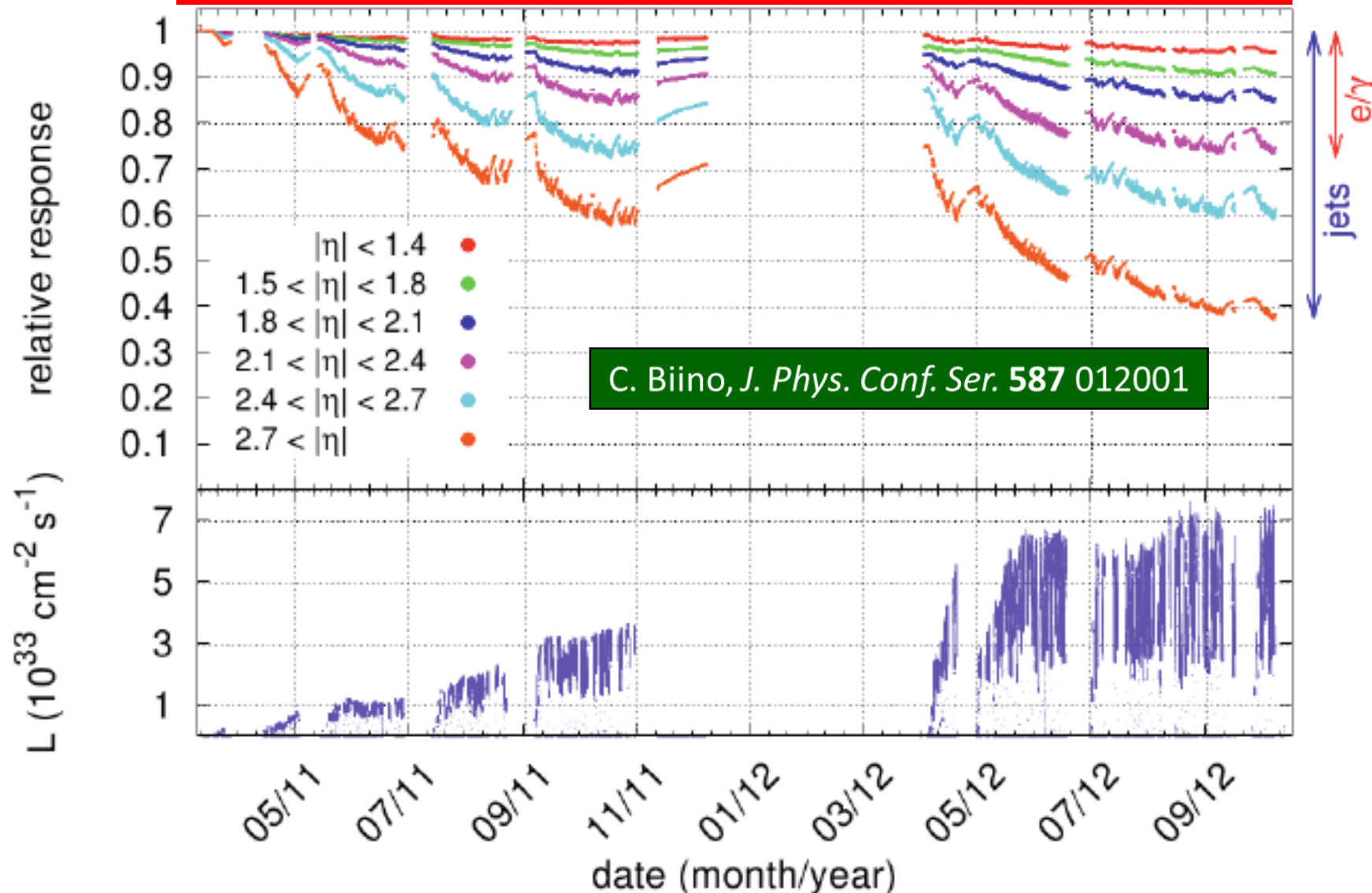



Dose Rate Dependent Damage in LO



IEEE Trans. Nucl. Sci., Vol. 44 (1997) 458-476

Light output reaches an equilibrium during irradiations under a defined dose rate, showing dose rate dependent radiation damage

$$dD = \sum_{i=1}^n \{-a_i D_i dt + (D_i^{all} - D_i) b_i R dt\}$$

$$D = \sum_{i=1}^n \left\{ \frac{b_i R D_i^{all}}{a_i + b_i R} [1 - e^{-(a_i + b_i R)t}] + D_i^0 e^{-(a_i + b_i R)t} \right\}$$

- D_i : color center density in units of m^{-1} ;
- D_i^0 : initial color center density;
- D_i^{all} is the total density of trap related to the color center in the crystal;
- a_i : recovery constant in units of hr^{-1} ;
- b_i : damage constant in units of $kRad^{-1}$;
- R : the radiation dose rate in units of $kRad/hr$.

$$D_{eq} = \sum_{i=1}^n \frac{b_i R D_i^{all}}{a_i + b_i R}$$

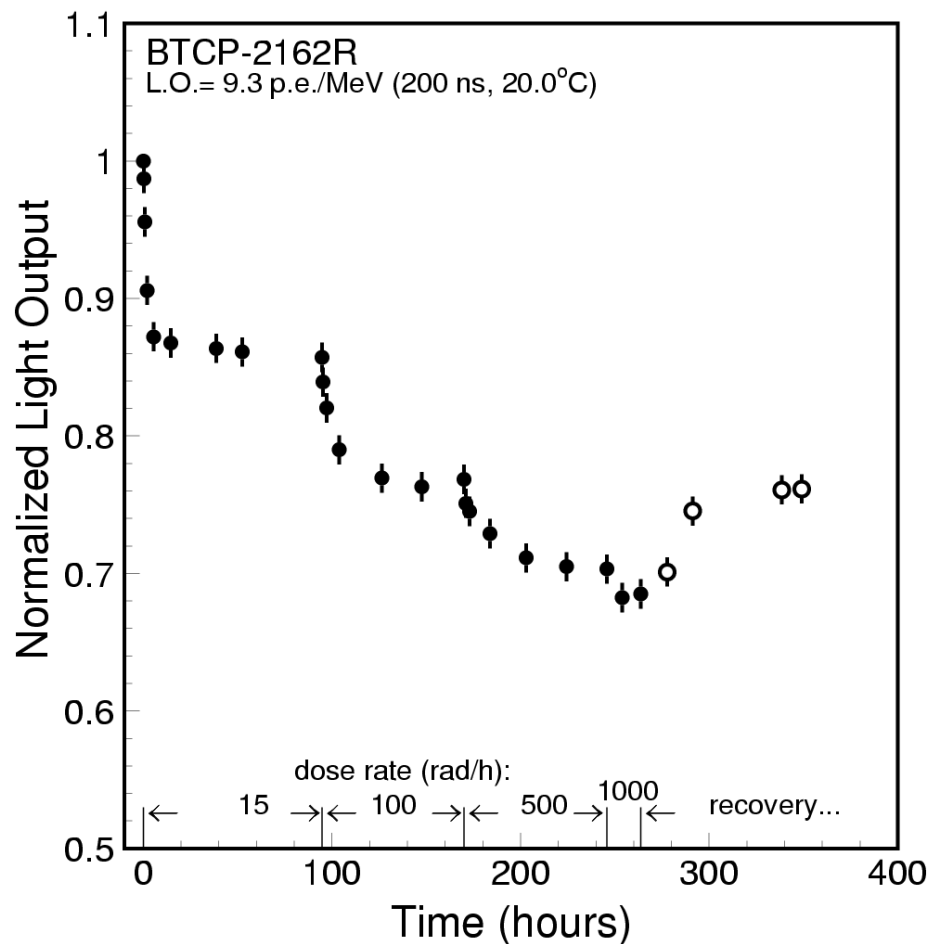



Oxygen Vacancies Identified by TEM/EDS



5 to 10 nm black spots identified by TOPCON-002B scope, 200 kV, 10 μ A
 Localized stoichiometry analysis by JEOL JEM-2010 scope and Link ISIS EDS

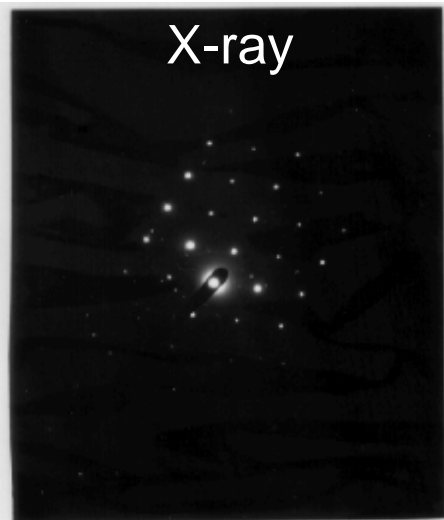

X-ray



Good PWO

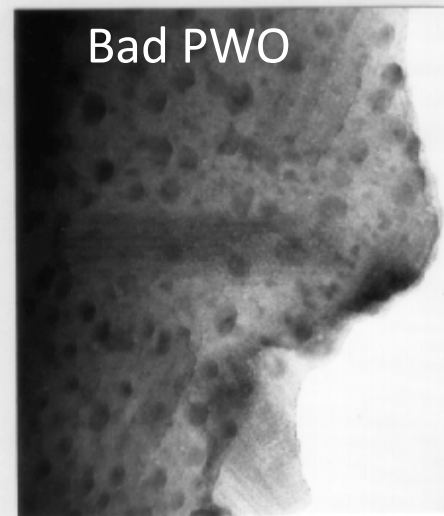

Bad PWO

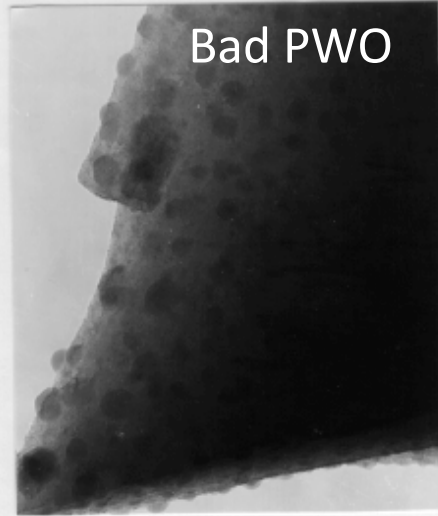

Bad PWO

NIM A413 (1998) 297

Atomic Fraction (%) in PbWO_4

As Grown Sample

Element	Black Spot	Peripheral	Matrix ₁	Matrix ₂
O	1.5	15.8	60.8	63.2
W	50.8	44.3	19.6	18.4
Pb	47.7	39.9	19.6	18.4

The Same Sample after Oxygen Compensation

Element	Point ₁	Point ₂	Point ₃	Point ₄
O	59.0	66.4	57.4	66.7
W	21.0	16.5	21.3	16.8
Pb	20.0	17.1	21.3	16.5



Prediction of PWO Radiation Damage



IEEE Trans. Nucl. Sci. NS-51 1777 (2004)

Talk in CMS Forward Calorimeter Taskforce Meeting, CERN, 12/10/2010

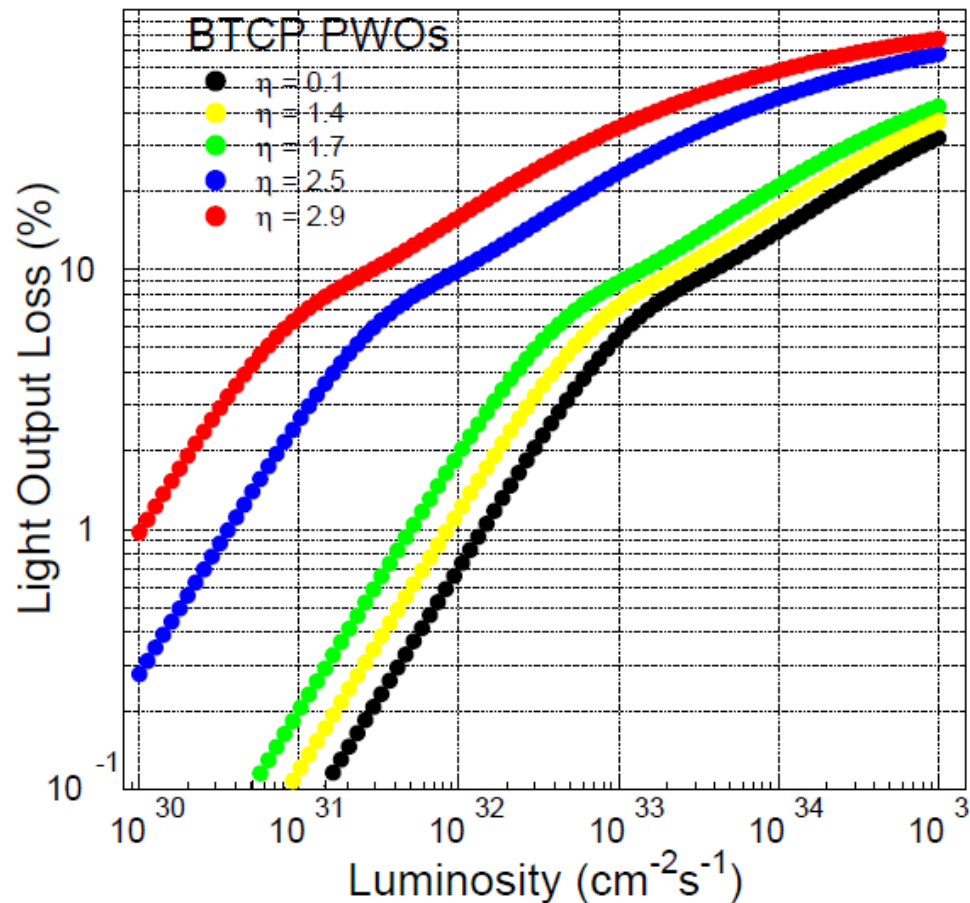
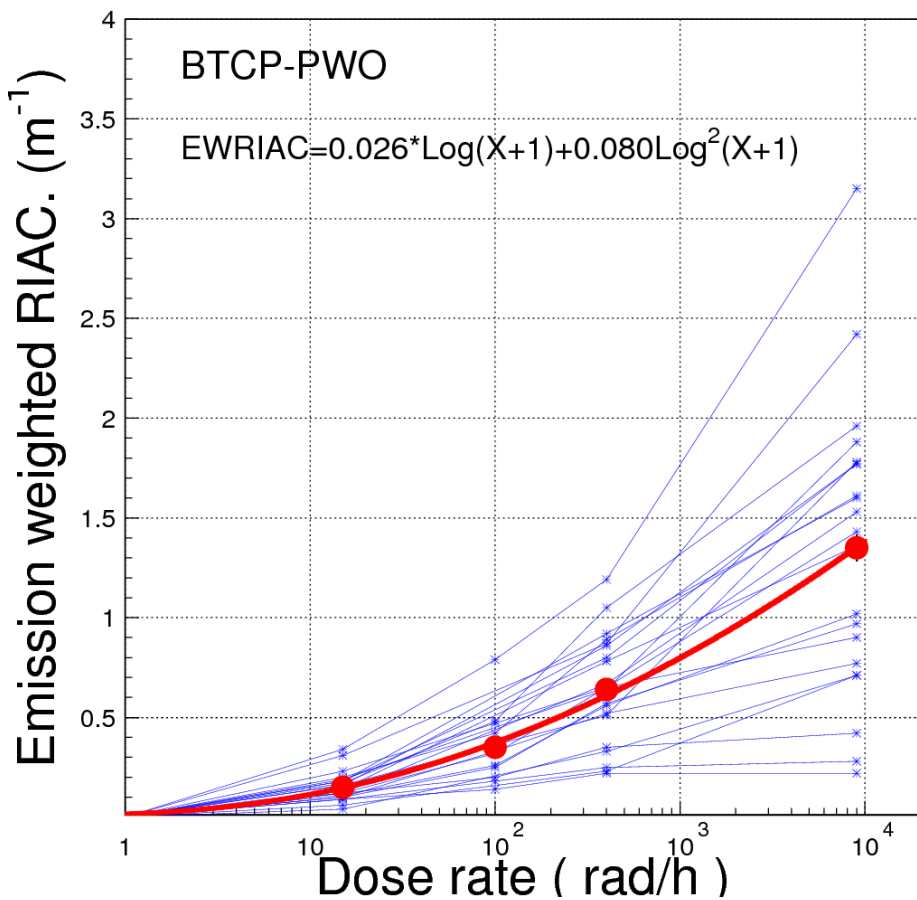

Predicted EM dose induced damage agrees well with the LHC data
In addition, there is cumulative hadron induced damage in PWO

Proton Induced Damage in PWO



G. Dissertori et al., NIMA 745 (2014)

C. Biino, *J. Phys. Conf. Ser.* 587 012001

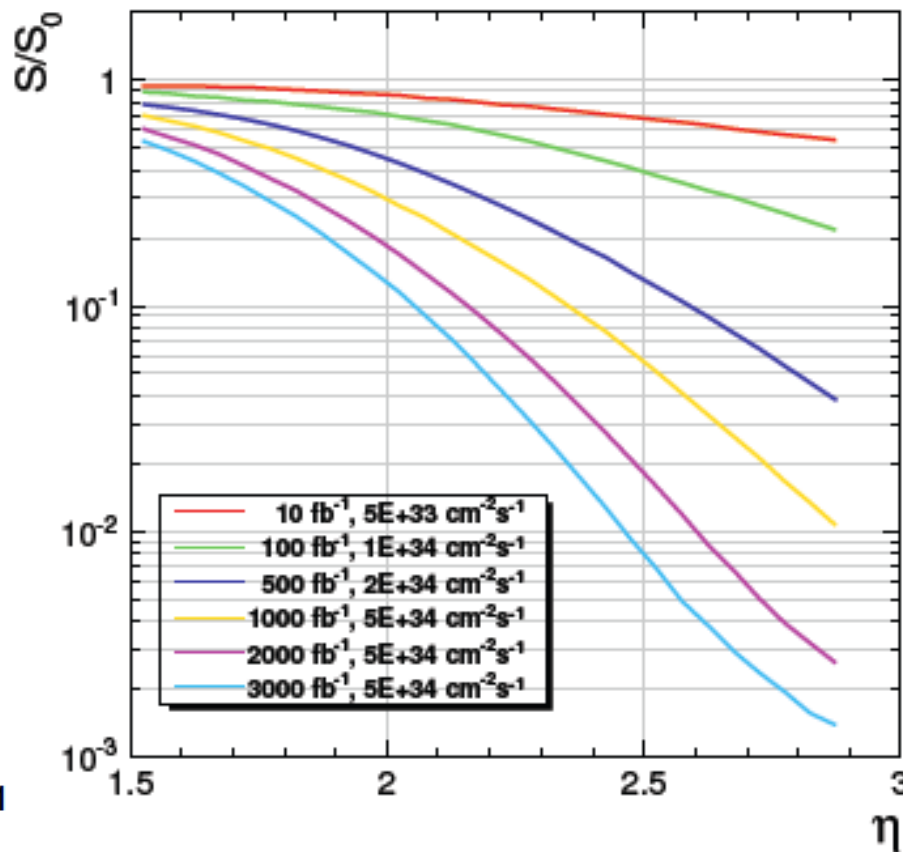
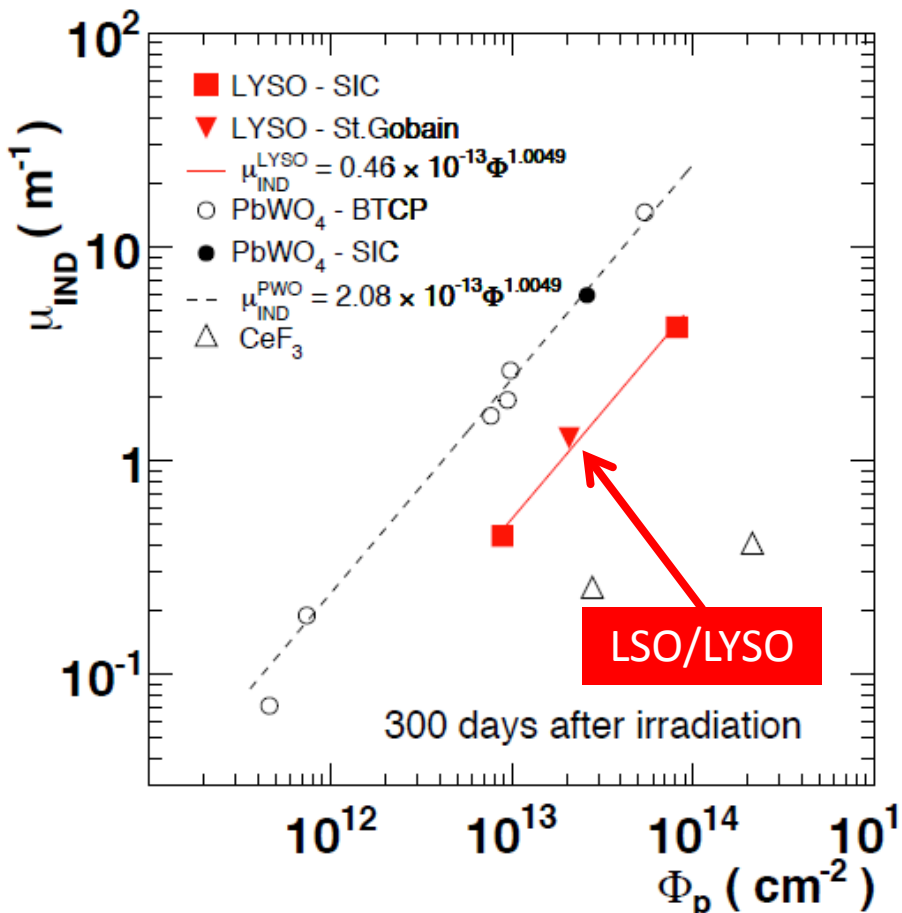

Expected LO loss would be very large for PWO
 Proton induced absorption in LYSO is 1/5 of PWO



Hadron Fluence @ 3,000 fb⁻¹



Expected neutral and charged hadron fluence is $5 \times 10^{15}/\text{cm}^2$ and $3 \times 10^{14}/\text{cm}^2$ respectively for the proposed Shashlik endcap at $|\eta| = 3$

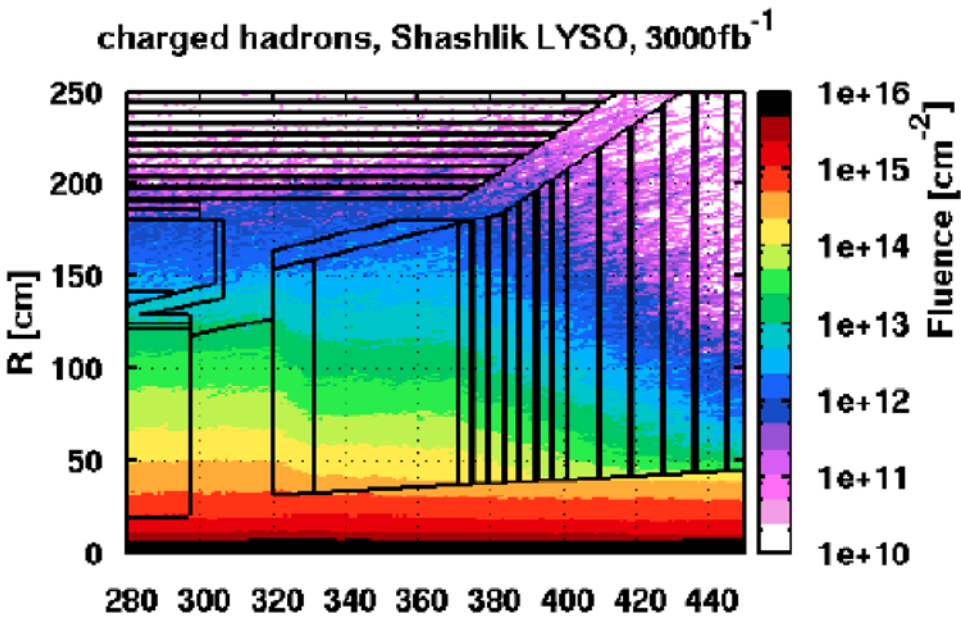
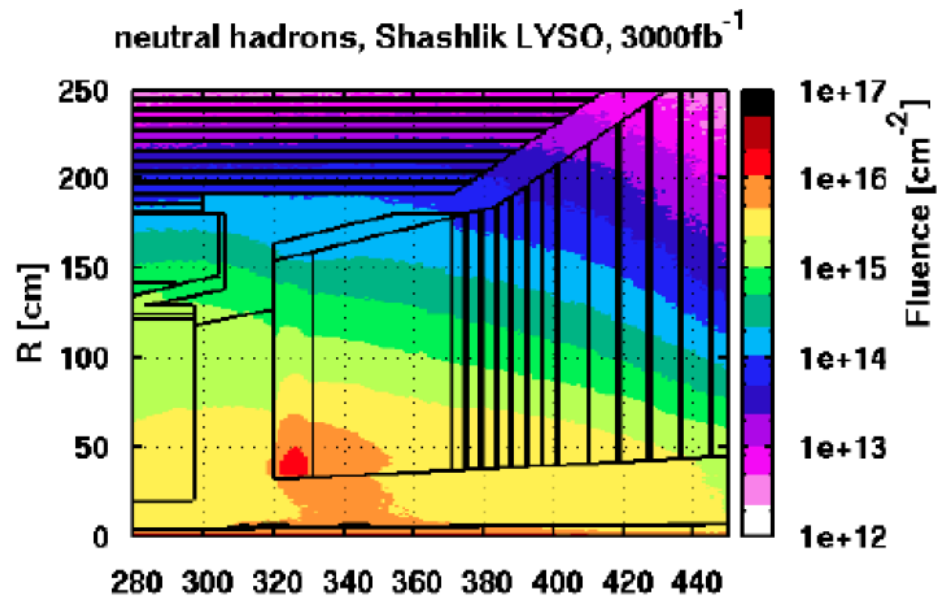

No experimental data show that hadrons (charged or neutral) of > 20 MeV would damage scintillators equally, so they are treated separately



Expected Fluence from FLUKA



CMS Radiation	LHC ($10^{34} \text{ cm}^{-2} \text{ s}^{-1}$, 500 fb^{-1})		HL-LHC ($5 \times 10^{34} \text{ cm}^{-2} \text{ s}^{-1}$, 3000 fb^{-1})	
	Barrel (max)	Endcap (max)	Barrel (max)	Endcap (max)
Absorbed dose (rad)	3.50E+05	2.10E+07	2.10E+06	1.26E+08
Dose rate (rad/h)	25	1512	126	7560
Fast neutrons fluence ($E > 100 \text{ KeV}$, cm^{-2})	3.00E+13	8.00E+14	1.80E+14	4.80E+15
Fast neutrons flux ($E > 100 \text{ KeV}$, $\text{cm}^{-2} \text{ s}^{-1}$)	6.00E+05	1.60E+07	3.00E+06	8.00E+07
Charged hadrons fluence (cm^{-2})	4.00E+11	5.00E+13	2.40E+12	3.00E+14
Charged hadrons flux ($\text{cm}^{-2} \text{ s}^{-1}$)	8.00E+03	1.00E+06	4.00E+04	5.00E+06

γ -rays: Up to 130 Mrad at 7.6 krad/h, See [1] and [2]
Fast Neutrons: Up to $5 \times 10^{15} \text{ n/cm}^2$ at $8 \times 10^7 \text{ n/cm}^2/\text{s}$
Charged hadrons: Up to $3 \times 10^{14} \text{ p/cm}^2$ at $5 \times 10^6 \text{ p/cm}^2/\text{s}$



Energy Spectra Expected at HL-LHC



The peak energy of charged hadrons at CMS endcap is hundreds MeV
Proton energy used for irradiations: 67 MeV/800 MeV/24 GeV @ Davis/LANL/CERN
Neutron energy used in irradiation: 2.5 MeV from a pair of Cf-252 source

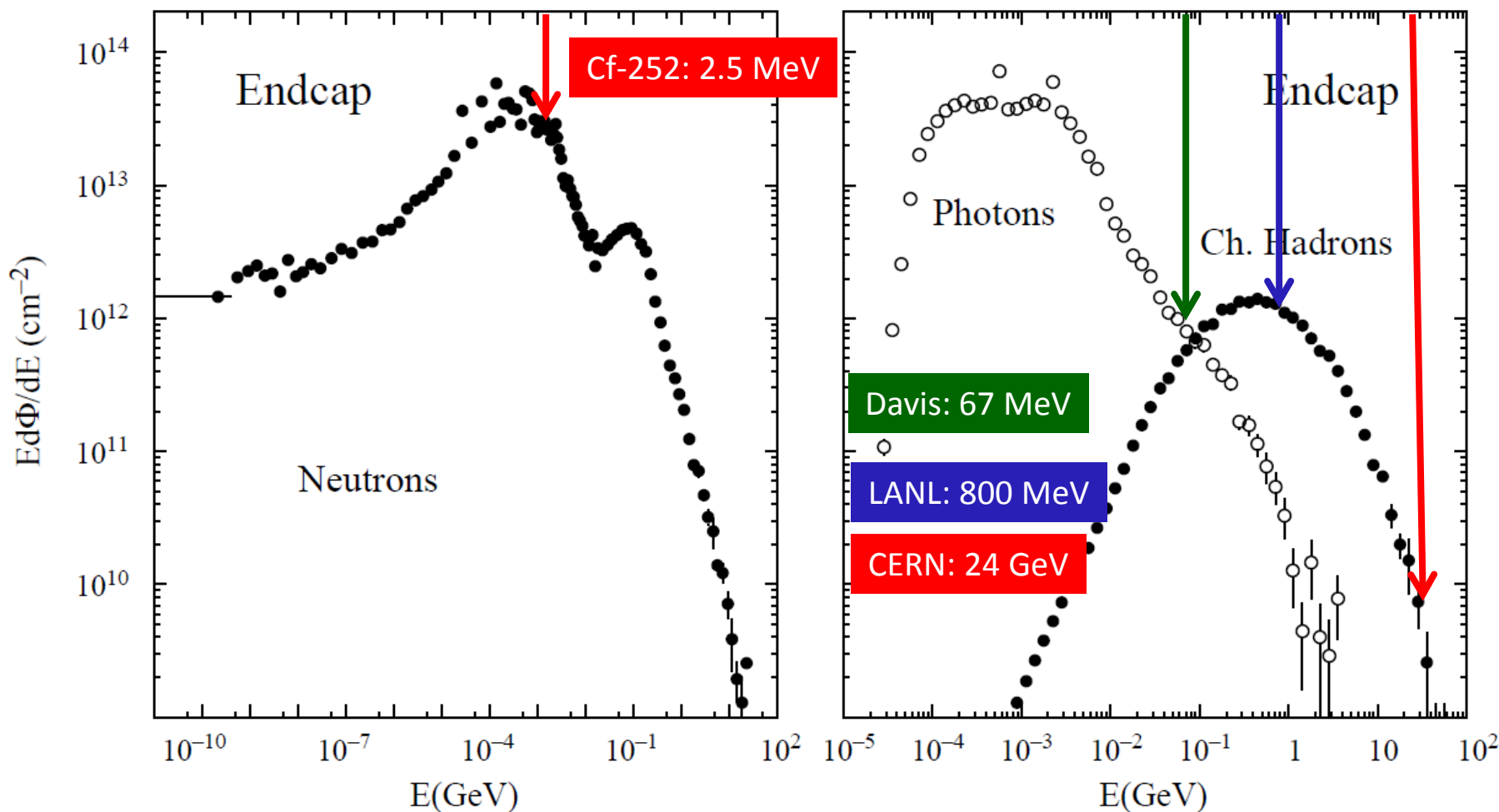



No Neutron Damage in PWO



5.2 Radiation damage effects under neutron irradiation

In view of the intense neutron flux expected in CMS (see section 2) the effects on lead tungstate of neutron exposure were studied in nuclear reactors [47, 48]. The neutron fluxes and energies in these exposures were comparable to those expected in CMS. However, in reactors there is a strong associated gamma dose. The effect arising from neutrons was estimated by comparing the reactor results with results obtained from pure gamma irradiations. This indicated that there was no specific effect due to neutrons on the optical and scintillating properties of lead tungstate, at least up to fluences of 10^{14} cm^{-2} . This was confirmed by later independent studies [49]. It is also to be mentioned that recent tests performed at a very high fluence, of the order of 10^{19} to $10^{20} \text{ n}\cdot\text{cm}^{-2}$ and 330 MGy (i.e. well above the level that will be ever achieved in any physics experiment) revealed the robustness of lead tungstate crystals which were not destroyed nor locally vitrified, and remained scintillating after such heavy irradiation [50].

The CMS Electromagnetic Calorimeter Group, *Radiation hardness qualification of PbWO_4 scintillation crystals for the CMS Electromagnetic Calorimeter*, 2010 JINST 5 P03010



A Saclay Paper on Neutron Damage to 10^{19} n/cm²



Gamma Irradiation at JPL

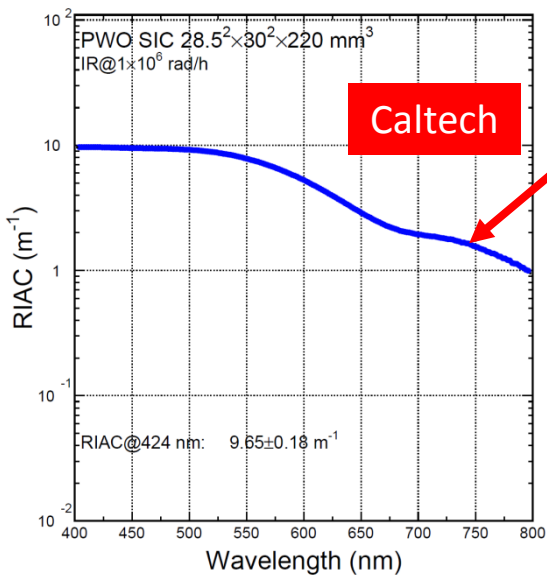
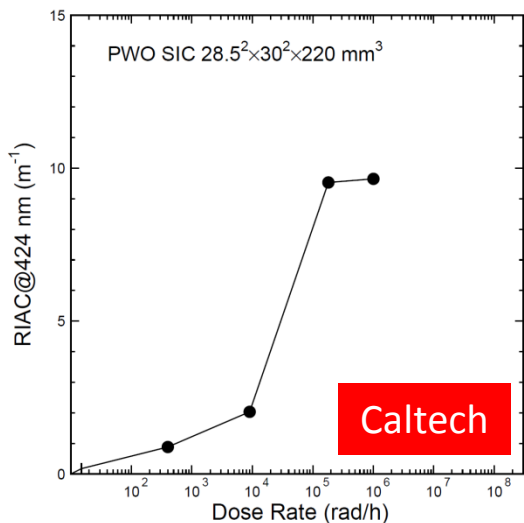

7.8E18/1.2E19/4.0E19 n/cm² for fast/epithermal/thermal n
 The dose received is estimated to 330E8 rad (3E8 rad/h)

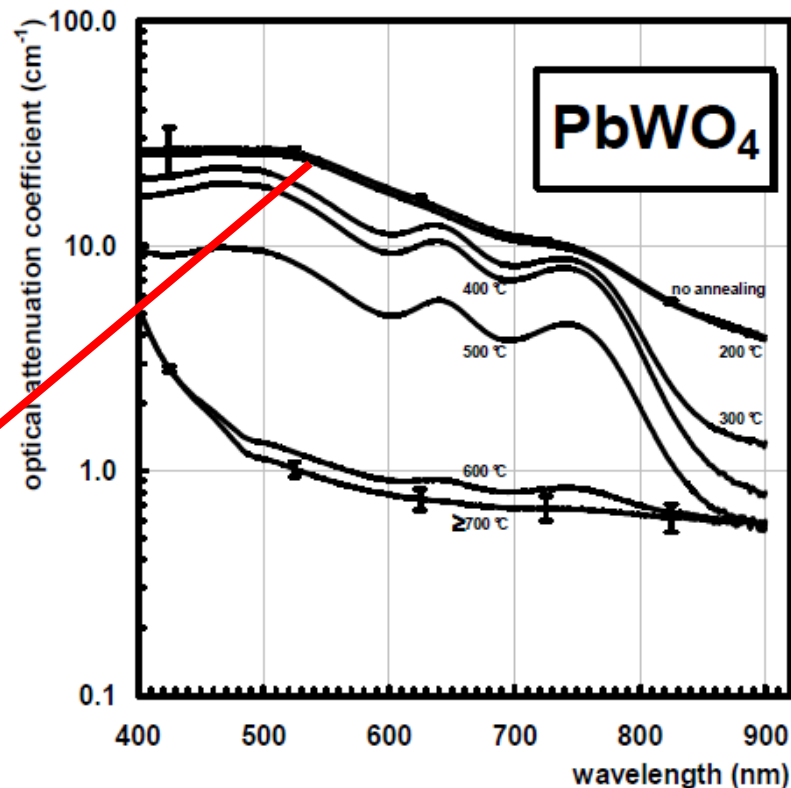

Fig. 2. Optical attenuation coefficient of the irradiated sample before annealing and after successive annealing temperatures.

[50] R. Chipaux et al., *Behaviour of PWO scintillators after high fluence neutron irradiation*, in Proc. 8th Int. Conference on Inorganic Scintillators, SCINT2005, A. Getkin and B. Grinyov eds, Alushta, Crimea, Ukraine, September 19–23 (2005), pp. 369–371



Bright, Fast Scintillator: LSO/LYSO



Crystal	Nal(Tl)	CsI(Tl)	CsI	BaF ₂	BGO	LYSO(Ce)	PWO	PbF ₂
Density (g/cm ³)	3.67	4.51	4.51	4.89	7.13	7.40	8.3	7.77
Melting Point (°C)	651	621	621	1280	1050	2050	1123	824
Radiation Length (cm)	2.59	1.86	1.86	2.03	1.12	1.14	0.89	0.93
Molière Radius (cm)	4.13	3.57	3.57	3.10	2.23	2.07	2.00	2.21
Interaction Length (cm)	42.9	39.3	39.3	30.7	22.8	20.9	20.7	21.0
Refractive Index ^a	1.85	1.79	1.95	1.50	2.15	1.82	2.20	1.82
Hygroscopicity	Yes	Slight	Slight	No	No	No	No	No
Luminescence ^b (nm) (at peak)	410	550	310	300 220	480	402	425 420	?
Decay Time ^b (ns)	245	1220	26	650 0.9	300	40	30 10	?
Light Yield ^{b,c} (%)	100	165	3.7	36 4.1	21	85	0.3 0.1	?
d(LY)/dT ^b (%/°C)	-0.2	0.4	-1.4	-1.9 0.1	-0.9	-0.2	-2.5	?
Experiment	Crystal Ball	BaBar BELLE BES III	KTev	(GEM) TAPS Mu2e	L3 BELLE EIC?	Comet {Mu2e,SuperB} CMS?	CMS ALICE PANDA	A4 g-2 HHCAL?

a. at peak of emission; b. up/low row: slow/fast component; c. QE of readout device taken out.



Bright, Fast & Rad Hard LYSO

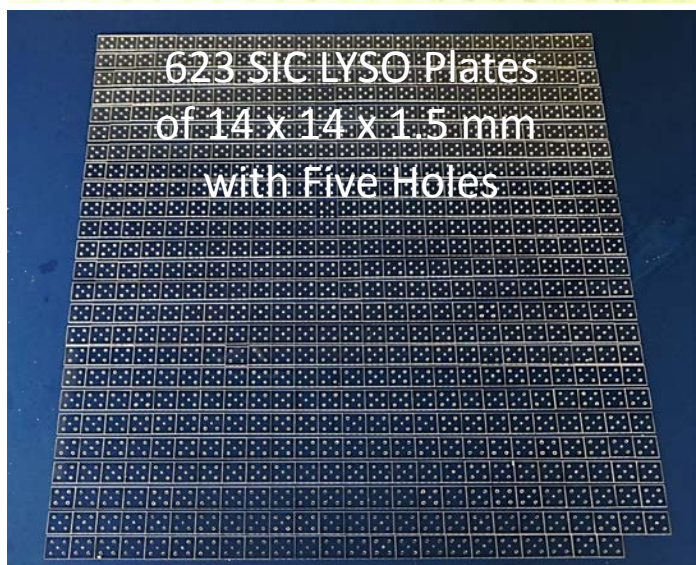

- LYSO is a bright (200 times of PWO), fast (40 ns) and radiation hard crystal scintillator.
- No variation in emission spectrum was observed after γ -rays irradiation, indicating scintillation mechanism is not damaged.
- γ -ray induced radiation damage in LYSO does not recover at room temperature, indicating a stable calorimeter *in situ*.
- γ -ray induced absorption coefficient measured for 20 cm long LYSO crystals after 200 Mrad irradiation is about 2 m^{-1} .
- γ -ray induced light output loss measured for 14 x 14 x 1.5 mm plates after 100 and 200 Mrad irradiation is about 6 and 8% respectively.
- The material is widely used in the medical industry with existing mass production capability.



γ -Ray Induced Damage in LYSO



No damage in scintillation

No recovery in room temperature

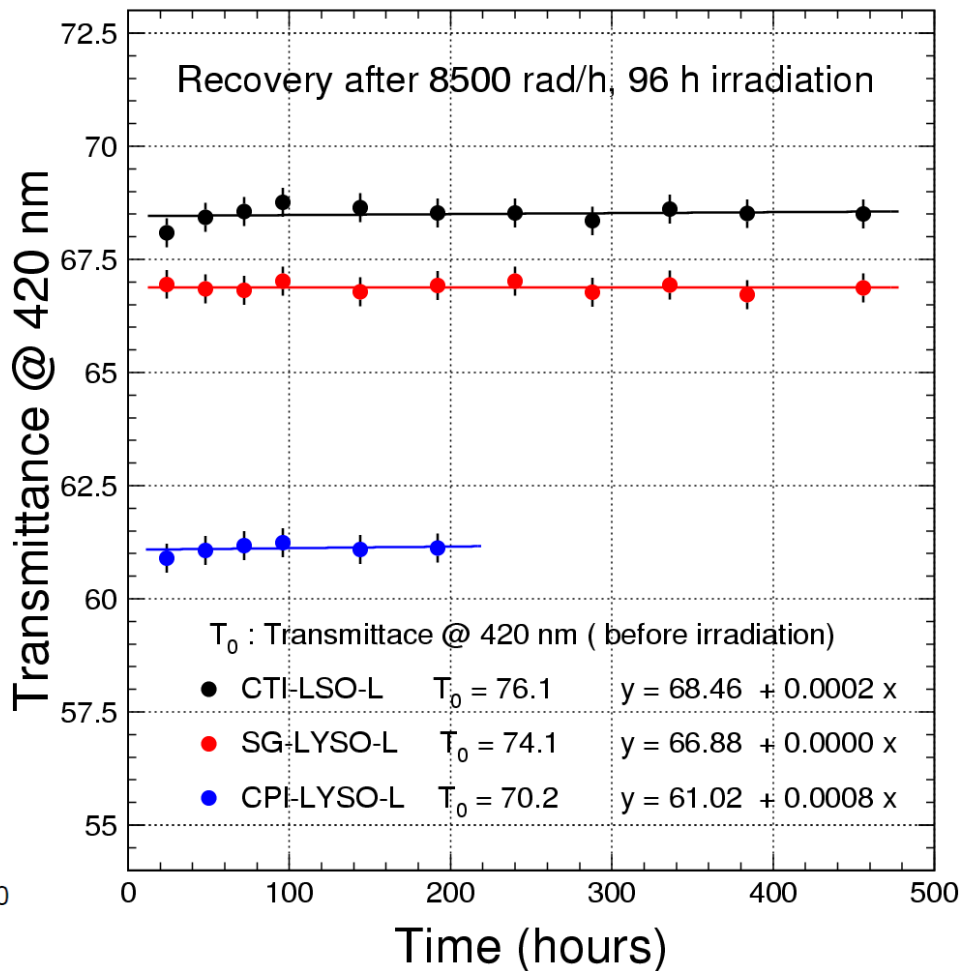
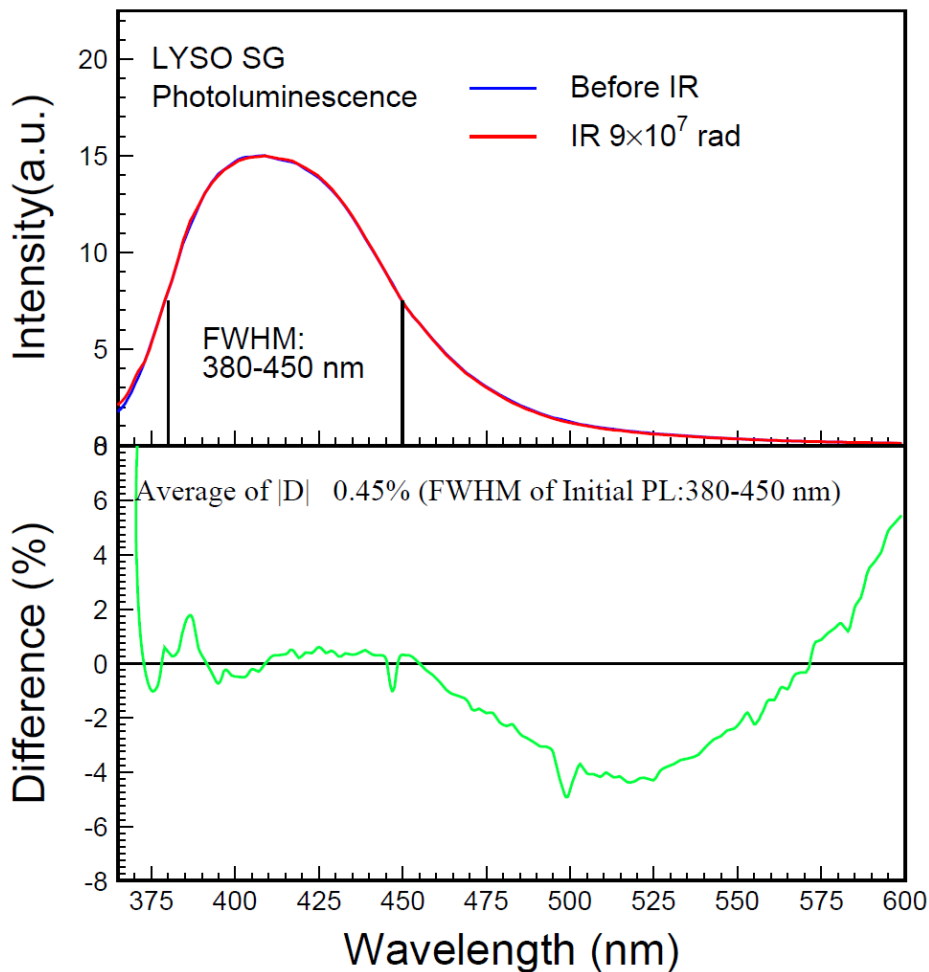



Radiation Hardness of 20 cm LYSO



About 20% loss and <5% divergence for six vendors after 10 Mrad

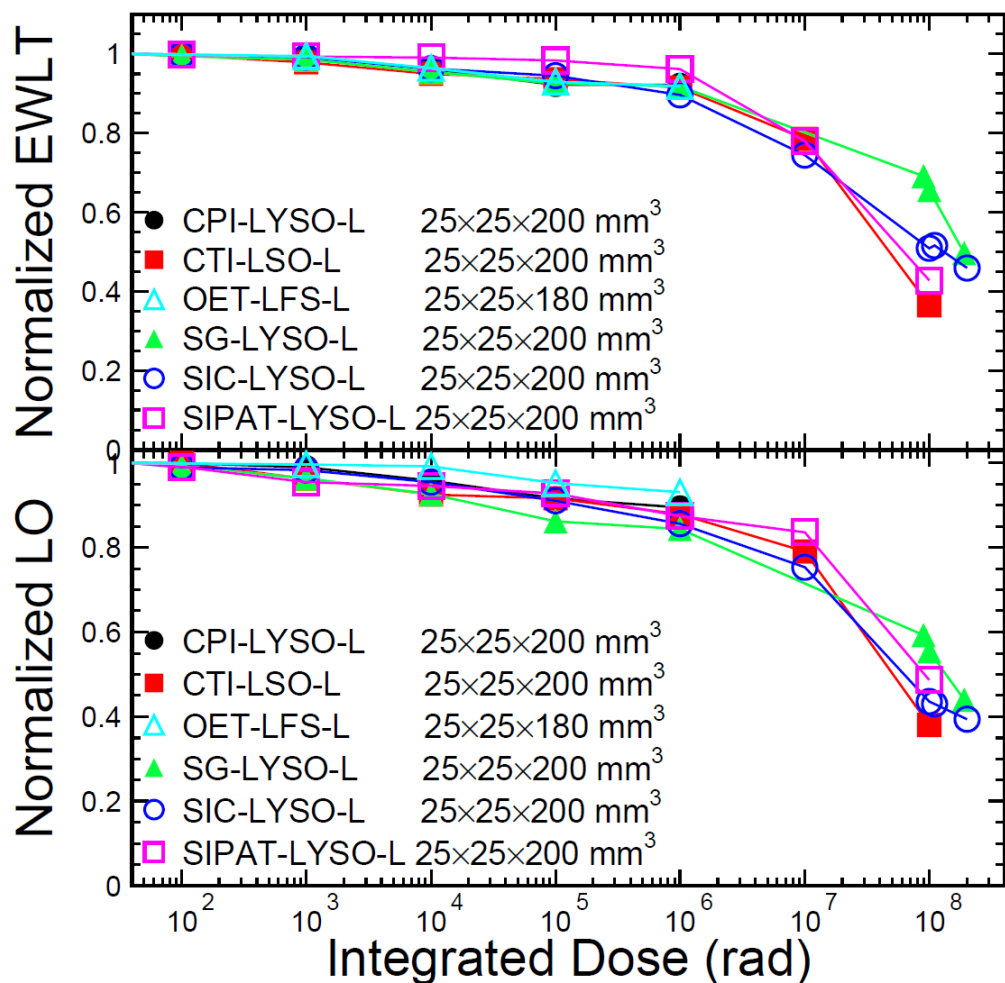
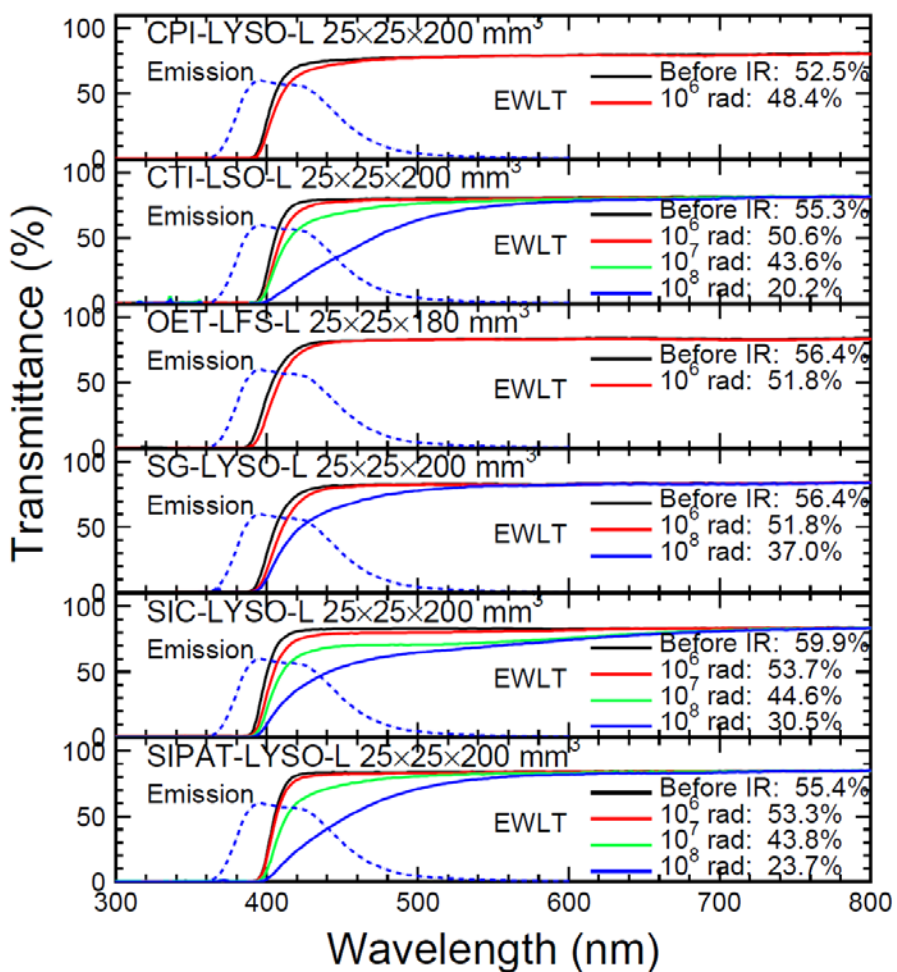



An Option for CMS FCAL Upgrade

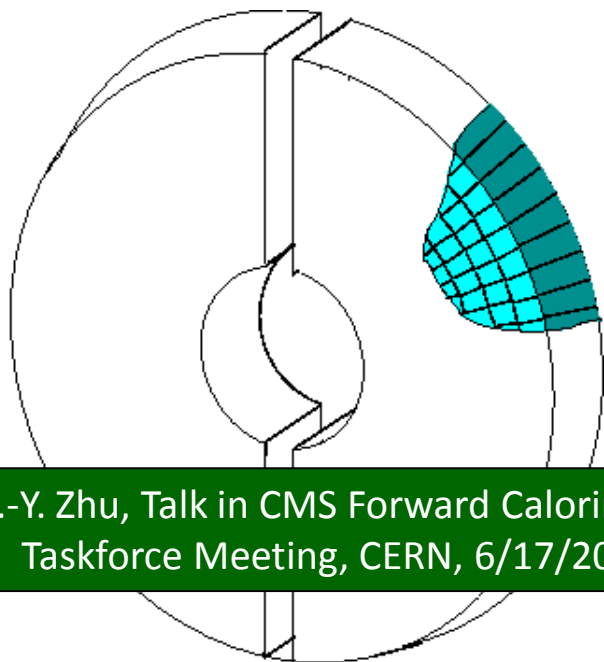
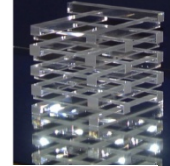

R.-Y. Zhu, Talk in CMS Forward Calorimeter Taskforce Meeting, CERN, 6/17/2010

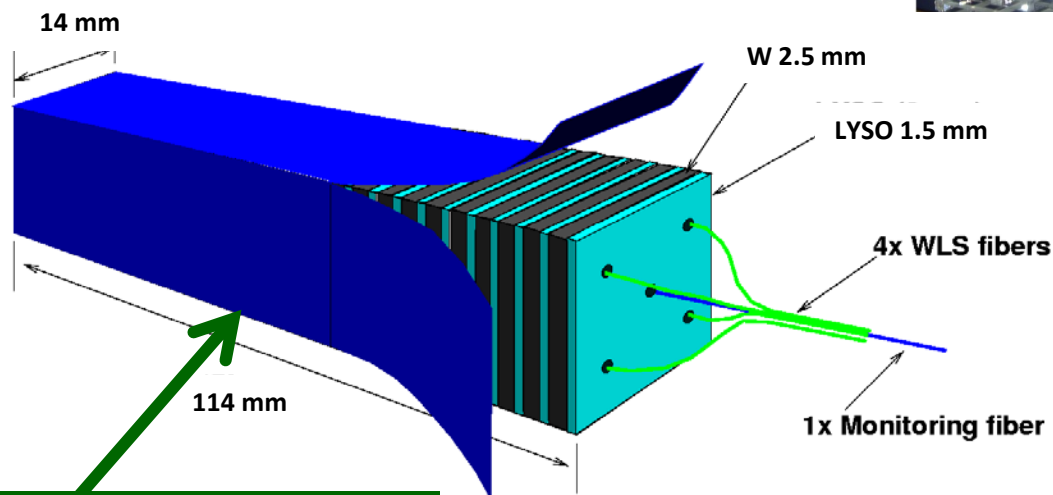

One of two options for CMS Upgrade

Issues: Radiation hardness of photo-detector and WLS fiber

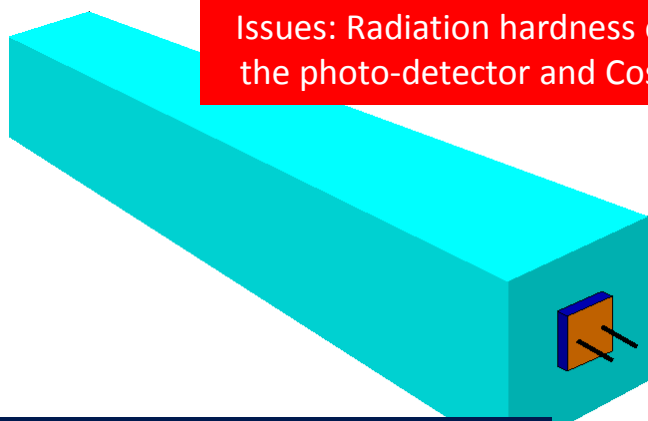

Issues: Radiation hardness of the photo-detector and Cost

CMS ECAL endcap: Single Crystal: 160 cm^3
Total number: 16,000 Total Volume: 3 m^3

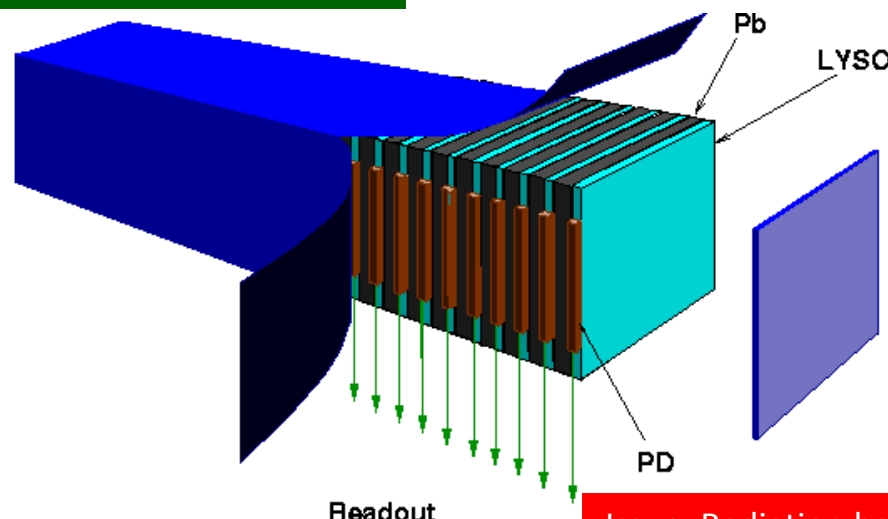

Reduced Crystal Cost & damage

Issue: Radiation hardness of the photo-detector



A Shashlik Cell Irradiated at JPL

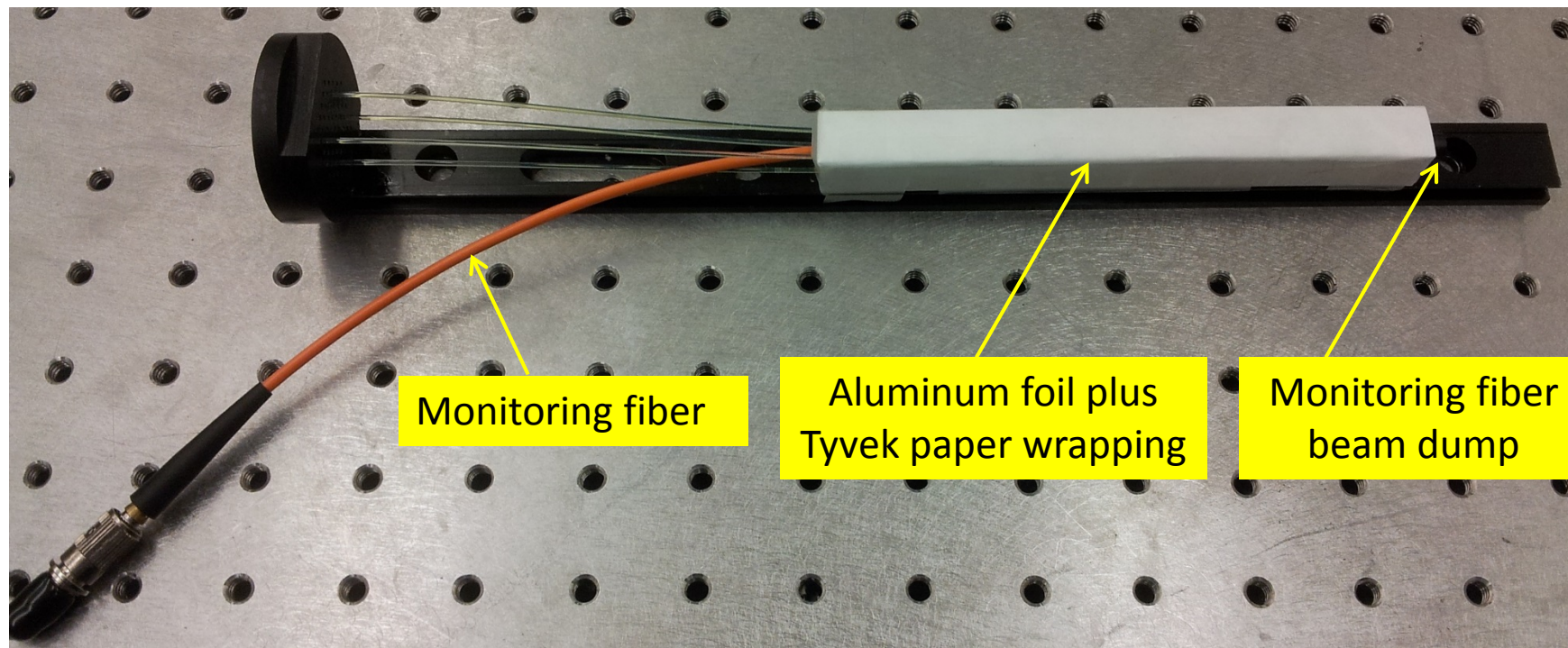
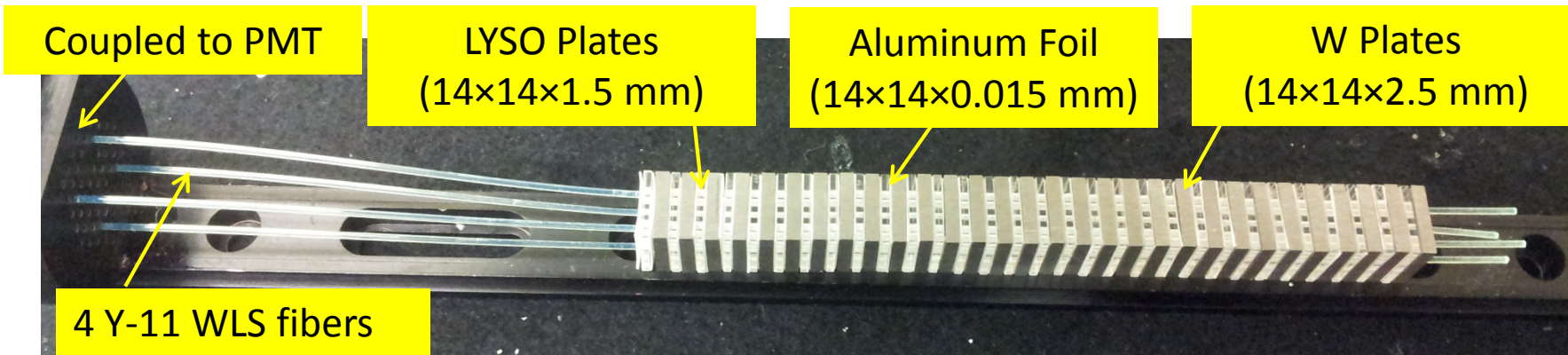



Summary of γ -ray Induced Damage

EWRIAC = 1.5, 3 and 4 m^{-1} after 10, 100 and 180 Mrad
LO loss after 100 Mrad is 4 and 6% respectively for direct and WLS readout

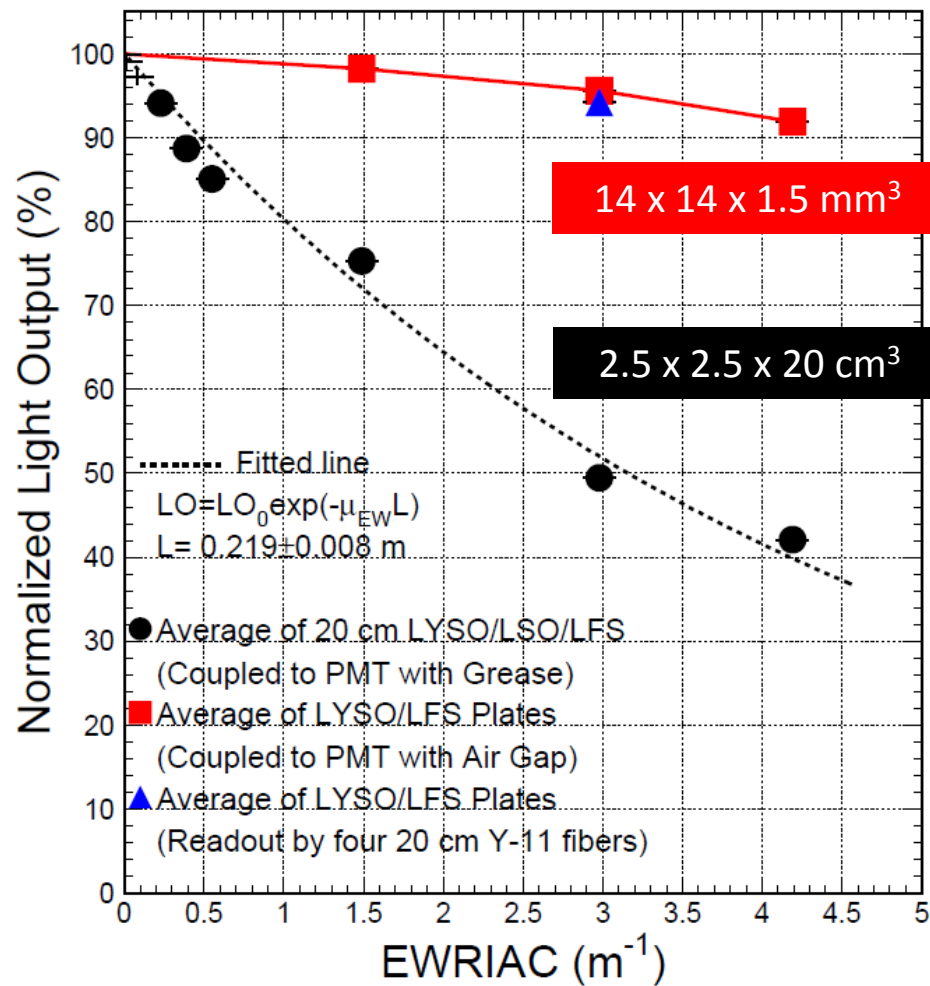
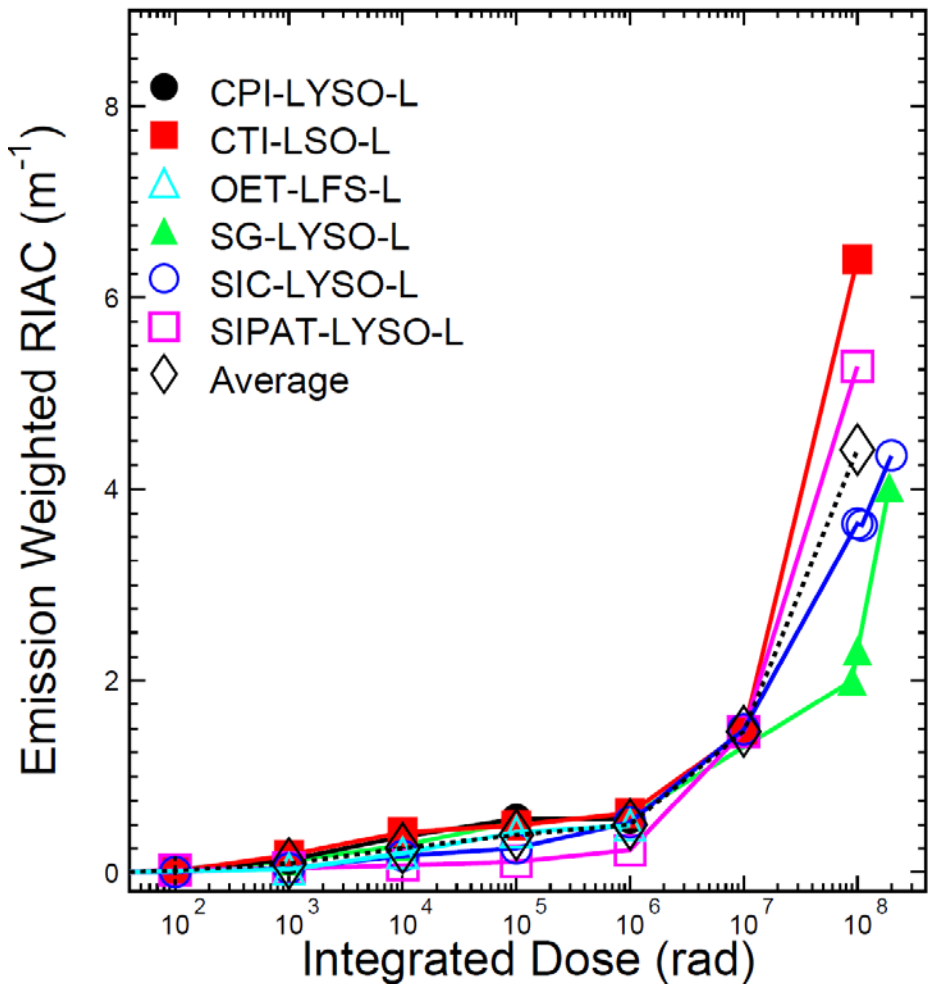



Summary of Proton Induced Damage



A 20 cm and four 14×14×1.5 mm³ LYSO were irradiated by 800 MeV and 24 GeV protons at LANL and CERN respectively. The result shows that the expected RIAC at the HL-LHC is about a few m⁻¹, indicating loss of 4 and 6% respectively for direct and WLS readout.

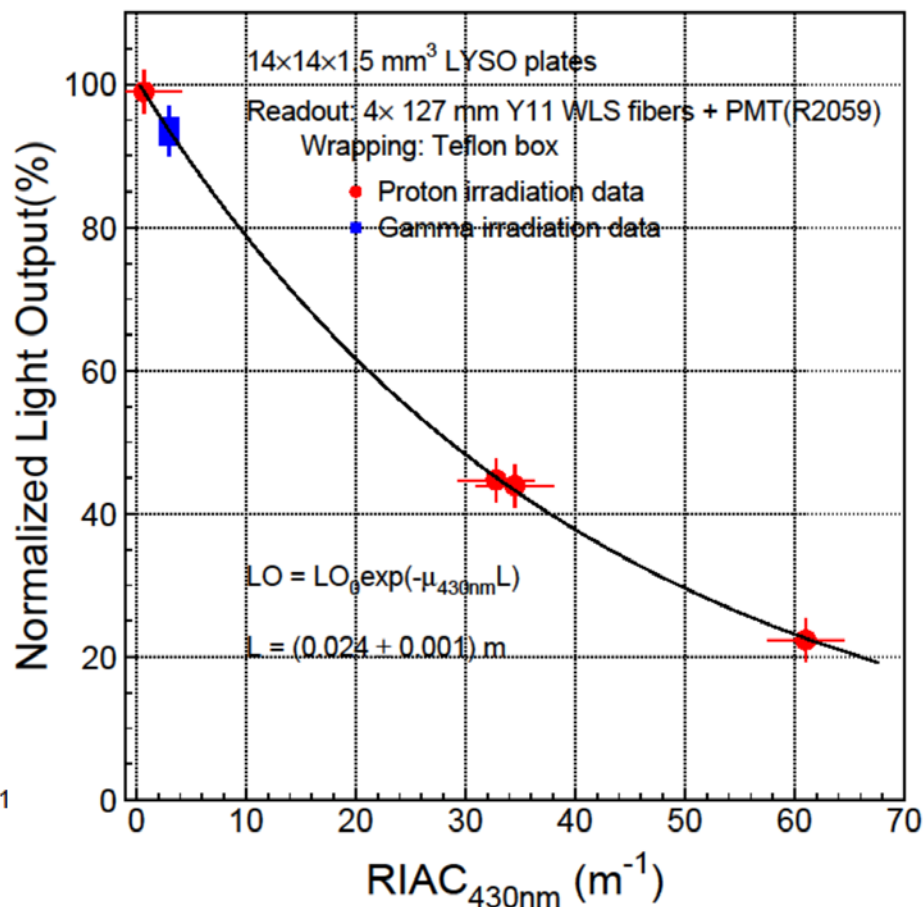
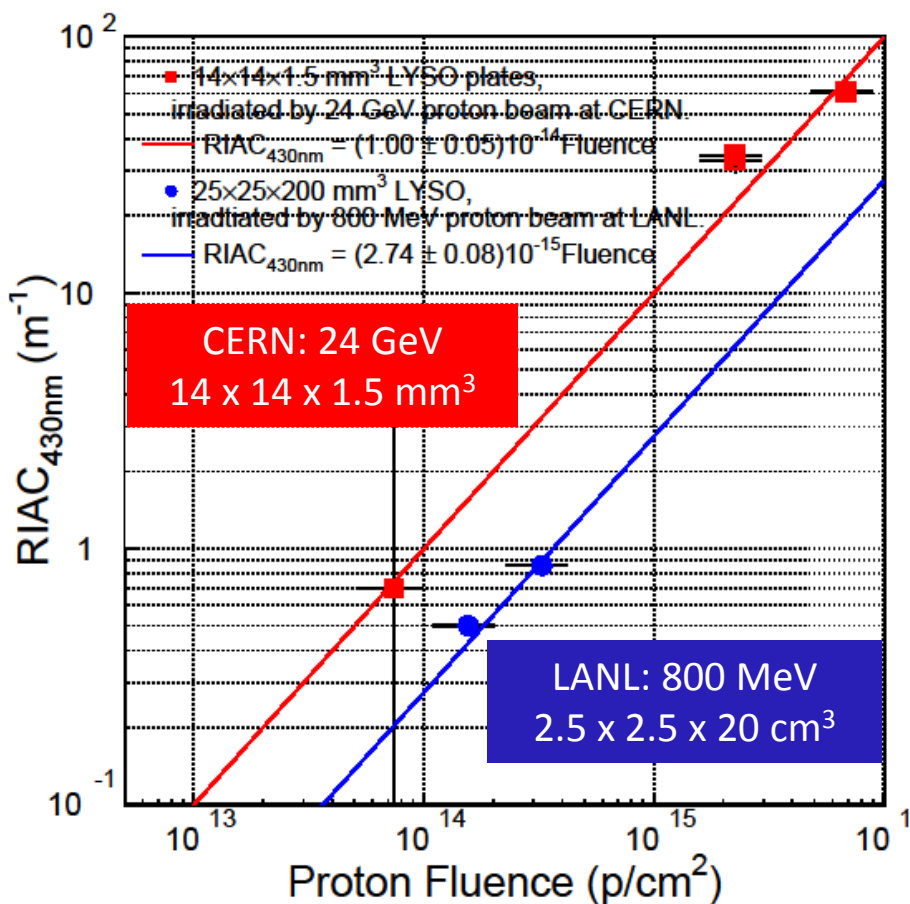



LSO/LYSO Crystal Cost



Crystal Cost Breakdown

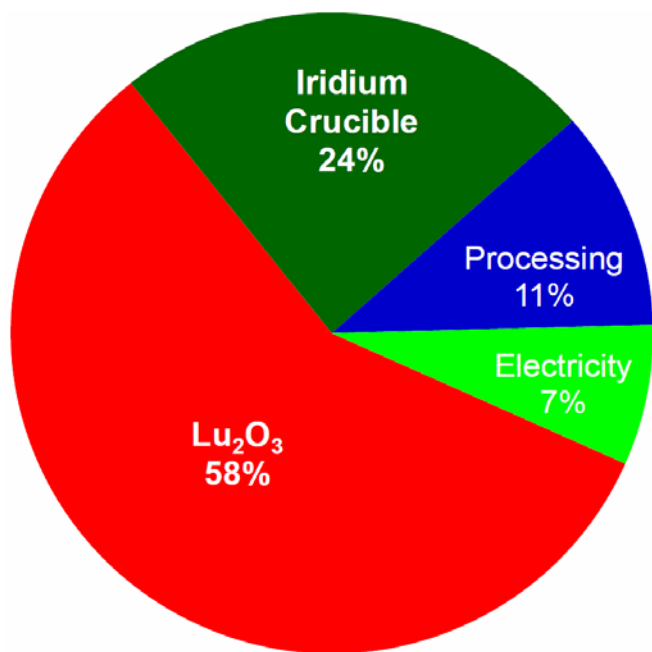

Rare earth export control in China

Rare earth strategic reserve in China

Rare earth market going to normal

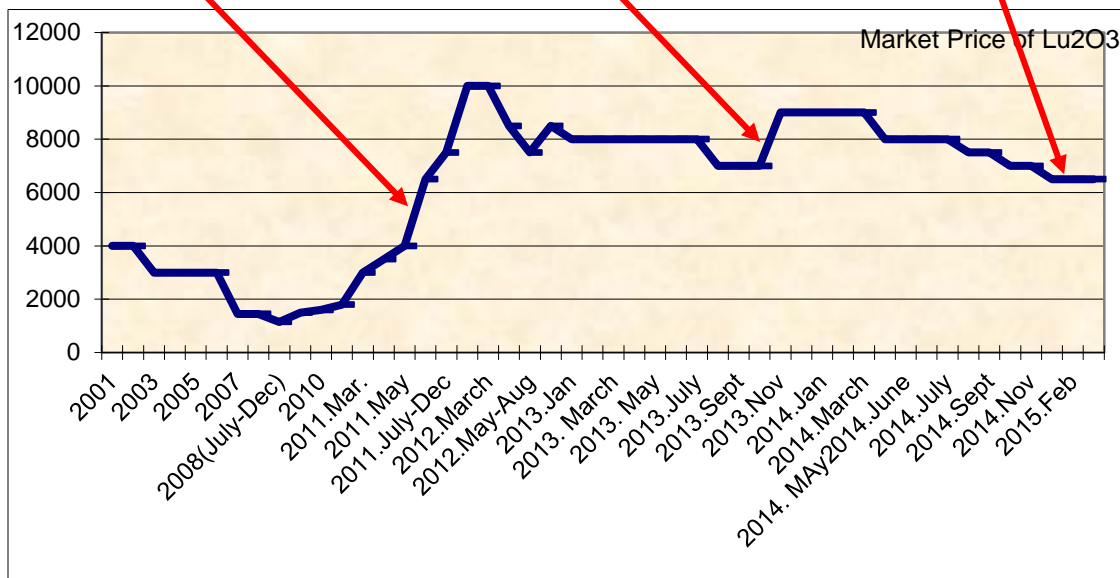

Assuming Lu₂O₃ at \$400/kg and 33% yield the cost is about \$18/cc. Quotations received at \$22-25/cc.

Current Lu₂O₃ price indicates that LYSO price is going down from \$42/cc last year



Alternative Fast Crystals



Talk in CMS Forward Calorimetry Task Force Meeting, CERN, June 27, 2012

	LSO/LYSO	GSO	YSO ¹	CsI	BaF ₂	CeF ₃	CeBr ₃ ²	LaCl ₃	LaBr ₃	Plastic scintillator (BC 404) ³
Density (g/cm ³)	7.40	6.71	4.44	4.51	4.89	6.16	5.23	3.86	5.29	1.03
Melting point (°C)	2050	1950	1980	621	1280	1460	722	858	783	70 [#]
Radiation Length (cm)	1.14	1.38	3.11	1.86	2.03	1.70	1.96	2.81	1.88	42.54
Molière Radius (cm)	2.07	2.23	2.93	3.57	3.10	2.41	2.97	3.71	2.85	9.59
Interaction Length (cm)	20.9	22.2	27.9	39.3	30.7	23.2	31.5	37.6	30.4	78.8
Z value	64.8	57.9	33.3	54.0	51.6	50.8	45.6	47.3	45.6	-
dE/dX (MeV/cm)	9.55	8.88	6.56	5.56	6.52	8.42	6.65	5.27	6.90	2.02
Emission Peak ^a (nm)	420	430	420	420 310	300 220	340 300	371	335	356	408
Refractive Index ^b	1.82	1.85	1.80	1.95	1.50	1.62	1.9	1.9	1.9	1.58
Relative Light Yield ^{a,c}	100	45	76	4.2 1.3	42 4.8	8.6	141	15 49	153	35
Decay Time ^a (ns)	40	73	60	30 6	650 0.9	30	17	570 24	20	1.8
d(LY)/dT ^d (%/°C)	-0.2	-0.4	-0.3	-1.4	-1.9 0.1	~0	-0.1	0.1	0.2	~0

- a. Top line: slow component, bottom line: fast component.
 - b. At the wavelength of the emission maximum.
 - c. Relative light yield normalized to the light yield of LSO
 - d. At room temperature (20°C)
 - #. Softening point
1. N. Tsuchida et al *Nucl. Instrum. Methods Phys. Res. A*, 385 (1997) 290-298
<http://www.hitachi-chem.co.jp/english/products/cc/017.html>
 2. W. Drozdowski et al. *IEEE TRANS. NUCL. SCI*, VOL.55, NO.3 (2008) 1391-1396
Chenliang Li et al, *Solid State Commun*, Volume 144, Issues 5–6 (2007),220–224
<http://scintillator.lbl.gov/>
 3. <http://www.detectors.saint-gobain.com/Plastic-Scintillator.aspx>
http://pdg.lbl.gov/2008/AtomicNuclearProperties/HTML_PAGES/216.html



Rising Time for $1.5 X_0$ Samples



Talk in the time resolution workshop at U. Chicago, 4/28/2011: Agilent MSO9254A (2.5 GHz) DSO with 0.14 ns rise time Hamamatsu R2059 PMT (2500 V) with rise time 1.3 ns

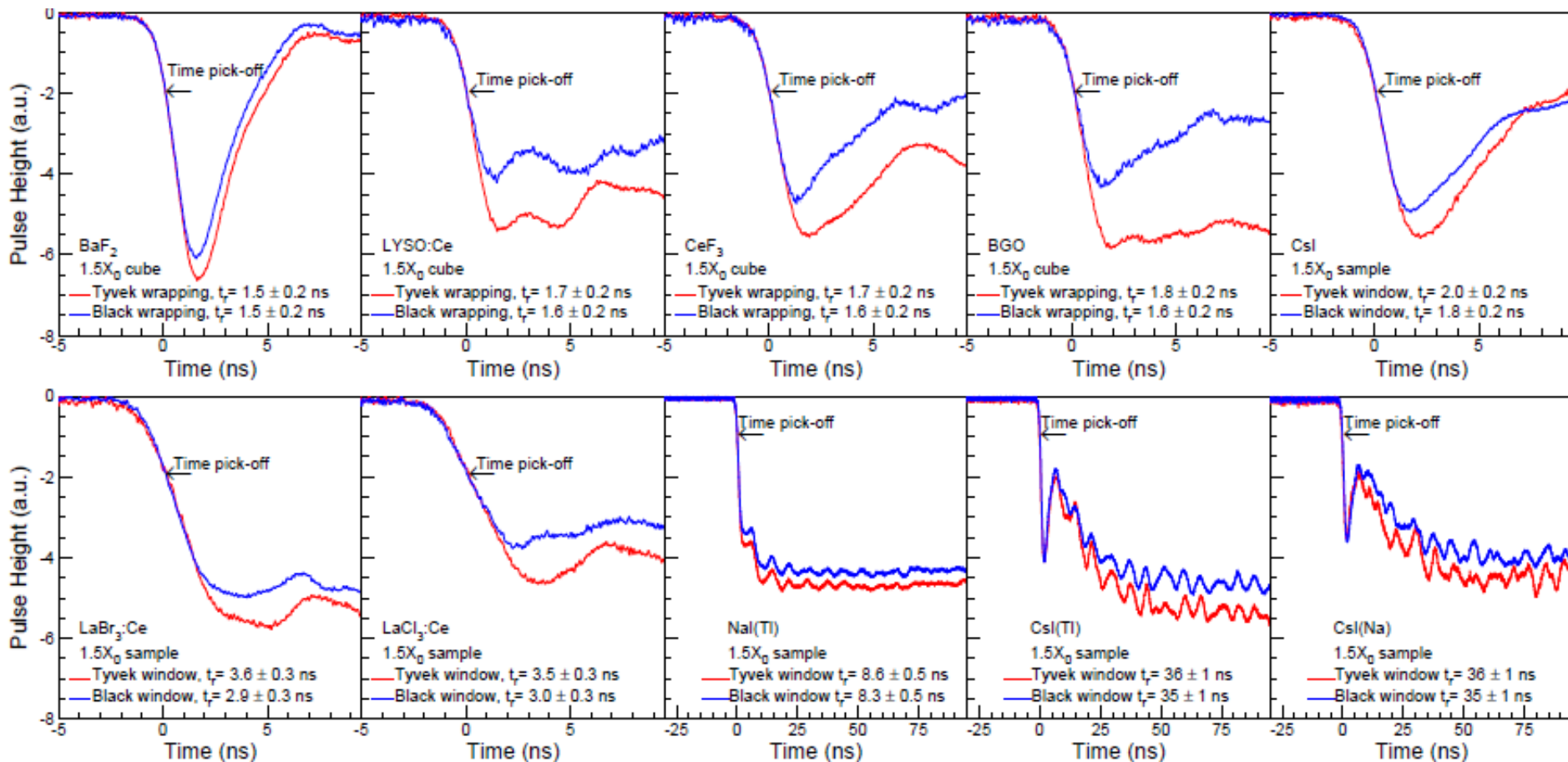

Measured rising time is dominated by photo-detector response, and is affected by light propagation in crystal.



Figure of Merit for Timing



FoM is calculated as the LY in 1st ns obtained by using light output and decay time data measured for 1.5 X₀ crystal samples.

Crystal Scintillators	Relative LY (%)	A ₁ (%)	τ ₁ (ns)	A ₂ (%)	τ ₂ (ns)	Total LO (p.e./MeV, XP2254B)	LO in 1ns (p.e./MeV, XP2254B)	LO in 0.1ns (p.e./MeV, XP2254B)	LY in 0.1ns (photons/MeV)
BaF ₂	40.1	91	650	9	0.9	1149	71.0	11.0	136.6
LSO:Ca,Ce	94	100	30			2400	78.7	8.0	110.9
LSO/LYSO:Ce	85	100	40			2180	53.8	5.4	75.3
CeF ₃	7.3	100	30			208	6.8	0.7	8.6
BGO	21	100	300			350	1.2	0.1	2.5
PWO	0.377	80	30	20	10	9.2	0.42	0.04	0.4
LaBr ₃ :Ce	130	100	20			3810	185.8	19.0	229.9
LaCl ₃ :Ce	55	24	570	76	24	1570	49.36	5.03	62.5
NaI:Tl	100	100	245			2604	10.6	1.1	14.5
CsI	4.7	77	30	23	6	131	7.9	0.8	10.6
CsI:Tl	165	100	1220			2093	1.7	0.2	4.8
CsI:Na	88	100	690			2274	3.3	0.3	4.5

The best crystal scintillator for ultra-fast timing is BaF₂ and LSO(Ce/Ca) and LYSO(Ce). LaBr₃ is a material with high potential.



Mu2e BaF₂ Calorimeter

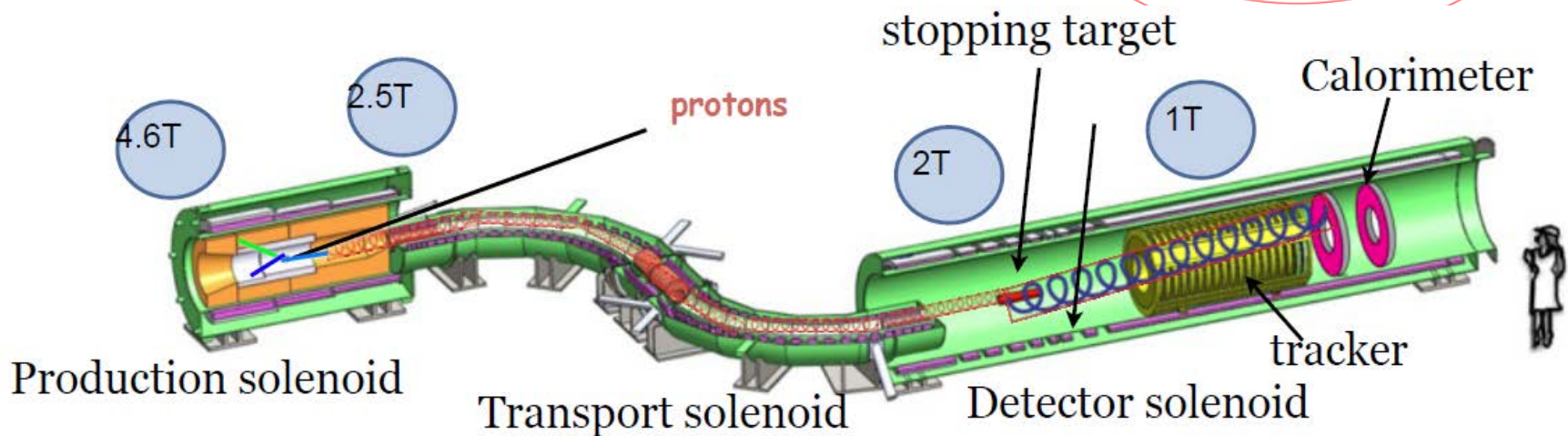
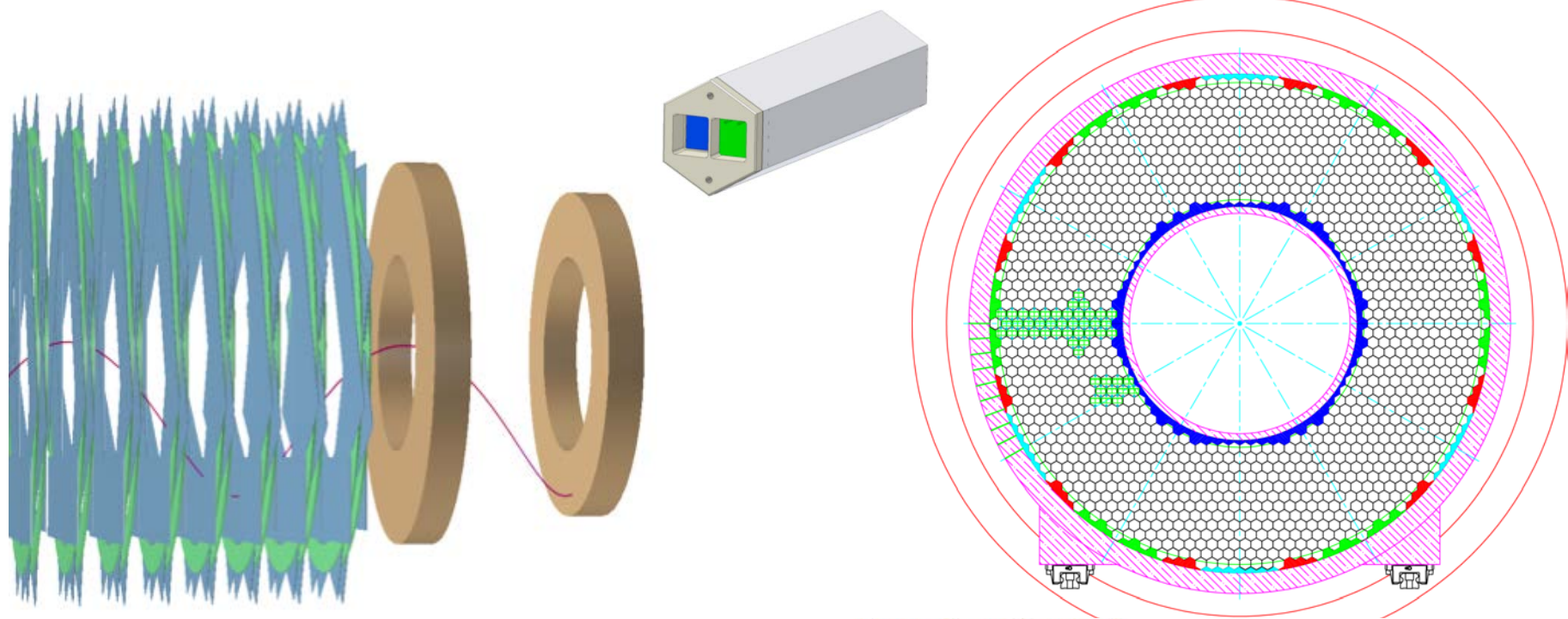



BaF₂ for Very Fast Calorimeter



The Light output of the fast component of BaF₂ crystals at 220 nm with sub-ns decay time is similar to pure CsI.

Spectroscopic selection of fast component may be achieved with solar blind photocathode and/or selective doping.

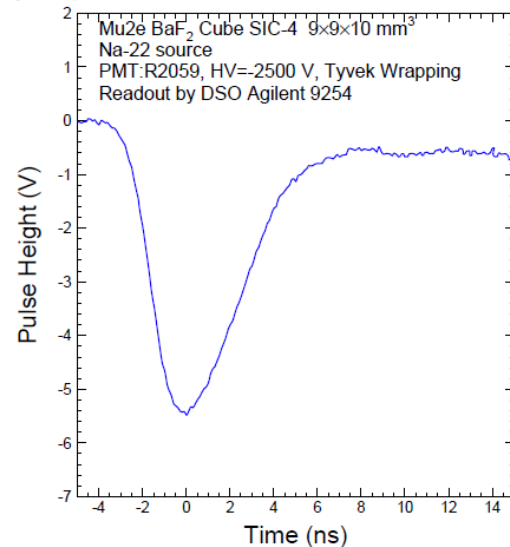
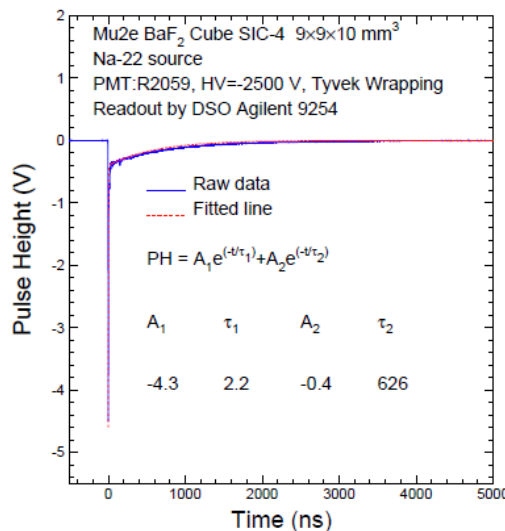
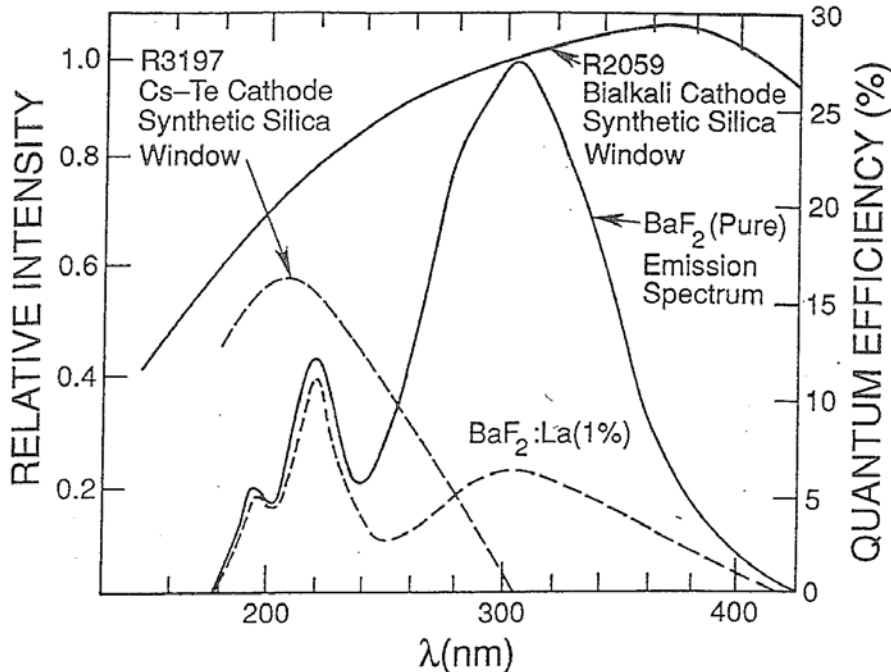

Slow Suppression by Doping and Readout



Y or La doping is effective in improving the F/S ratio for $Ba_{0.9}R_{0.1}F_2$ powders

B.P. SOBOLEV et al., "SUPPRESSION OF BaF2 SLOW COMPONENT OF X-RAY LUMINESCENCE IN NON-STOICHIOMETRIC $Ba_{0.9}R_{0.1}F_2$ CRYSTALS (R=RARE EARTH ELEMENT)," *Proceedings of The Material Research Society: Scintillator and Phosphor Materials*, pp. 277-283, 1994.

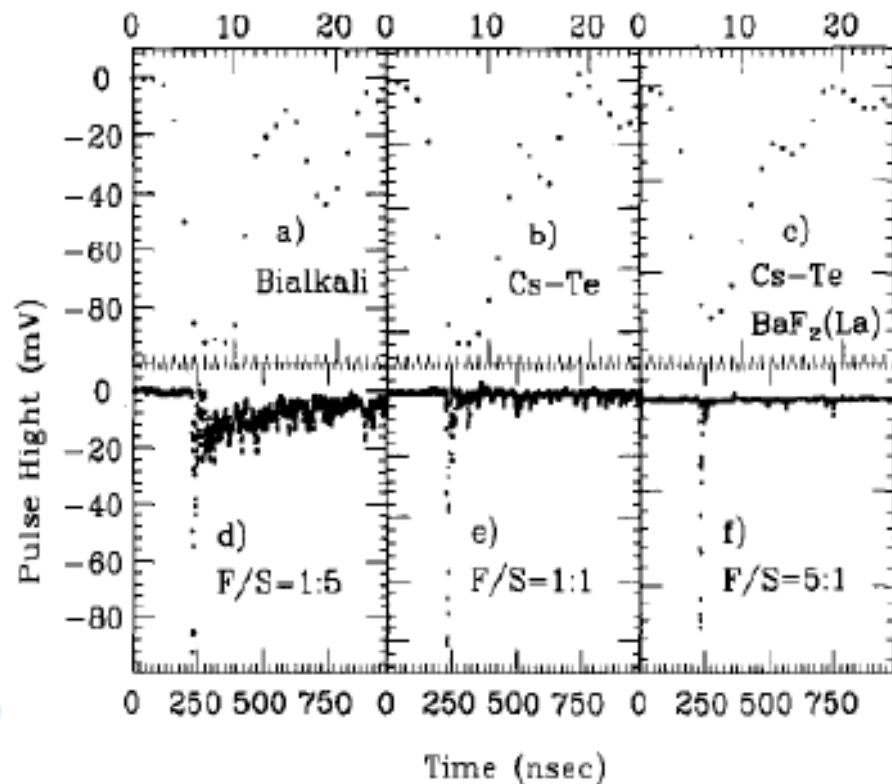
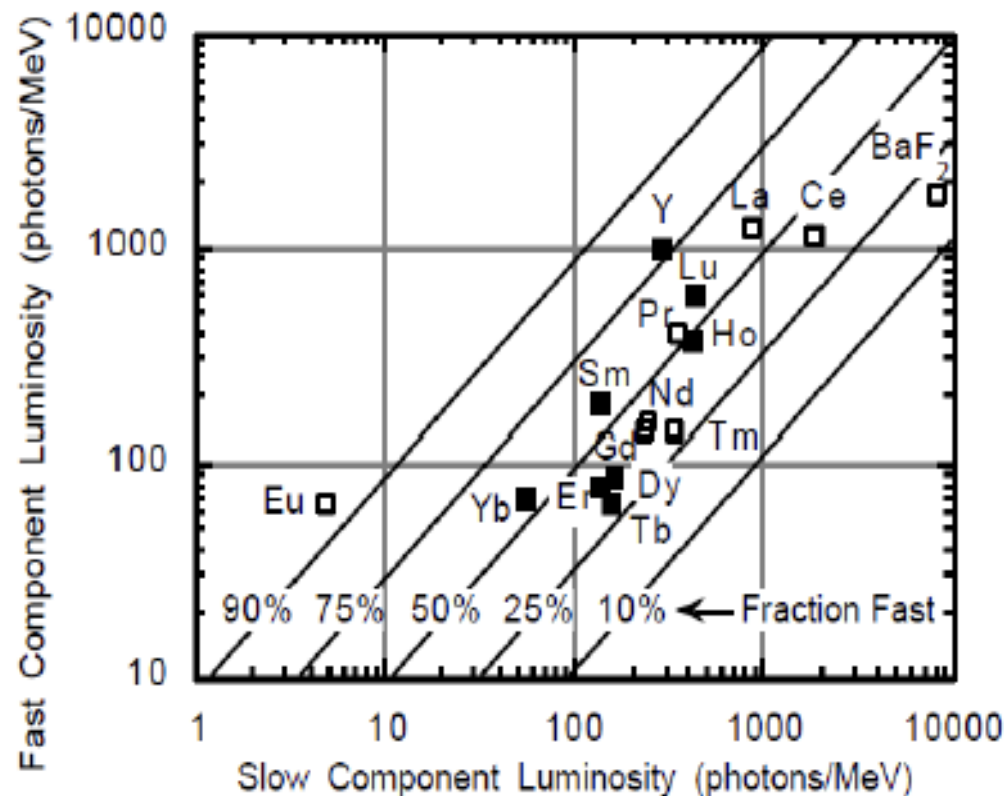

Solar blind cathode is also effective. R&D on doping will be carried out in 2015.

Z. Y. Wei, R. Y. Zhu, H. Newman, and Z. W. Yin, "Light Yield and Surface-Treatment of Barium Fluoride-Crystals," *Nucl Instrum Meth B*, vol. 61, pp. 61-66, Jul 1991.



Delta-doping for CCD detectors



D. Hitlin *et al*, in this meeting

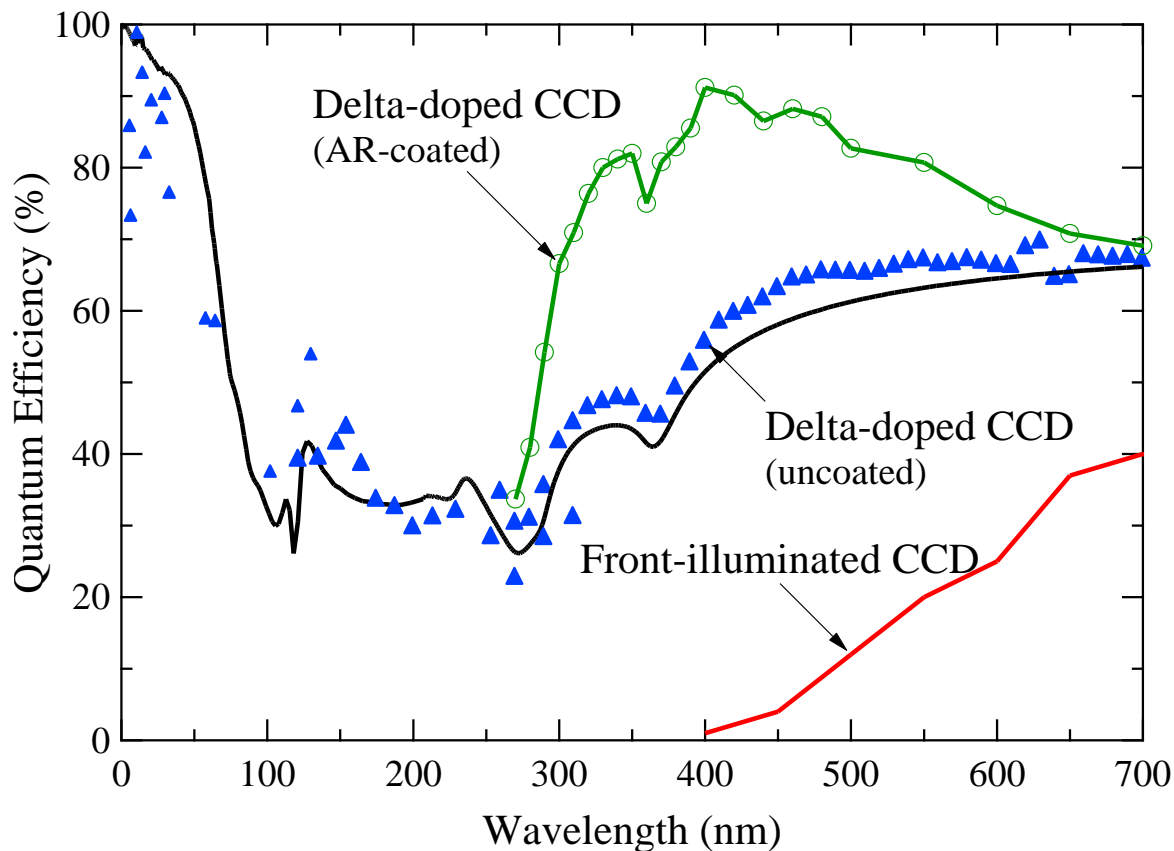
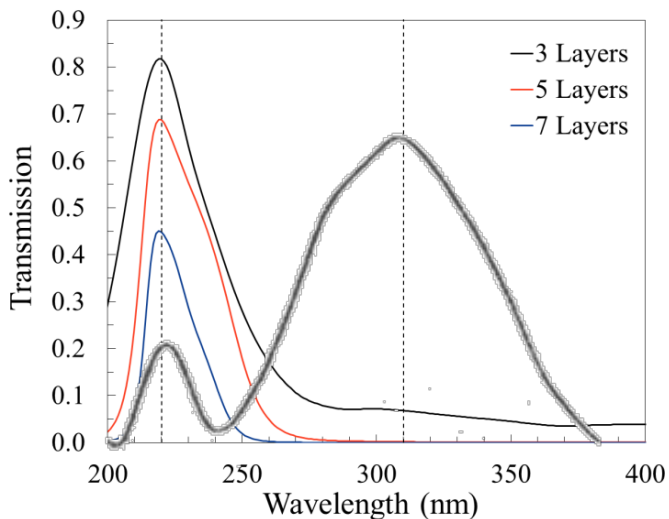
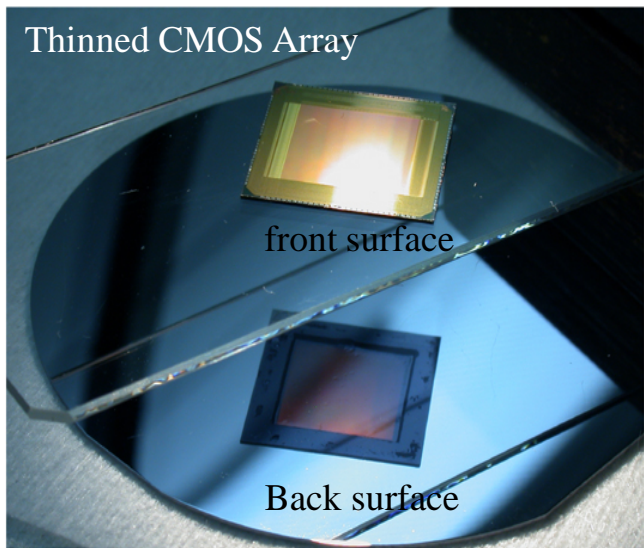

S. Nikzad, "Ultrastable and uniform EUV and UV detectors," *SPIE Proc.*, Vol. 4139, pp. 250-258 (2000).



Damage in Long BaF₂ Crystals



Radiation damage in BaF₂ crystals saturates at a few tens of krad

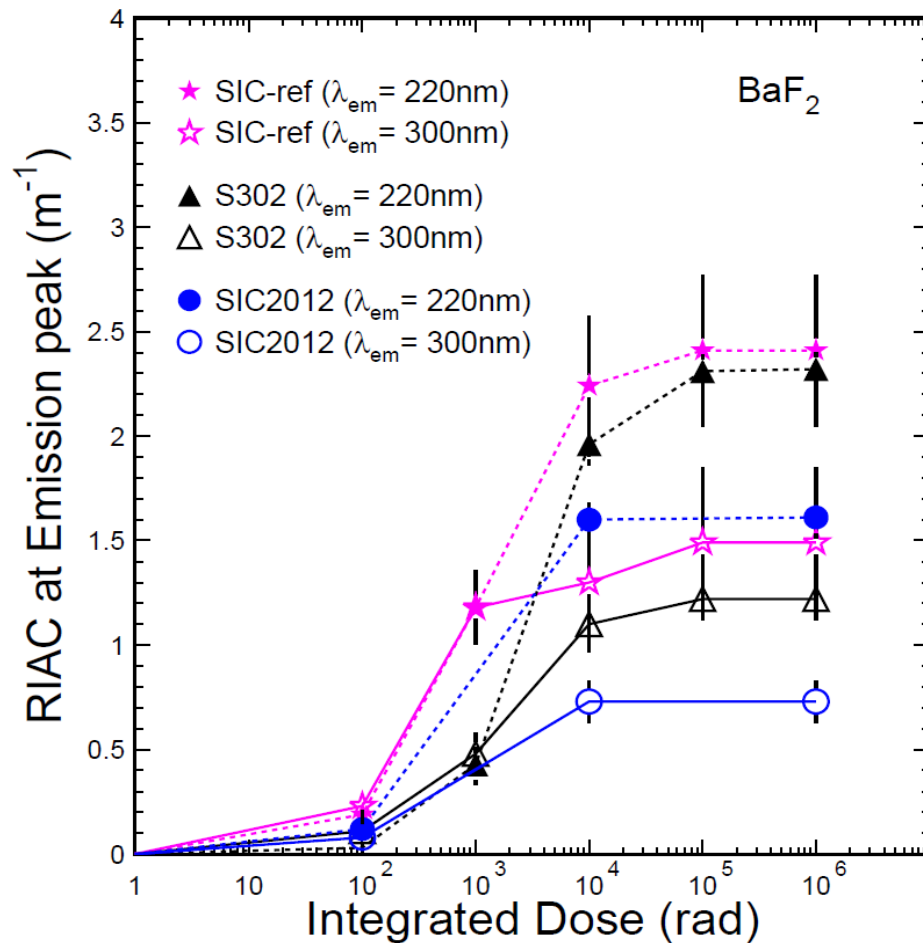
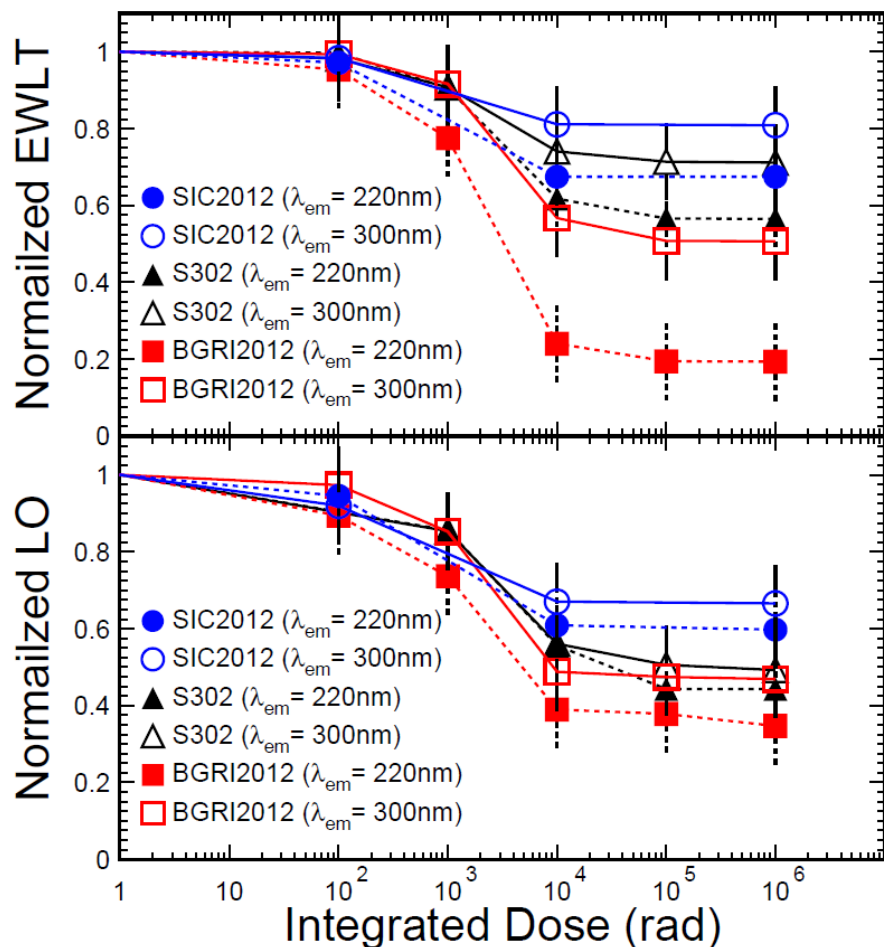

RIAC of mass produced BaF₂ may be controlled to less than 1.6 m⁻¹

Damage in Long Pure CsI Crystals



Consistent damage between 30/20 cm long pure CsI from SIC/Kharkov

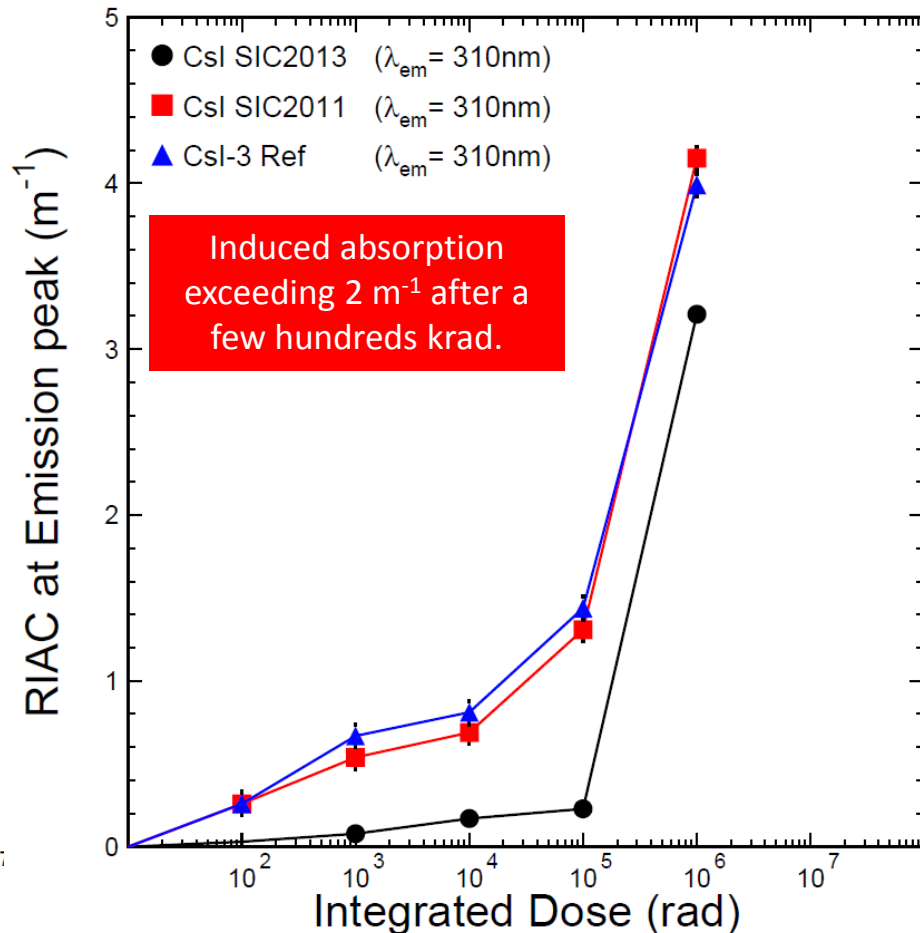
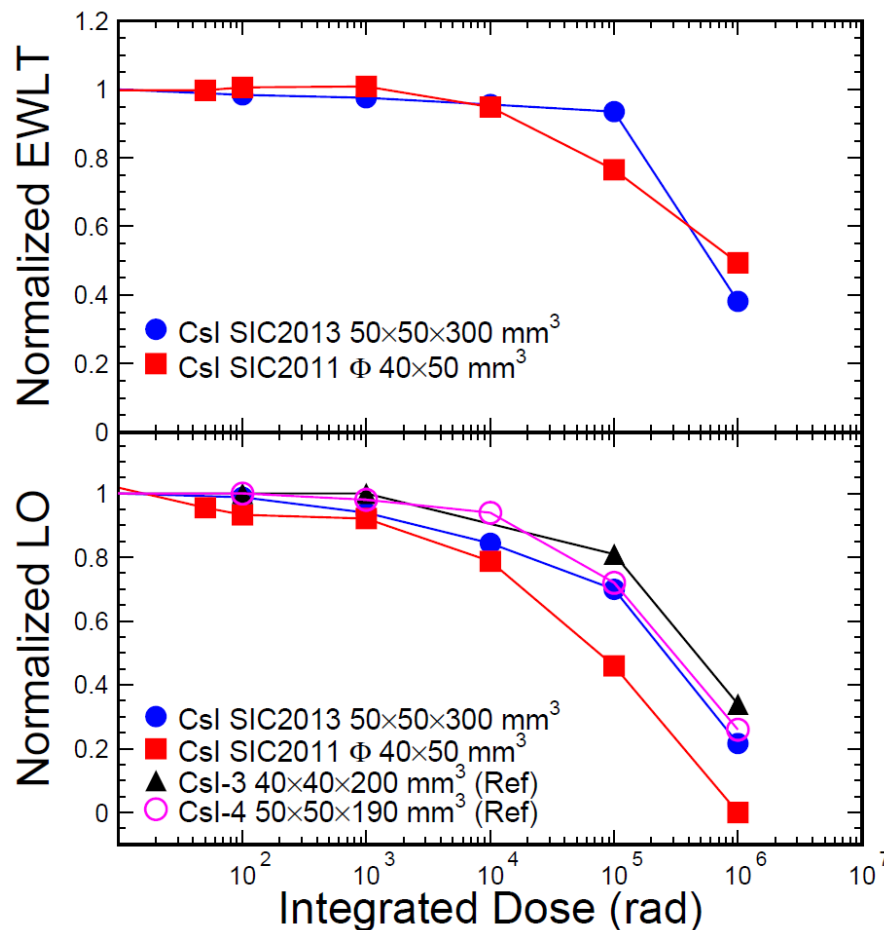

Data of Kharkov crystals: *Nucl. Ins. Meth. A* 326 (1993) 508-512



Homogeneous Hadronic Calorimeter



A Fermilab team (A. Para et al.) proposed a total absorption homogeneous hadronic calorimeter (HHCAL) detector concept to achieve good jet mass resolution by measuring both Cherenkov and Scintillation light.

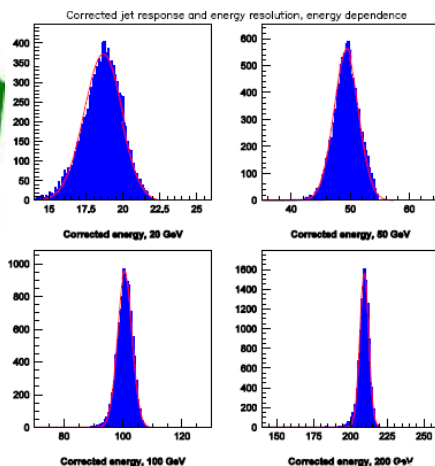
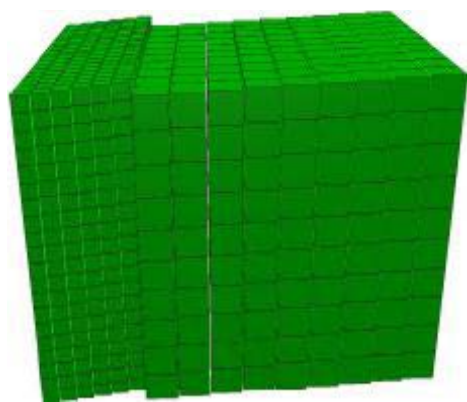

Requirements for the Materials:

- Cost-effective material: for 70~100 m³
- Short nuclear interaction length: ~ 20 cm.
- Good UV transmittance: UV cut-off < 350 nm, for readout of Cherenkov light.
- Some scintillation light, not necessary bright and fast.
- Discrimination between Cherenkov and scintillation lights, in spectral or temporal domain.

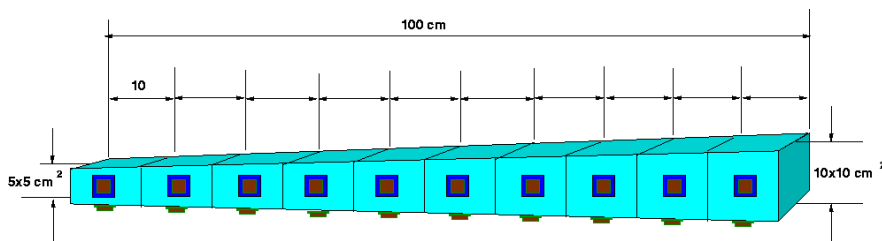

ILCWS-08, Chicago: a HHCAL cell with pointing geometry



Candidate Crystals for HHCAL



Cost-effective, UV transparent crystals with both scintillation and Cherenkov light

Parameters	$\text{Bi}_4\text{Ge}_3\text{O}_{12}$ (BGO)	PbWO_4 (PWO)	PbF_2	PbClF	$\text{Bi}_4\text{Si}_3\text{O}_{12}$ (BSO)
ρ (g/cm ³)	7.13	8.29	7.77	7.11	6.8
λ_l (cm)	22.8	20.7	21.0	24.3	23.1
n @ λ_{max}	2.15	2.20	1.82	2.15	2.06
τ_{decay} (ns)	300	30/10	?	30	100
λ_{max} (nm)	480	425/420	?	420	470
Cut-off λ (nm)	310	350	250	280	300
Light Output (%)	100	1.4/0.37	?	17	20
Melting point (°C)	1050	1123	842	608	1030
Raw Material Cost (%)	100	49	29	29	47

IEEE Trans. Nucl. Sci. **59** (2012) 2229-2236

Search for Scintillation in Doped PbF₂

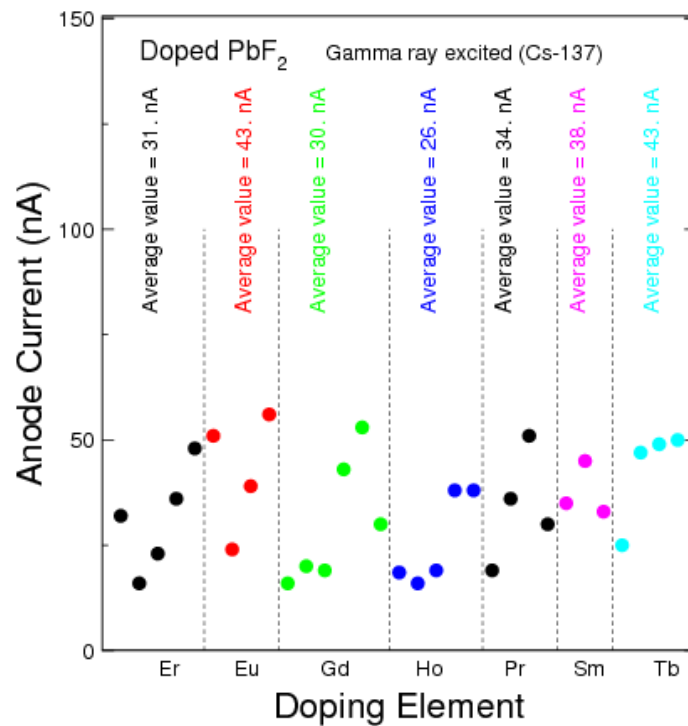
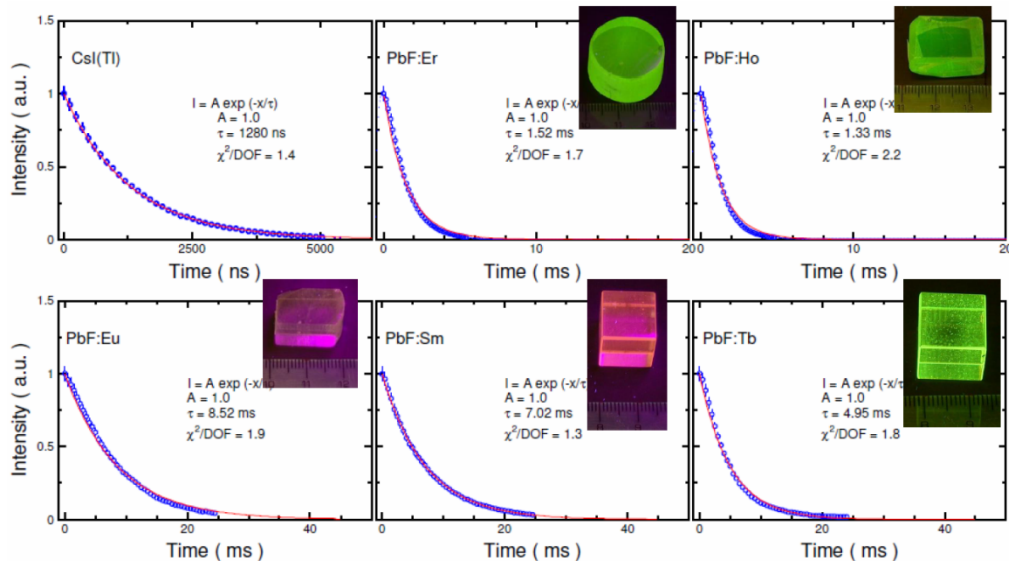
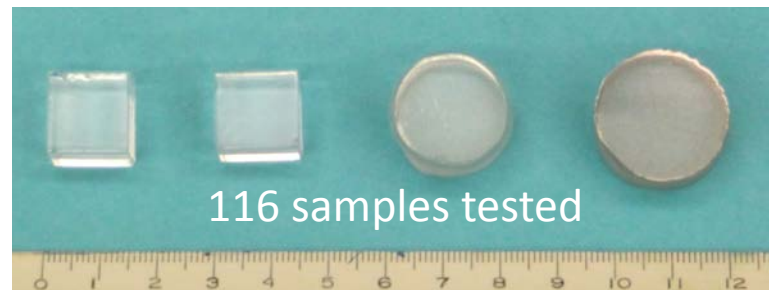
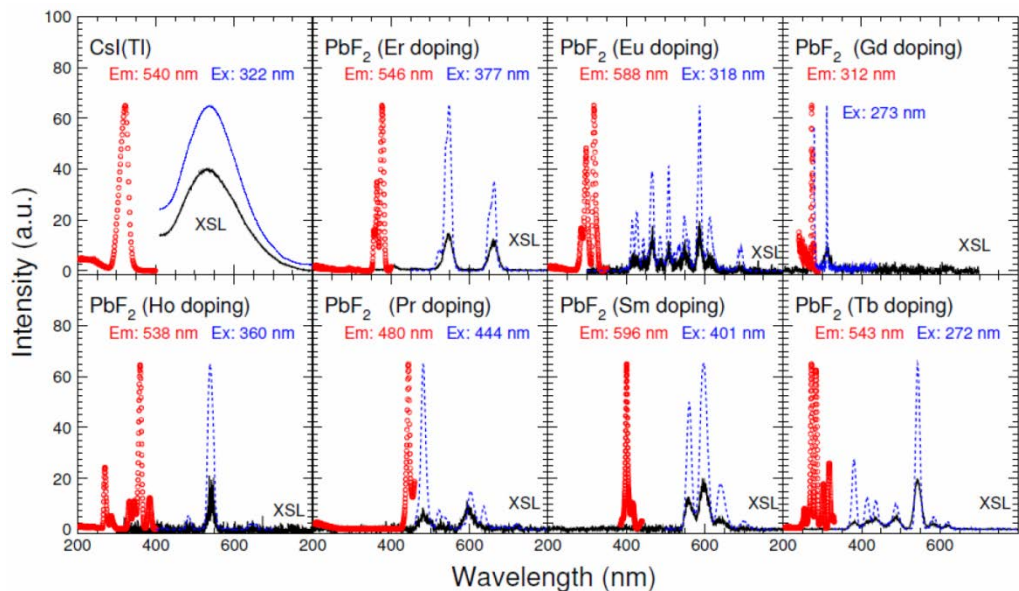

Will look performance at low temperature with the FLS920 fluorescence lifetime spectrometer



Other Materials: PbFCI & BSO

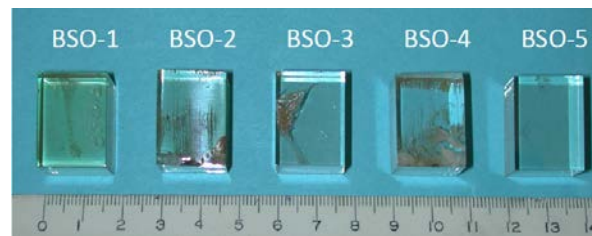

ID	PbFCI-1	PbFCI-2	PbFCI-3	PbFCI-4	PbFCI-5
Doping	--	Na 0.5at%	--	--	--
Dimension (mm)	10x10x2	10x10x2	30x10x5	20x10x3	~10x10x9

ID	PWO	PbFCI-1	PbFCI-2	PbFCI-3	PbFCI-4	PbFCI-5
X-luminescence				Peaked @ 420 nm		
L.O. (% PWO)	100	14	64	33	35	31
L.O. (% BGO)	1.8	0.25	1.1	0.59	0.63	0.56

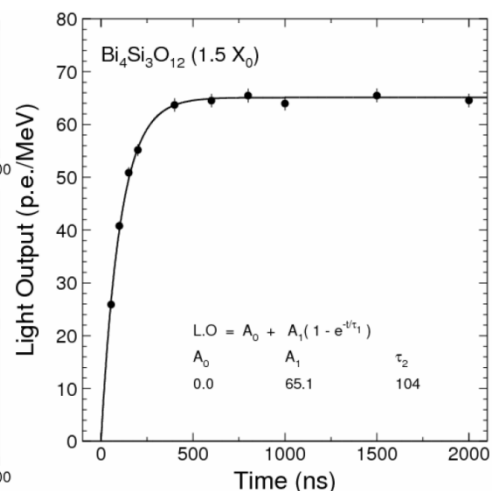
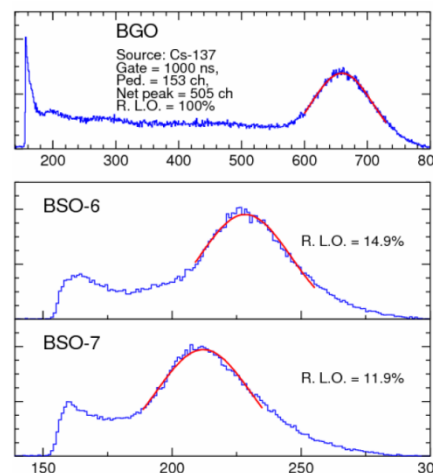
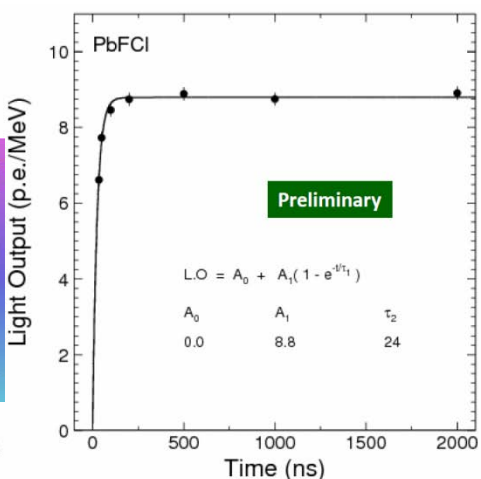
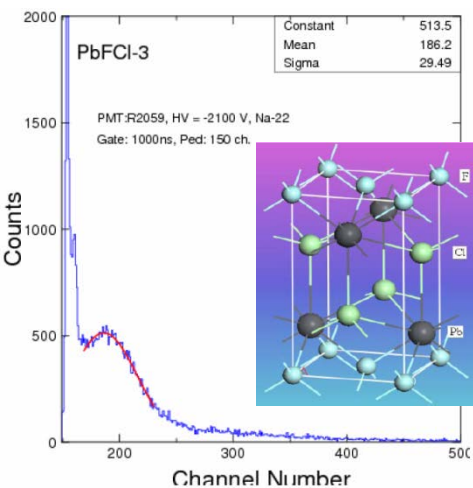
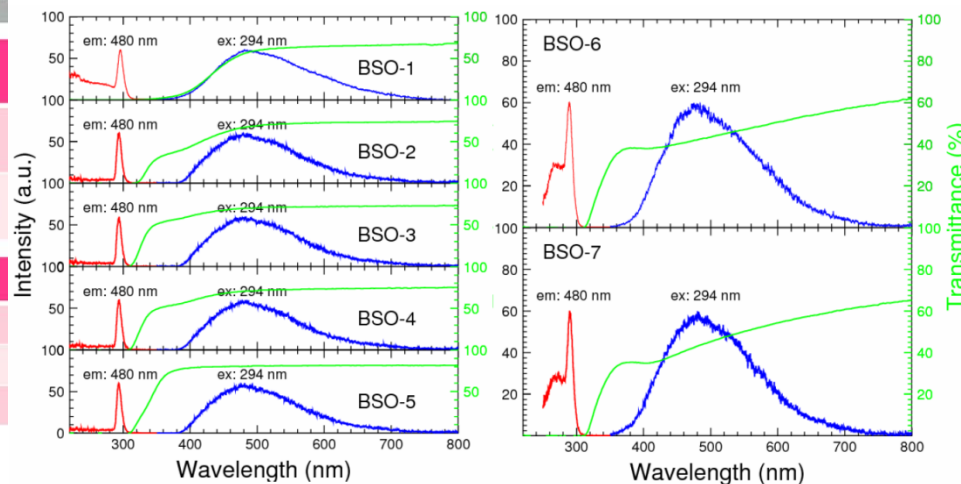



Large Size BSO Sample



20 x 20 x 200 mm BSO crystals shows good optical and scintillation properties.
Presented in SORMA2014.

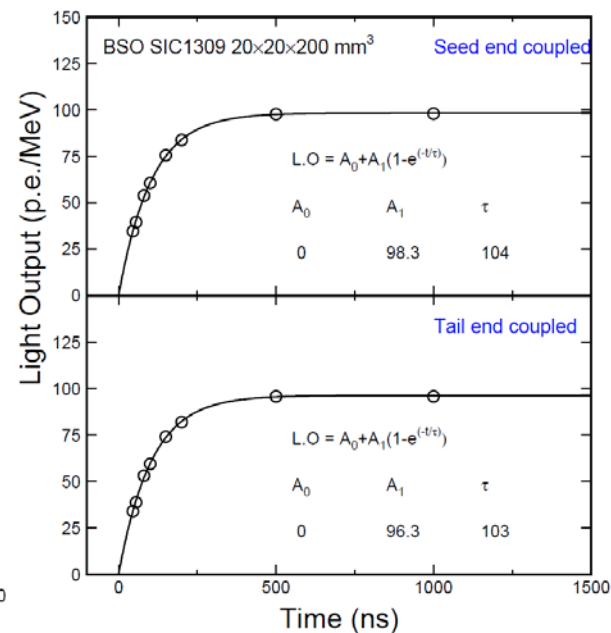
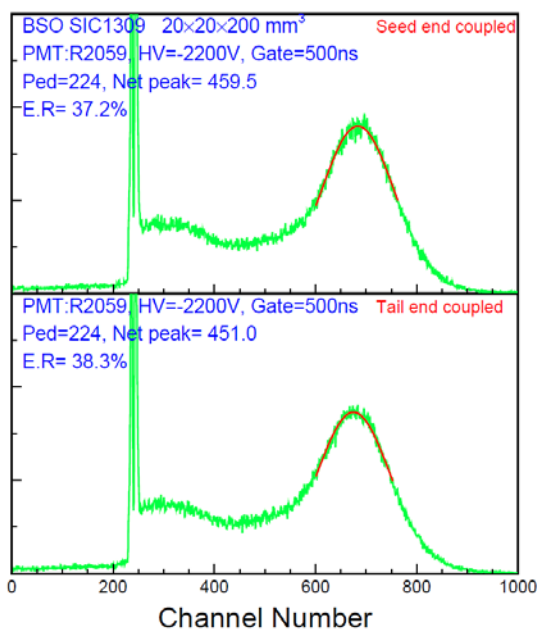
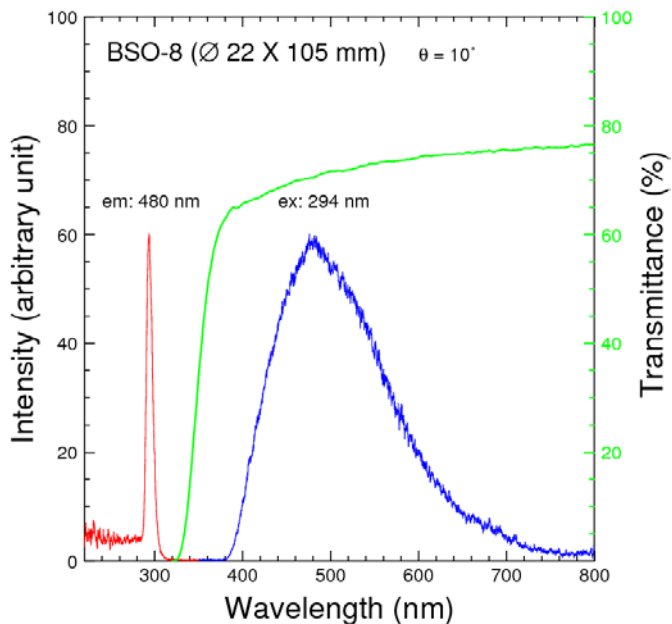



Summary



- **Bright, fast and radiation hard LSO/LYSO crystals are base-lined for a total absorption ECAL for COMET at J-PARC. LYSO crystal based sampling calorimeter offers a robust stable calorimeter for the proposed HL-LHC.**
- **Future crystal calorimeters with more than ten times faster rate/timing capability require very fast crystals, e.g. BaF₂ with a sub-ns scintillation component.**
- **Cost effective crystals (PbF₂, PbFCl & BSO) may provide a foundation for a homogeneous hadron calorimeter with dual readout for both Cherenkov and scintillation light to achieve good jet mass resolution for ILC/CLIC.**
- **Novel scintillators in crystals, ceramics and glasses, may play important role for future HEP experiments.**



LYSO Based Shashlik Cell Design



		LHCb	Plan-1	Plan-2
Absorber		Lead (Pb)	Lead (Pb)	Tungsten (W)
	Density (g/cm ³)	11.4	11.4	19.3
	Radiation Length (cm)	0.56	0.56	0.35
	Moliere Radius (cm)	1.60	1.60	0.93
	dE/dX (MeV/cm)	12.74	12.74	22.1
	Thickness (mm)	2	4	2.5
	Plates number	66	28	28
Scintillator		BASF-165 Polystyrene (Sc)	LYSO	LYSO
	Density (g/cm ³)	1.06	7.4	7.4
	Light Yield (photons/MeV)	5200	30000	30000
	Radiation length (cm)	41.31	1.14	1.14
	Moliere Radius (cm)	9.59	2.07	2.07
	dE/dX (MeV/cm)	2.05	9.55	9.55
	Plate Thickness(mm)	4	2	2
Plates number	67	29	29	
WLS Fiber		Kurarray Y-11(250)	Kurarray Y-11(250)	Kurarray Y-11(250)
	Diameter (mm)	1.2	1.2	1.2
	Number /Cell	16	4	4
Cell Properties	Total Depth (X0)	24.22	25.09	25.09
	Sampling Fraction (MIPs)	0.25	0.28	0.26
	Total Physical Length (cm)	40	17	12.8
	Total Sc Length (cm)	26.8	5.8	5.8
	Absorber Weight Ratio	0.84	0.75	0.76
	Scintillator Weight Ratio	0.16	0.25	0.24
	Average Density (g/cm ³)	4.47	10.04	13.91
	Average Radiation Length (cm)	1.65	0.68	0.51
	Average Moliere Radius (cm)	3.6	1.7	1.2
	Transverse Dimension (cm)	4.1	1.9	1.4
	Sc-depth/Total-depth in X0	0.0268	0.2028	0.2028
WLS Fiber Density (N/cm ²)	0.97	1.06	2.07	
MIPs Energy Deposition	Sc plates (MeV)	54.94	55.39	55.39
Light Yield using MIPs	Photon Electrons/GeV	3077	17897	17897
Signal of MIPs	Photon Electrons / MIP	169	991	991
Module Properties	Energy Resolution (a, %)	8.2	9.0*	9.0*

* Based on the simulation of Zhigang Wang, IHEP, Beijing.