

**Recent Results from
the Alpha Magnetic Spectrometer (AMS) Experiment
on the International Space Station**

R. Battiston

**University and INFN-TIFPA,
Trento**

IHEP-INFN Meeting, LNGS, September 17th 2013

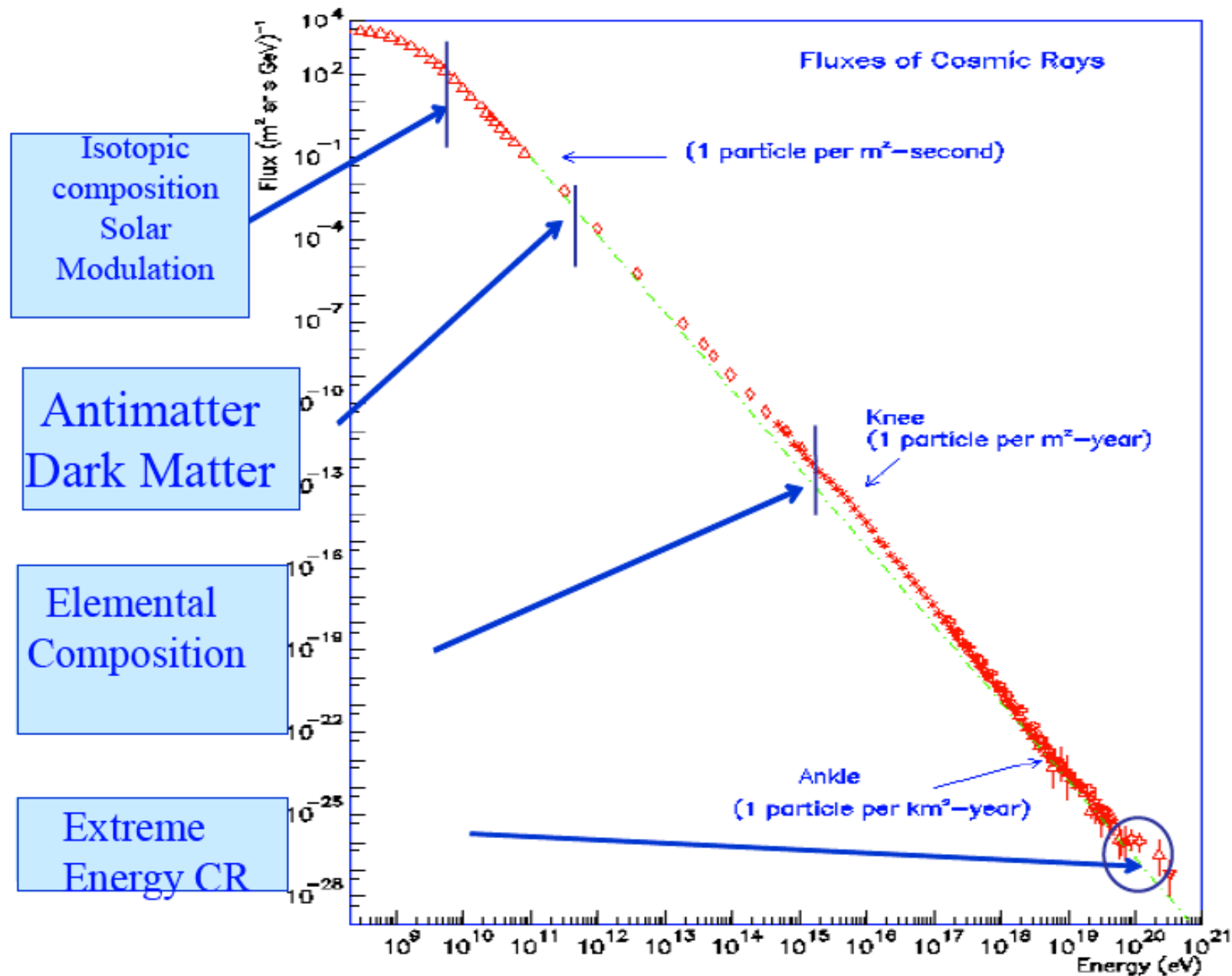

Experimental Challenges

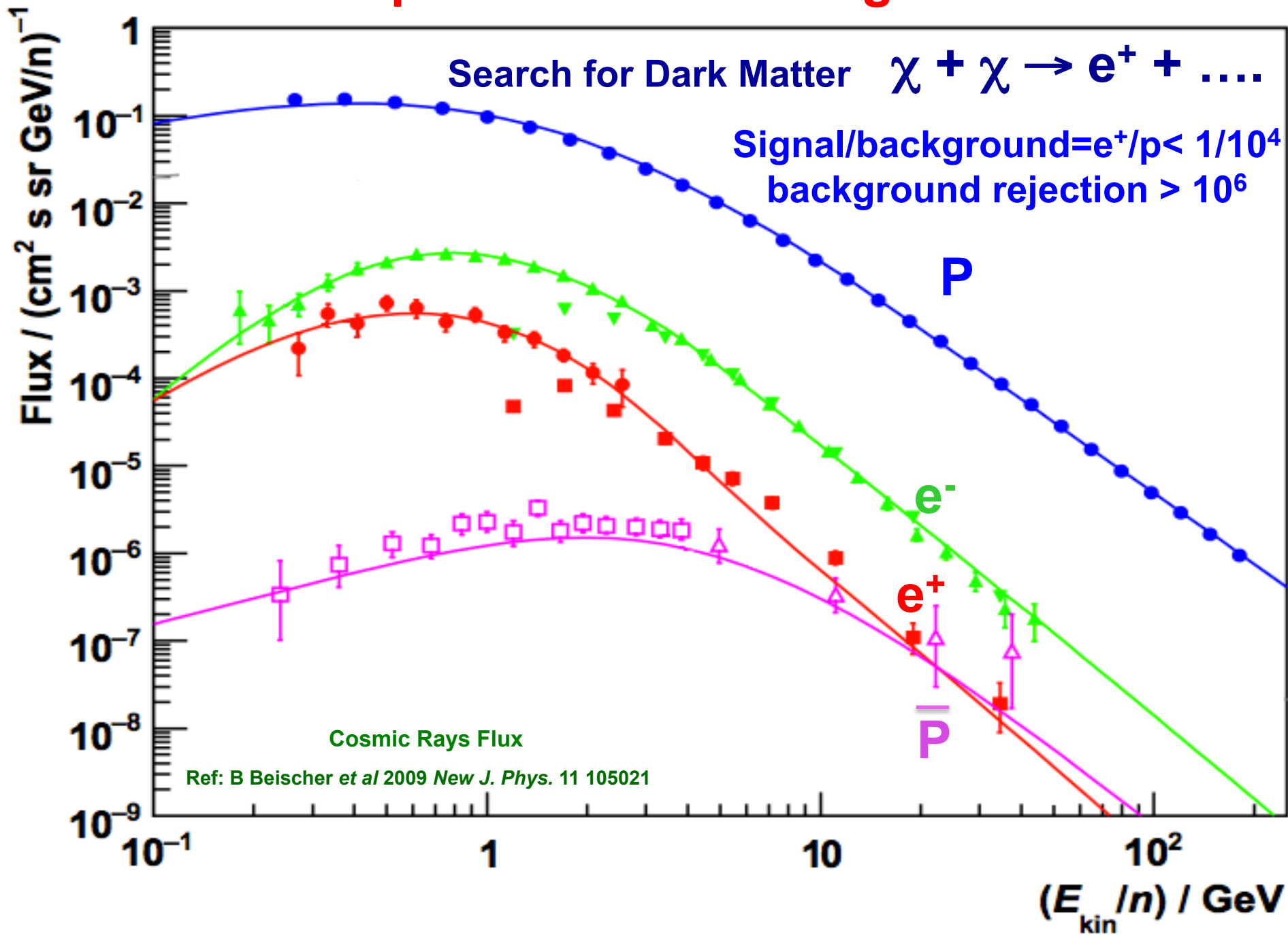

A Large Magnetic Spectrometer in Space : a game changing for the study of Cosmic Ray

L. Baldini 2012

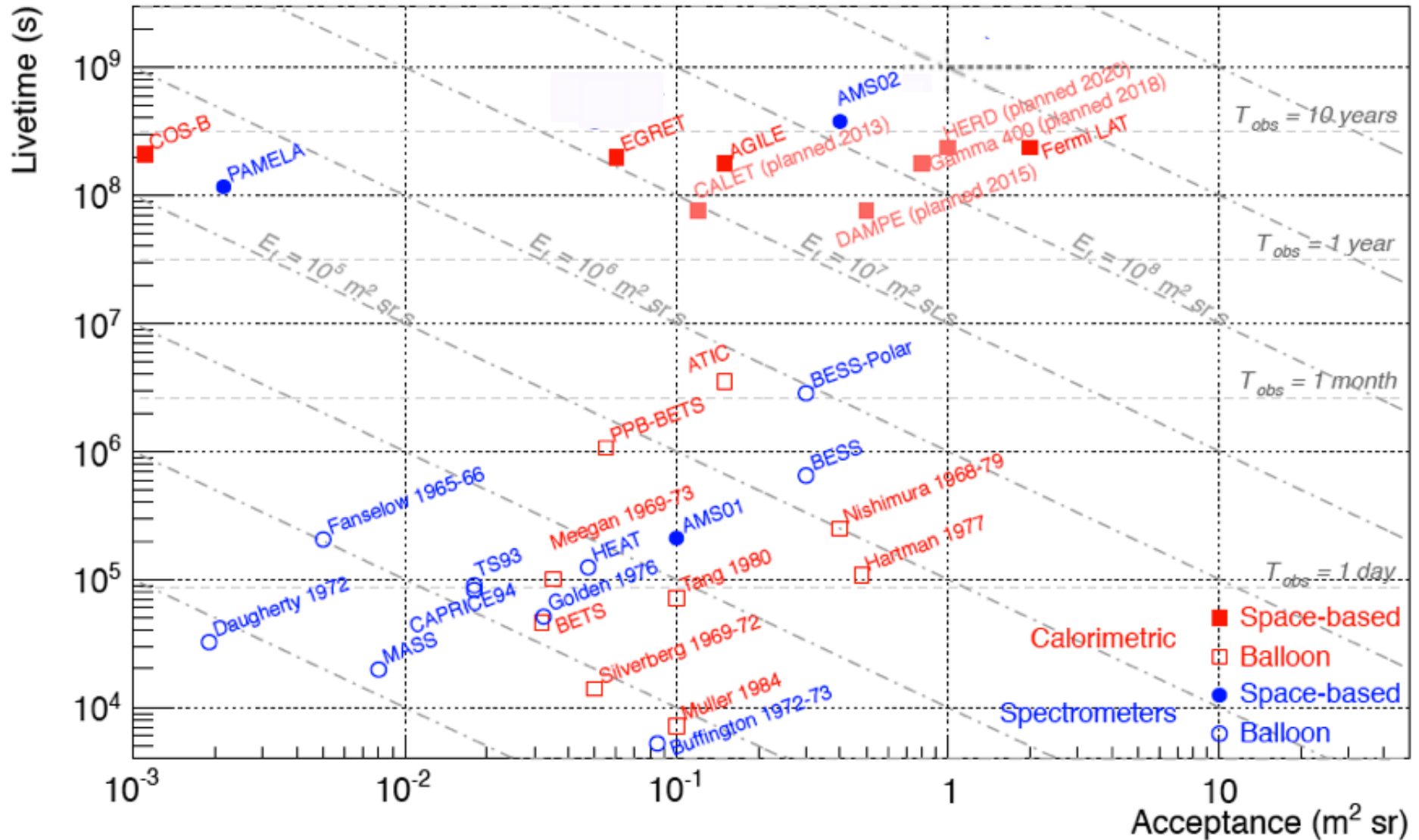

AMS: A TeV precision, multipurpose spectrometer

TRD
Identify e^+ , e^-

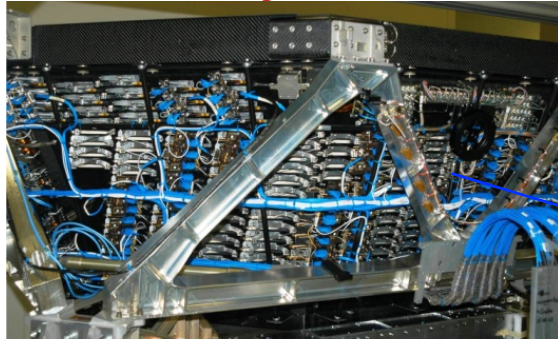

Silicon Tracker
 Z, P

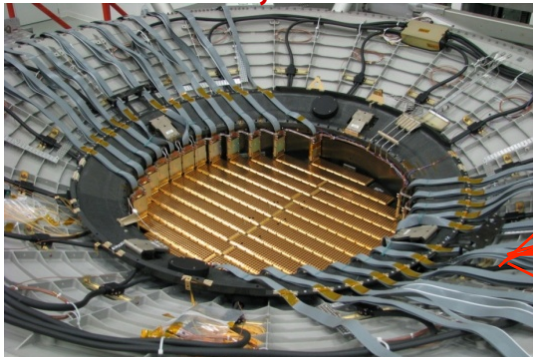

ECAL
 E of e^+ , e^- , γ

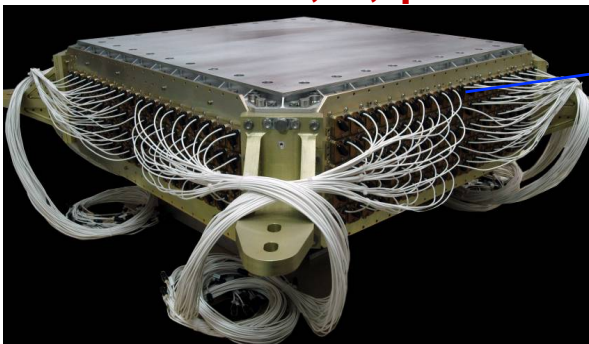

Particles and nuclei are defined by their charge (Z) and energy ($E \sim P$)

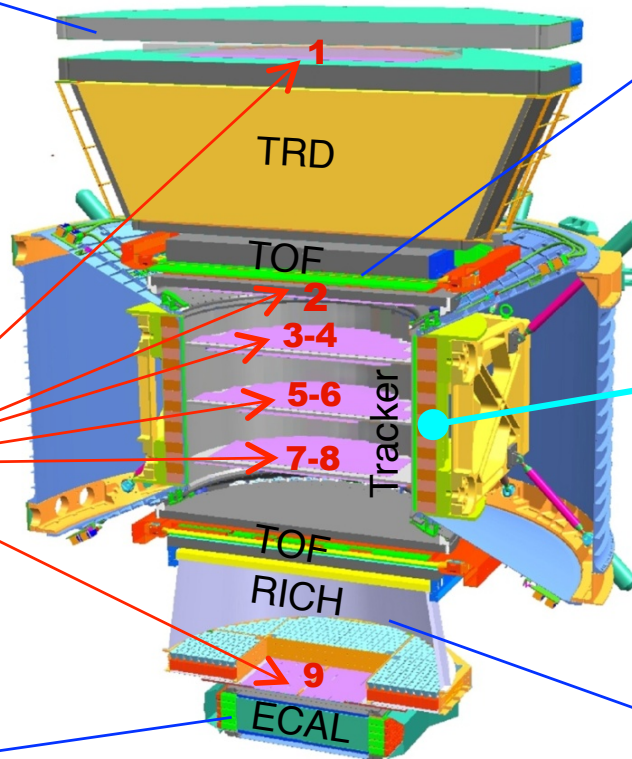

TOF
 Z, E



Magnet
 $\pm Z$

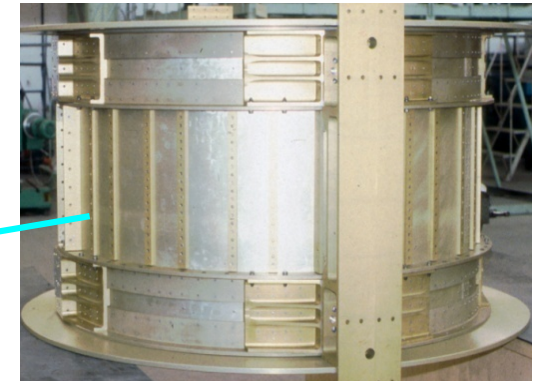

RICH
 Z, E

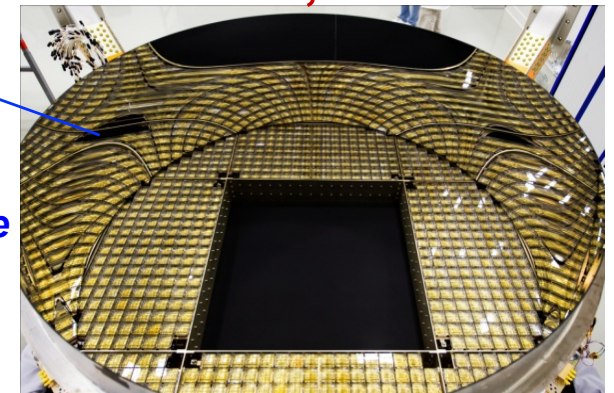

Z, P are measured independently by the Tracker, RICH, TOF and ECAL

AMS International Collaboration

16 Countries, 60 Institutes and 600 Physicists

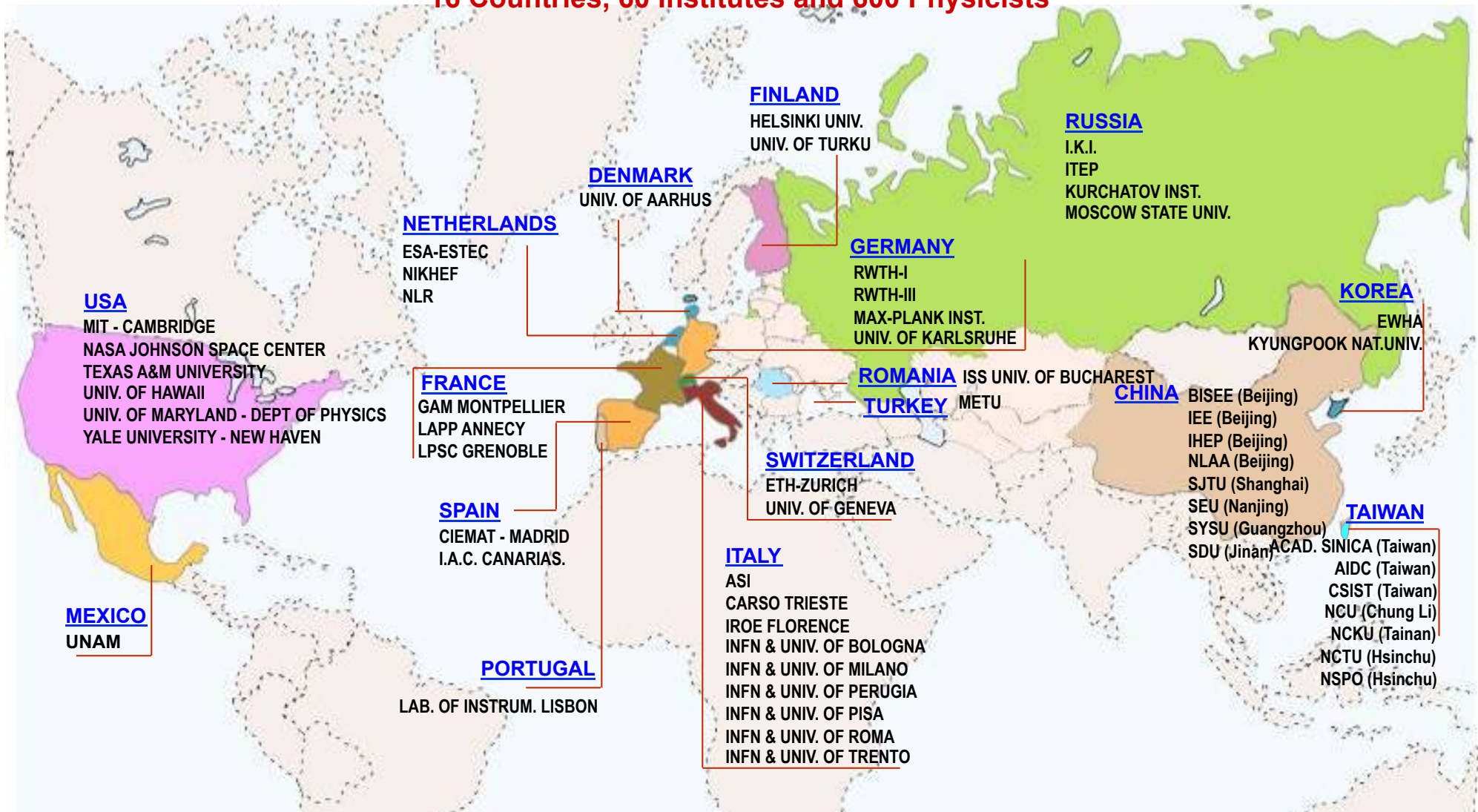

**DOE sponsored experiment, NASA space operation
95% construction from Europe and Asia**

Sensitive Search for the origin of Dark Matter with $p/e^+ > 10^6$

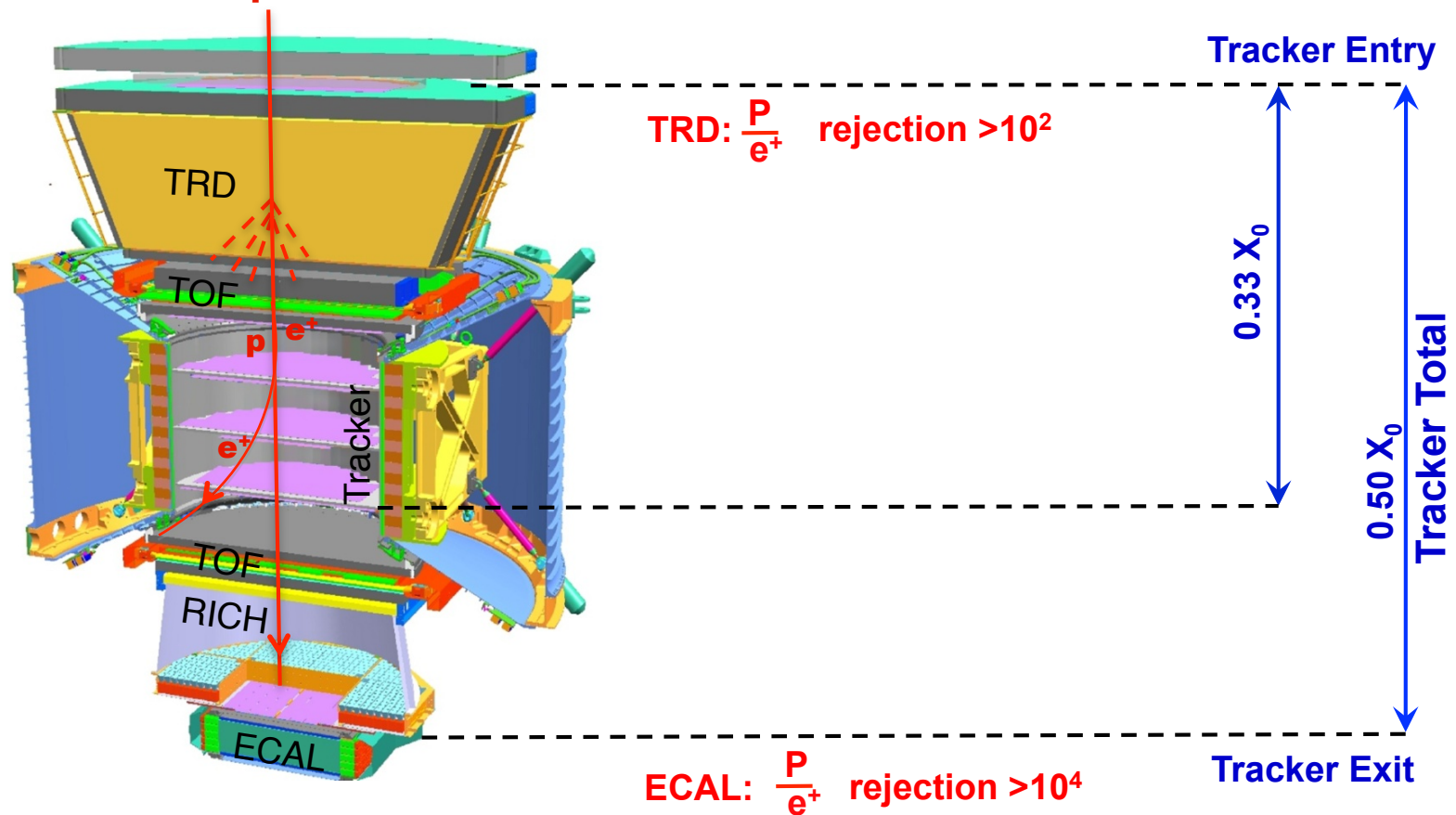

a) Minimal material in the TRD and TOF

So that the detector does not become a source of e^+ .

b) A magnet separates TRD and ECAL so that e^+ produced in TRD will be swept away and not enter ECAL

In this way the rejection power of TRD and ECAL are independent

c) Matching momentum of 9 tracker planes with ECAL energy measurements

AMS Flight Electronics for Data Acquisition (DAQ)

TRD: 5248 Signals

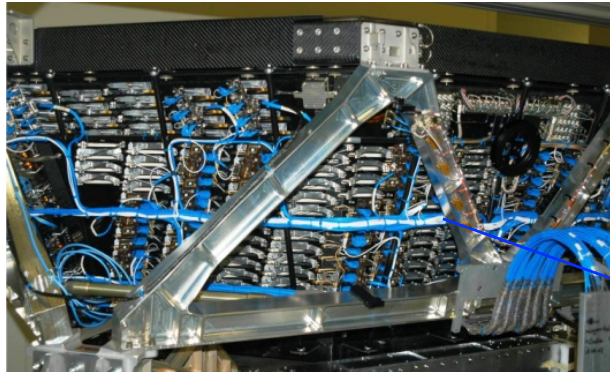

300,000 channels at 2 KHz,
650 computers
designed and built by AMS

TOF & ACC: 88 Signals



Magnet

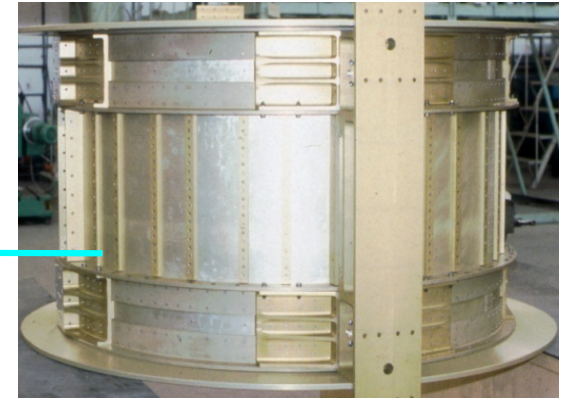

Silicon Tracker:
196,608 Signals

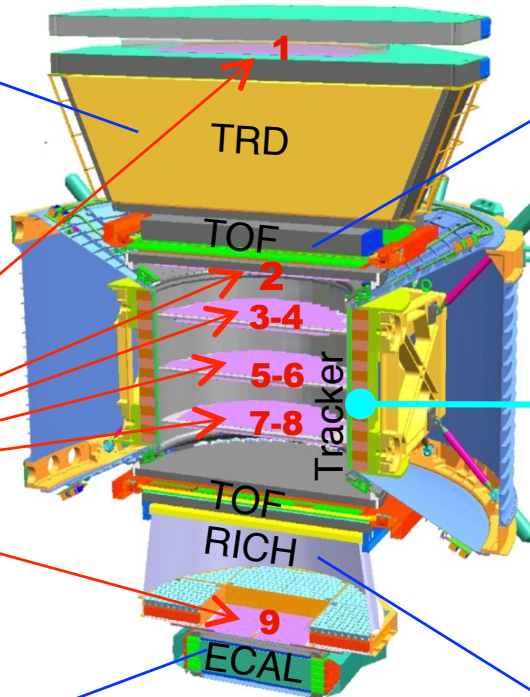
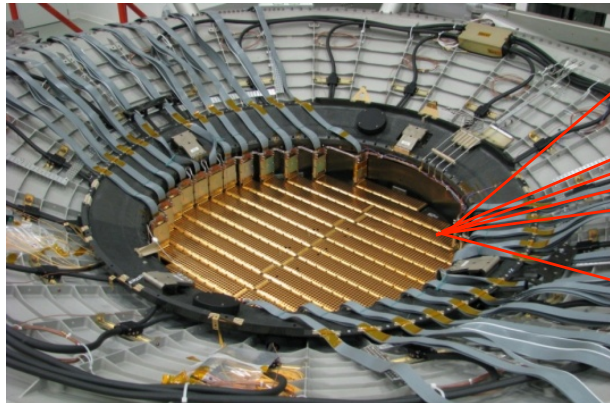

RICH: 10,800 * 2 Signals

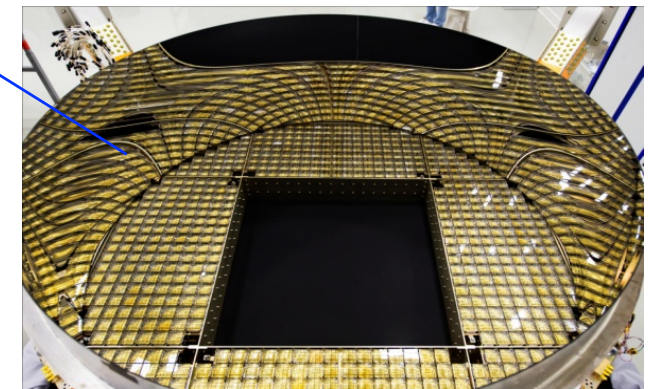

ECAL: 2,916 Signals



AMS Flight Electronics for Thermal Control

1118 temperature sensors, 298 heaters

TRD
24 Heaters
8 Pressure Sensors
482 Temperature Sensors

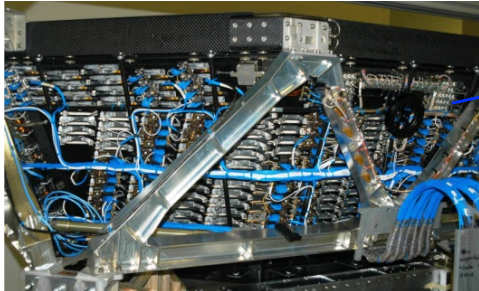

TOF & ACC
64 Temperature Sensors



Silicon Tracker
4 -Pressure Sensors
32 Heaters
142 Temperature Sensors

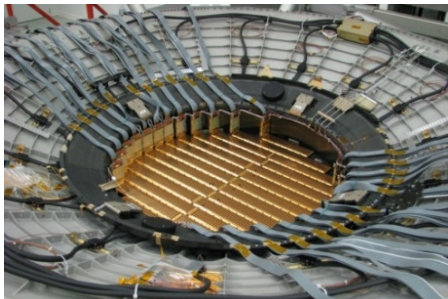

Magnet
68 Temperature Sensors

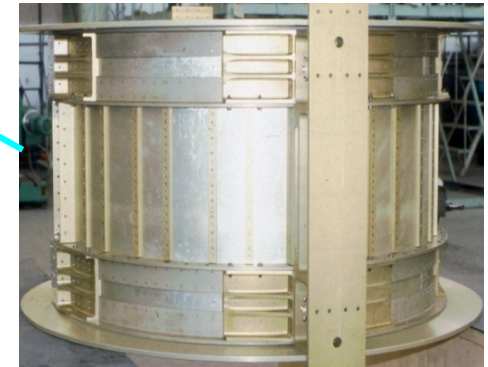

ECAL
80 Temperature Sensors

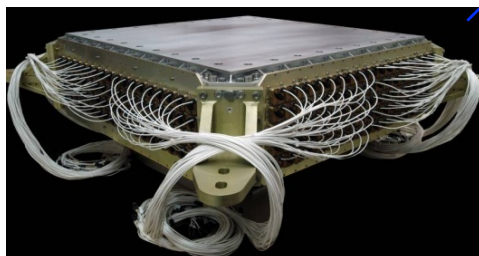

RICH
96 Temperature Sensors

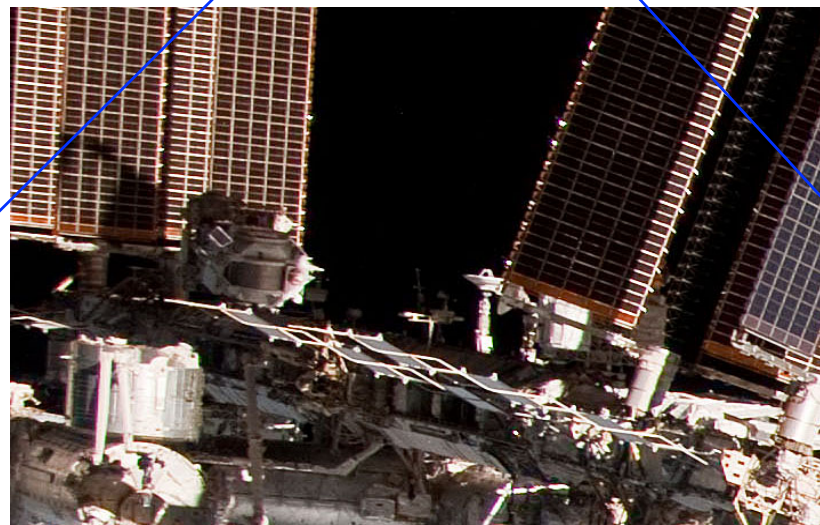
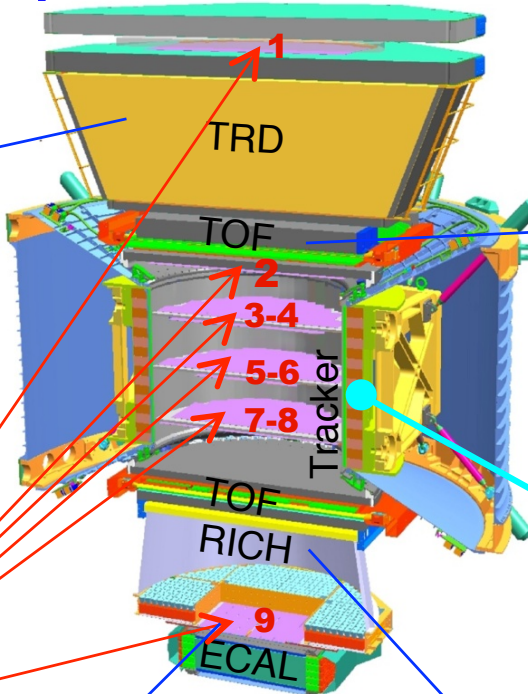
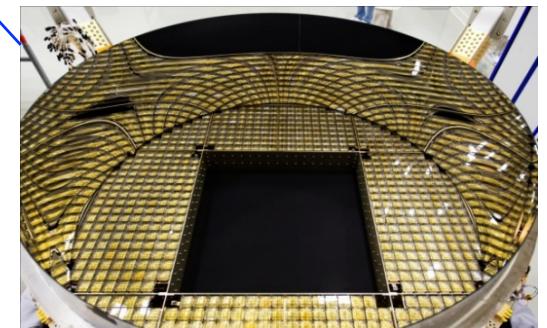

The Magnet

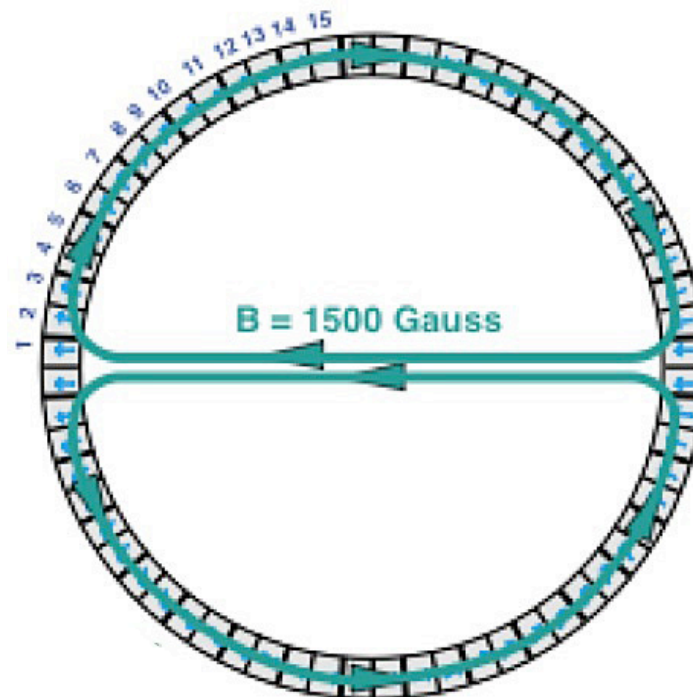
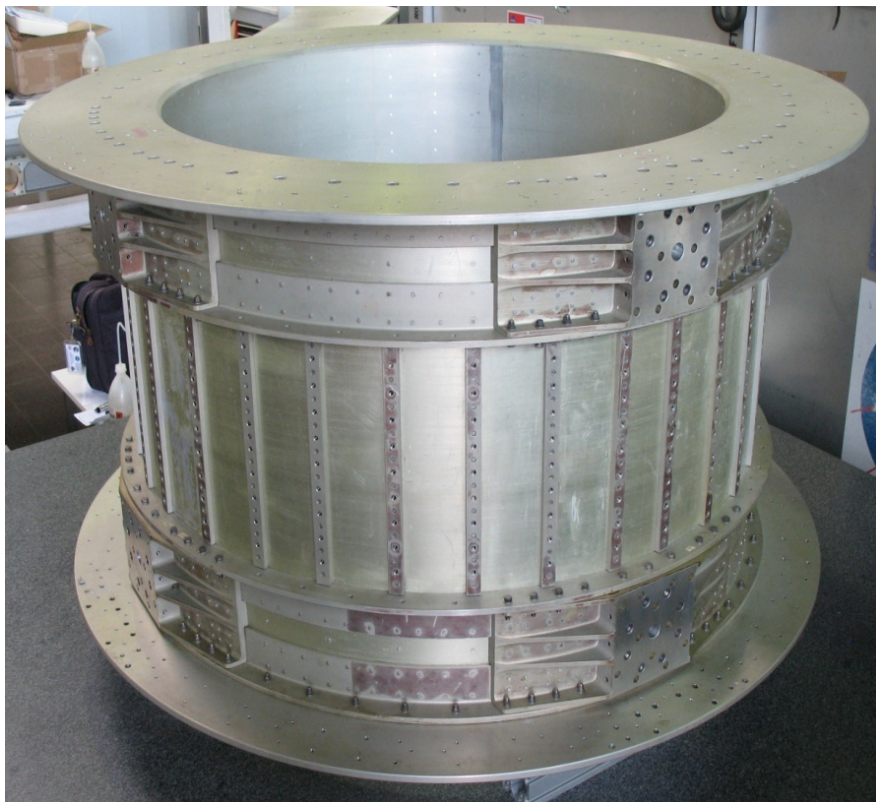

1. Stable: no torque
2. Safety : no field leak out of the magnet
- 3 . Low weight: no iron

The detailed 3D field map (120k locations)
was measured in May 2010

It was found that the deviation from
the 1997 measurement had
remained the same to <1%

For AMS, 10 Magnets were made:



**Seven magnets to understand
the field calculation, leakage and dipole moment**

**Three full-size magnets for
1) space qualification, 2) destructive testing and 3) flight**

**The magnetic field measured in May 2010 (120K location) is identical to the measurement in
September 1997**

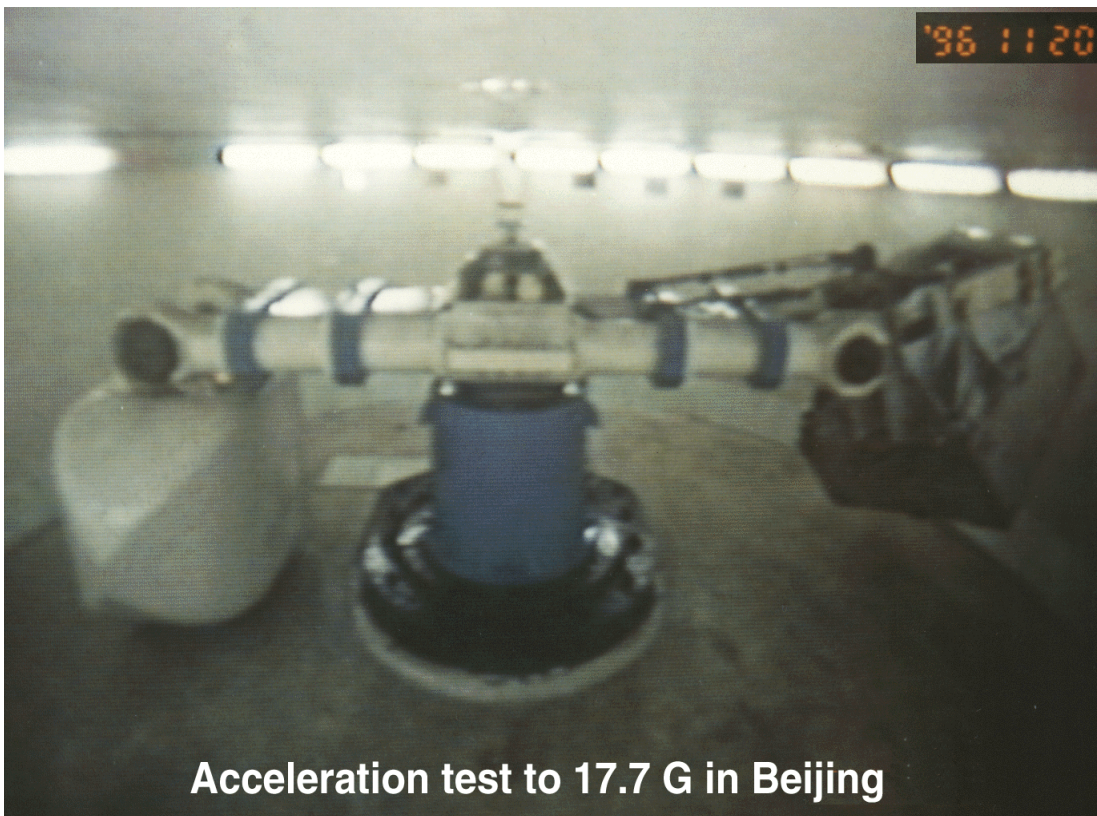

Acceleration test to 17.7 G in Beijing

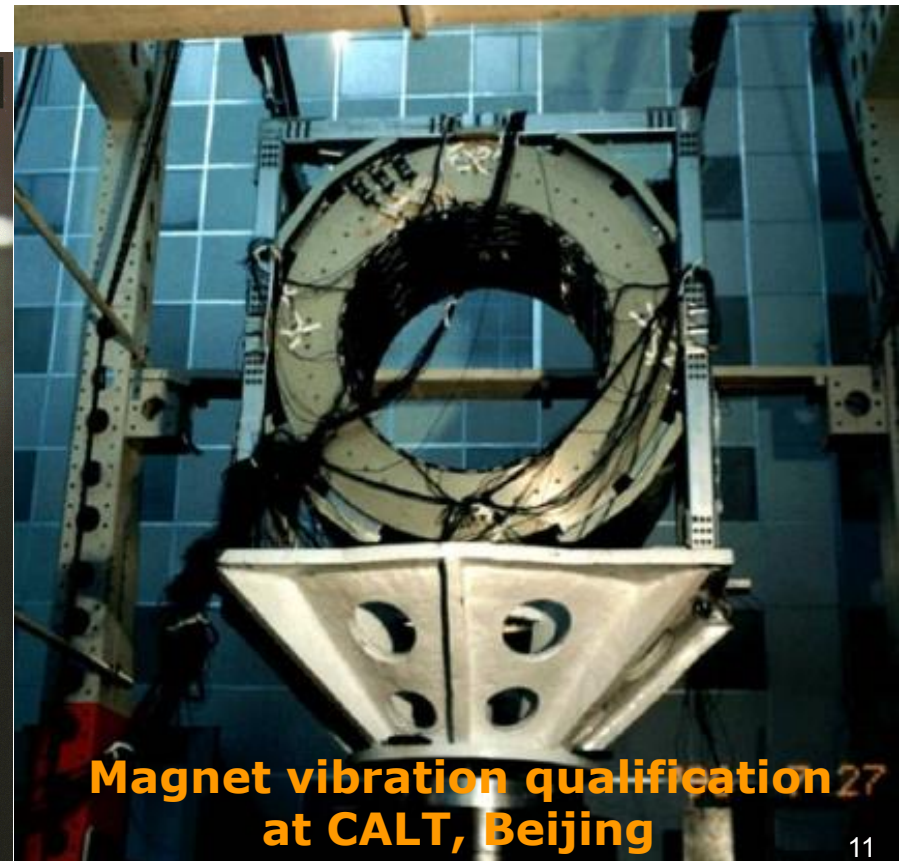

**Magnet vibration qualification²⁷
at CALT, Beijing**

Deviation from 1997 measurements in R-Phi coordinates, Z=0

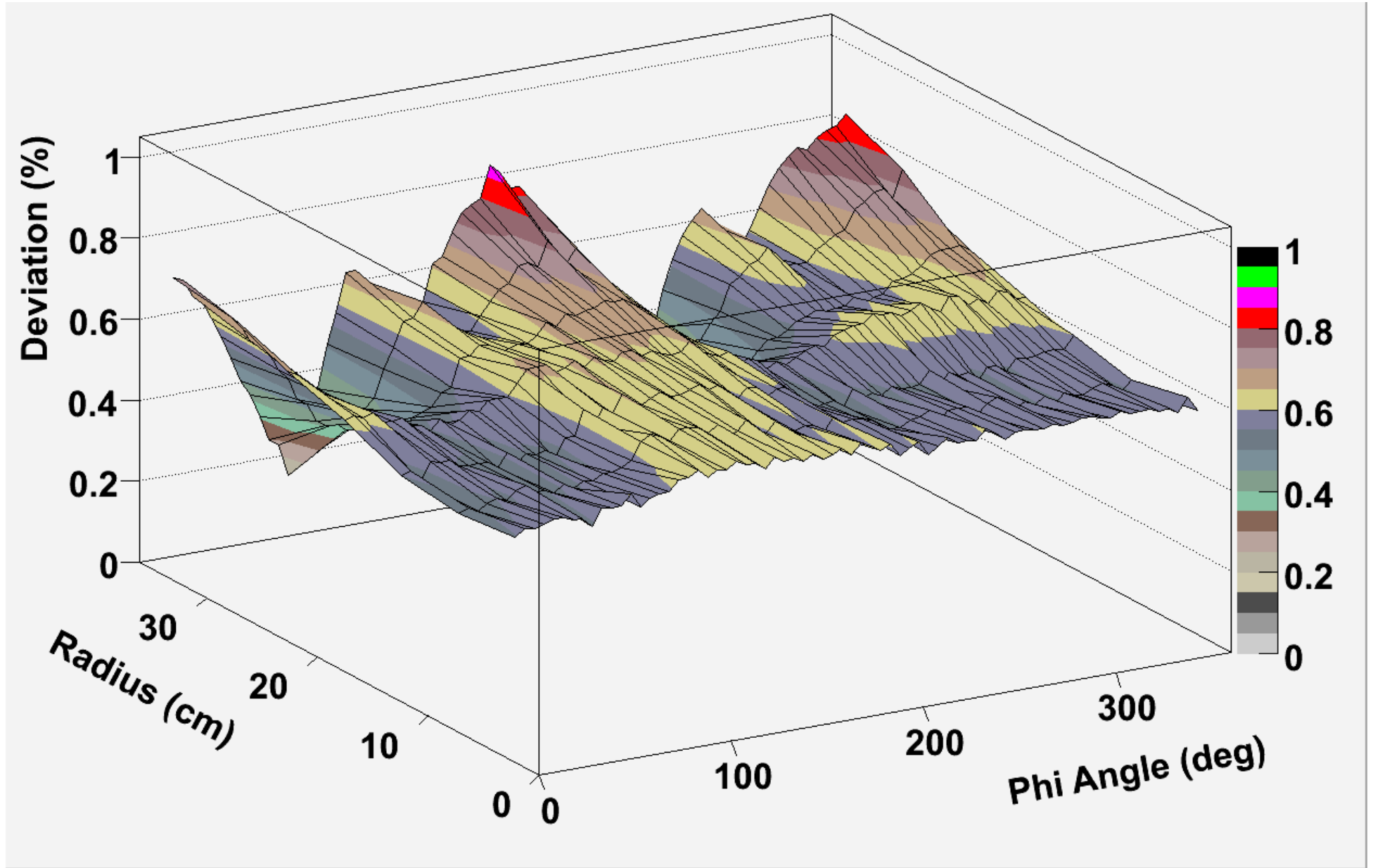

Transition Radiation Detector (TRD) Identifies Positrons, Electrons by transition radiation and Nuclei by dE/dX

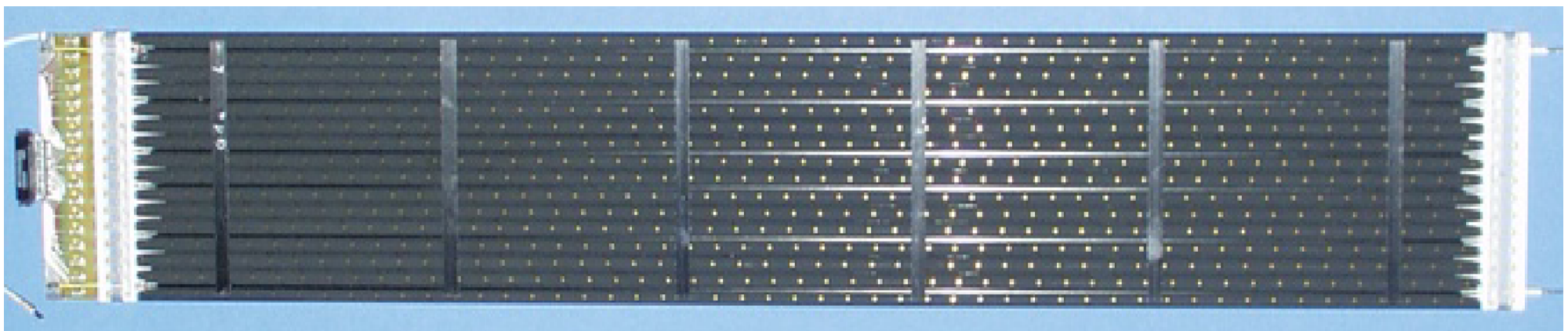
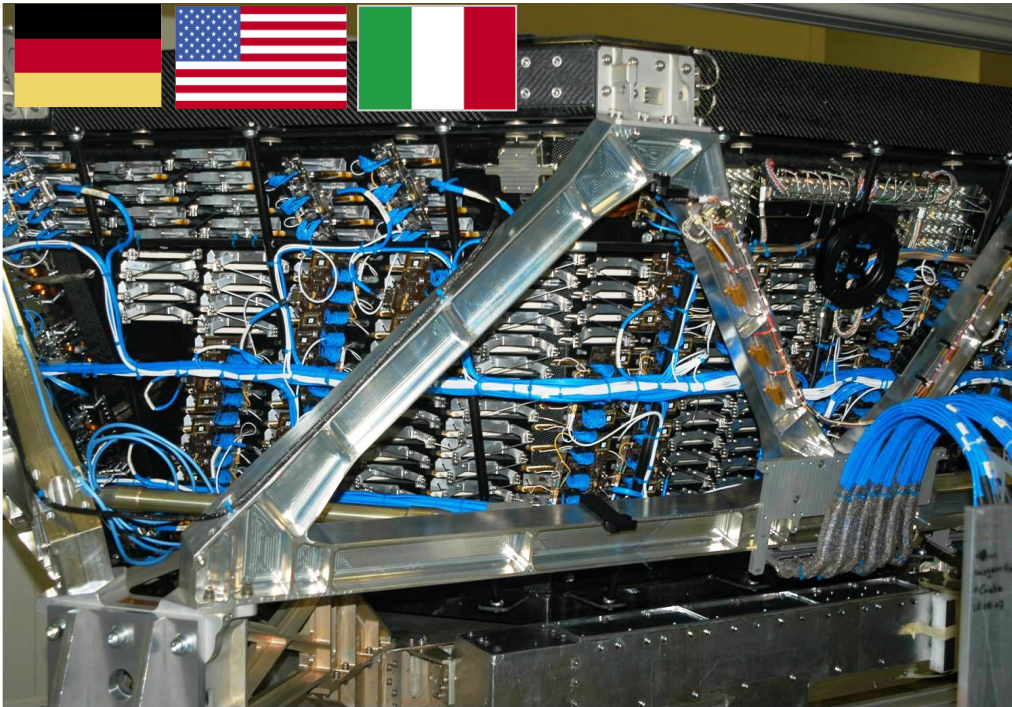

5,248 tubes selected from 9,000, 2 m length centered to $100\mu\text{m}$, verified by CAT scanner

TRD performance on ISS

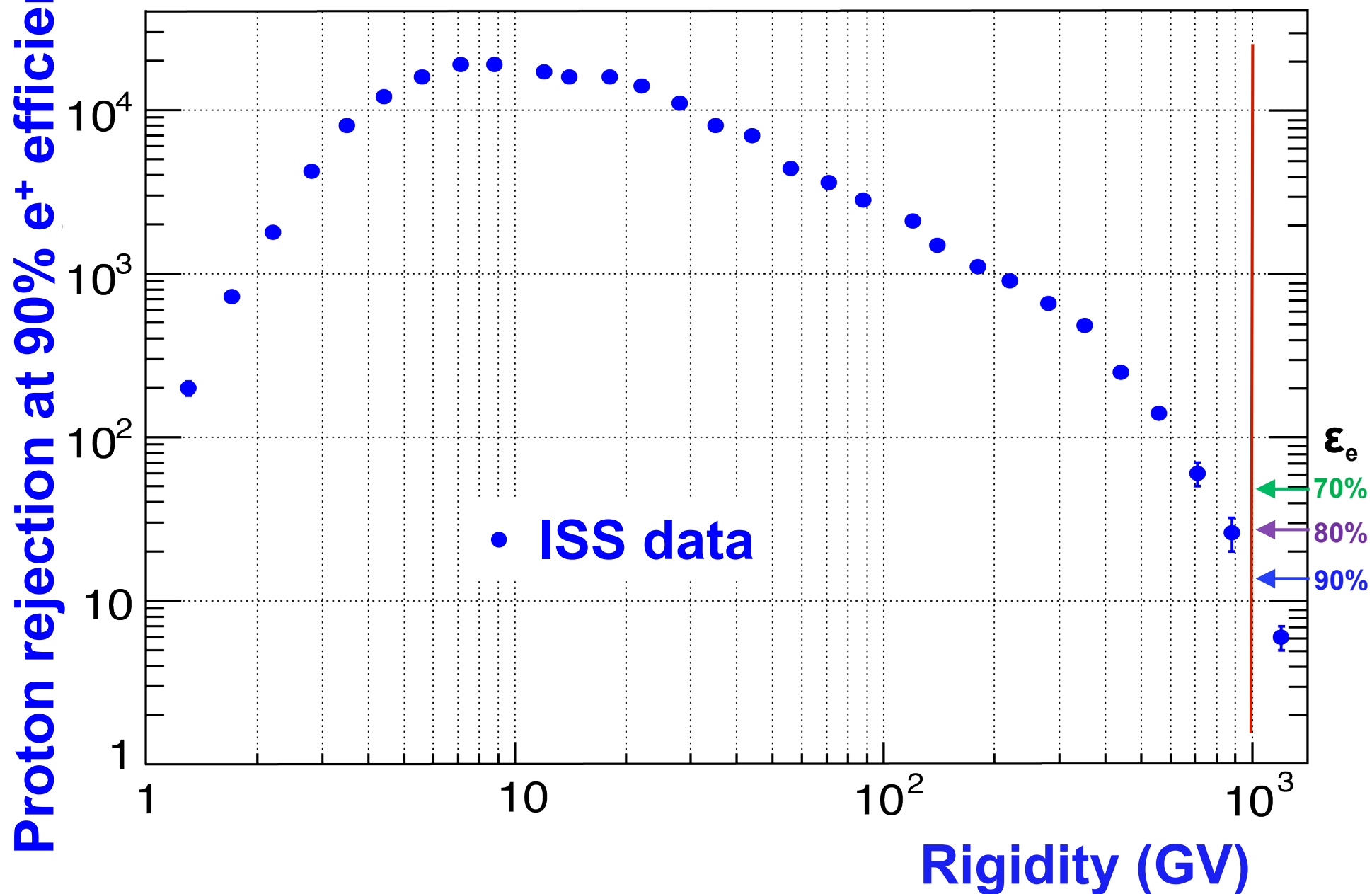



Data from ISS

Time of Flight System

Measures Velocity and Charge of particles

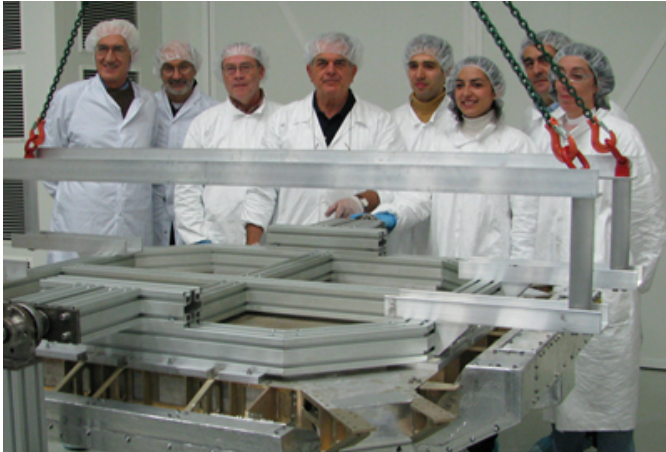

Bologna

Professors A. Contin, G. Laurenti, F. Palmonari

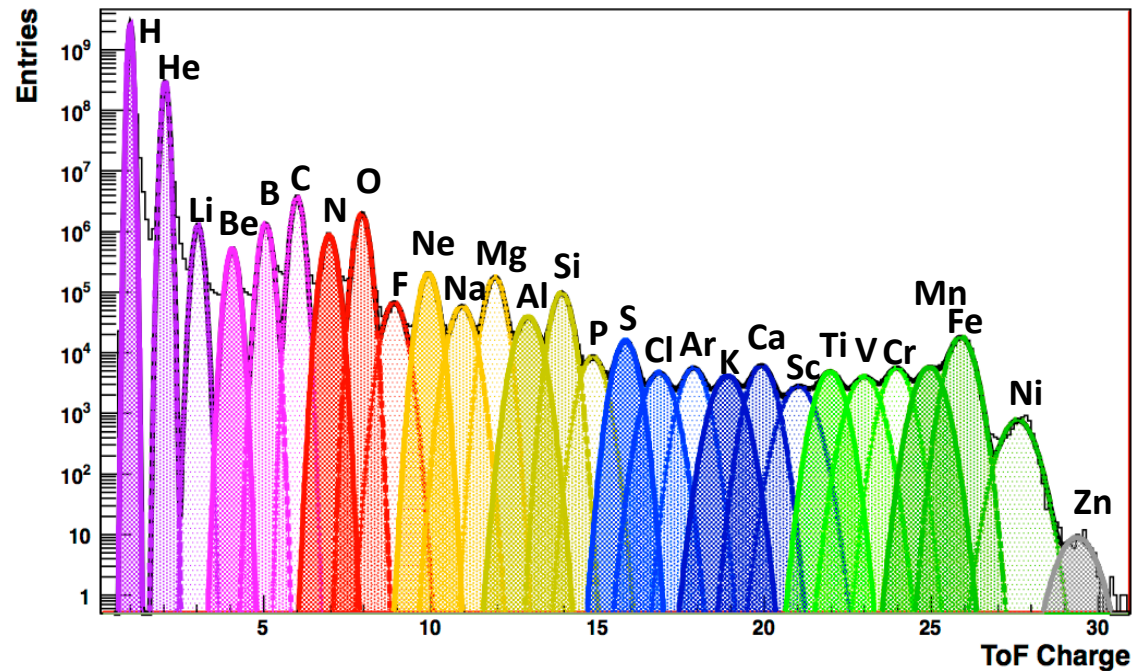
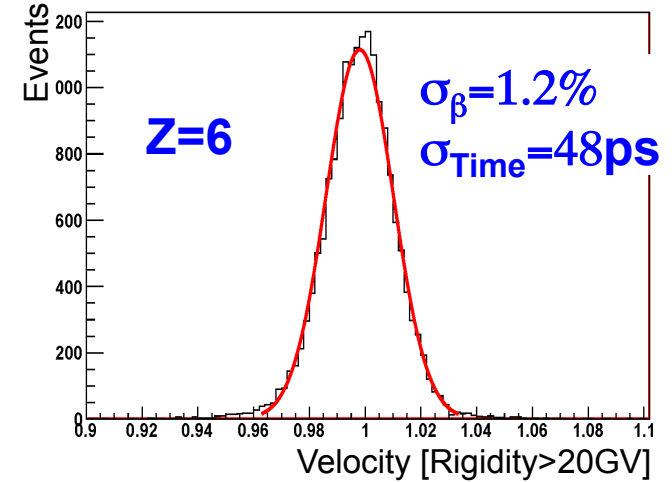
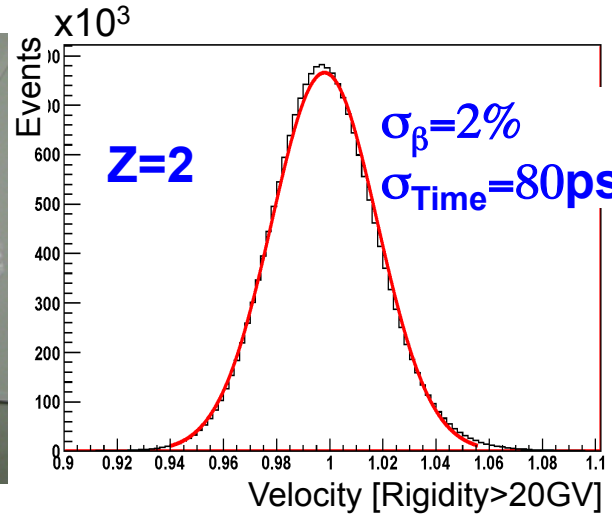

Silicon Tracker



Coordinator

G. Ambrosi INFN-Perugia

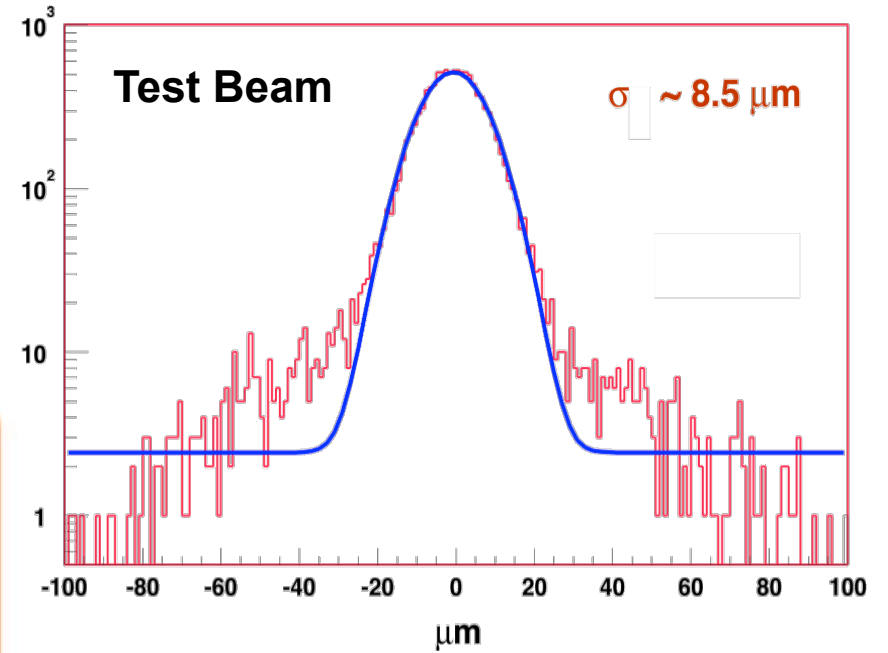
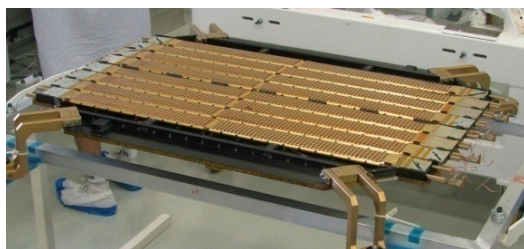
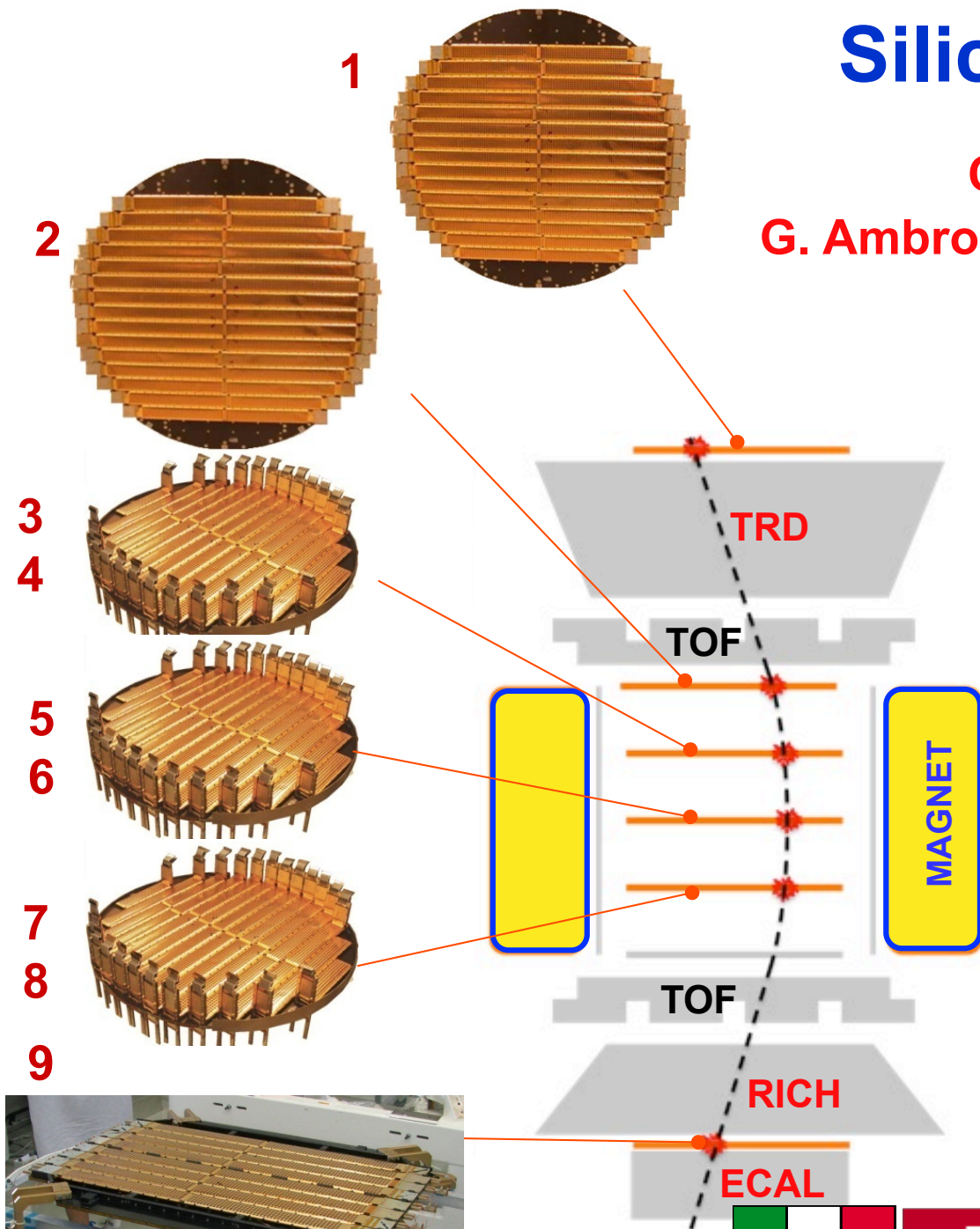

MDR $\sim 2.0 \text{ TV}$

E / |p| matching



AMS Group at INFN and University of Perugia





Professor B. Bertucci, Perugia

There are 9 planes with 200,000 channels aligned to 3 microns

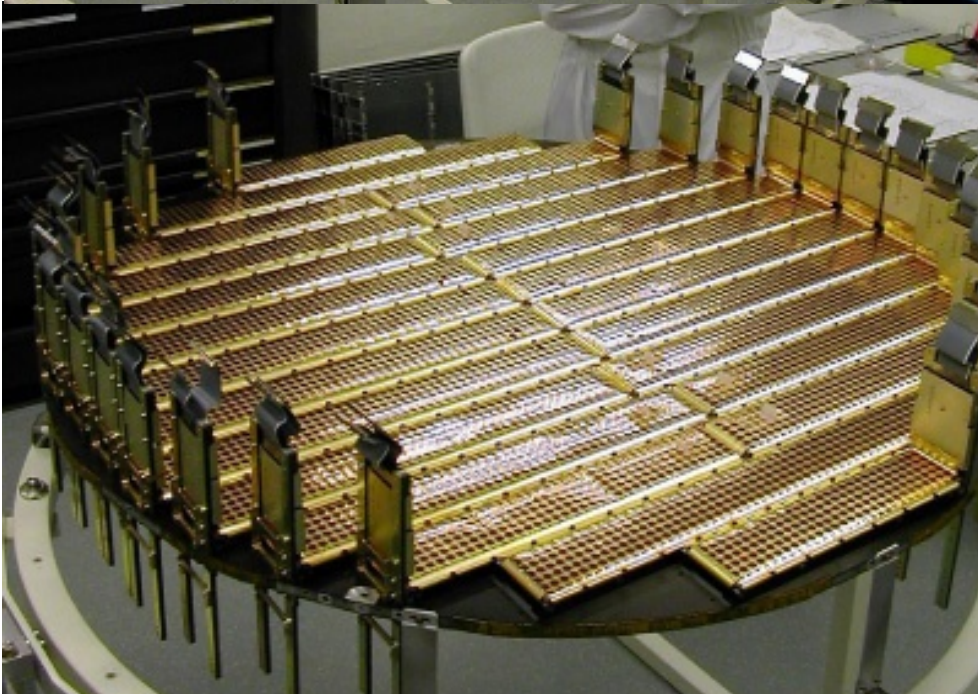
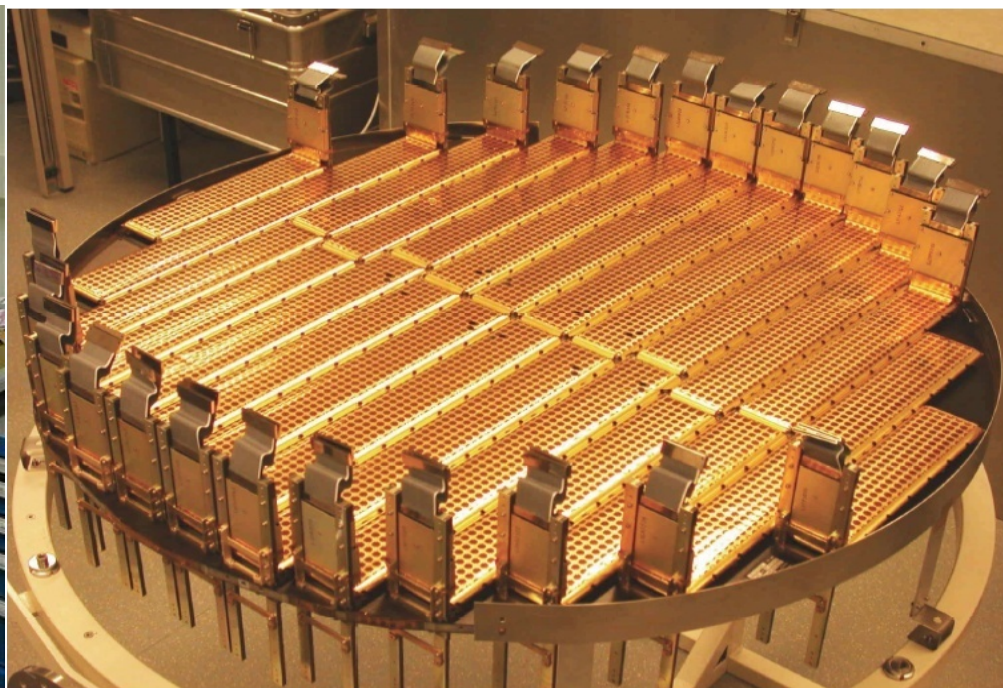
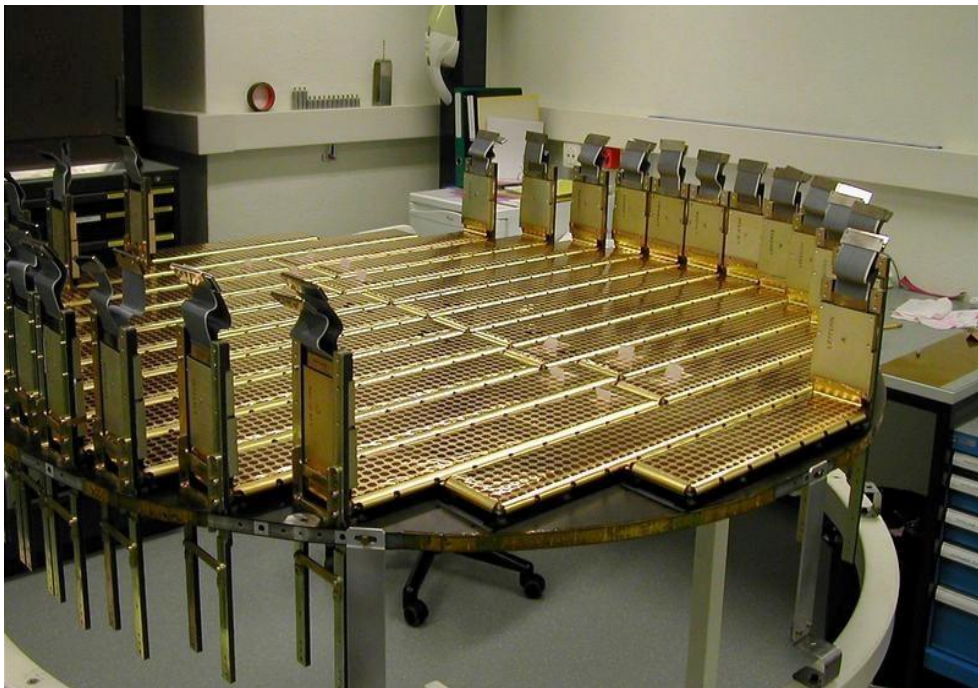

Tracker explained to US Senator B. Nelson, G. Bignami (ASI), J. Woerner (DLR)



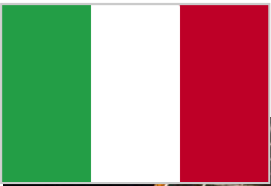

Tracker Thermal Control System in Space

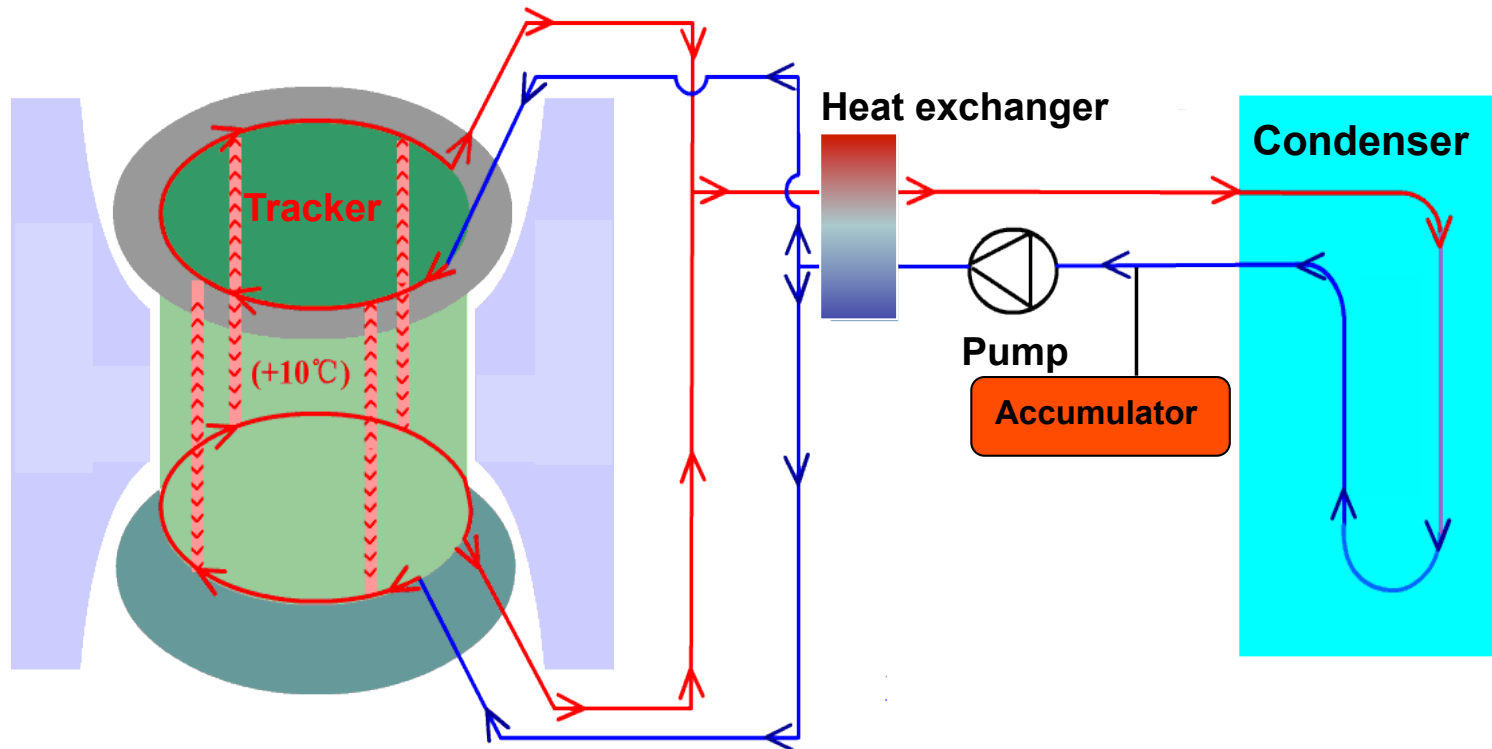

Red line: CO₂ gas/liquid two phase

Blue line: CO₂ liquid phase

Alignment accuracy of the 9 Tracker layers over 18 months

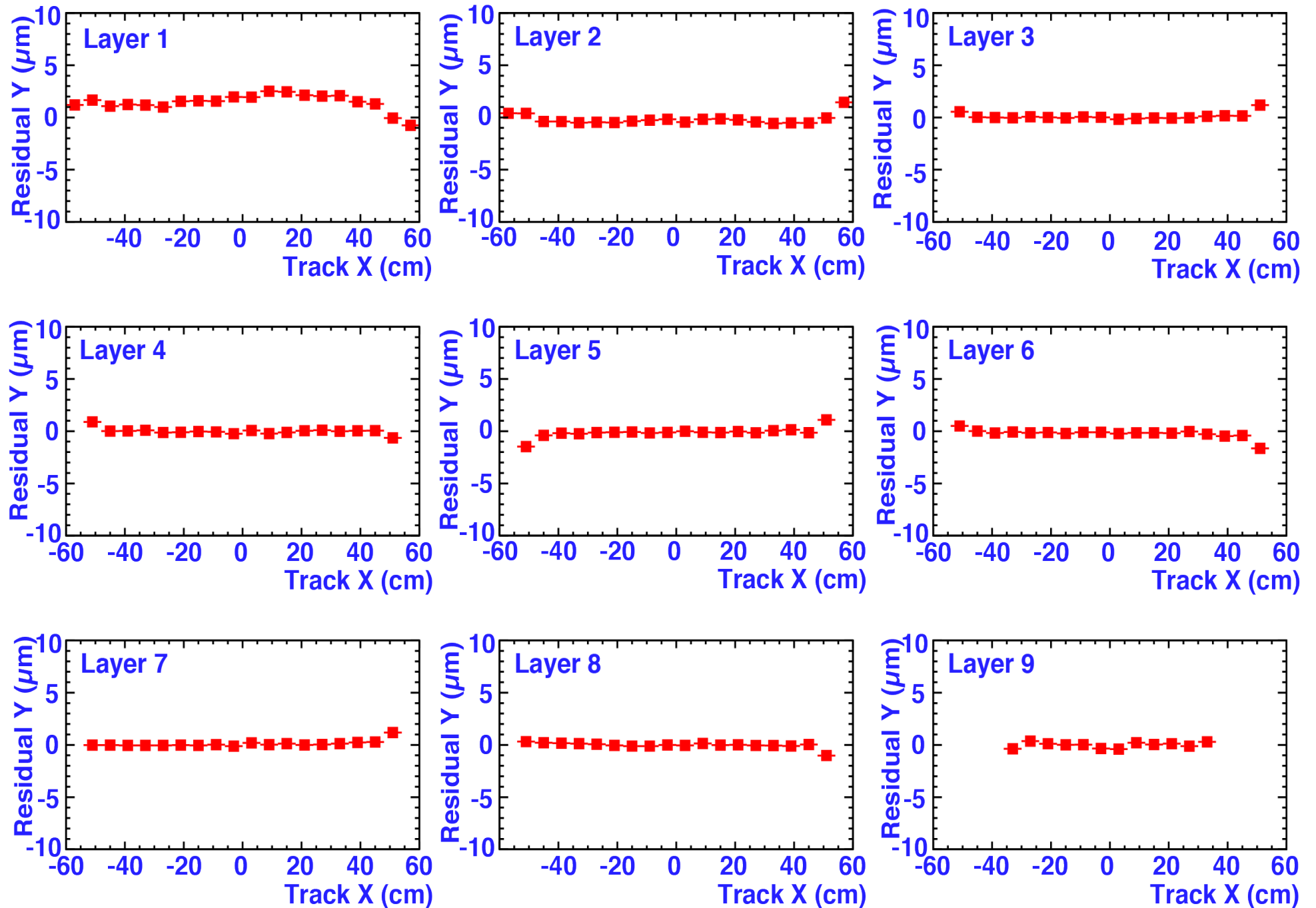

Ring Imaging CHerenkov (RICH)

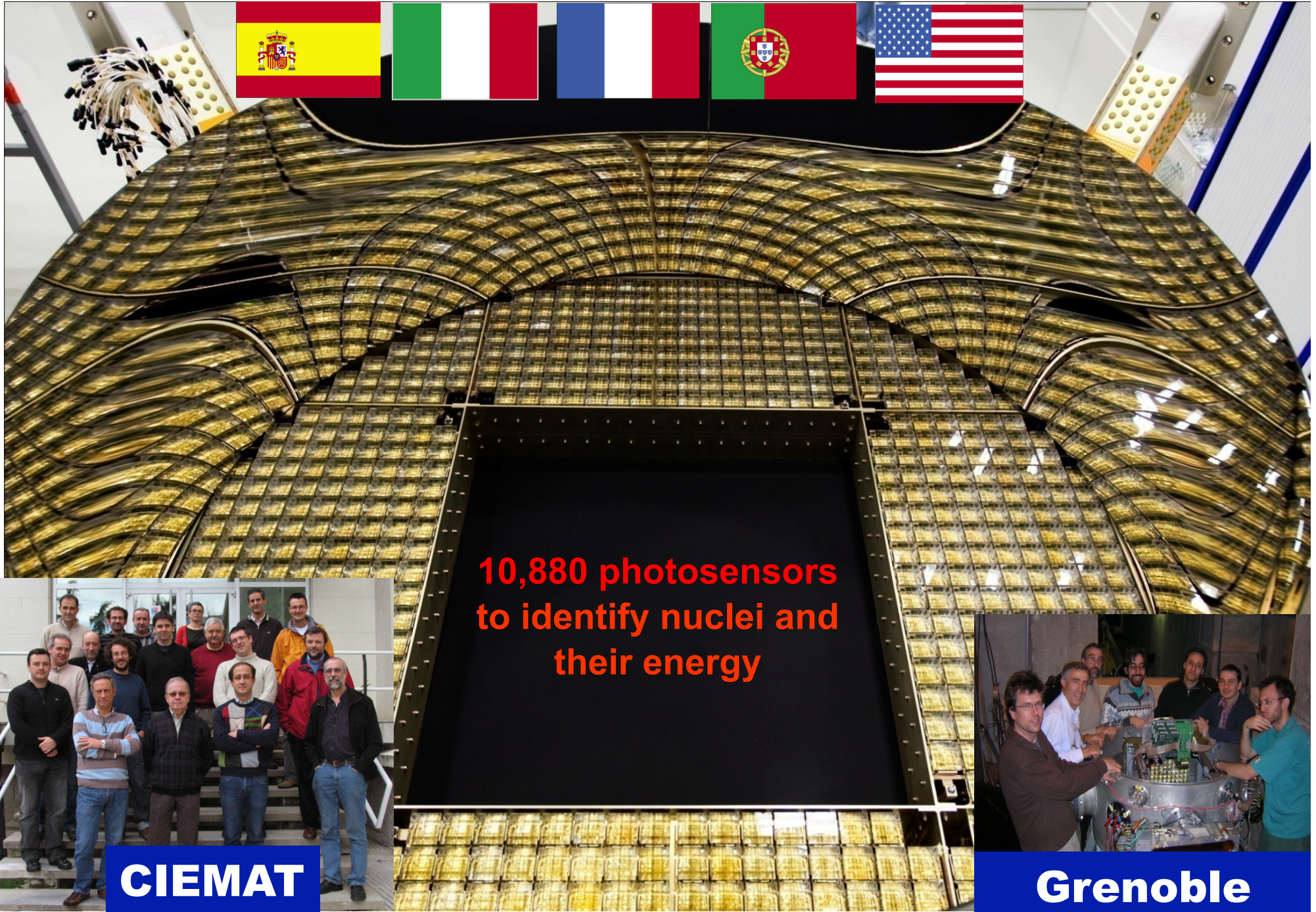

10,880 photosensors
to identify nuclei and
their energy



CIEMAT



Grenoble

Detector performance on ISS RICH

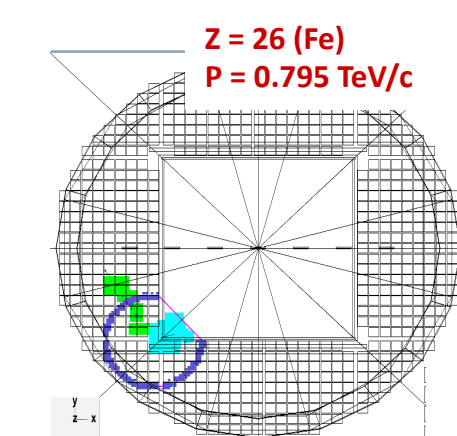
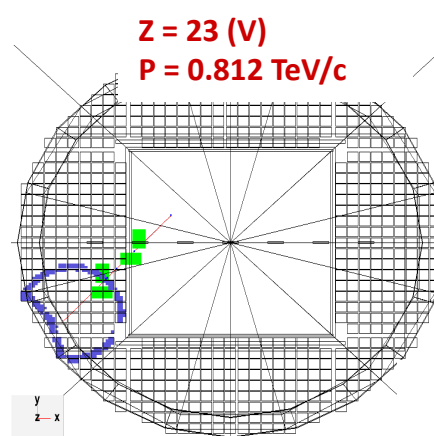
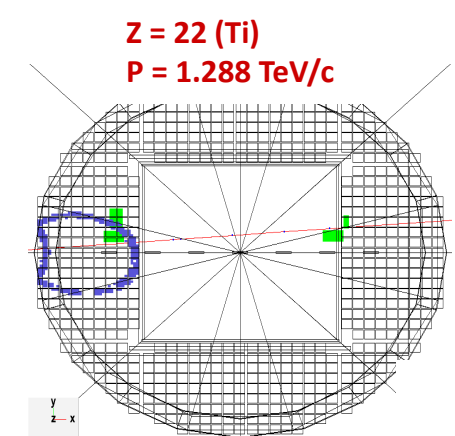
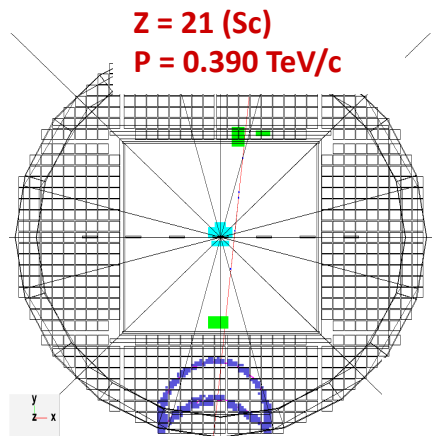
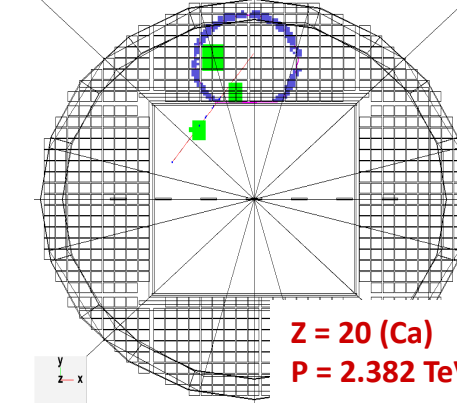
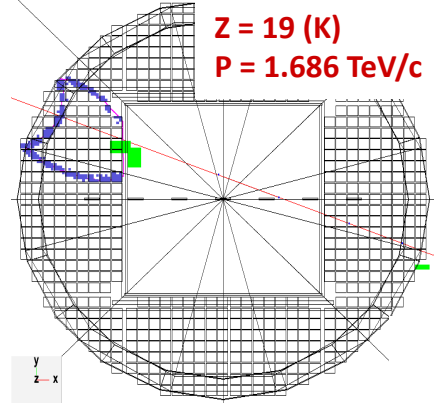
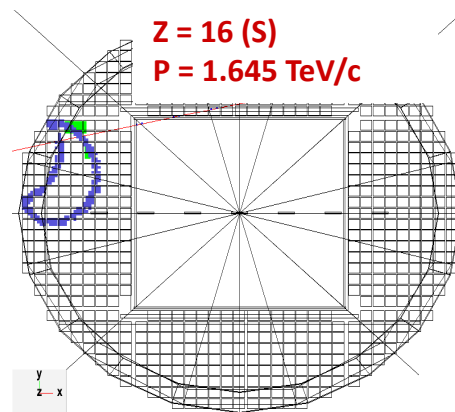
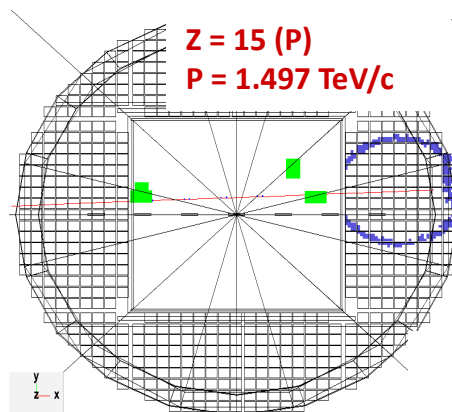
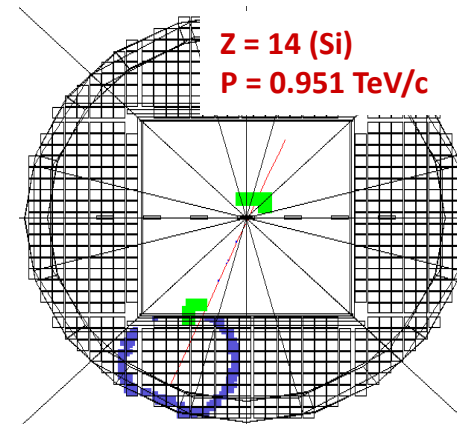
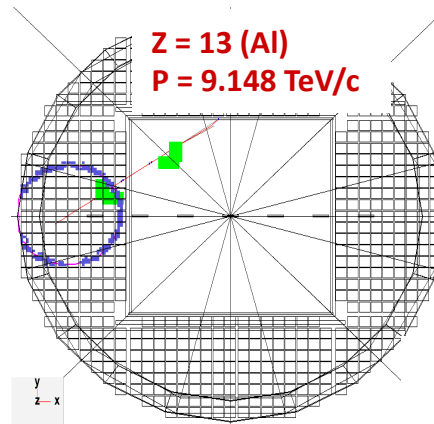
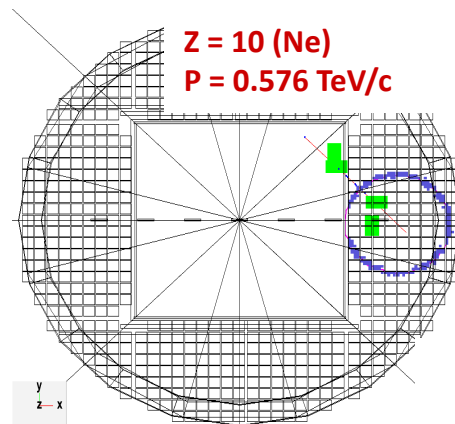
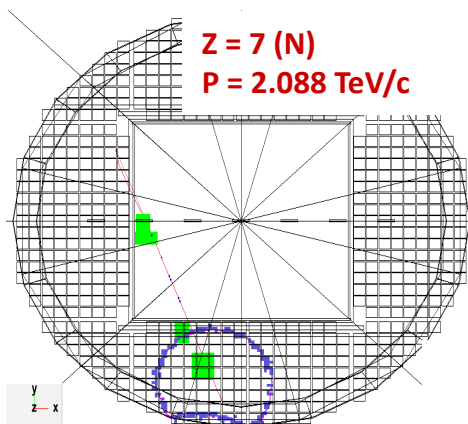

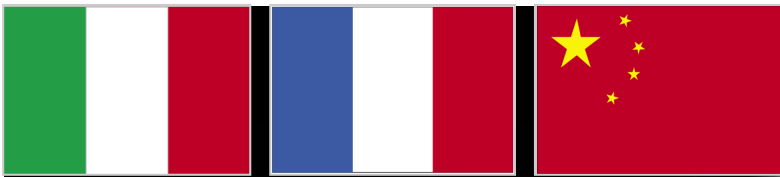

Calorimeter (ECAL)



50,000 fibers, $\phi = 1\text{mm}$, distributed uniformly inside 600 kg of lead which provides a precision, 3-dimensional, $17X_0$ measurement of the directions and energies of light rays and electrons up to 1 TeV

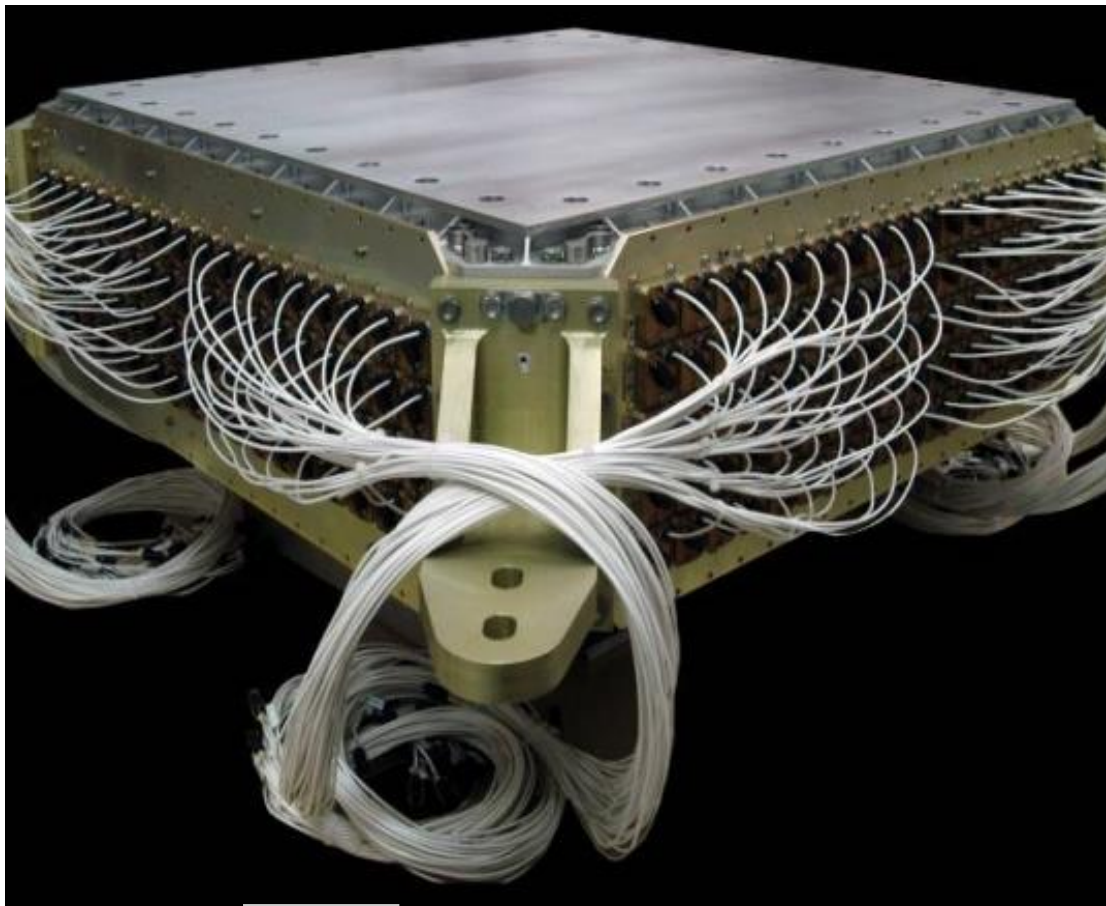

中國運載火箭技術研究院
CHINA ACADEMY OF LAUNCH VEHICLE TECHNOLOGY



Pisa



LAPP

ECAL Performance

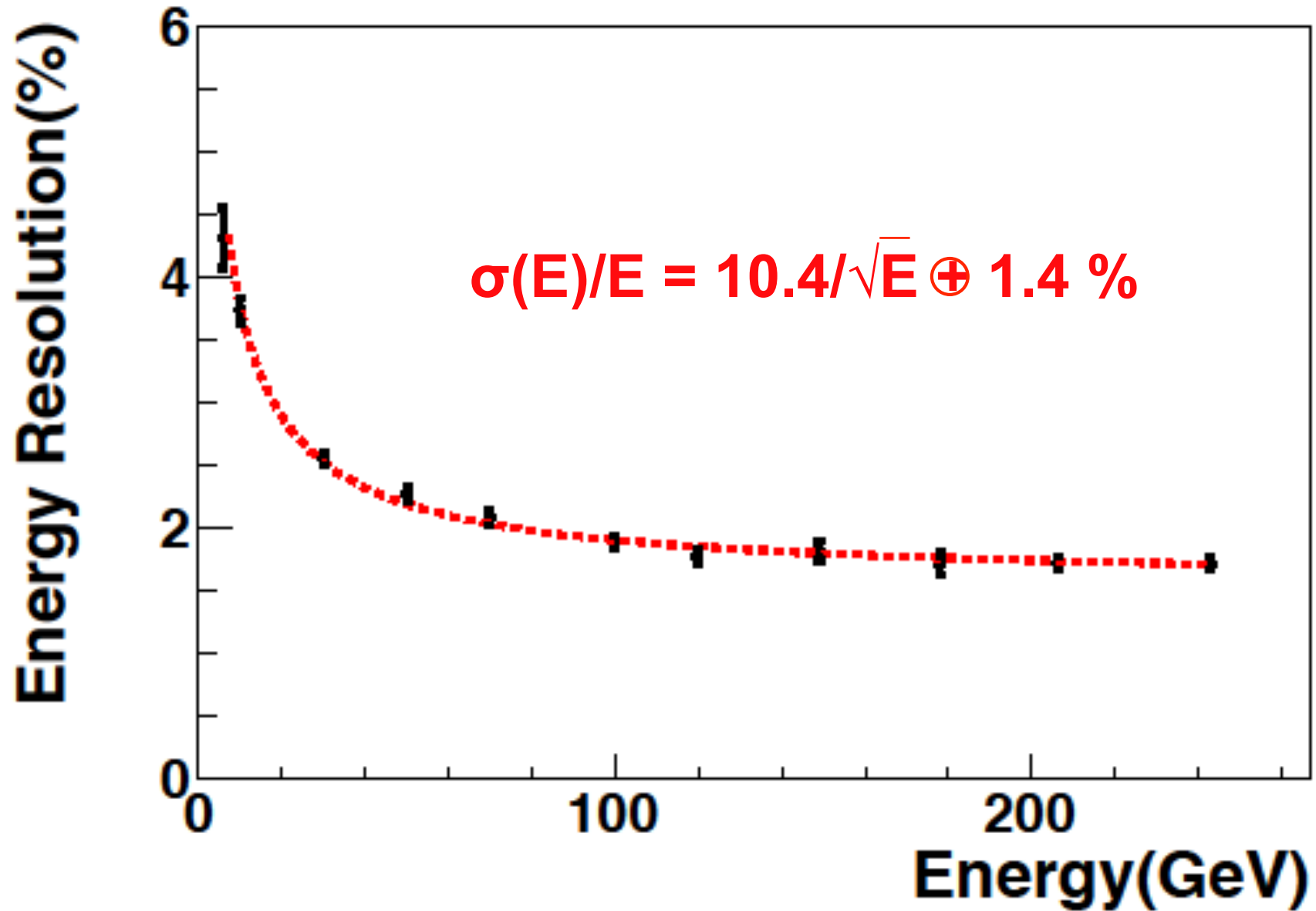

Data from ISS: Proton rejection using the ECAL

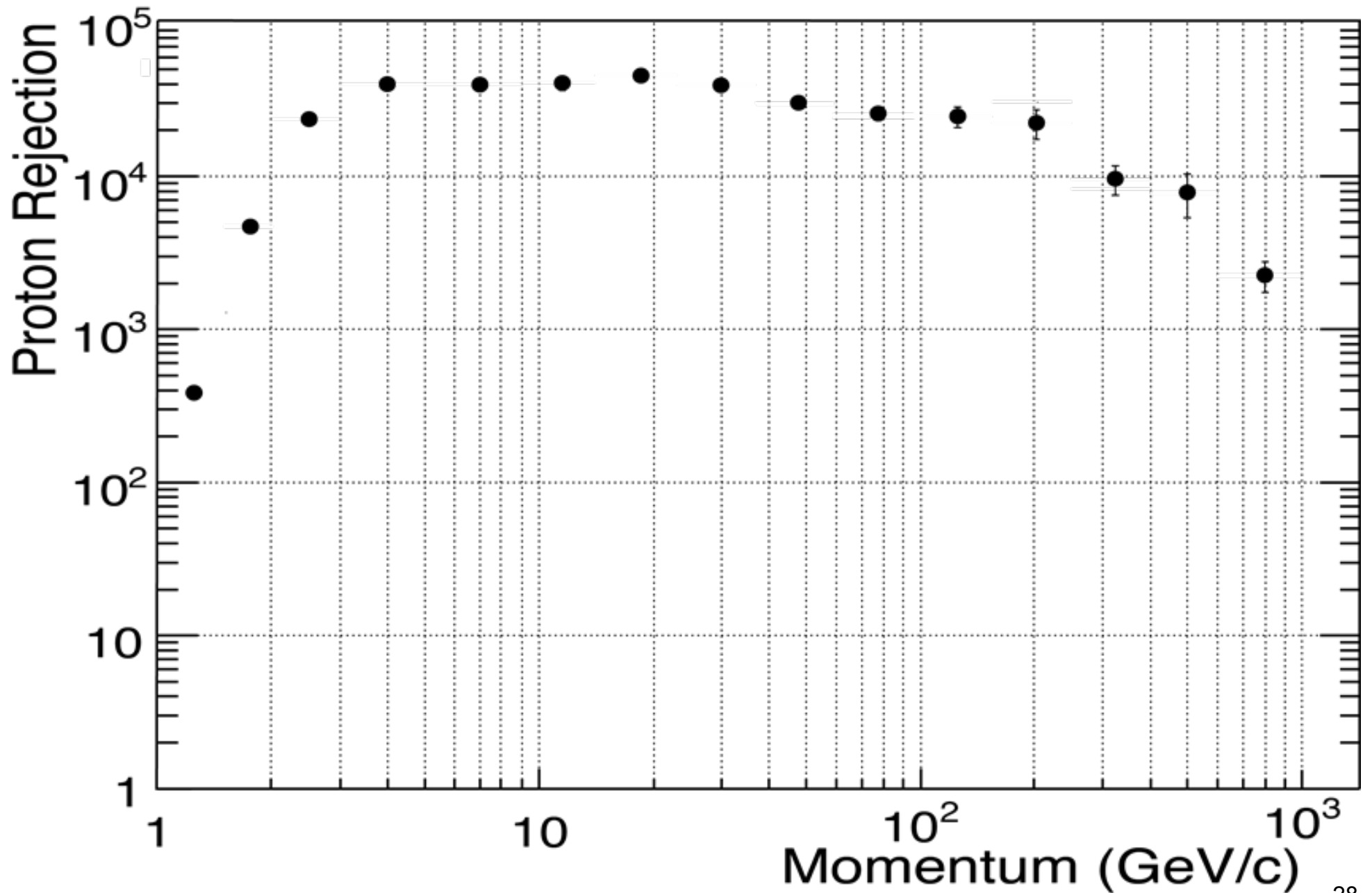

Flight Electronics for DAQ

Trigger Computers

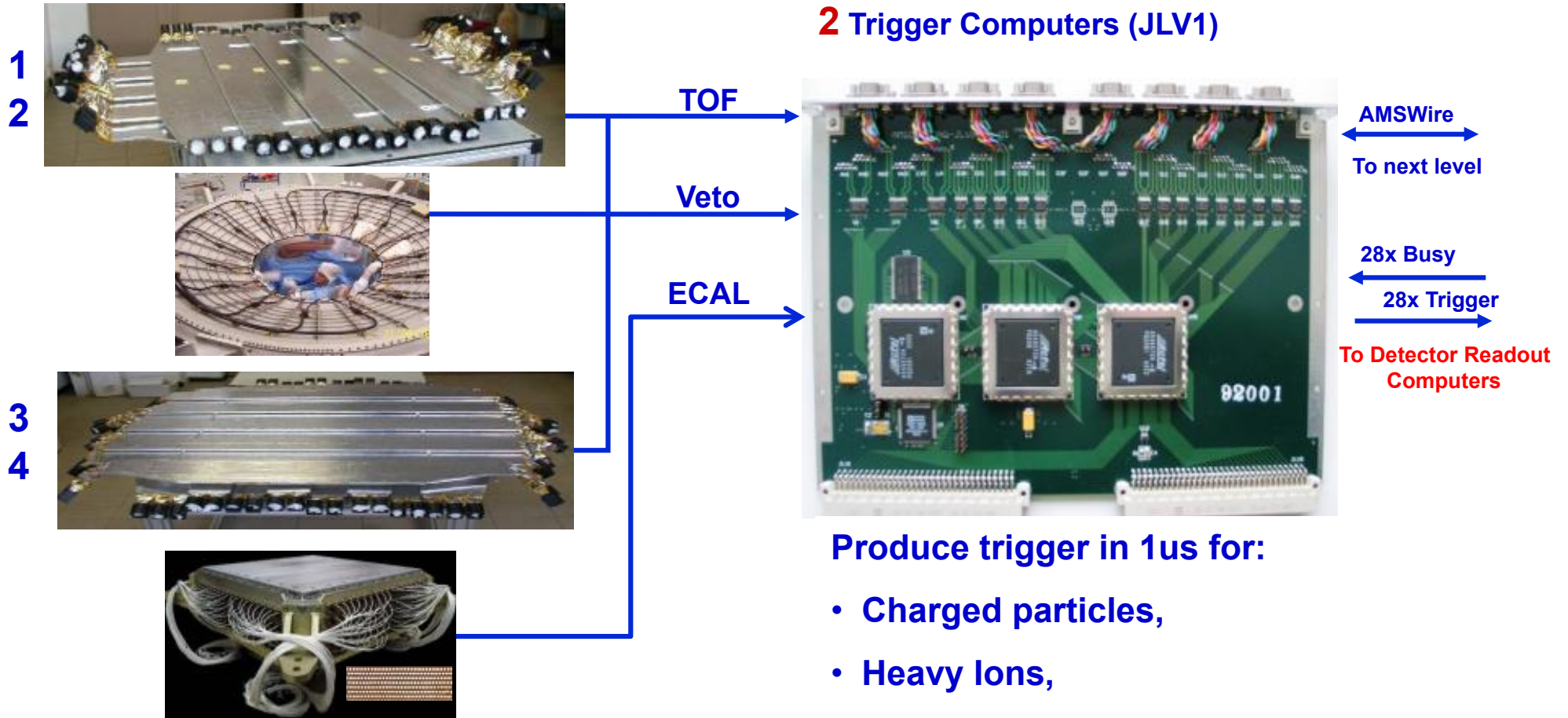

Produce trigger in 1us for:

- Charged particles,
- Heavy Ions,
- Strangelets,
- Positrons, Electrons,
- Photons
- Efficiencies.

Flight Electronics for DAQ

196,608 Pulse Heights,
216 Low Voltages,

1 Tracker Data Reduction and Readout Computers

1

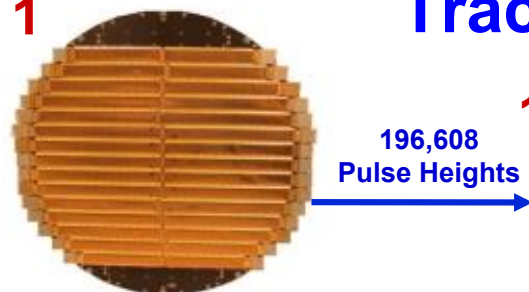

2



3



4



5



6



7



196,608
Pulse Heights

192 Tracker Data Reduction (TDR)

16 Readout Computers (JINF-T)

Low voltage

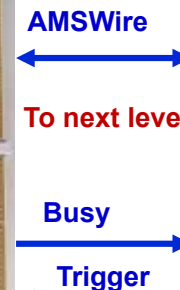

- Analog to digital conversion
coordinate resolution of 10 μm
- Data reduction:
Pedestal subtraction
Noise suppression
Cluster finding

- Collect data from TDR
- Control Low Voltages
- Combine Busy signals
- Distribute Trigger
- Distribute command to TDR



9

Flight Electronics for DAQ

ECAL Data Reduction & Trigger, Readout Computers

2,916 Pulse Heights
(high and low gain, dynodes),
346 Voltages

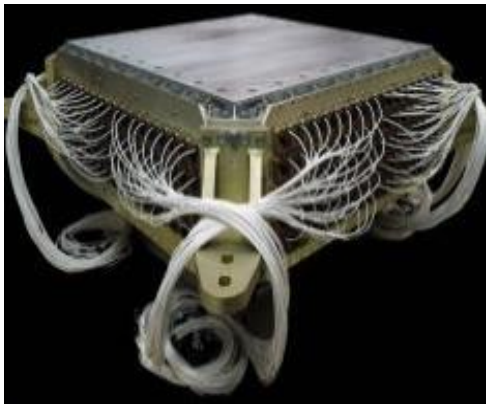

2,916
Pulse
Heights

28 ECAL Data Reduction
& Trigger Computers (EDR)

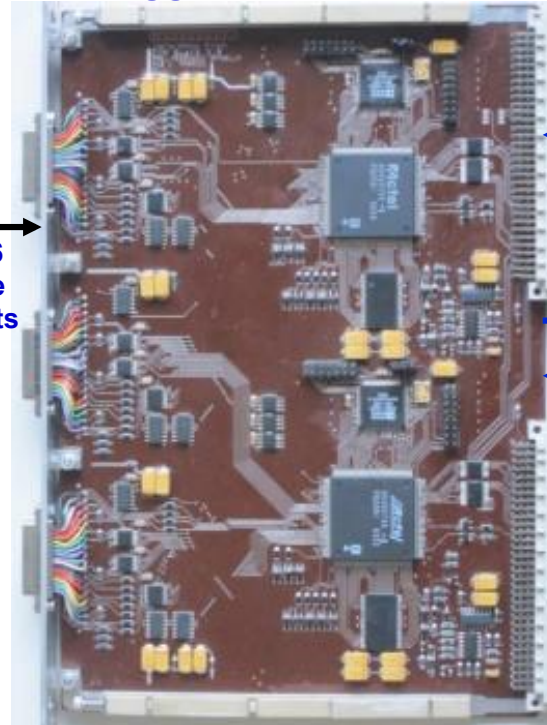

AMSWire

Busy

Trigger

4 Readout
Computers (JINF-E)

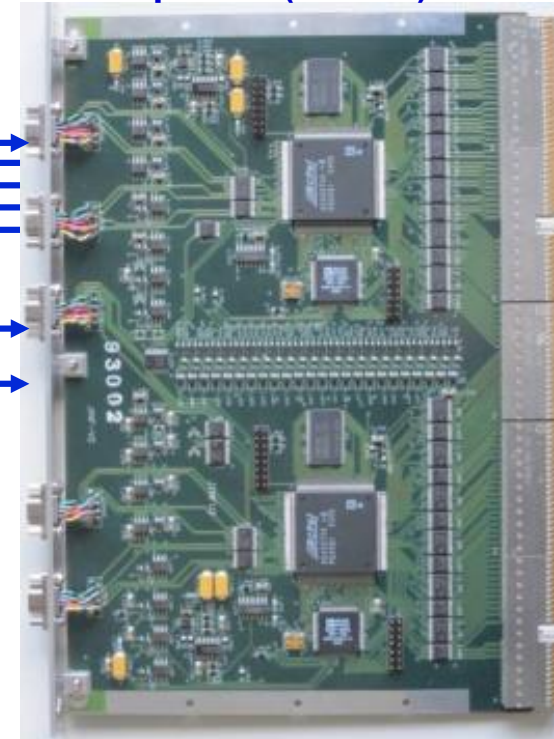

AMSWire

To next level

Busy

Trigger

High & Low Voltage Control

- Analog to digital conversion
- **Linear to 1 in 10^5**
- Produce Trigger inputs

- Collect data from EDR
- **Control High & Low Voltage**
- Combine Busy signals
- Distribute Trigger

Flight Electronics for DAQ

4 Redundant AMS Main Data Computers, each with:

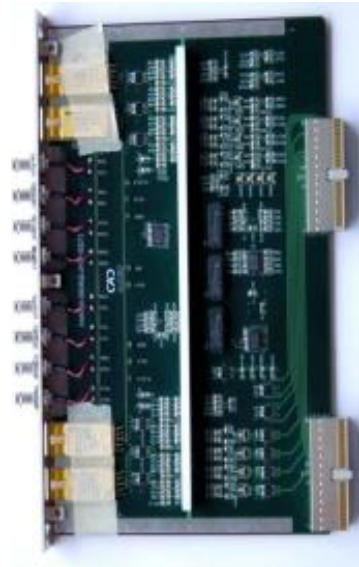

High Rate Interface



400 MHz Processor

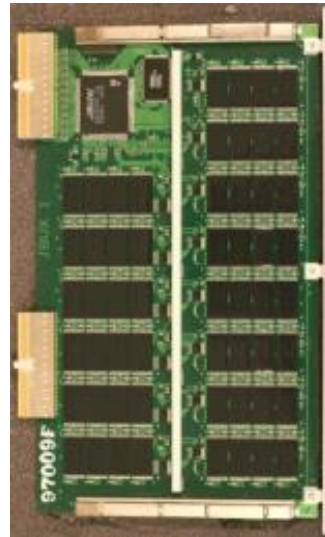

112 GB Flash Memory



CAN bus interface



AMSWire & Low Rate Interfaces

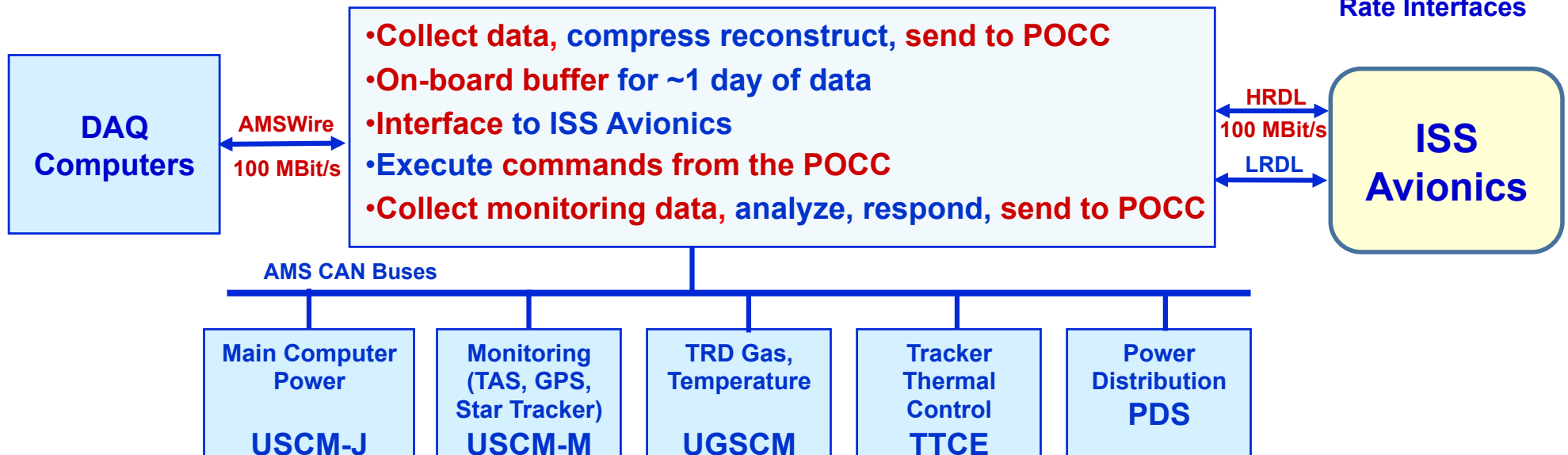

AMS Electronics

The AMS group performed extensive radiation tests to select components that tolerate the radiation of space.

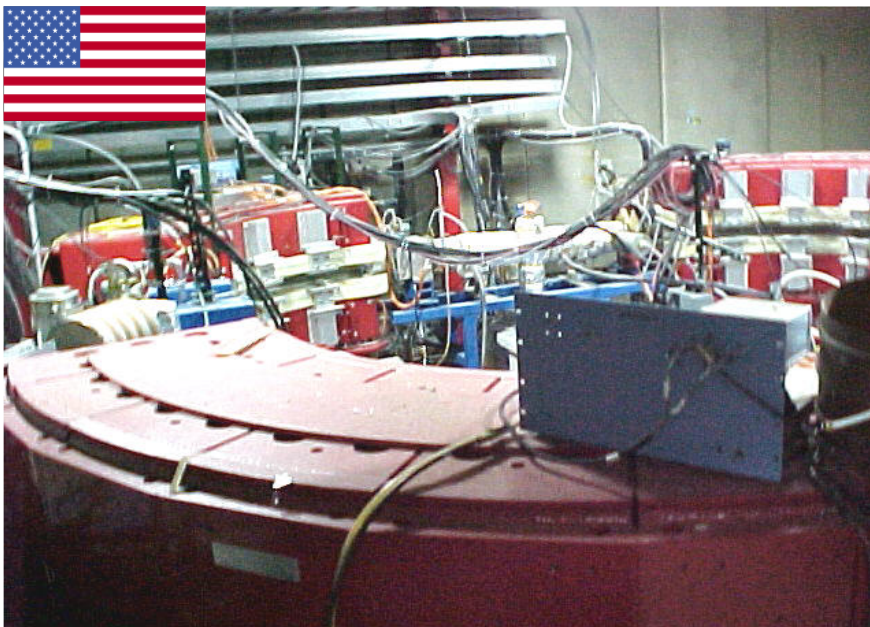



Extensive tests were made in Italy, France, Germany, Spain, Taiwan, China ... for example: in 2009: AFTER 9000 hrs of Thermal-Vacuum Tests THE END OF SUB-SYSTEMS TESTS AT SERMS



RWTH Aachen, I. Physics Institute Workshop





Space Qualification Tests of AMS in China

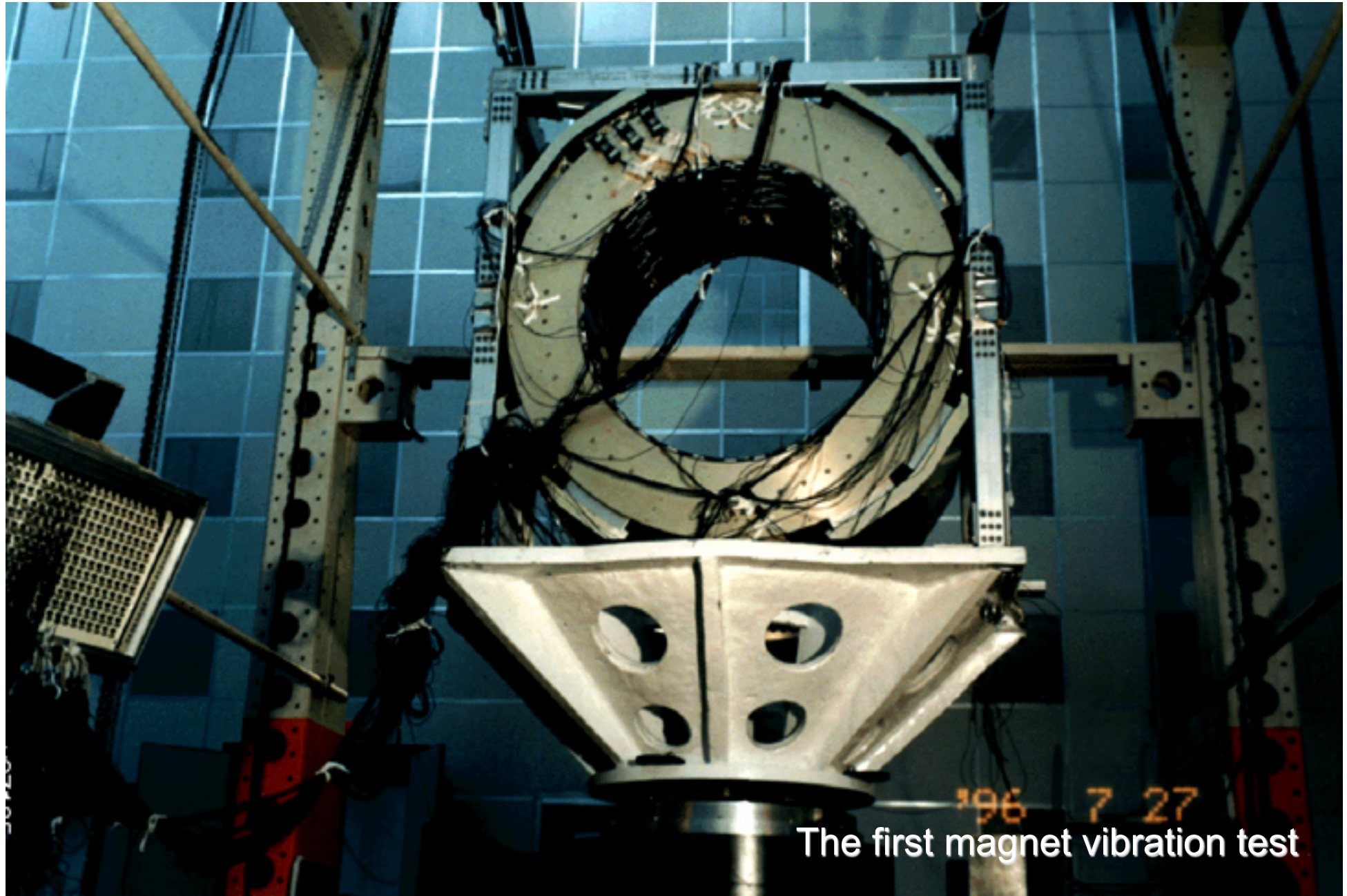

The first magnet vibration test

Space Qualification Tests of AMS in Italy (INFN)

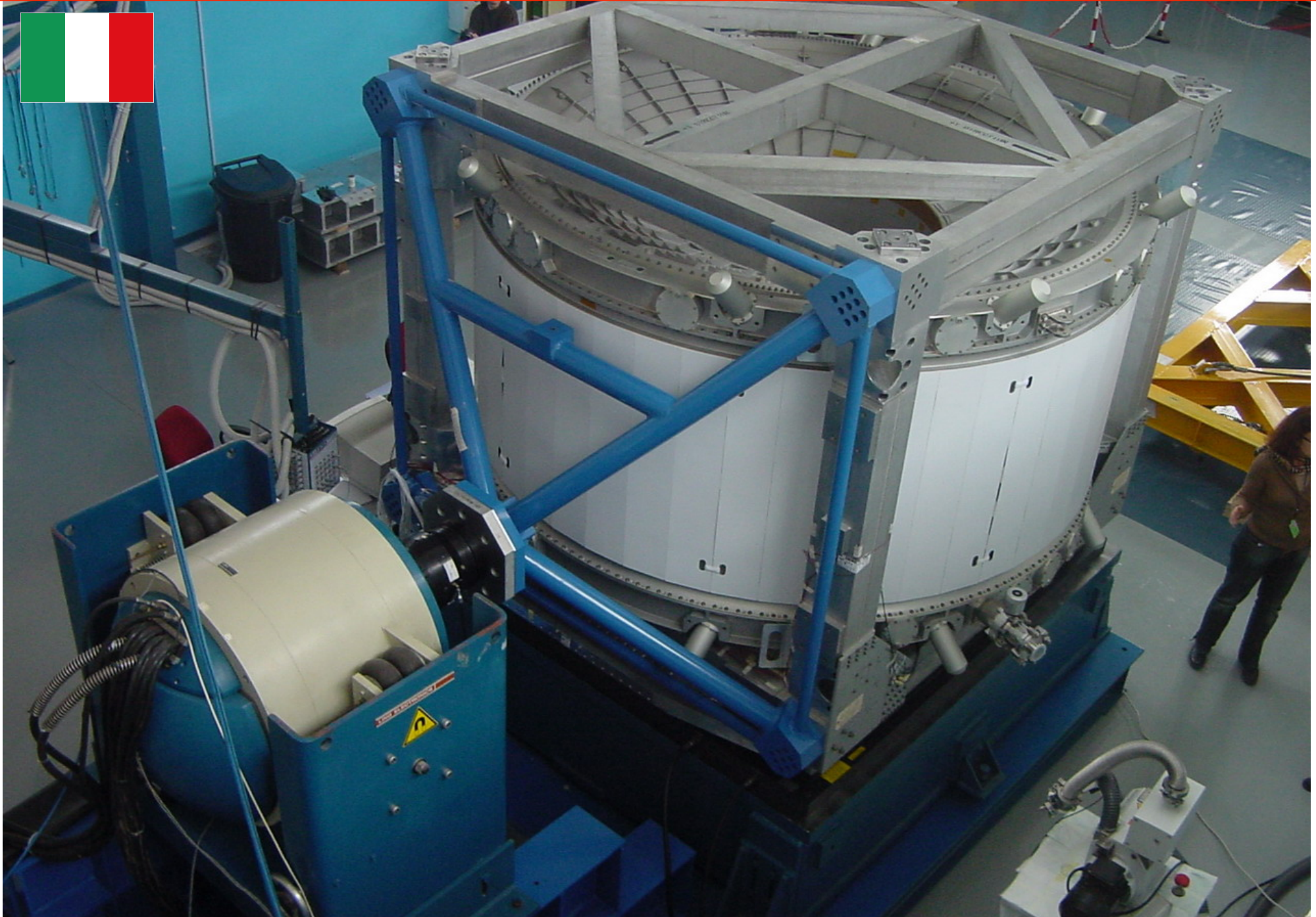

Space Qualification Tests of AMS in Germany

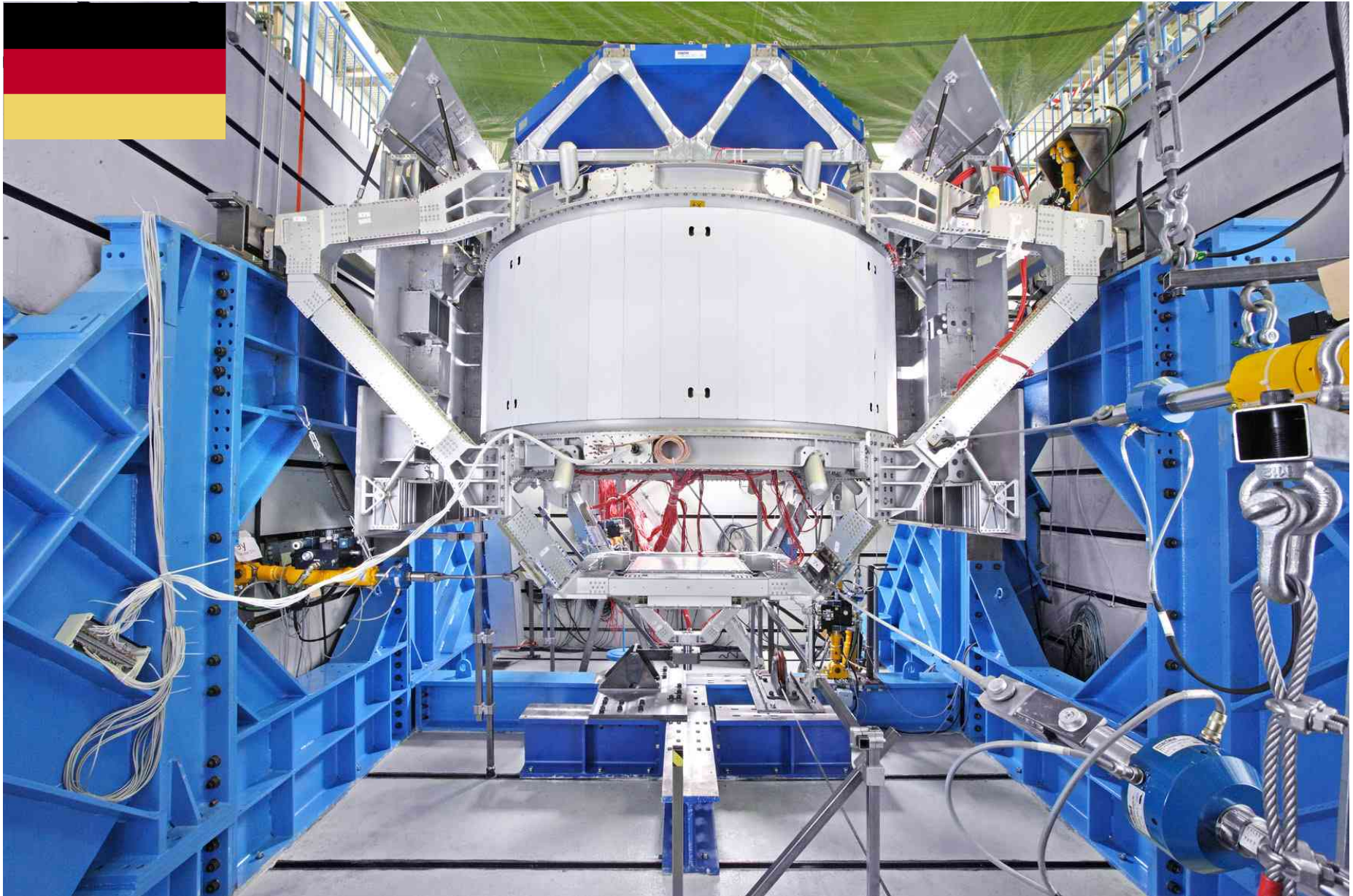

Intensive Beam Tests at CERN

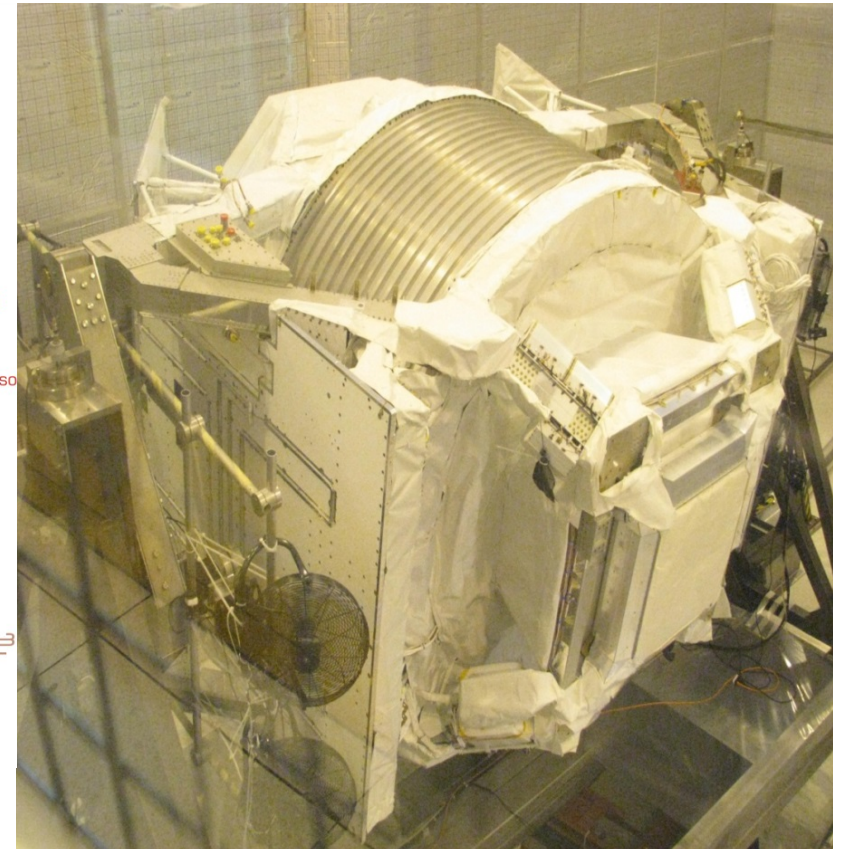
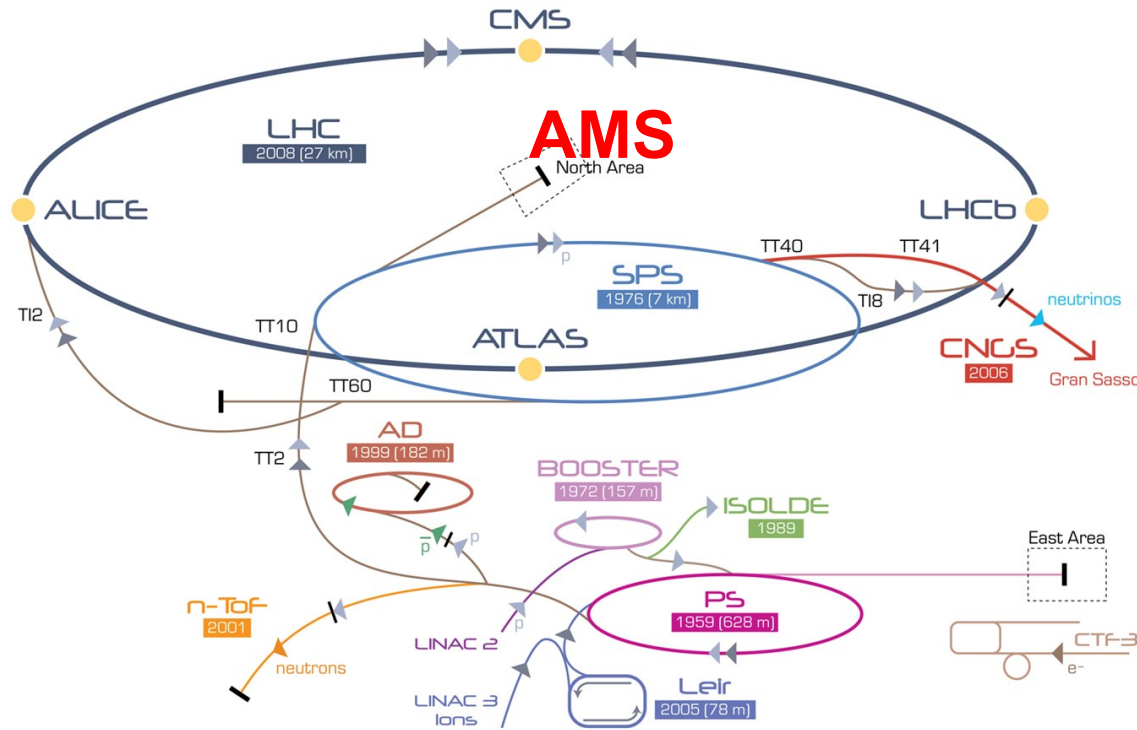

AMS in SPS Test Beam, 2010

Particle	Momentum (GeV/c)	Positions	Purpose
Protons	400 + 180	1,650	Full Tracker alignment, TOF calibration, ECAL uniformity
Electrons	100, 120, 180, 290	7 each	TRD, ECAL performance study
Positrons	10, 20, 60, 80, 120, 180	7 each	TRD, ECAL performance study
Pions	20, 60, 80, 100, 120, 180	7 each	TRD performance to 1.2 TeV



May 16th, 2011



AMS today

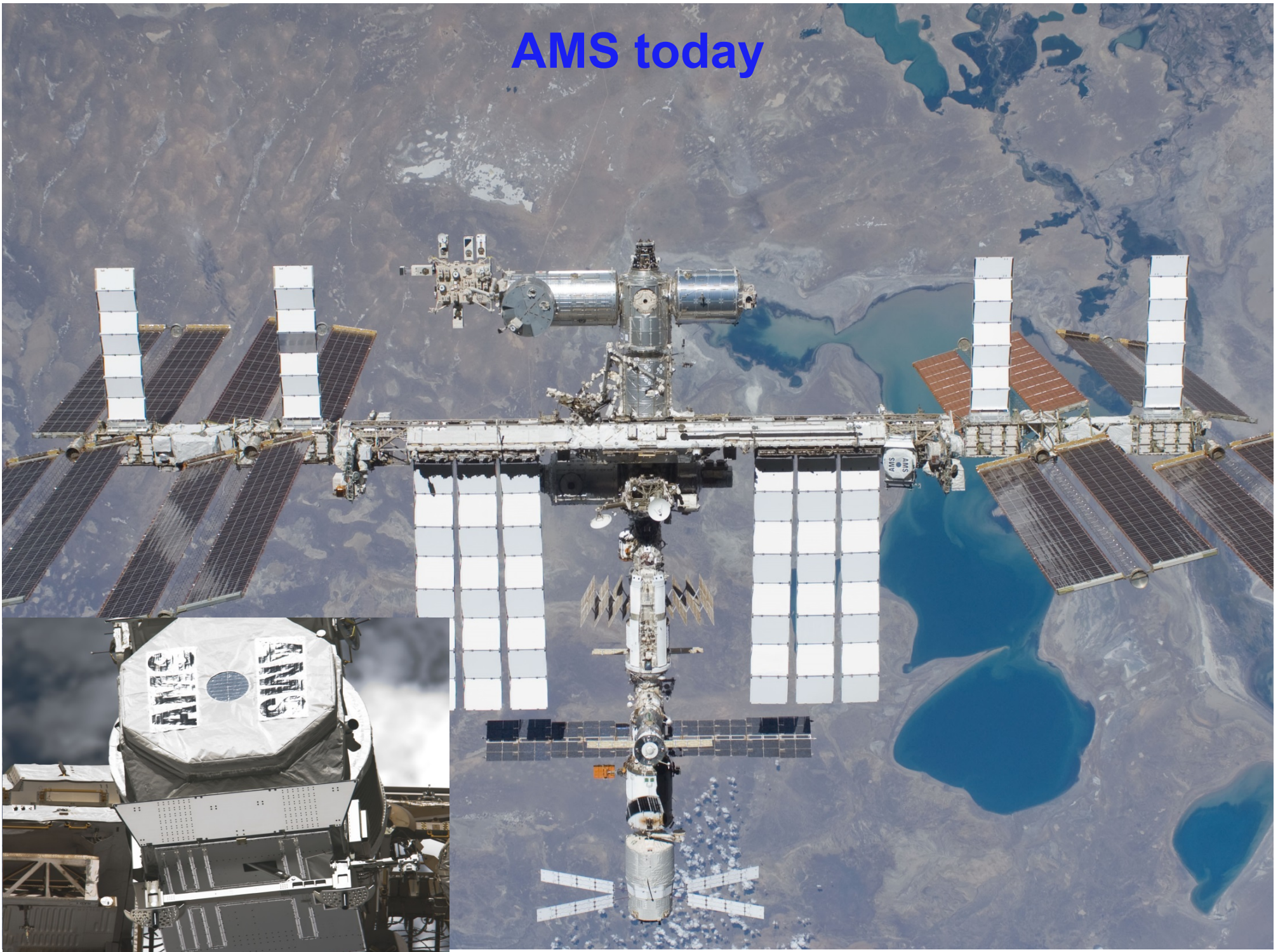

AMS Operations

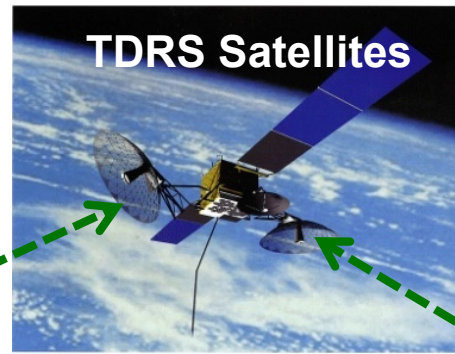

White Sands, NM



24 hours
x 365 days
x 10-20 years



Payload Operations Control
Center at CERN

AMS

Physics results

Results from the first 2 years of AMS

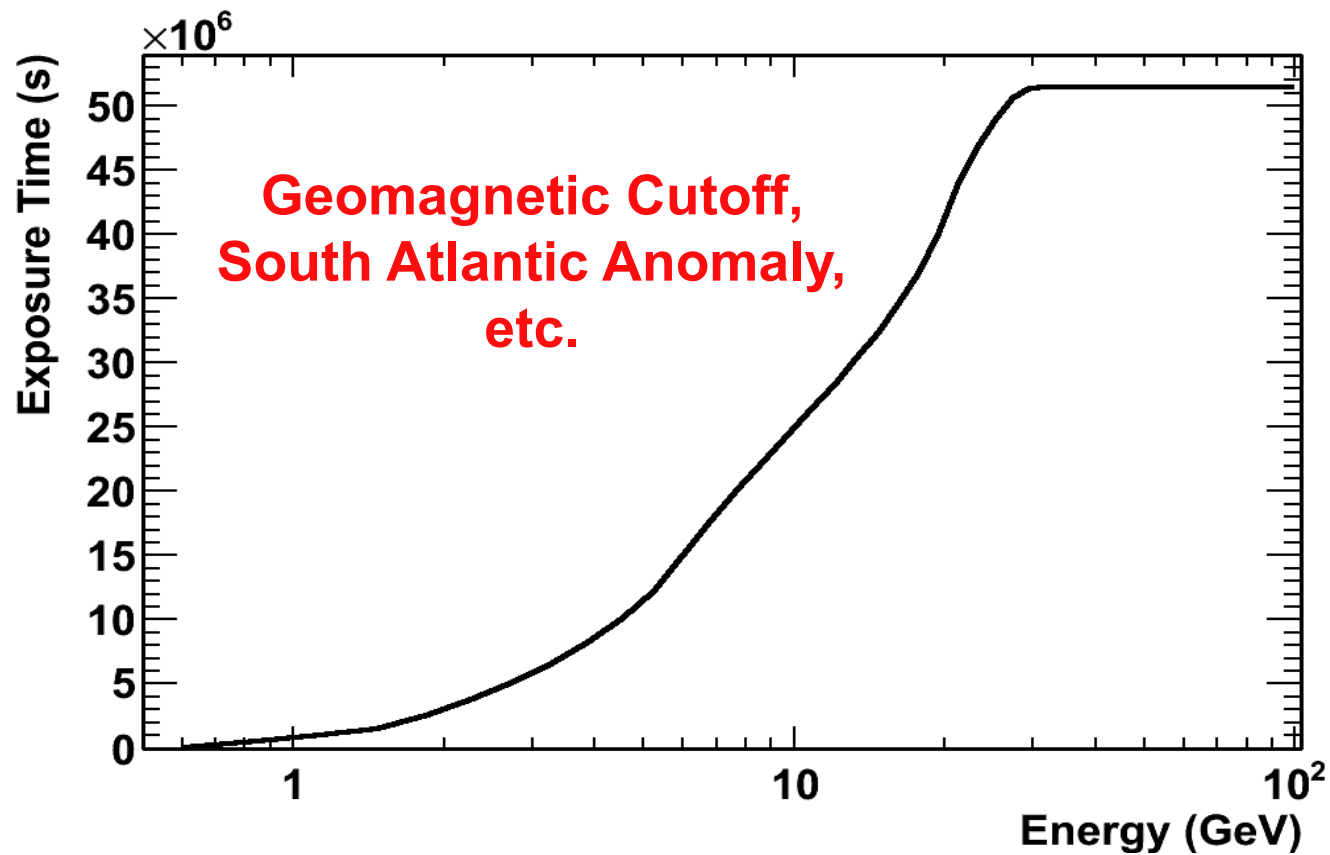

Average live time = 82 %

Data analysis in AMS (2 years of data)

AMS is a very precise particle physics detector.

Precision physics results require attention to detail and a large analysis effort.

The data are analysed by two independent AMS international teams.

Example: the positron fraction paper

Group A

Group α



B. Bertucci

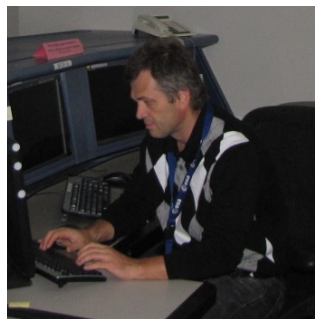

V. Choutko



A. Kounine



J. Berdugo



S. Schael



M. Incagli



S. Rosier-Lees



S. Haino, A. Oliva



J. Casaus, P. Zuccon



A. Contin

Physics results (ICRC 2013)

1. $e^+/(e^+ + e^-)$ ratio and anisotropy
2. Proton spectrum
3. Helium spectrum
4. Electron Spectrum
5. Positron Spectrum
6. All electron spectrum
7. Boron-to-Carbon ratio

Physics of Positron Fraction: $e^+ / (e^+ + e^-)$

M. Turner and F. Wilczek, Phys. Rev. D42 (1990) 1001;
J. Ellis, 26th ICRC Salt Lake City (1999) astro-ph/9911440;
H. Cheng, J. Feng and K. Matchev, Phys. Rev. Lett. 89 (2002) 211301;
S. Profumo and P. Ullio, J. Cosmology Astroparticle Phys. JCAP07 (2004) 006;
D. Hooper and J. Silk, Phys. Rev. D 71 (2005) 083503;
E. Ponton and L. Randall, JHEP 0904 (2009) 080;
G. Kane, R. Lu and S. Watson, Phys. Lett. B681 (2009) 151;
D. Hooper, P. Blasi and P. D. Serpico, JCAP 0901 025 (2009) 0810.1527; B2
Y-Z. Fan et al., Int. J. Mod. Phys. D19 (2010) 2011;
M. Pato, M. Lattanzi and G. Bertone, JCAP 1012 (2010) 020.

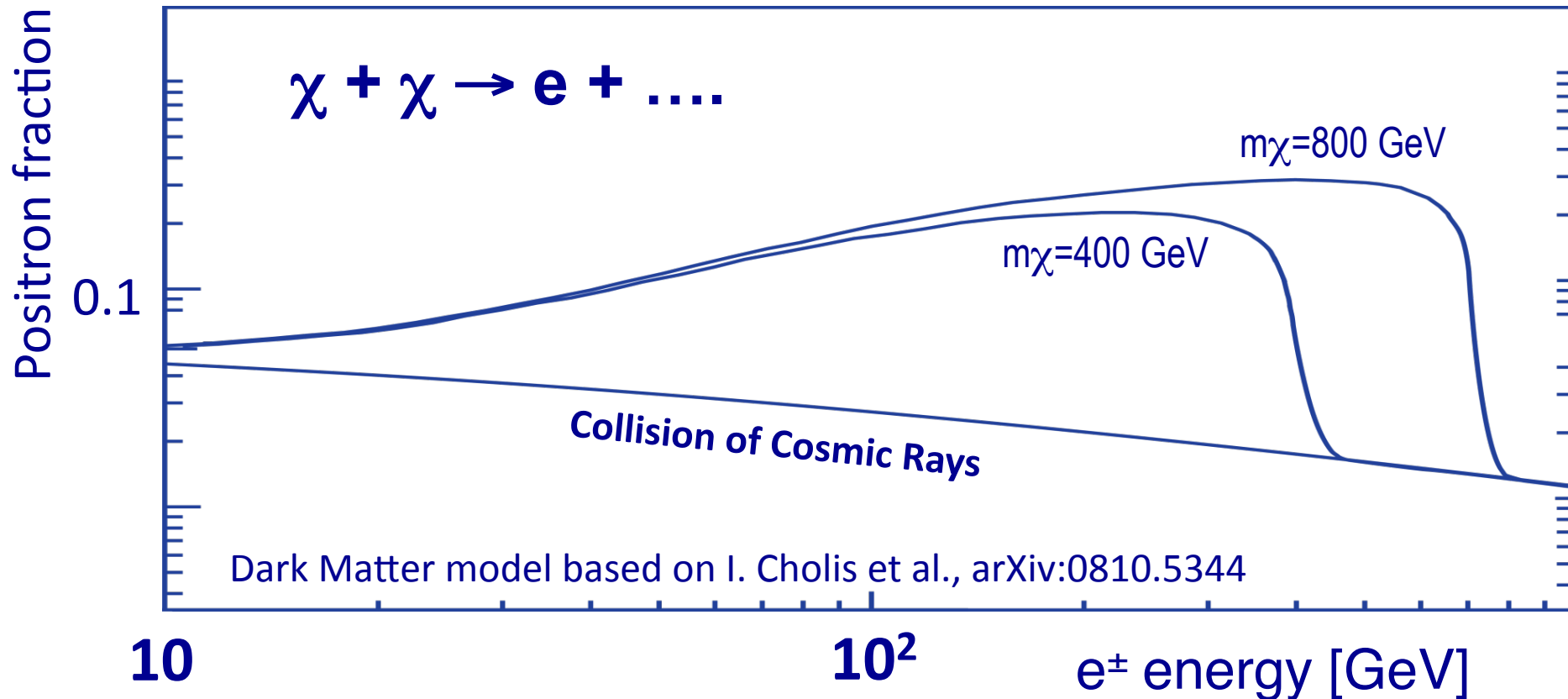

In the first 1.5 years in space, AMS has collected over 25 billion events.
6.8 million are electrons or positrons.

Electron E=982 GeV
Run/Event 1329775818/ 60709

Positron E=636 GeV
Run/Event 133119-743/ 56950

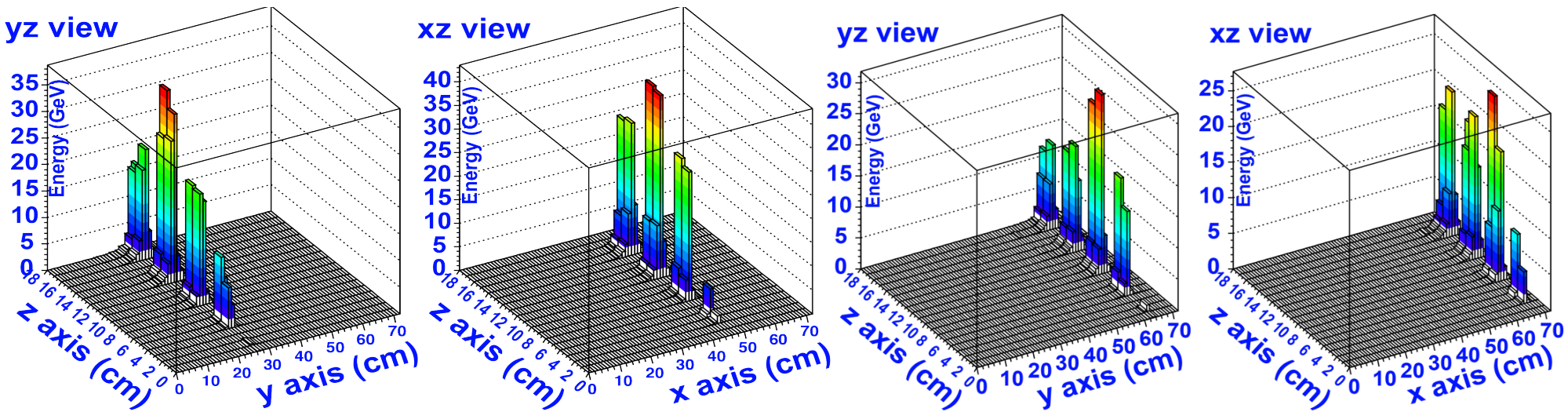
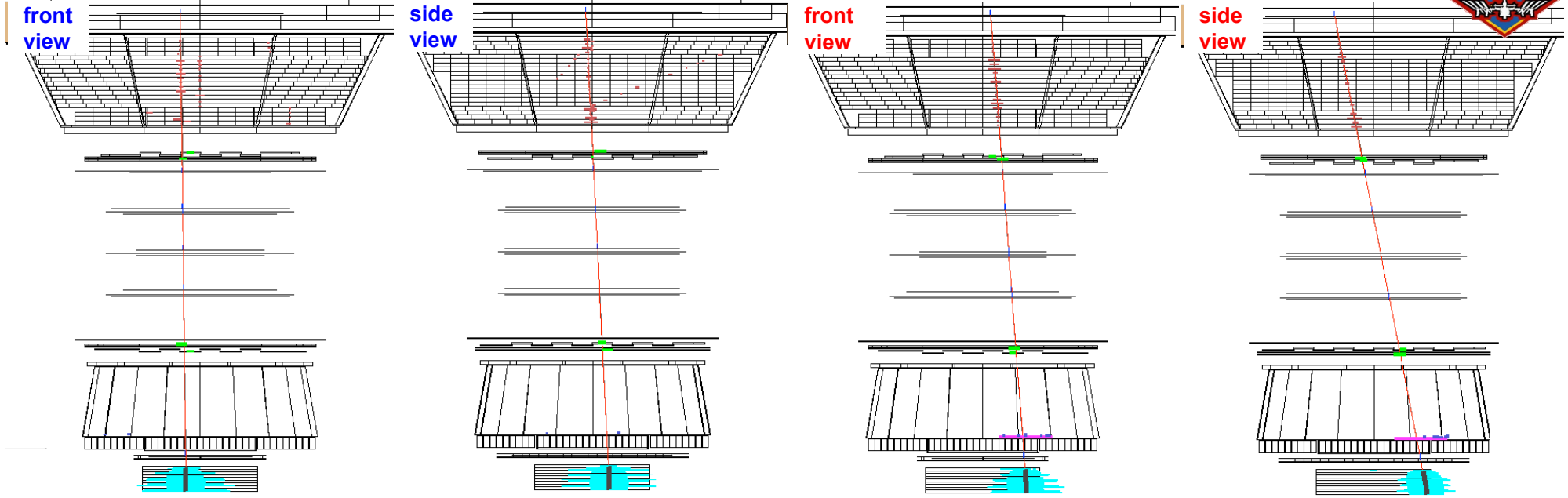

TRD performance on ISS

$$\text{TRD estimator} = -\ln(P_e/(P_e+P_p))$$

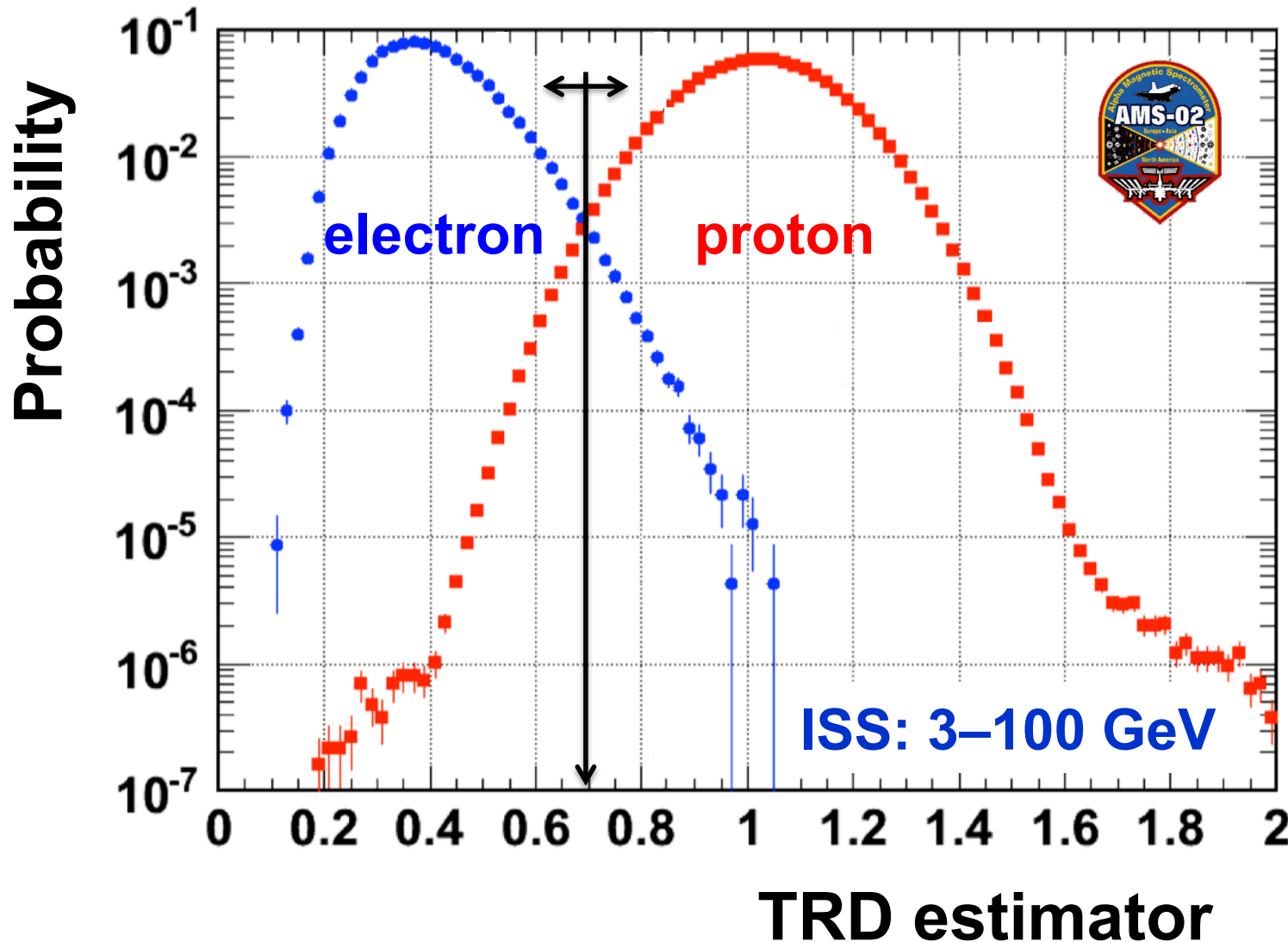

Normalized probabilities
 P_e and P_p

$$P_e = \sqrt[n]{\prod_i^n P_e^{(i)}(A)}$$
$$P_p = \sqrt[n]{\prod_i^n P_p^{(i)}(A)}$$

TRD performance on ISS

Proton rejection at 90% e^+ efficiency

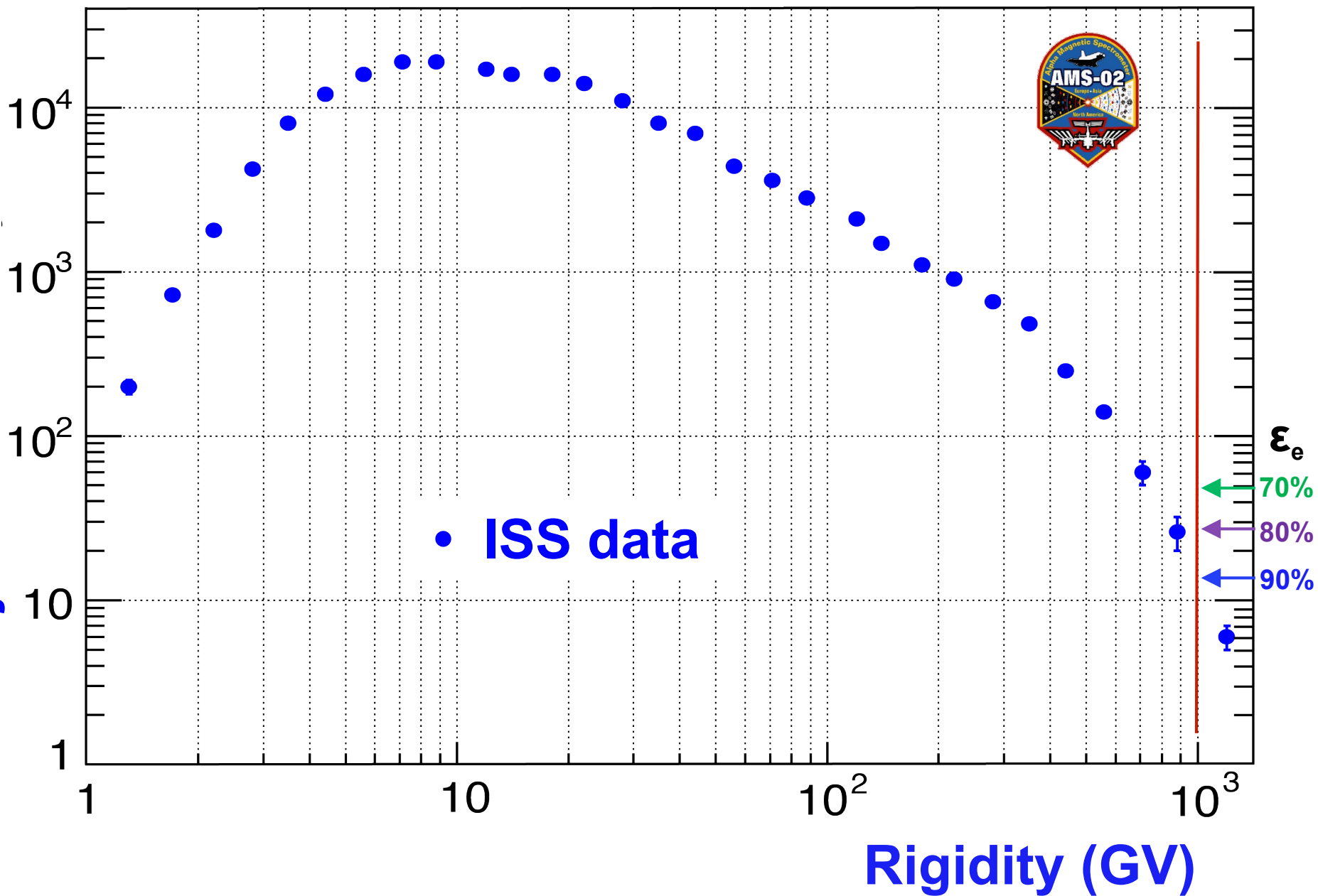

Results of the fit:

The TRD Estimator shows clear separation between **protons** and positrons with a small **charge confusion** background

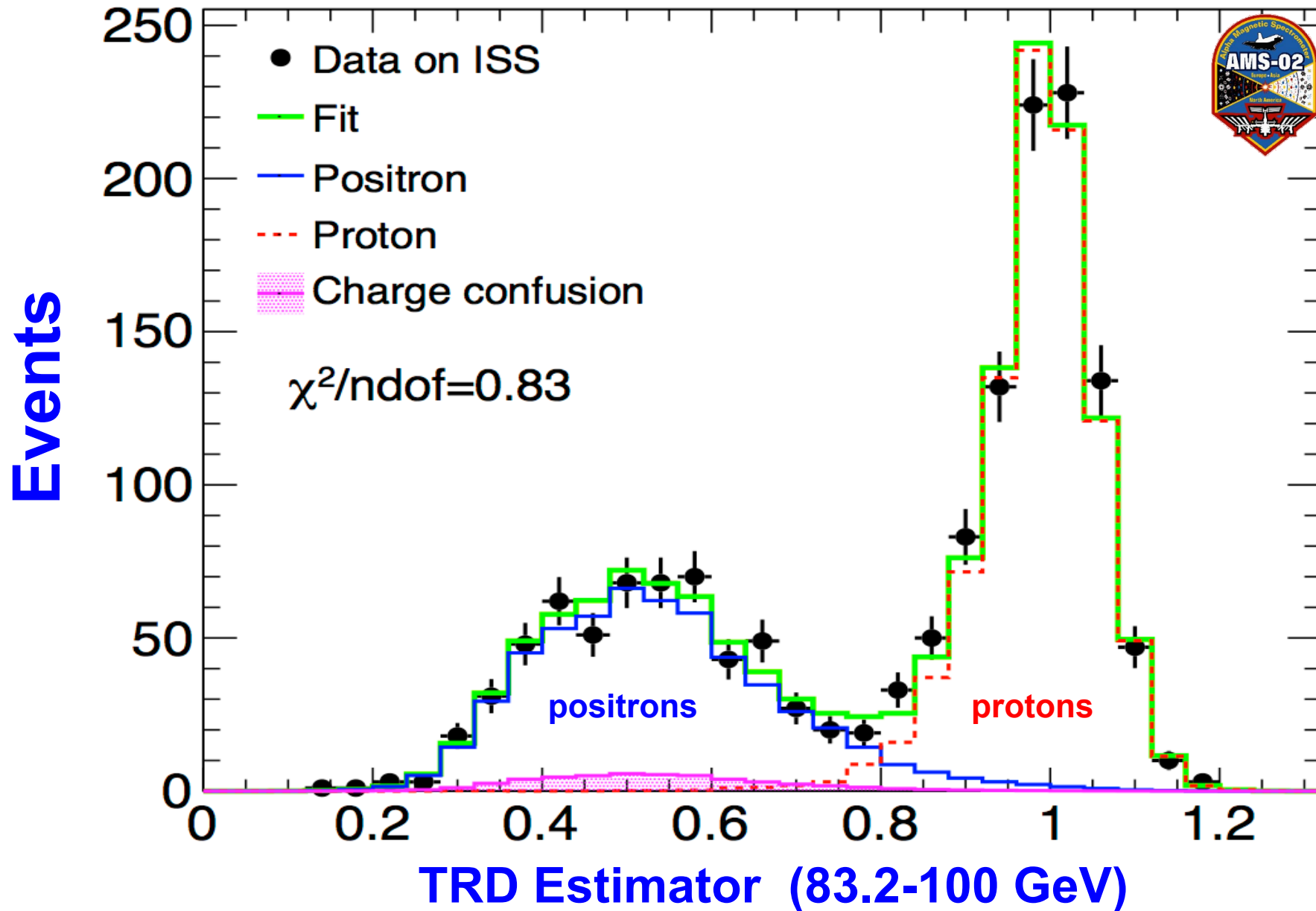

Separation of protons and electrons with ECAL

ISS data: 83–100 GeV

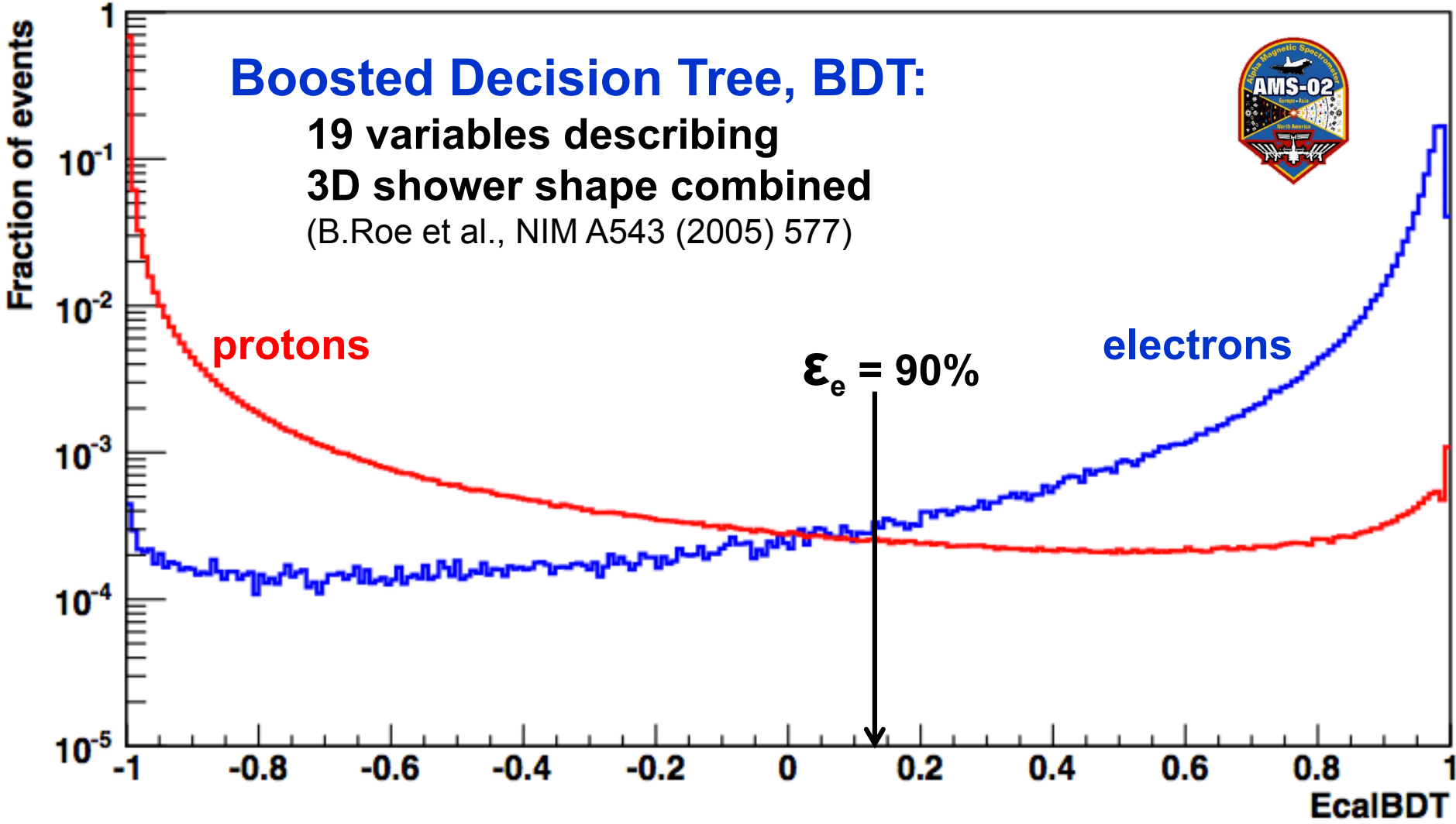

Data from ISS: Proton rejection using the ECAL

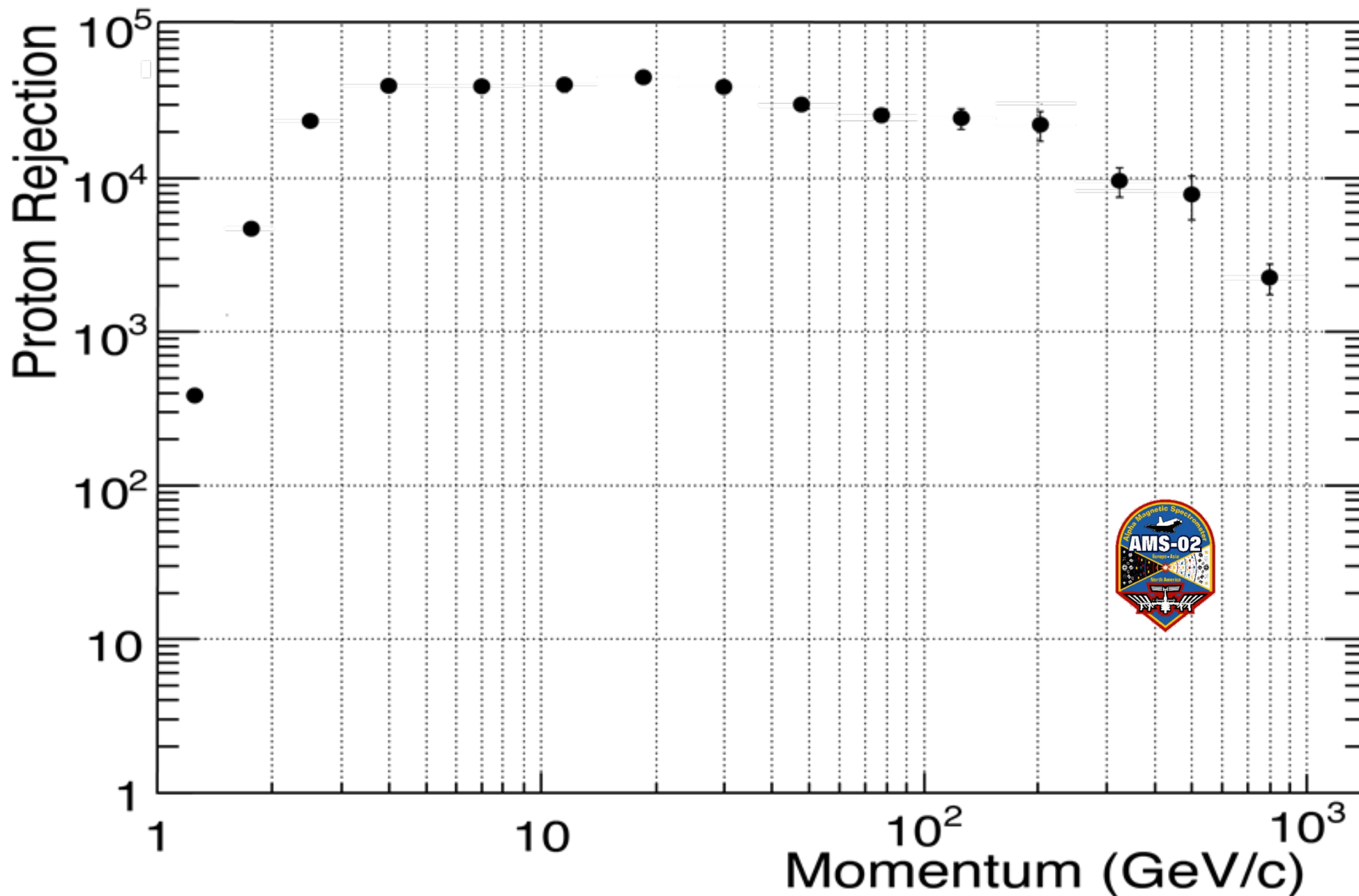

Systematic error on the positron fraction: e^{+/-} Charge confusion

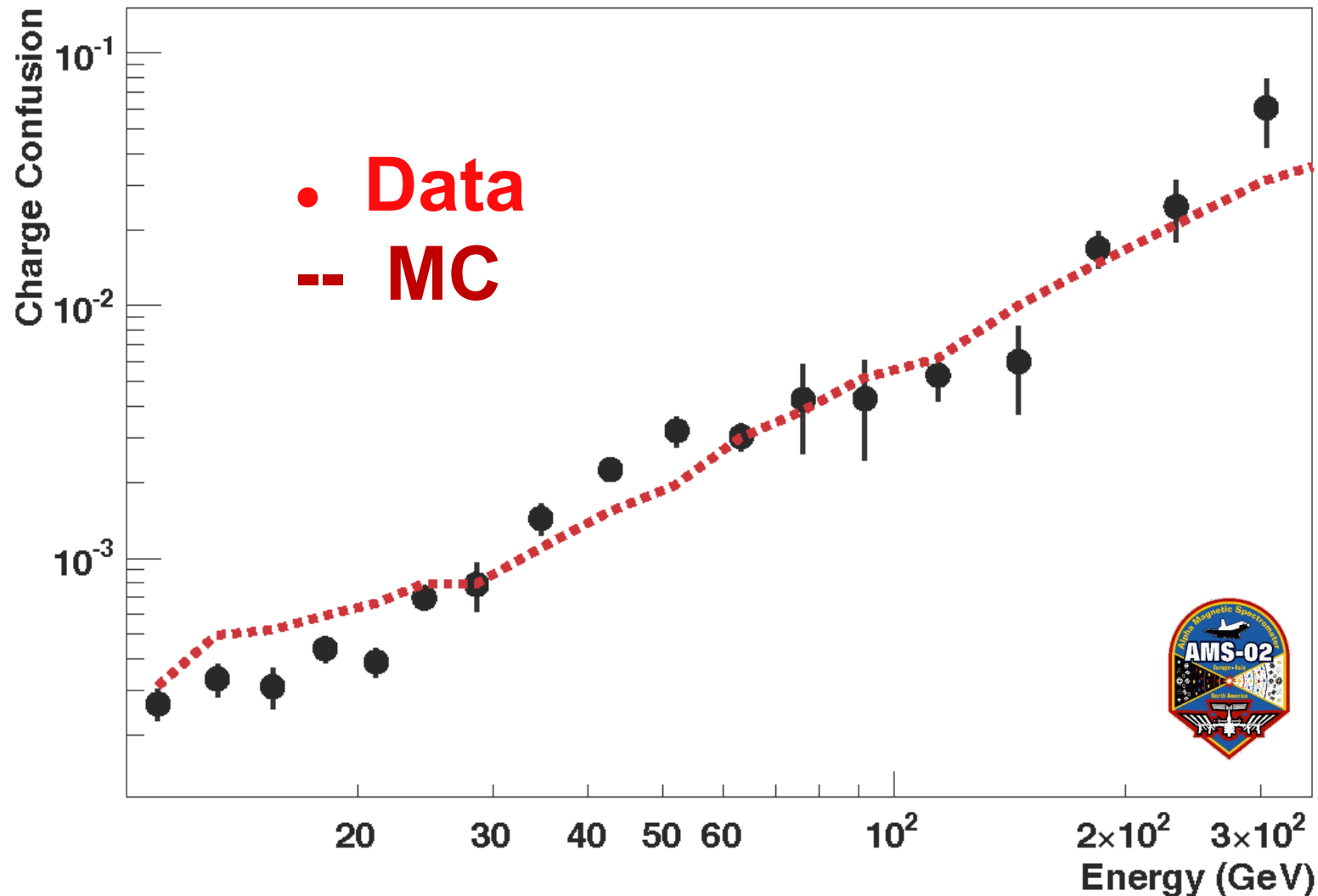

Two sources: large angle scattering and production of secondary tracks along the path of the primary track. Both are well reproduced by MC. Systematic errors correspond to variations of these effects within their statistical limits.

“First Result from the AMS on the ISS: Precision Measurement of the Positron Fraction in Primary Cosmic Rays of 0.5-350 GeV”

Selected for a
Viewpoint in Physics and
an Editors' Suggestion
[Aguilar, M. et al (AMS
Collaboration) Phys. Rev.
Lett. 110, 1411xx (2013)]

PHYSICAL REVIEW LETTERS™

Member Subscription Copy
Library or Other Institutional Use Prohibited Until 2017

Articles published week ending 5 APRIL 2013

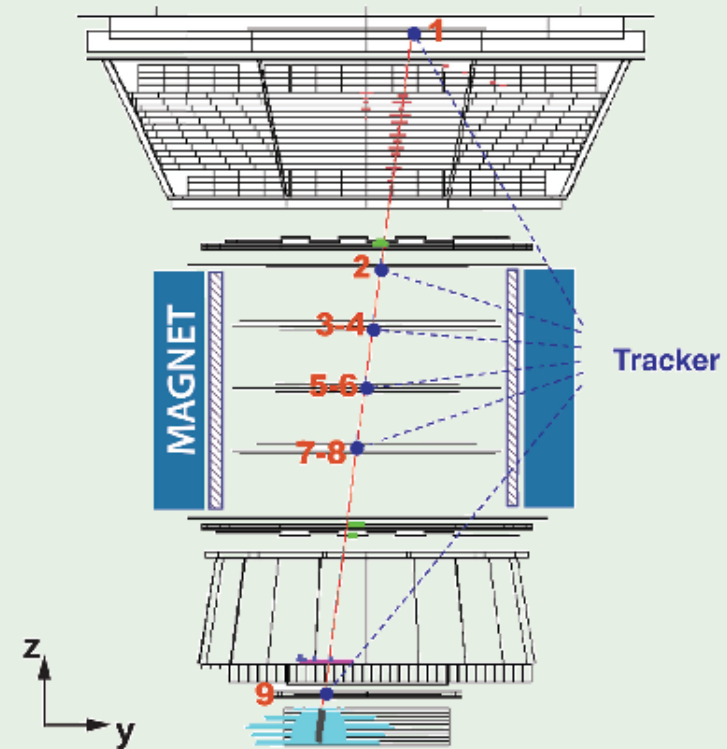

Published by
American Physical Society.



Volume 110, Number 14



AMS-02 (6.8 million e^+ , e^- events)

The positron fraction is steadily increasing from 10 to ~250 GeV
From 20 to 250 GeV, the slope decreases by an order of magnitude
No structure in the spectrum

Positron fraction

10^{-1}

1

10

10^2

positron, electron energy [GeV]

- AMS
- △ FERMI
- PAMELA
- AMS-01
- HEAT
- ▽ CAPRICE98
- ▲ CAPRICE94
- TS93

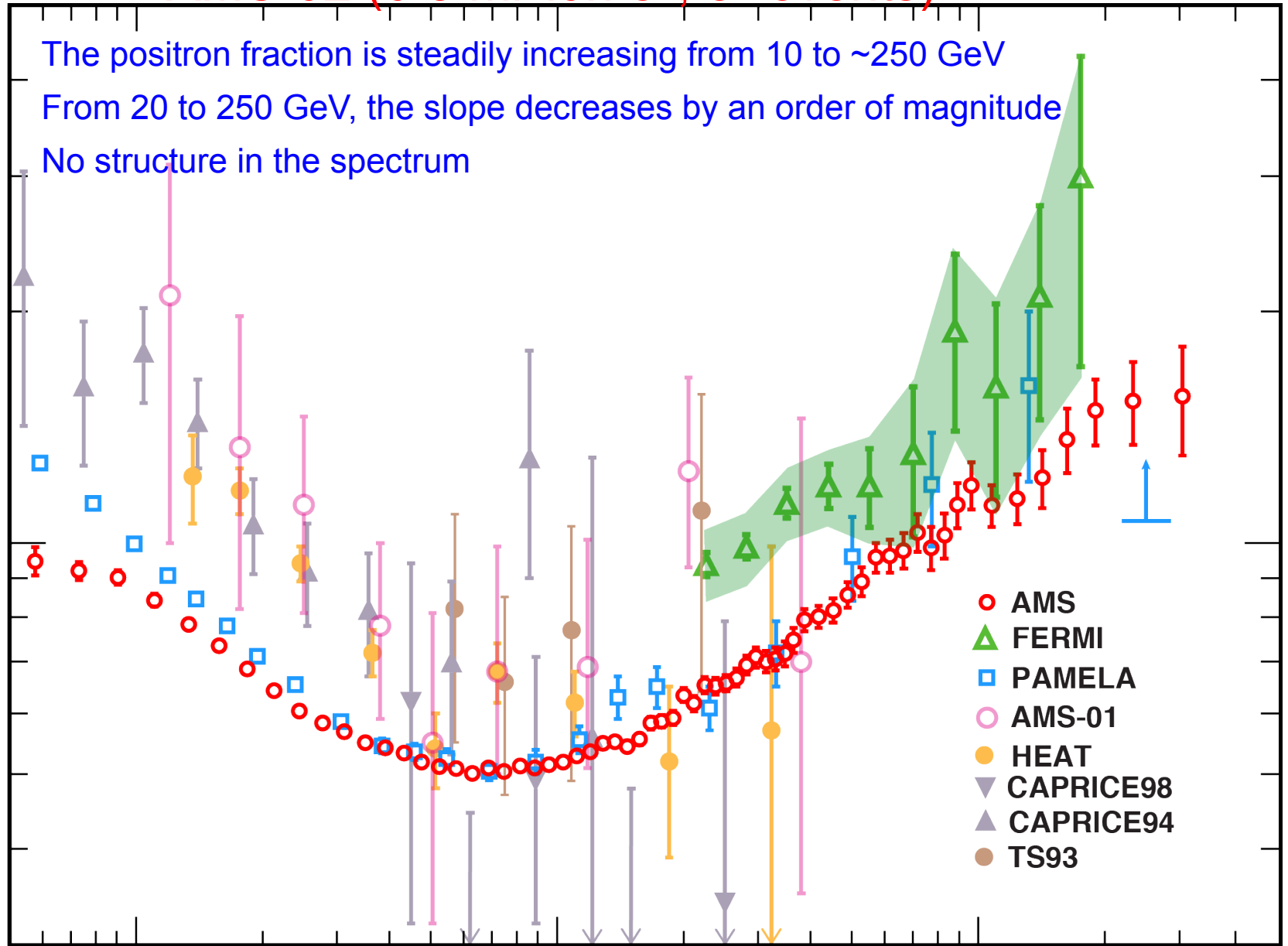

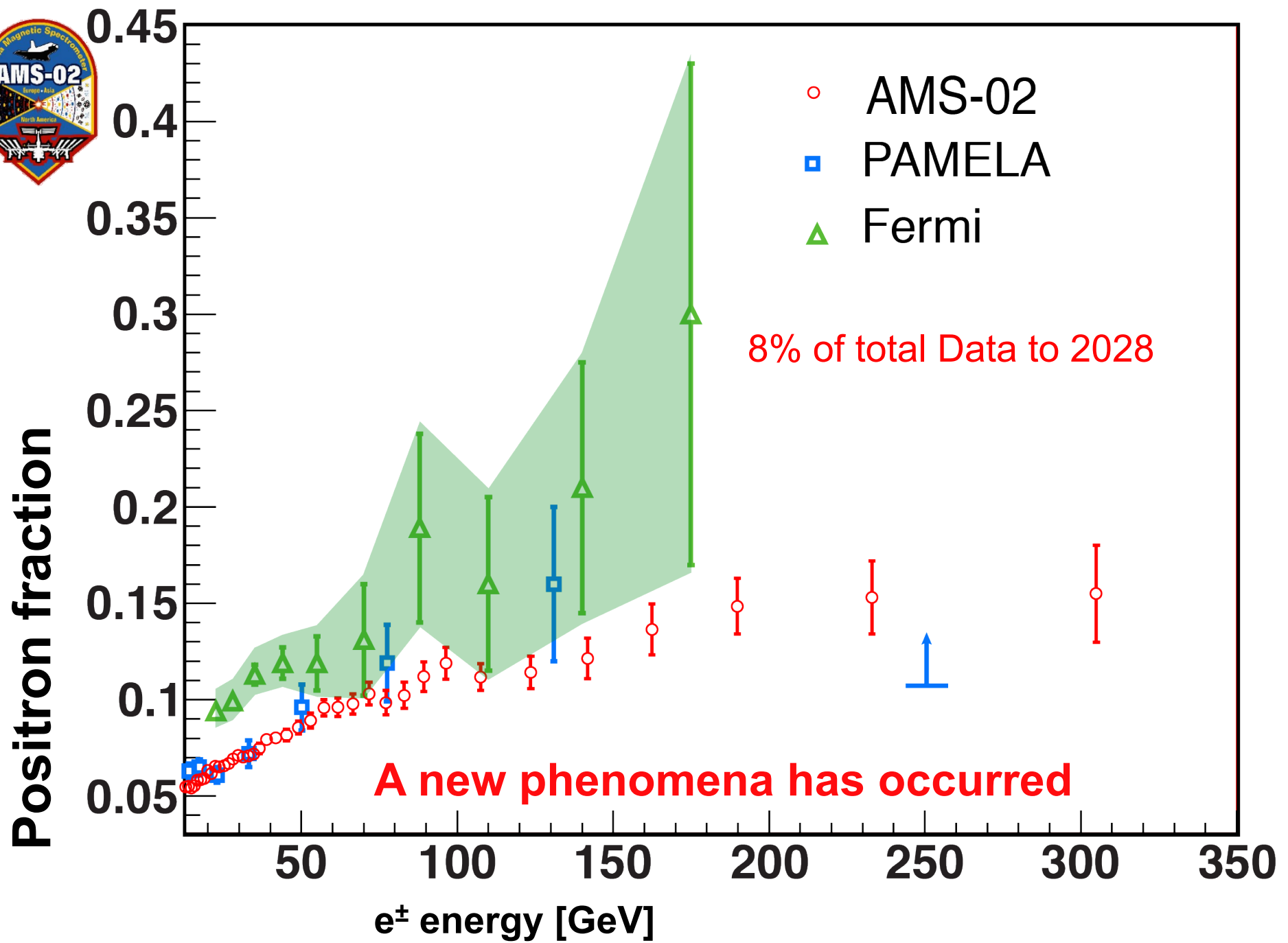

To be presented by A. Kounine (8 July 14:30, ICRC-1264)

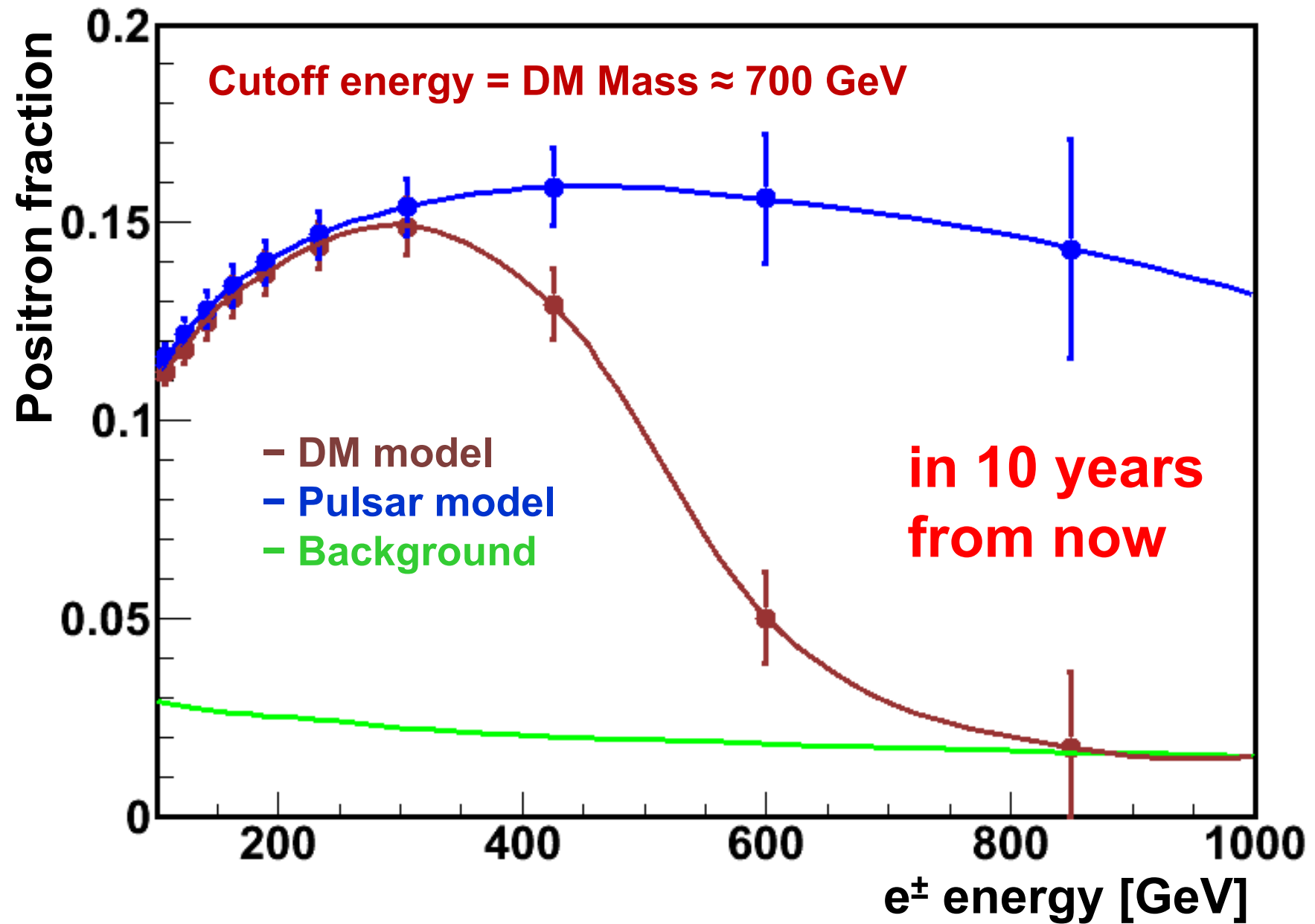

What will the Positron Fraction look like at high energy?

Comparison of \bar{p}/p Results with Models in 10 more years

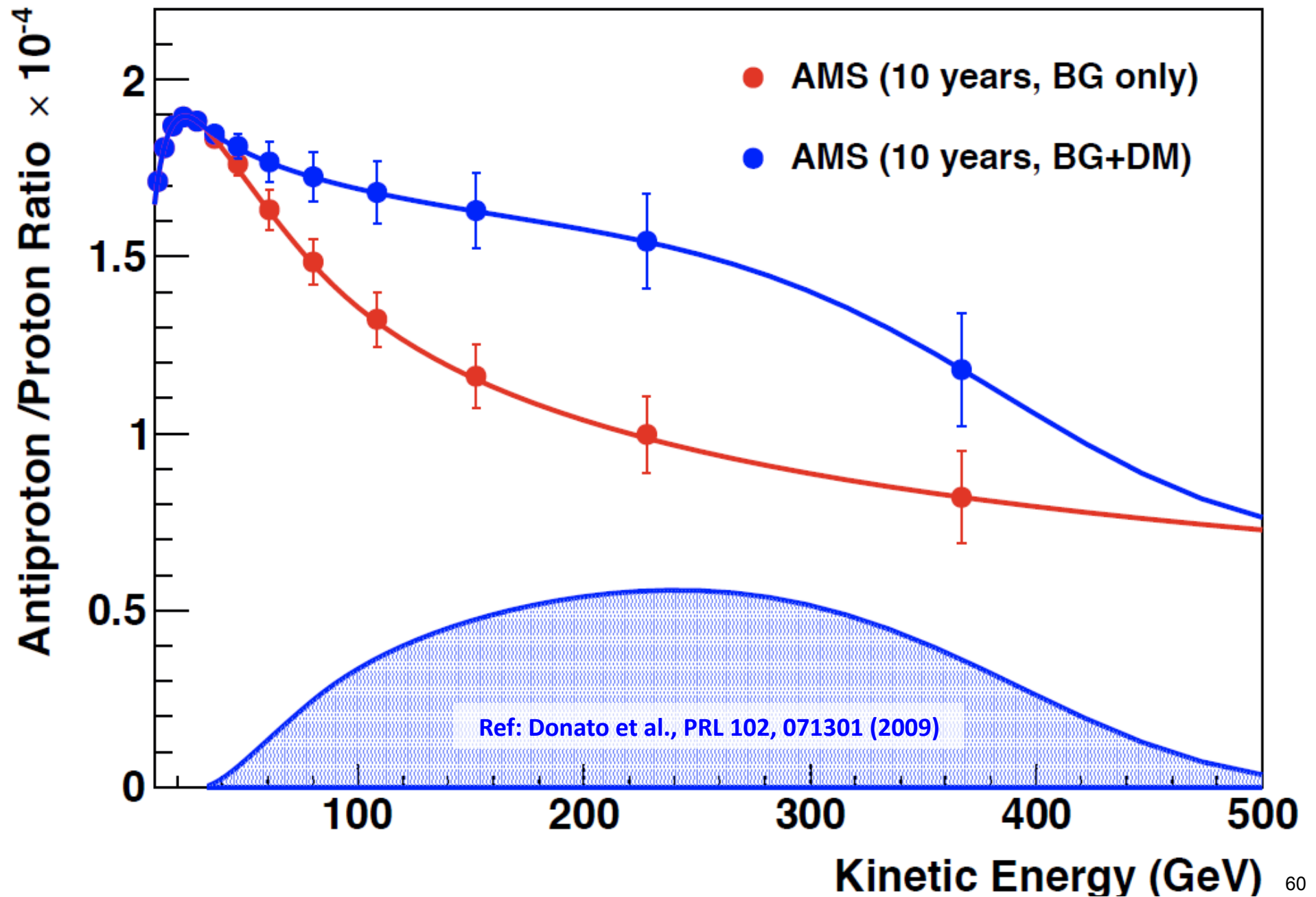

Selected events are grouped into
5 cumulative energy bins:
16-350, 25-350, 40-350, 65-350
and 100-350 GeV.

Their arrival
directions are used to
build sky maps in
galactic coordinates,
(b, l), containing the
number of observed
positrons and
electrons

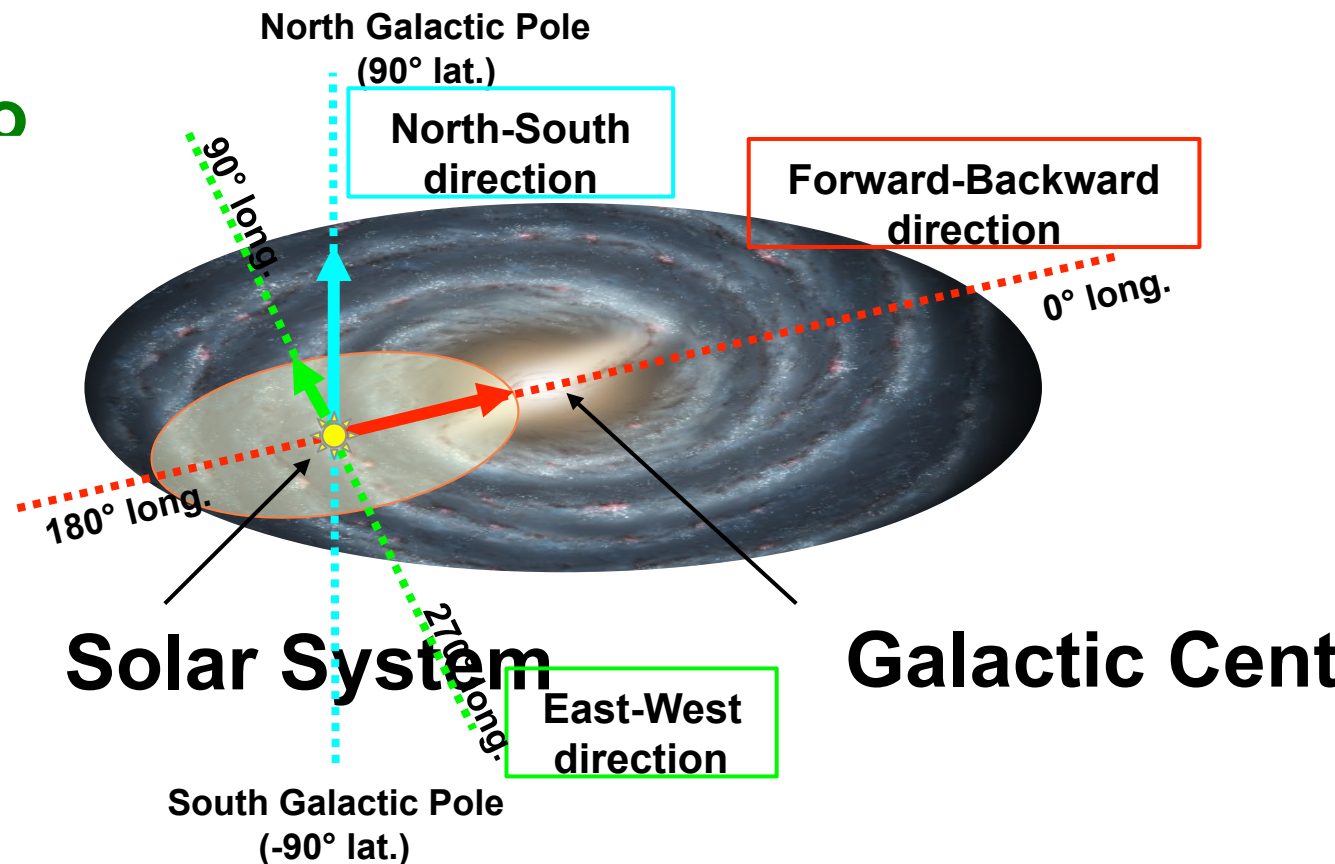



The relative fluctuations of the positron ratio, e^+/e^- , across the observed sky map show no evident pattern

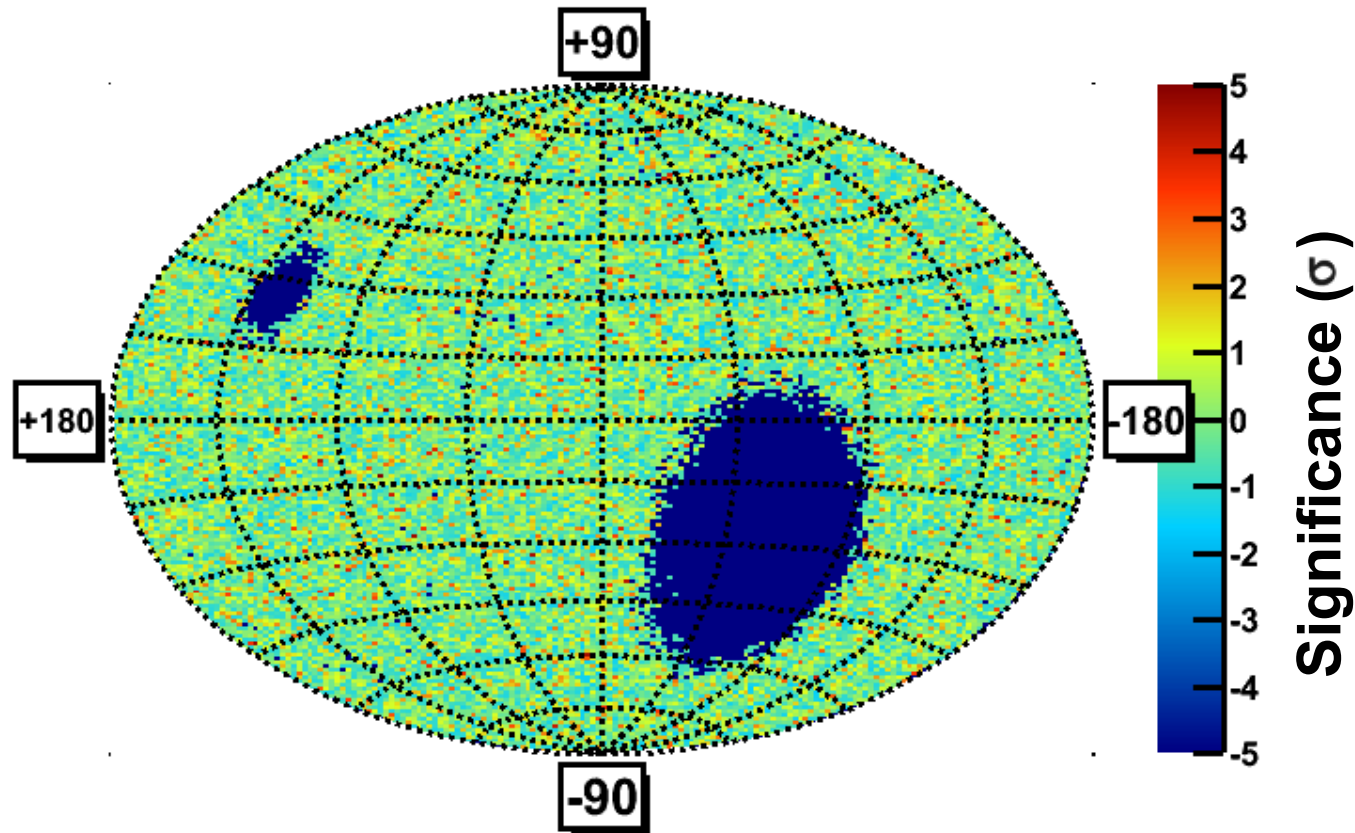



The relative fluctuations of the positron ratio, e^+/e^- , are described by means of a spherical harmonic expansion

$$\frac{r_e(\mathbf{b}, l) - \langle r_e \rangle}{\langle r_e \rangle} = \sum_{l=0}^{\infty} \sum_{m=-l}^l a_{lm} Y_{lm}(\pi/2 - \mathbf{b}, l)$$

Where

$r_e(\mathbf{b}, l)$: denotes the positron ratio at (b, l) ,

$\langle r_e \rangle$: is the average ratio over the sky map,

Y_{lm} : are the real spherical harmonic functions,

a_{lm} : are their corresponding amplitudes



The amplitudes of spherical harmonic contributions at fixed angular scale, l are fit to data for **dipole** ($l=1$), **quadrupole** ($l=2$) and **octopole** ($l=3$)

The fit amplitudes, a_{lm} , are found to be consistent with the hypothesis of isotropy at all energies and angular scales



Dipole amplitude a_{1-1}

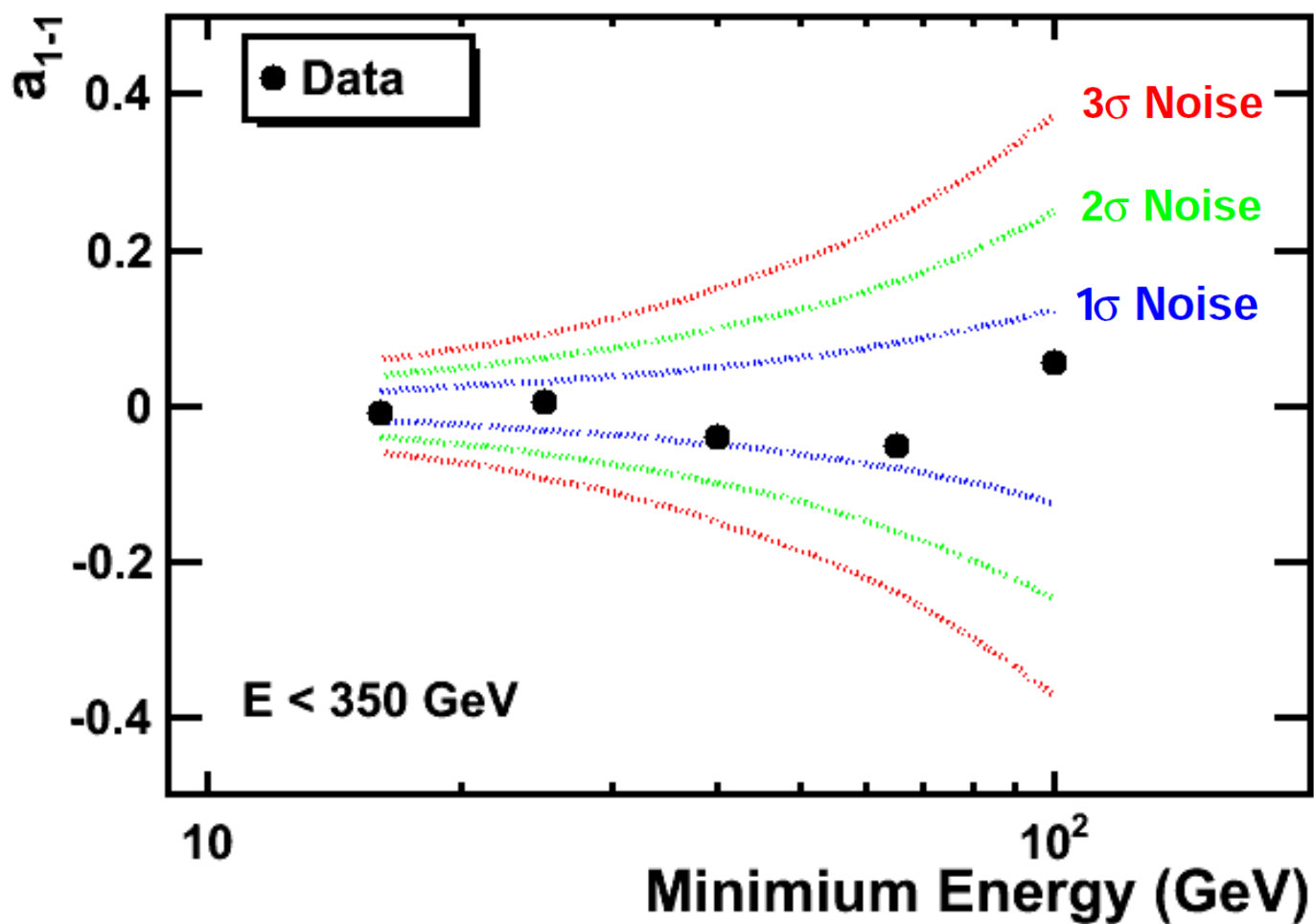
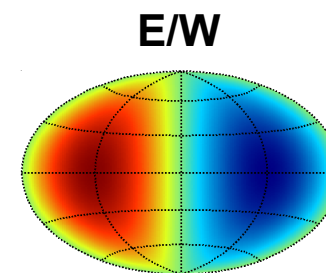



N/S

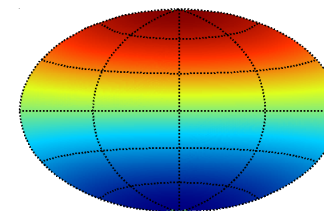

Dipole amplitude a_{10}

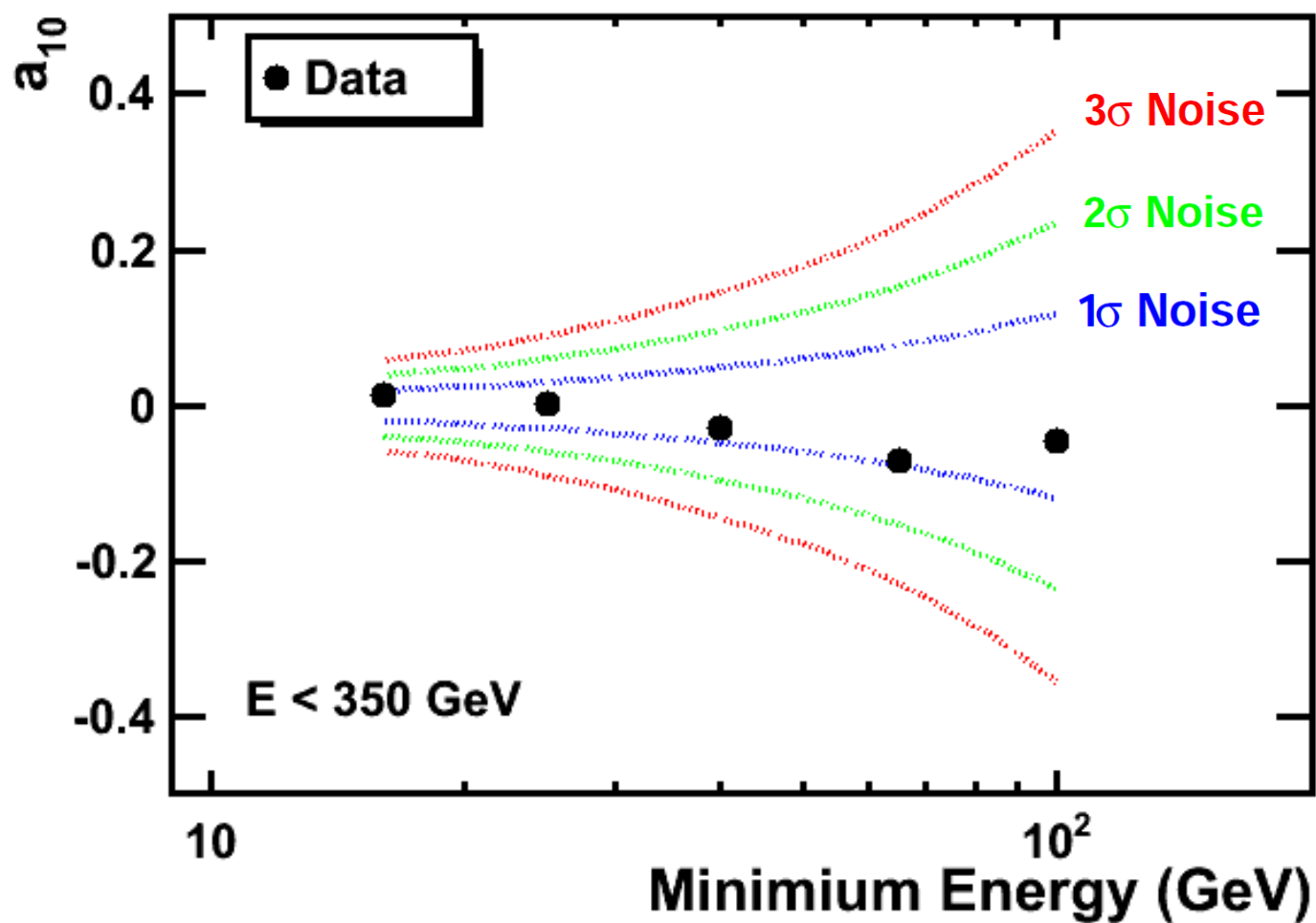



F/B

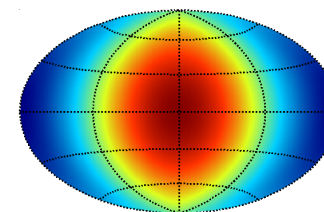

Dipole amplitude a_{11}

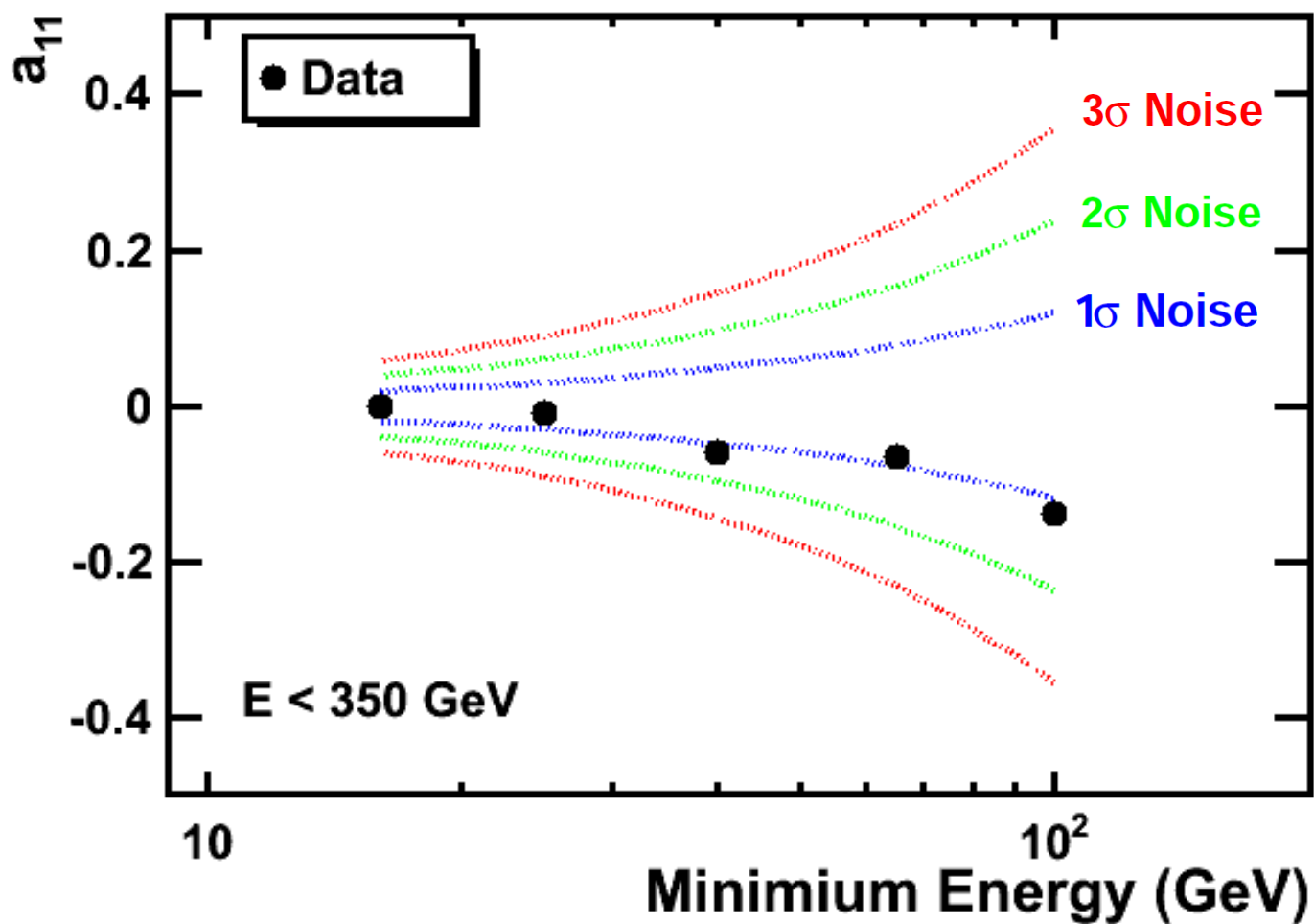



AMS upper limits on δ at the 95% CL

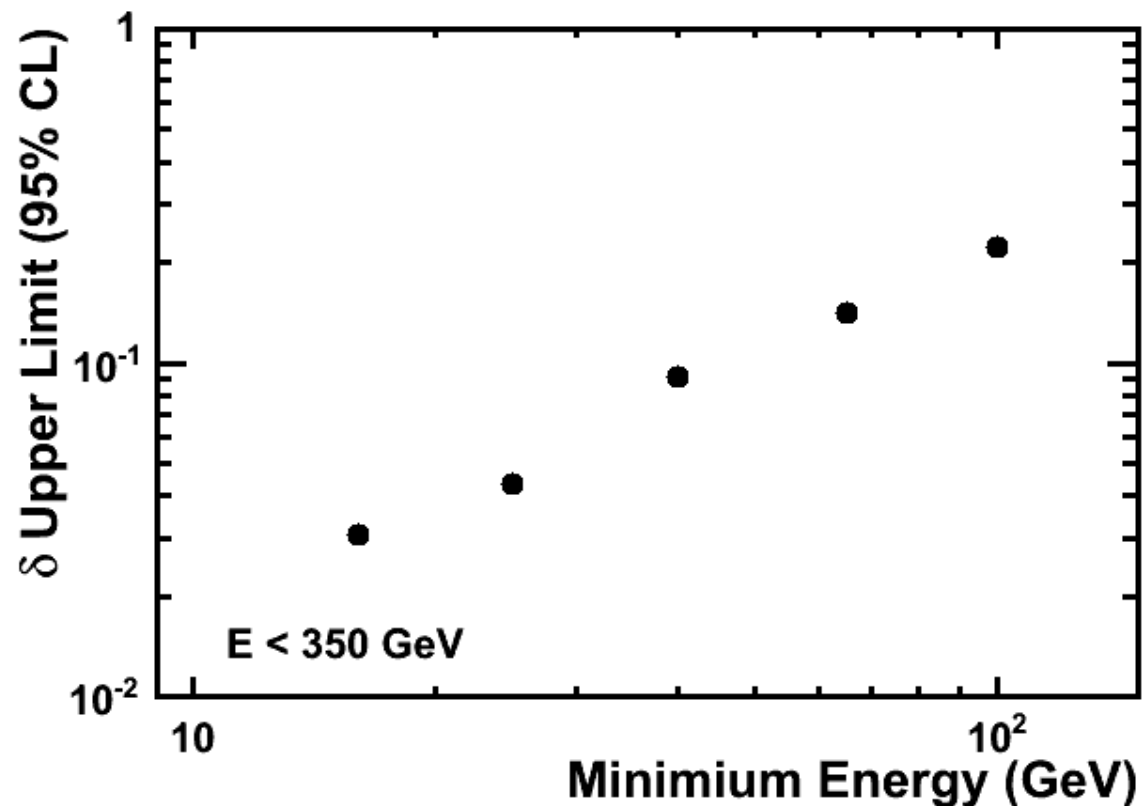

$\delta < 0.030$ for $16 < E < 350 \text{ GeV}$

No seasonal excess is observed and same results are obtained using solar ecliptic coordinates



Anisotropy Discovery Potential

In 10 years, the projected sensitivity of AMS to a dipole anisotropy is 2σ for $\delta=0.010$ and 3σ for $\delta=0.014$

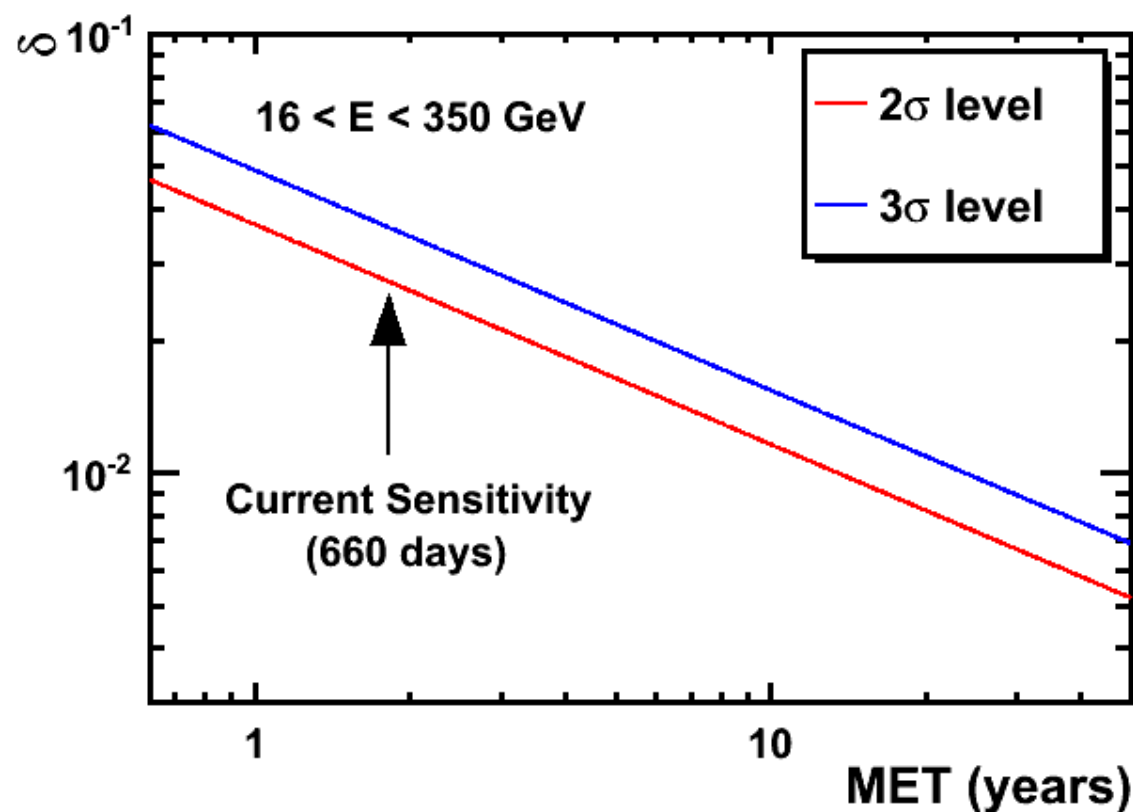



New results from AMS

2) Proton flux

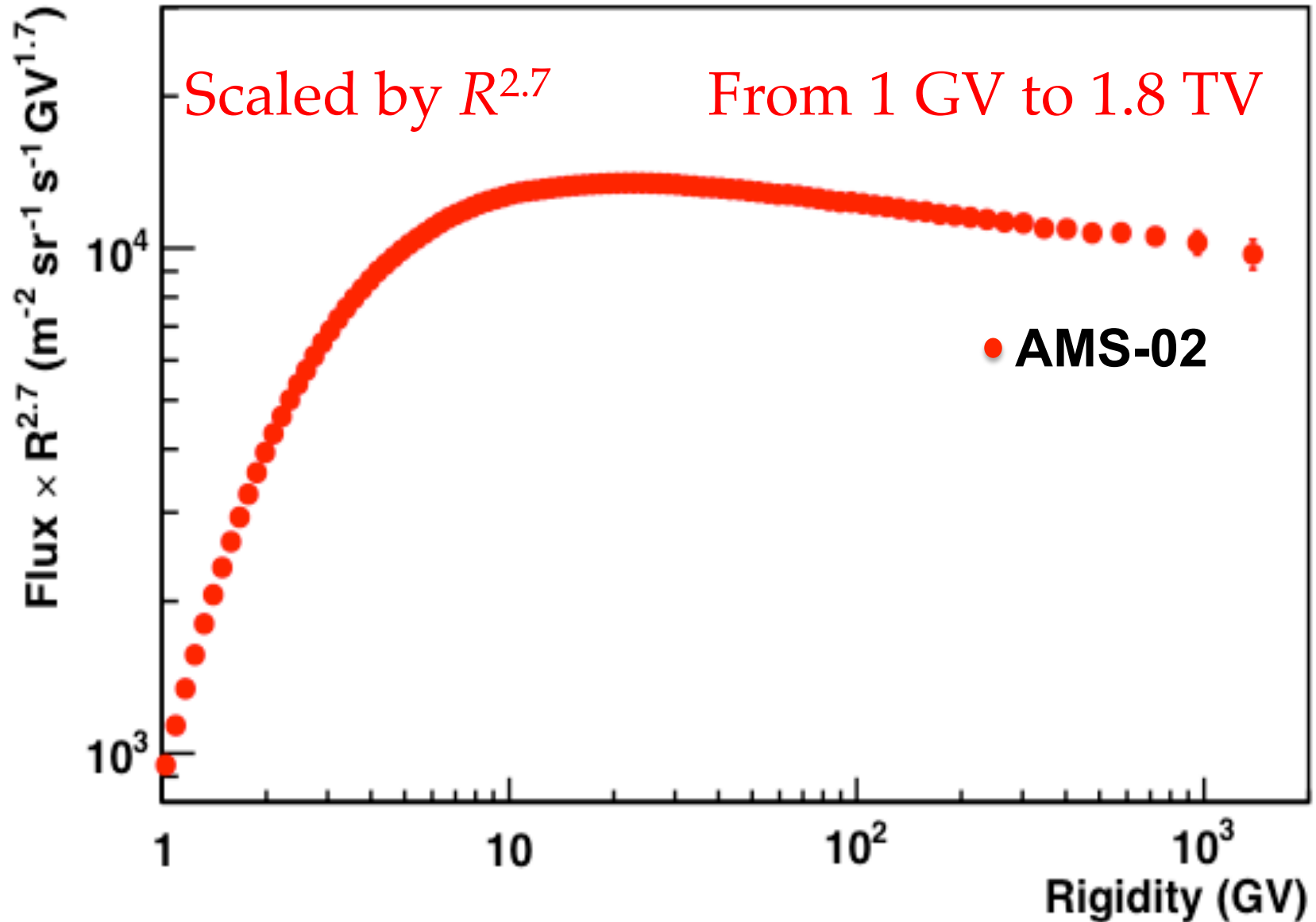



Proton flux

Comparison with past measurements

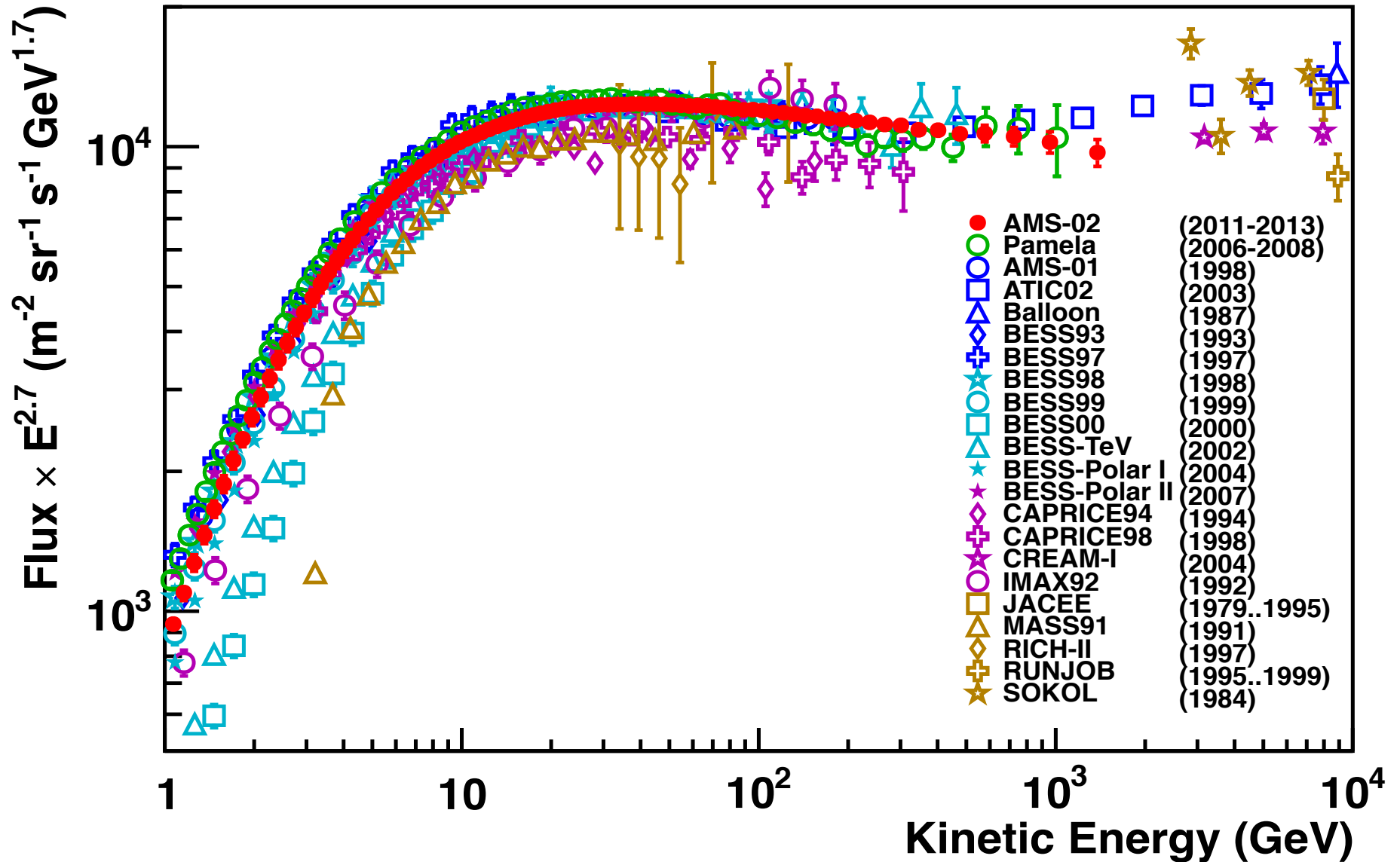



New Results from AMS

3) Helium flux

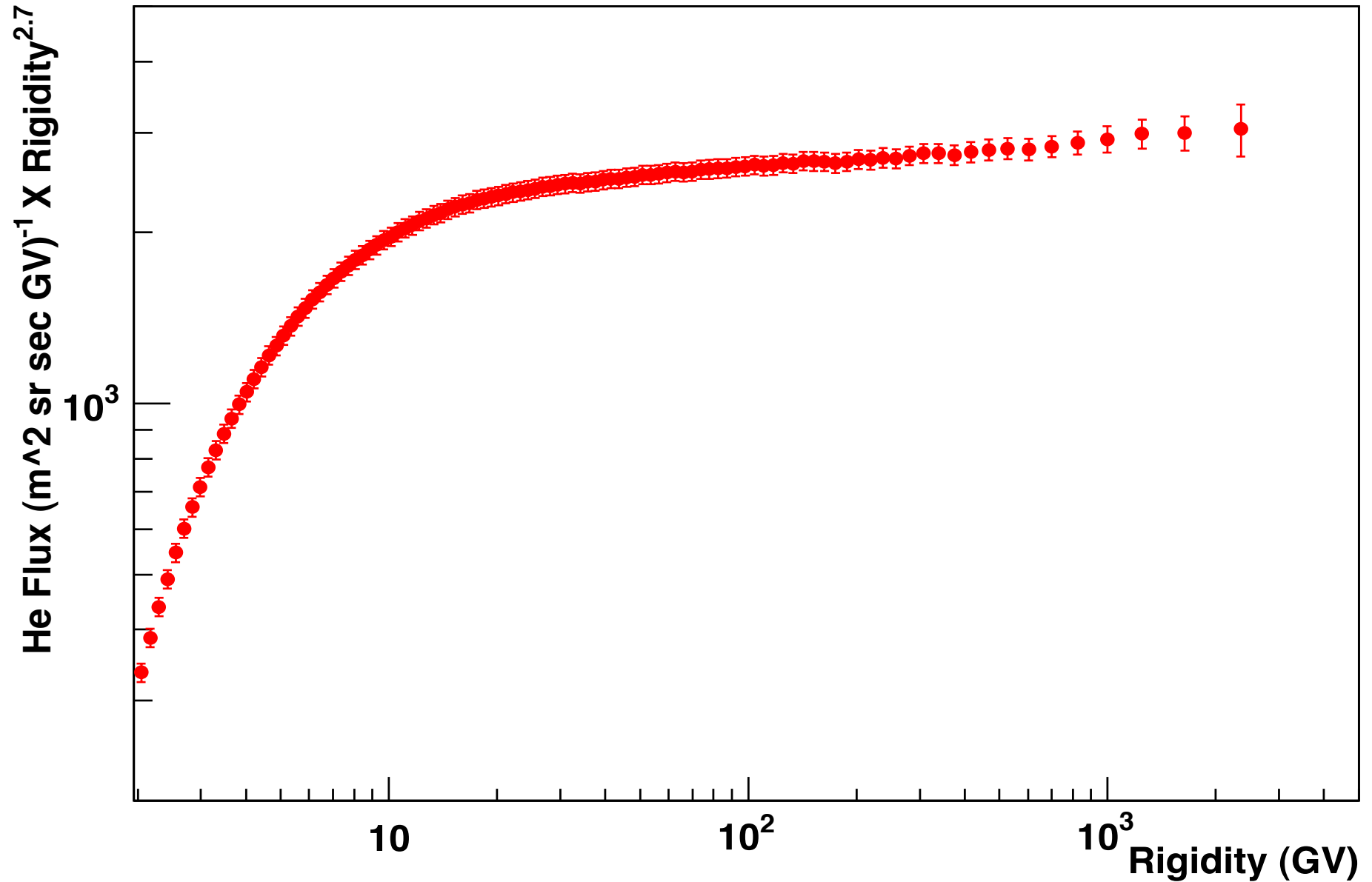



Helium flux

Comparison with past measurements

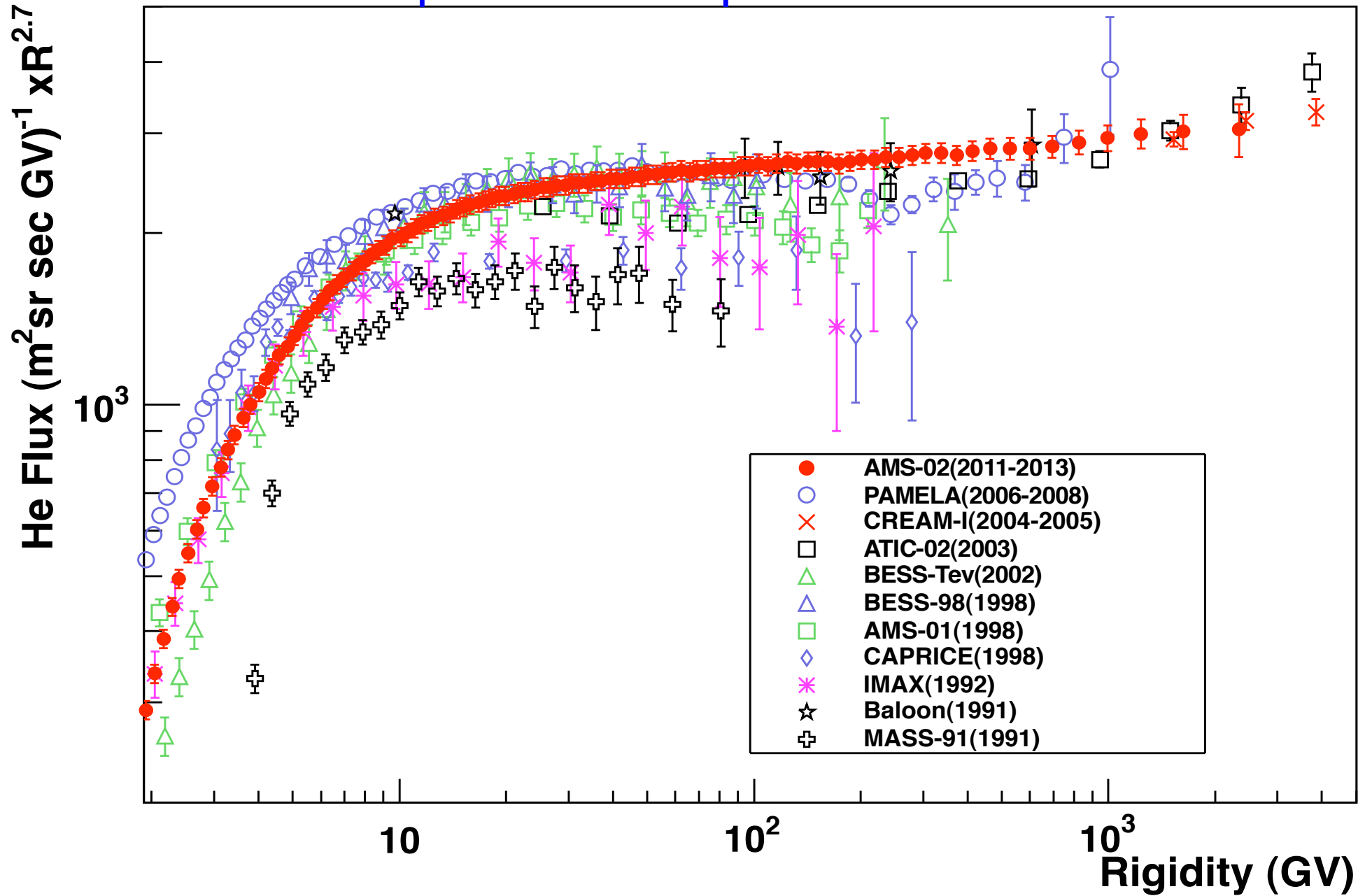



PAMELA Measurements of Cosmic-Ray Proton and Helium Spectra

O. Adriani *et al.*
Science **332**, 69 (2011);
 DOI: 10.1126/science.1199172

PAMELA Measurements of Cosmic-Ray Proton and Helium Spectra

O. Adriani,^{1,2} G. C. Barbarino,^{3,4} G. A. Bazilevskaya,⁵ R. Bellotti,^{6,7} M. Boezio,⁸
 E. A. Bogomolov,⁹ L. Bonechi,^{1,2} M. Bongi,² V. Bonvicini,⁸ S. Borisov,^{10,11,12} S. Bottai,²
 A. Bruno,^{6,7} F. Cafagna,⁷ D. Campana,⁴ R. Carbone,^{4,11} P. Carlson,¹³ M. Casolino,¹⁰
 G. Castellini,¹⁴ L. Consiglio,⁴ M. P. De Pascale,^{10,11} C. De Santis,^{10,11} N. De Simone,^{10,11}
 V. Di Felice,¹⁰ A. M. Galper,¹² W. Gillard,¹³ L. Grishantseva,¹² G. Jerse,^{8,15} A. V. Karelin,¹²
 S. V. Koldashov,¹² S. Y. Krutkov,⁹ A. N. Kvashnin,⁵ A. Leonov,¹² V. Malakhov,¹² V. Malvezzi,¹⁰
 L. Marcelli,¹⁰ A. G. Mayorov,¹² W. Menn,¹⁶ V. V. Mikhailov,¹² E. Mocchiutti,⁸ A. Monaco,^{6,7}
 N. Mori,^{1,2} N. Nikonov,^{9,10,11} G. Osteria,⁴ F. Palma,^{10,11} P. Papini,² M. Pearce,¹³
 P. Picozza,^{10,11} C. Pizzolotto,⁸ M. Ricci,¹⁷ S. B. Ricciardini,² L. Rossetto,¹³ R. Sarkar,⁸
 M. Simon,¹⁶ R. Sparvoli,^{10,11} P. Spillantini,^{1,2} Y. I. Stozhkov,⁵ A. Vacchi,⁸ E. Vannuccini,²
 G. Vasilyev,⁹ S. A. Voronov,¹² Y. T. Yurkin,¹² J. Wu,^{13†} G. Zampa,⁸ N. Zampa,⁸ V. G. Zverev¹²

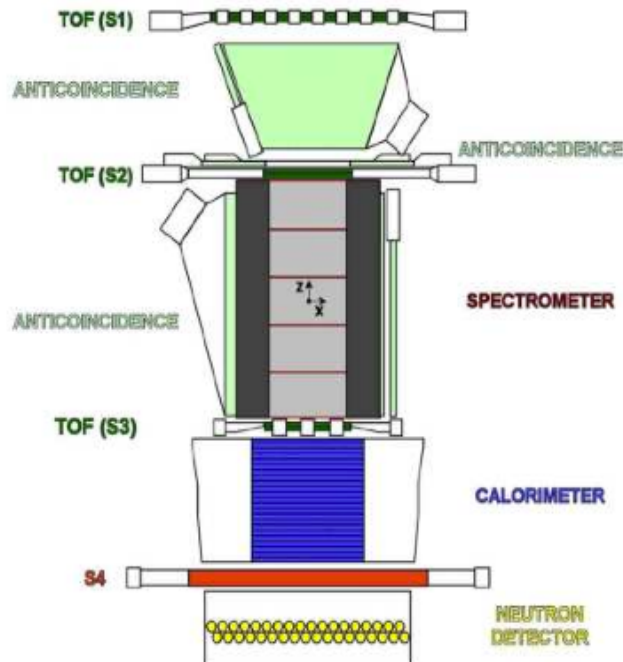

Proton

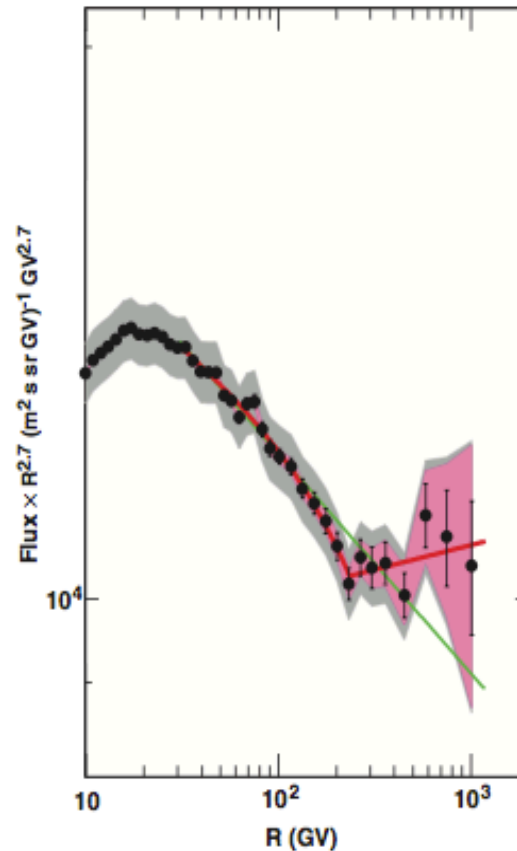

Helium

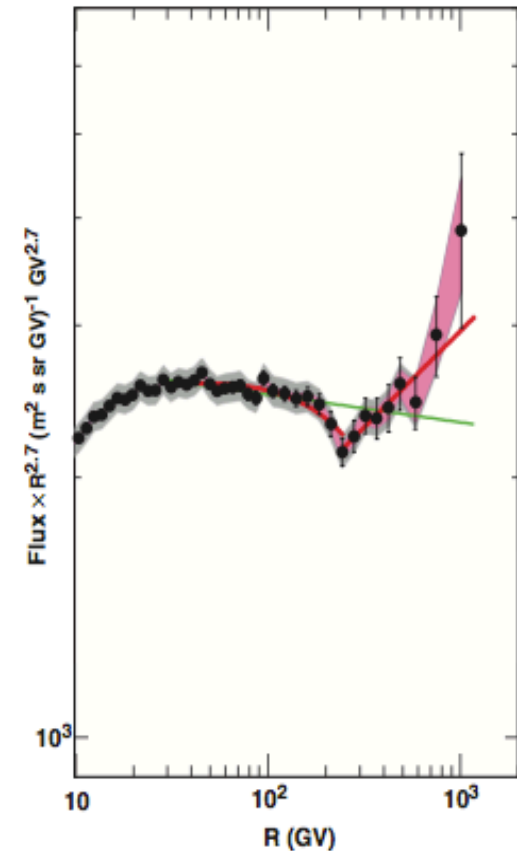
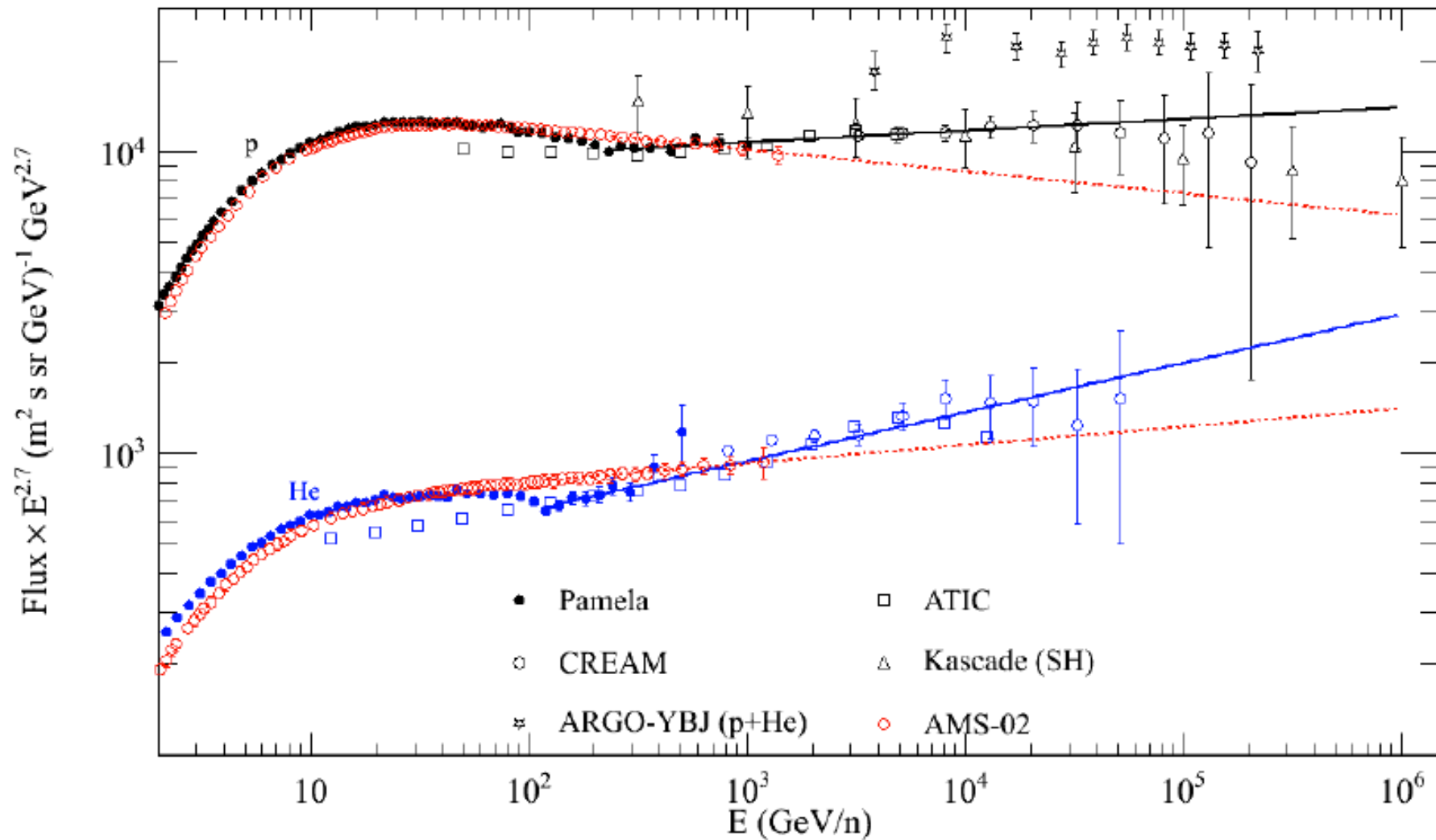
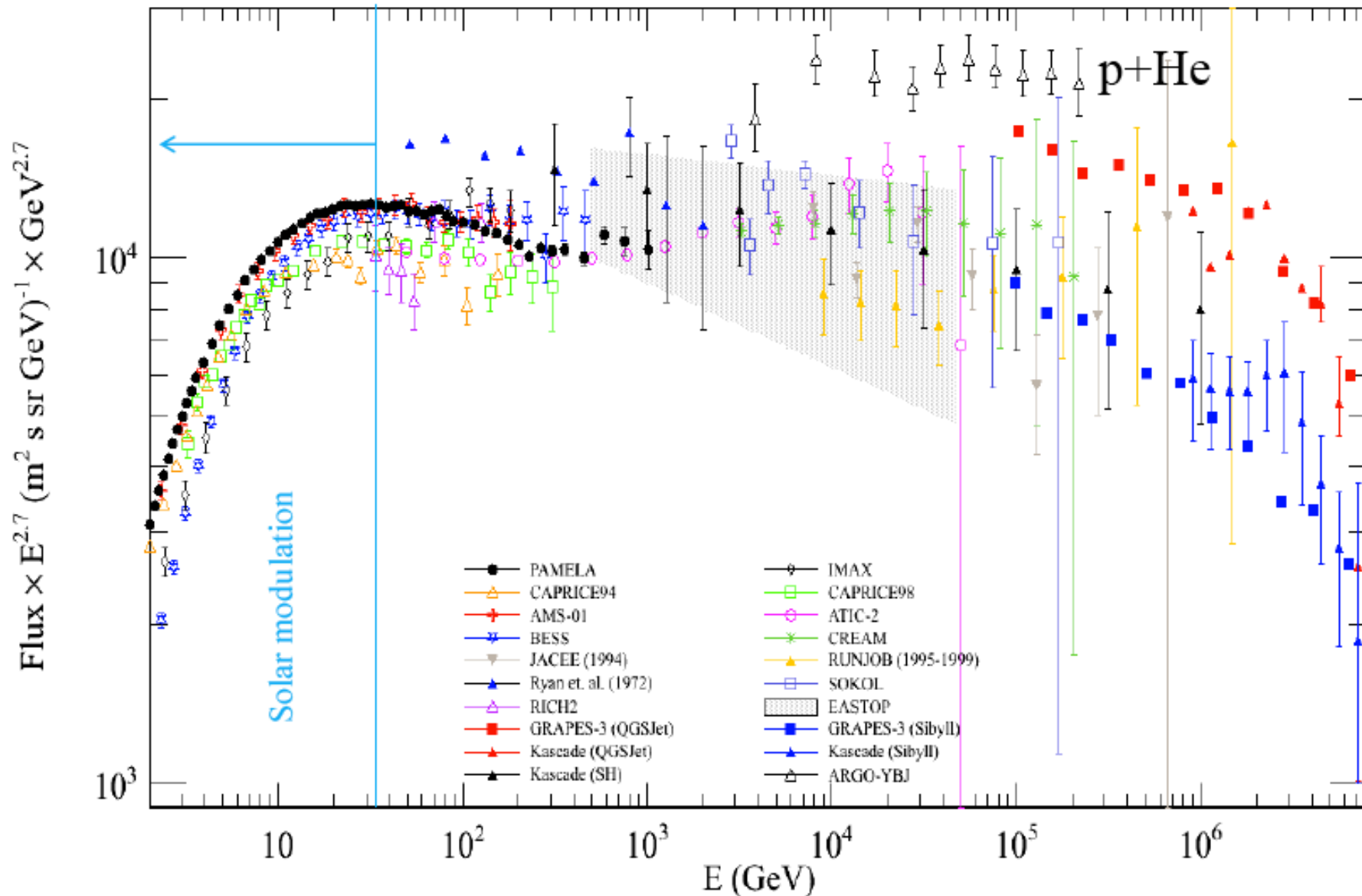

Fig. 4. Proton (left) and helium (right) spectra in the range 10 GV to 1.2 TV. The gray shaded area represents the estimated systematic uncertainty, and the pink shaded area represents the contribution due to tracker alignment. The green lines represent fits with a single power law in the rigidity range 30 to 240 GV. The red curves represent the fit with a rigidity-dependent power law (30 to 240 GV) and with a single power law above 240 GV.

Proton and Helium Nuclei Spectra



Proton (Hydrogen) Spectrum





New results from AMS

4) Electron Spectrum

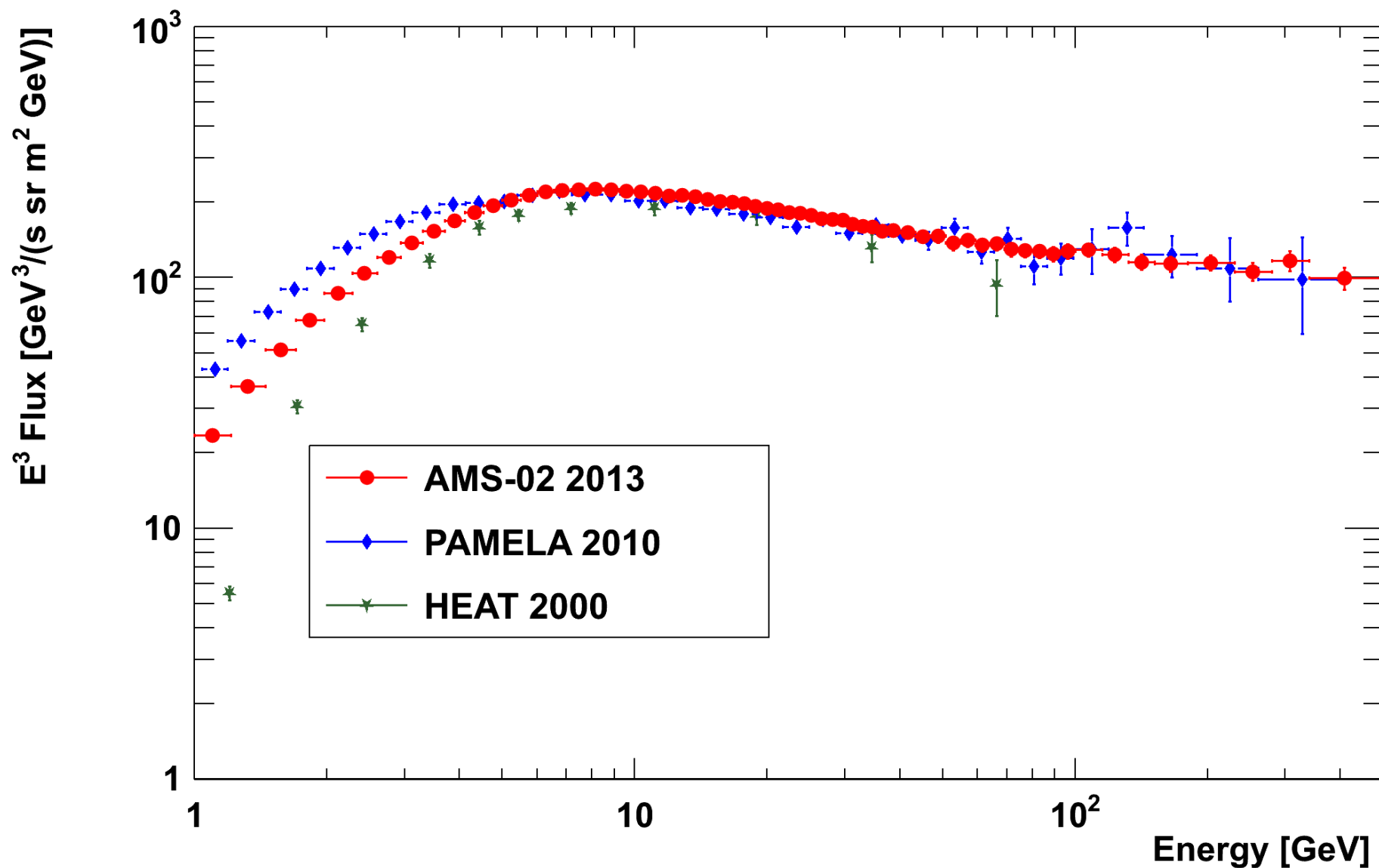



New results from AMS

5) Positron Spectrum

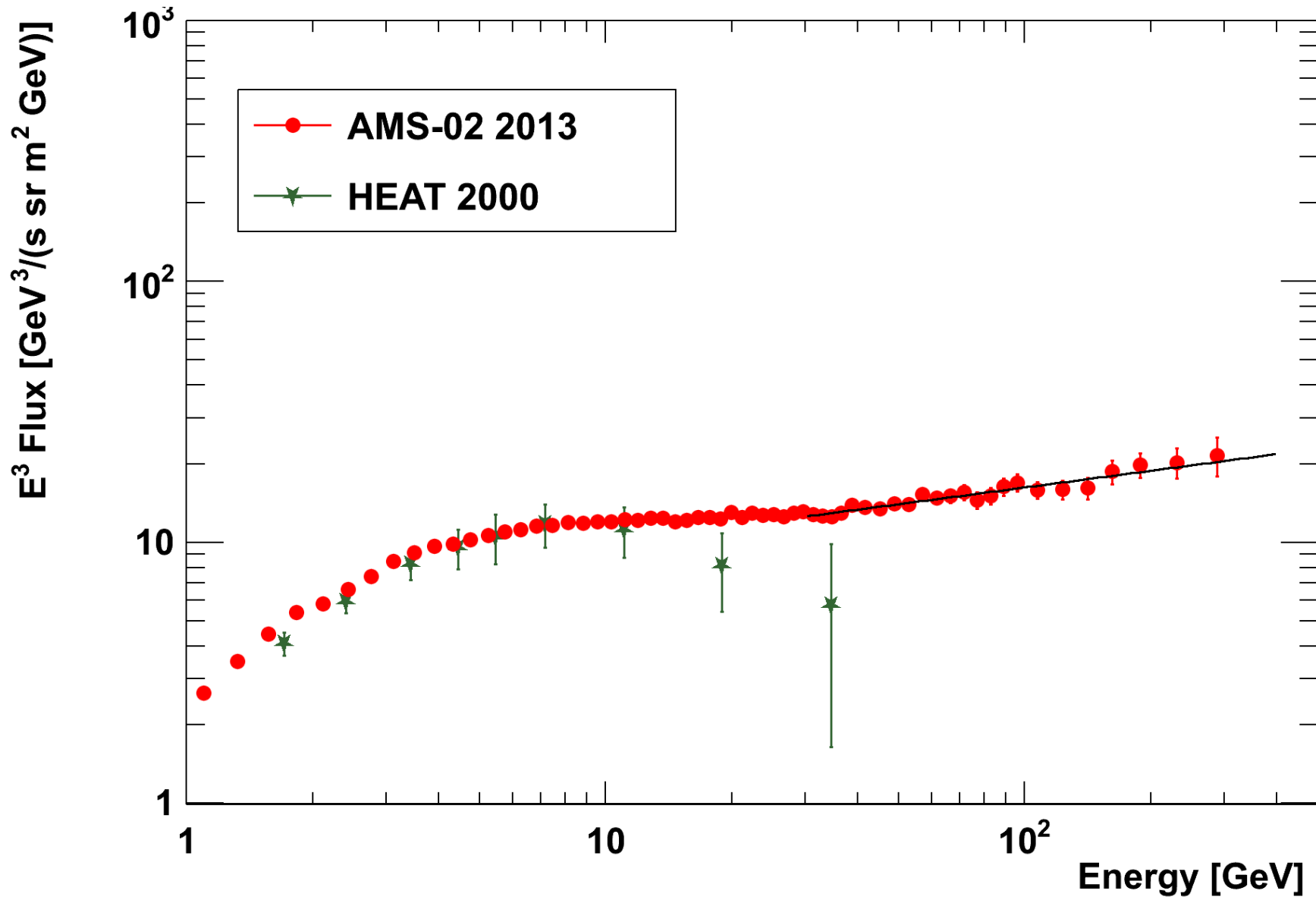



New results from AMS

6) (Electron plus Positron) Spectrum

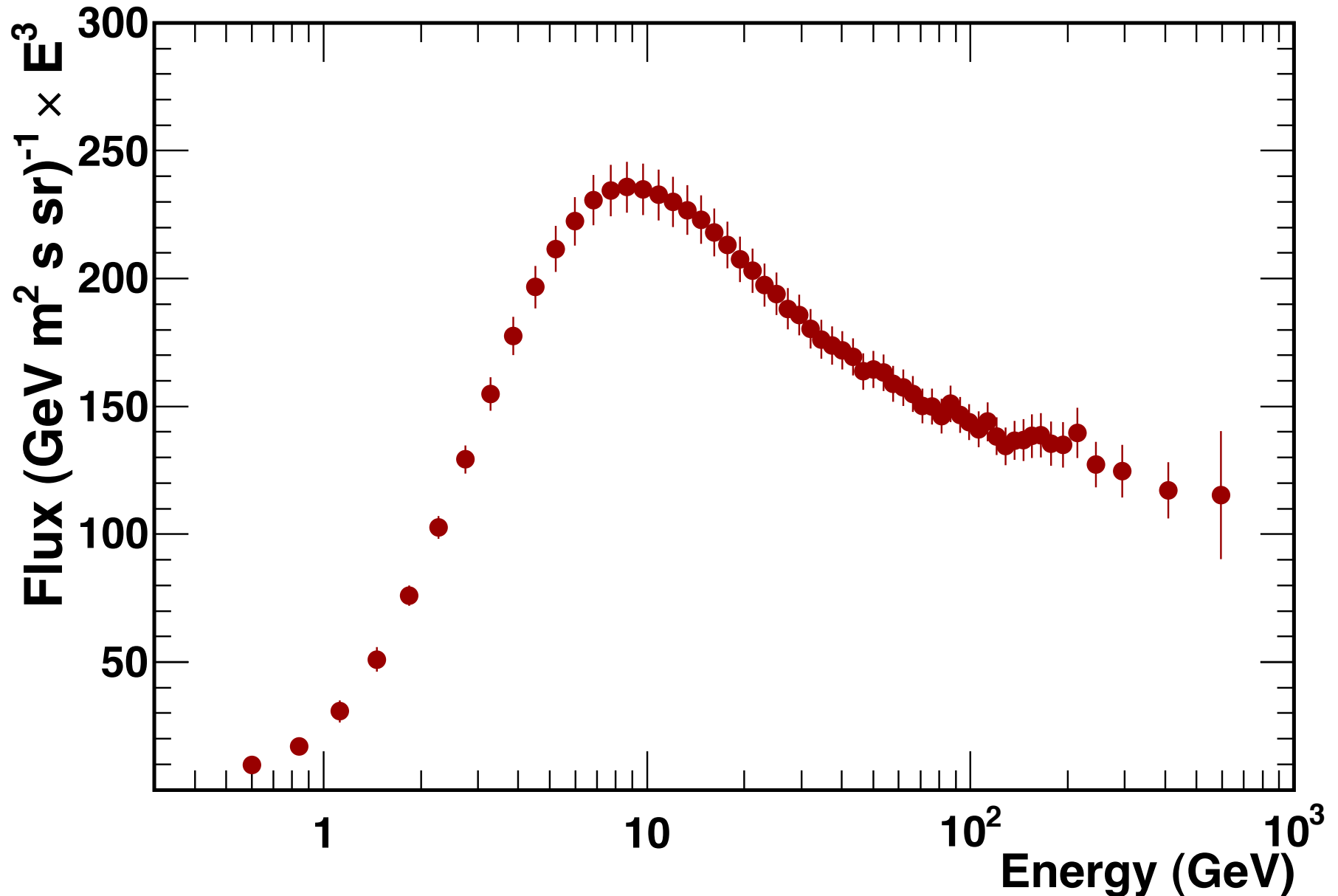



(Electron plus Positron) Spectrum comparison with recent measurements

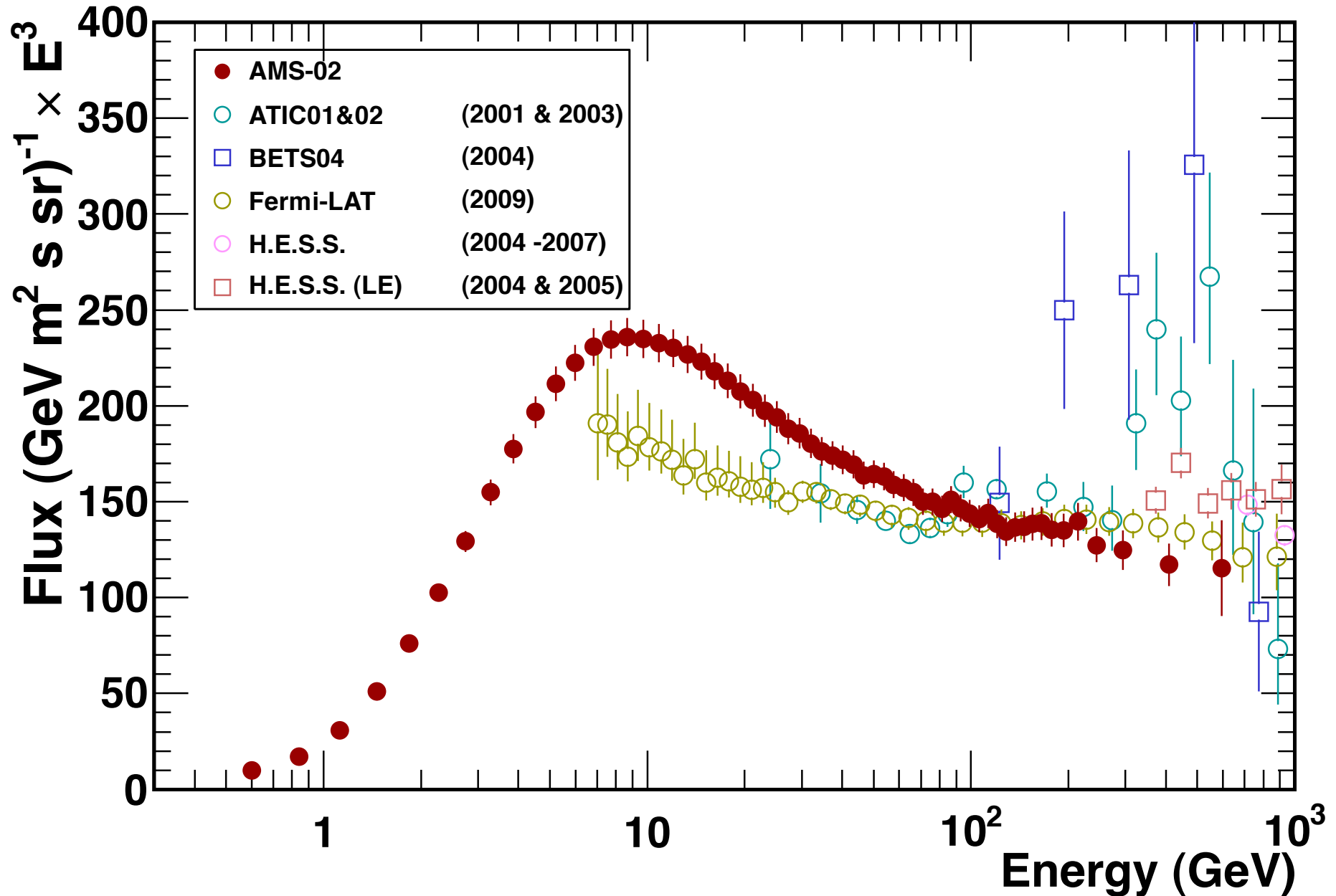



New results from AMS

7) Boron-to-Carbon ratio

Precise measurement of the energy spectra of B/C provides information on Cosmic Ray Interactions and Propagation

AMS: Multiple Independent Measurements of the Charge ($|Z|$)

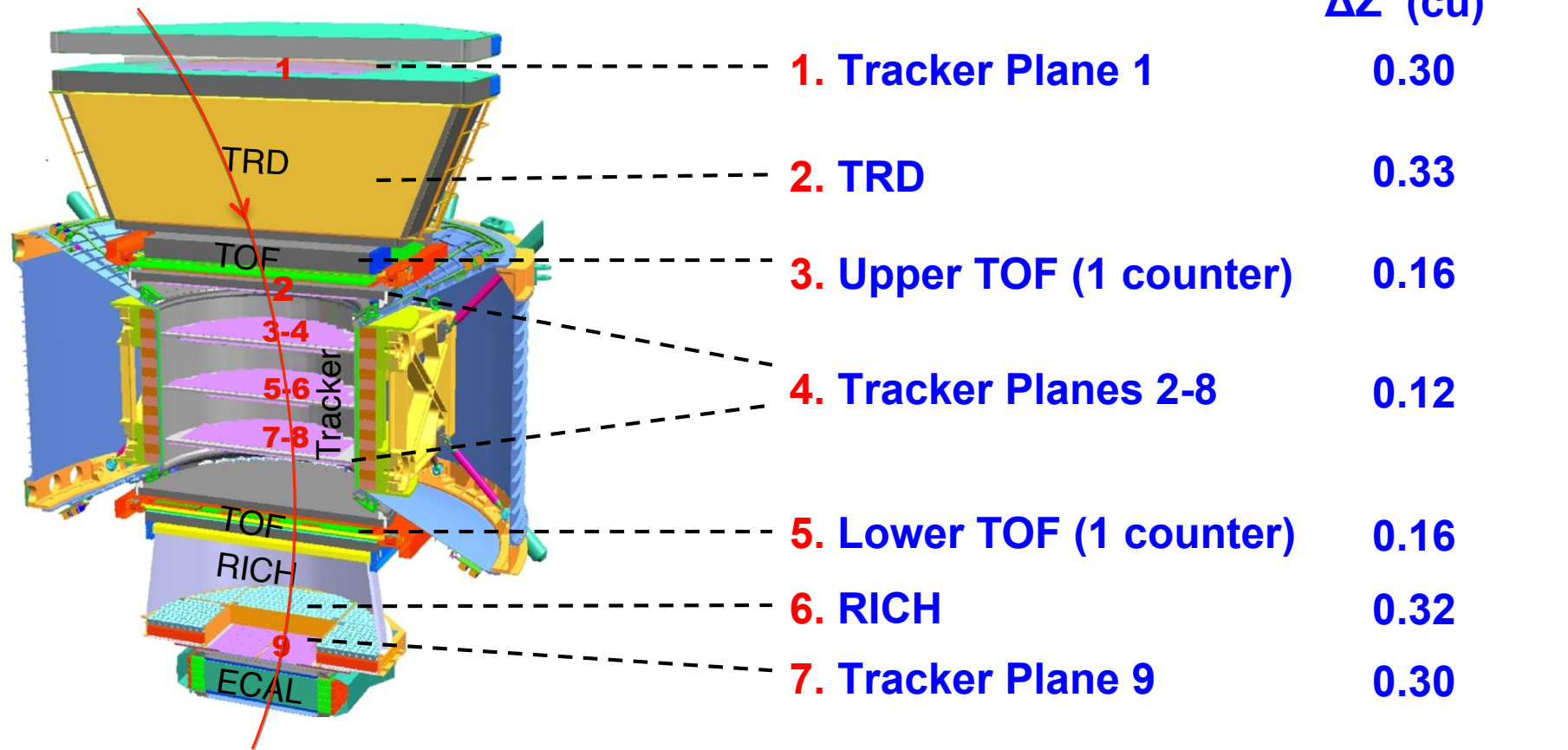

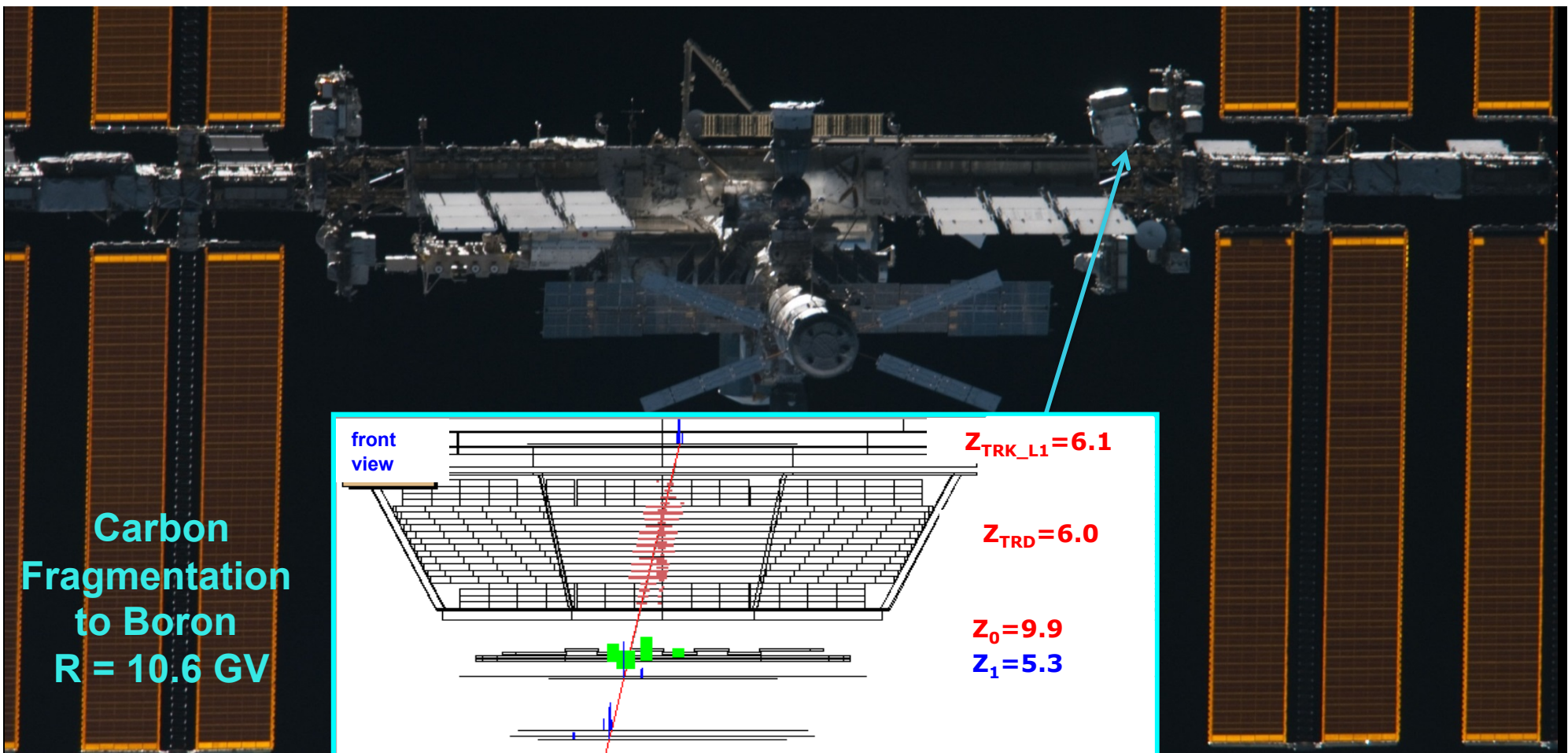

Carbon
Fragmentation
to Boron
 $R = 10.6 \text{ GV}$

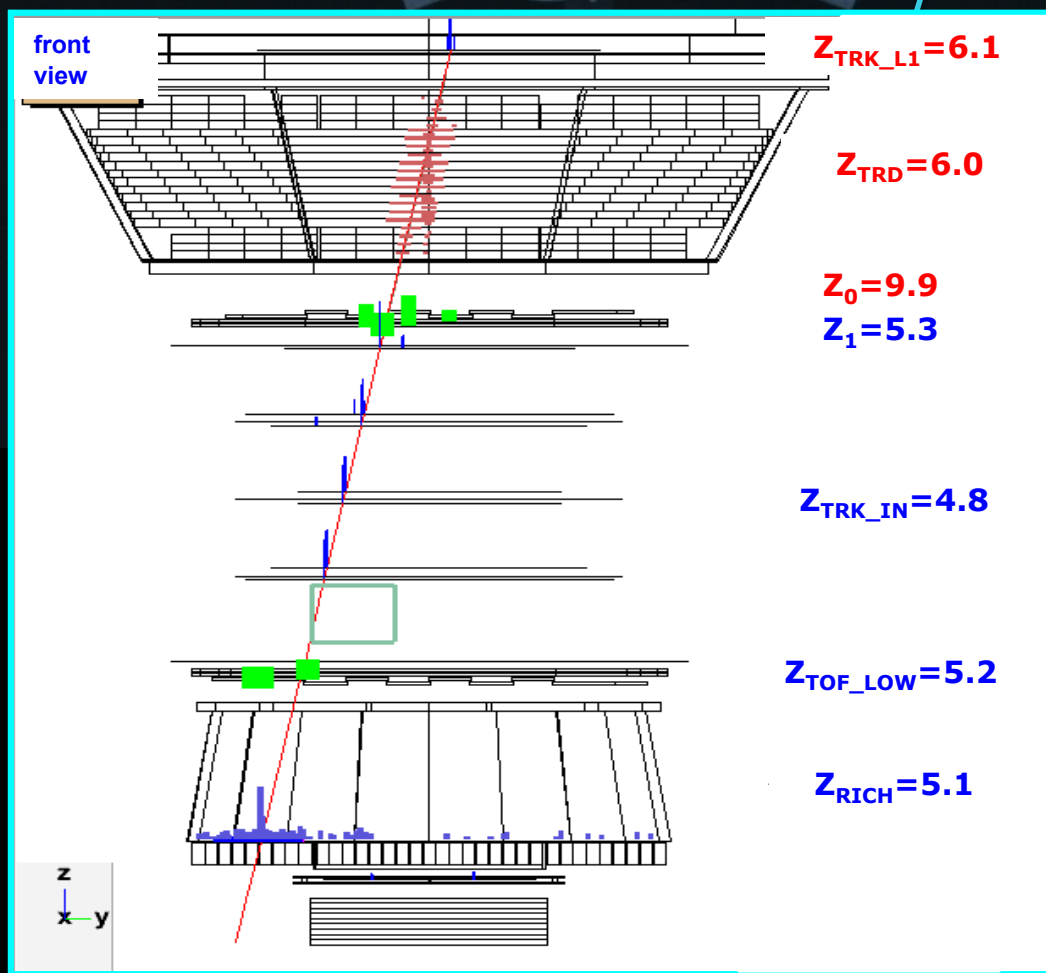



Boron-to-Carbon ratio

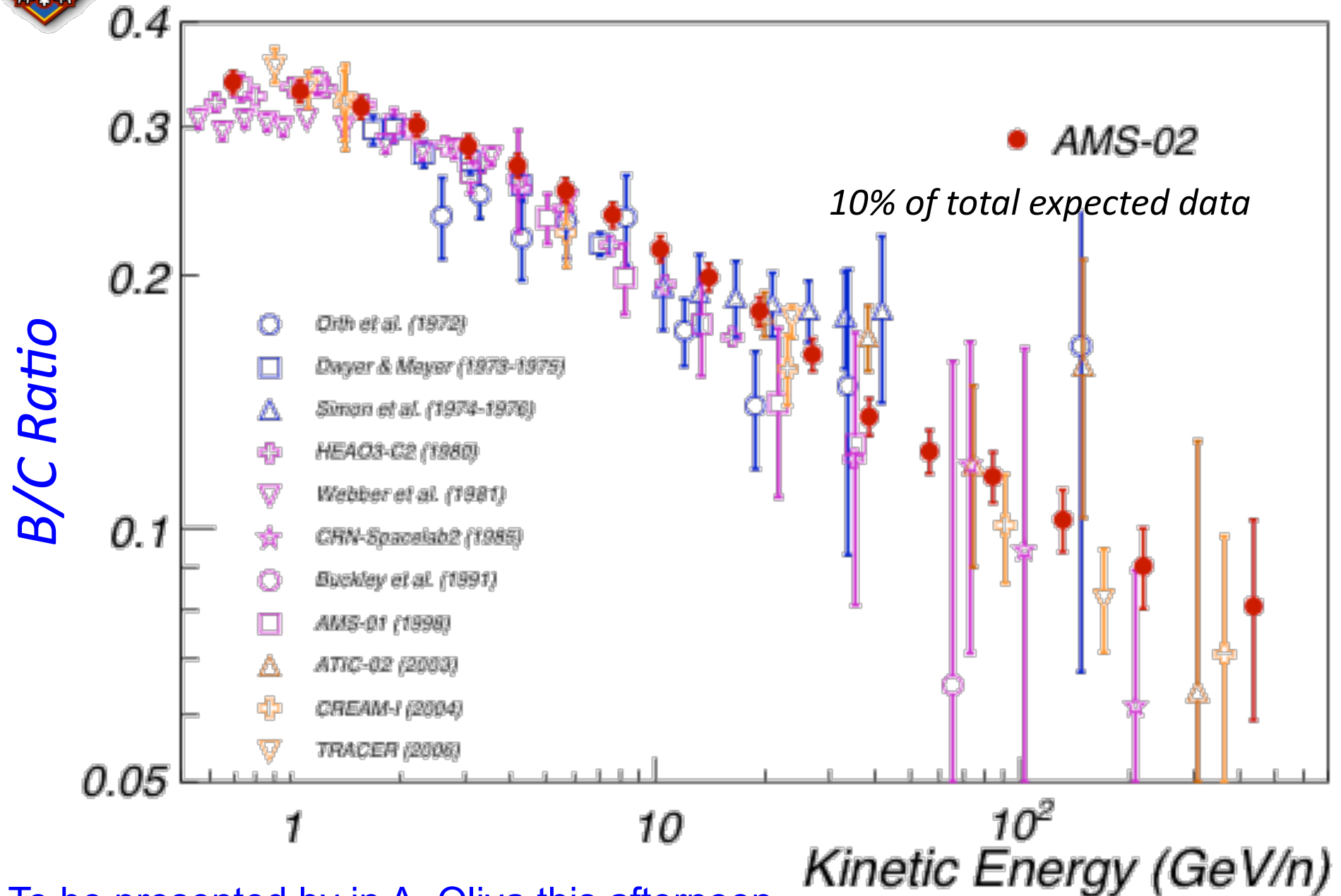

To be presented by in A. Oliva this afternoon



Boron-to-Carbon ratio

comparison with recent data

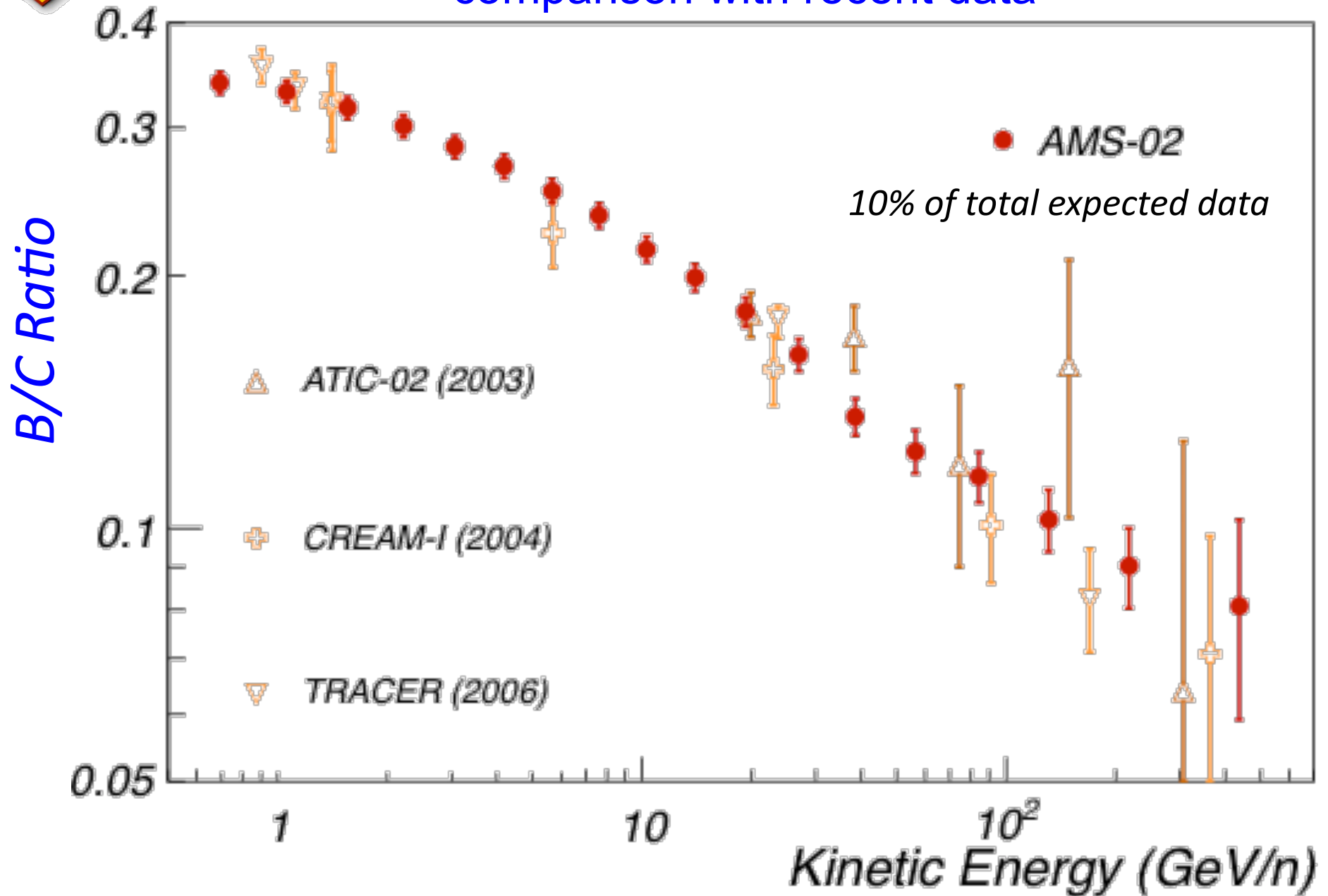

AMS Nuclei Measurement on ISS

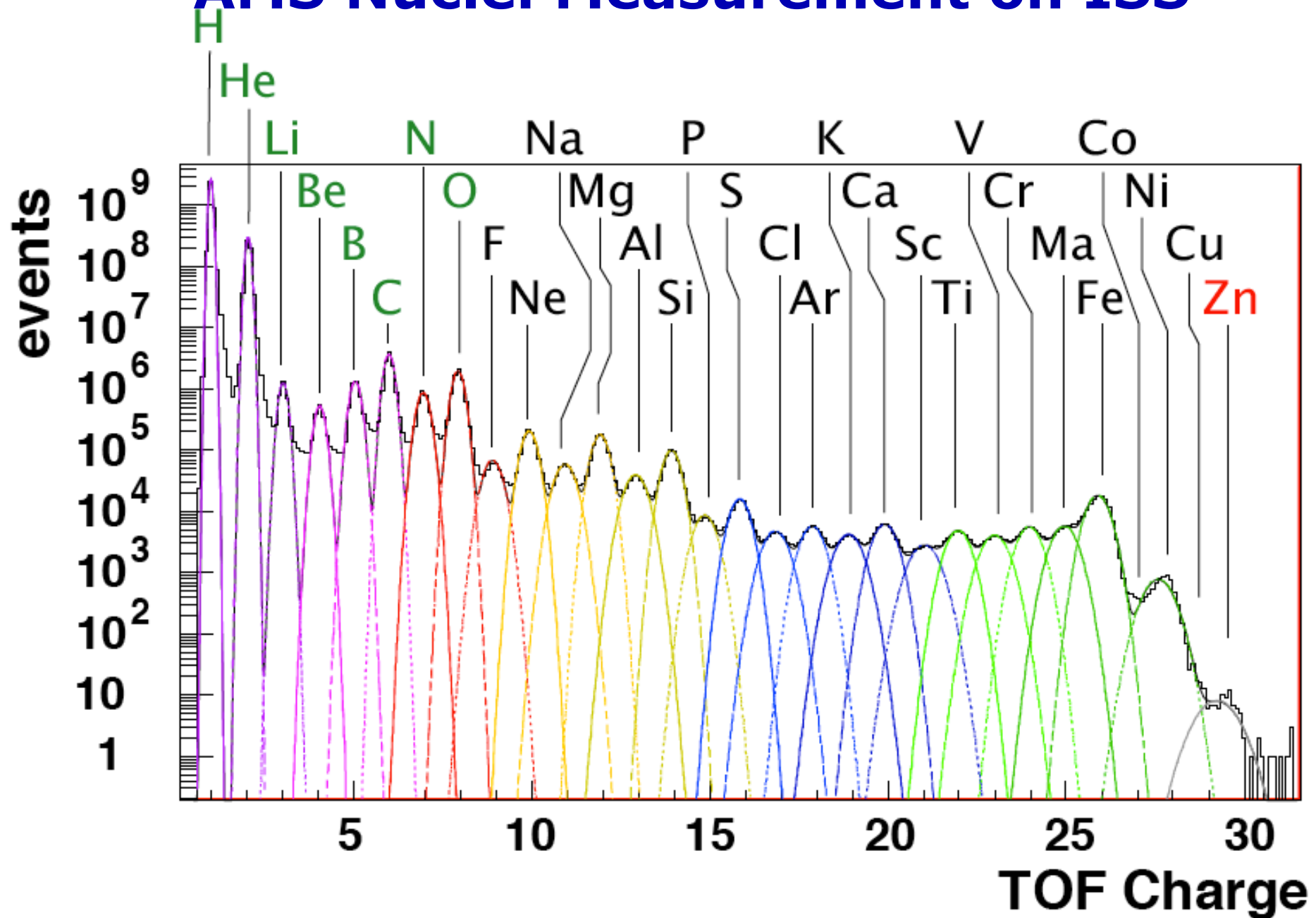

We now understand
the systematic errors to $\sim 1\%$.

Studies with 1% statistical error
will take time to collect the data.

Physics analysis nearing completion

- 1. Antiprotons (0.5-300 GeV)**
- 2. Anti-He (@ few 10^8 events)**
- 3. Solar physics**
- 4. Ion fluxes**
- 5.**

The Cosmos is the Ultimate Laboratory.

Cosmic rays can be observed at energies higher than any accelerator.



With AMS-02 on the ISS we have entered the era of precision Cosmic Ray physics to search for phenomena which exist in nature but we have not yet imagined nor had the tools to discover.