

Relativistic nuclear collisions: main goals, recent achievements, and future opportunities

i

Outline:

- The general context: QCD and extreme matter
- Fundamental questions
- The hot fireball and the QCD phase boundary
- The 'high baryon density' regime – are there new phases?
- Strongly coupled systems, flow and parton energy loss
- Heavy quarks, quarkonia, and deconfinement
- Outlook and strategical issues

pbm, IUPAP WG9 meeting, Frascati, Italy, May 31, 2013

The phase diagram of strongly interacting matter

at low temperature and normal density

colored quarks and gluons are bound in colorless hadrons - **confinement**
chiral symmetry is spontaneously broken (generating 99% of proton mass e.g.)

1972 QCD (Gross, Politzer, Wilczek)
asymptotic freedom at small distances

at high temperature and/or high density

quarks and gluons freed from confinement

-> new state of strongly interacting matter

1975 (Collins/Perry and

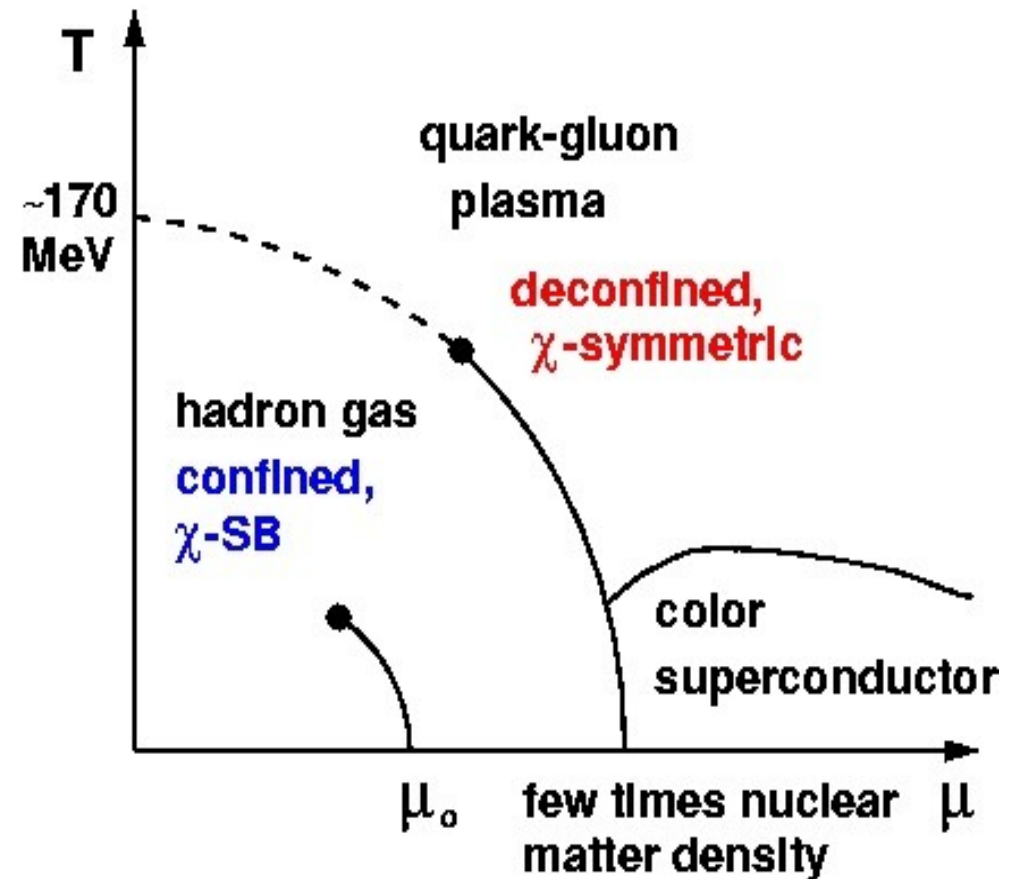

Evolution of the Early Universe

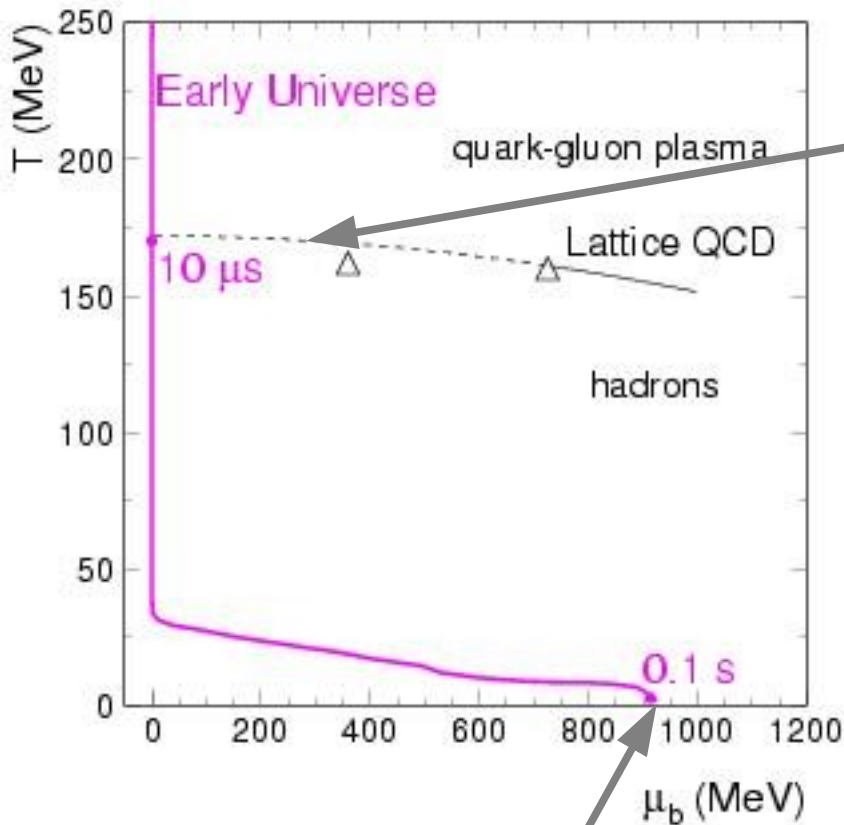

QCD Phase Boundary

Homogeneous Universe in Equilibrium, this matter can only be investigated in nuclear collisions

- Charge neutrality
- Net lepton number = net baryon number
- Constant entropy/baryon

neutrinos decouple and light nuclei begin to be formed

from ultra-cold to ultra-hot

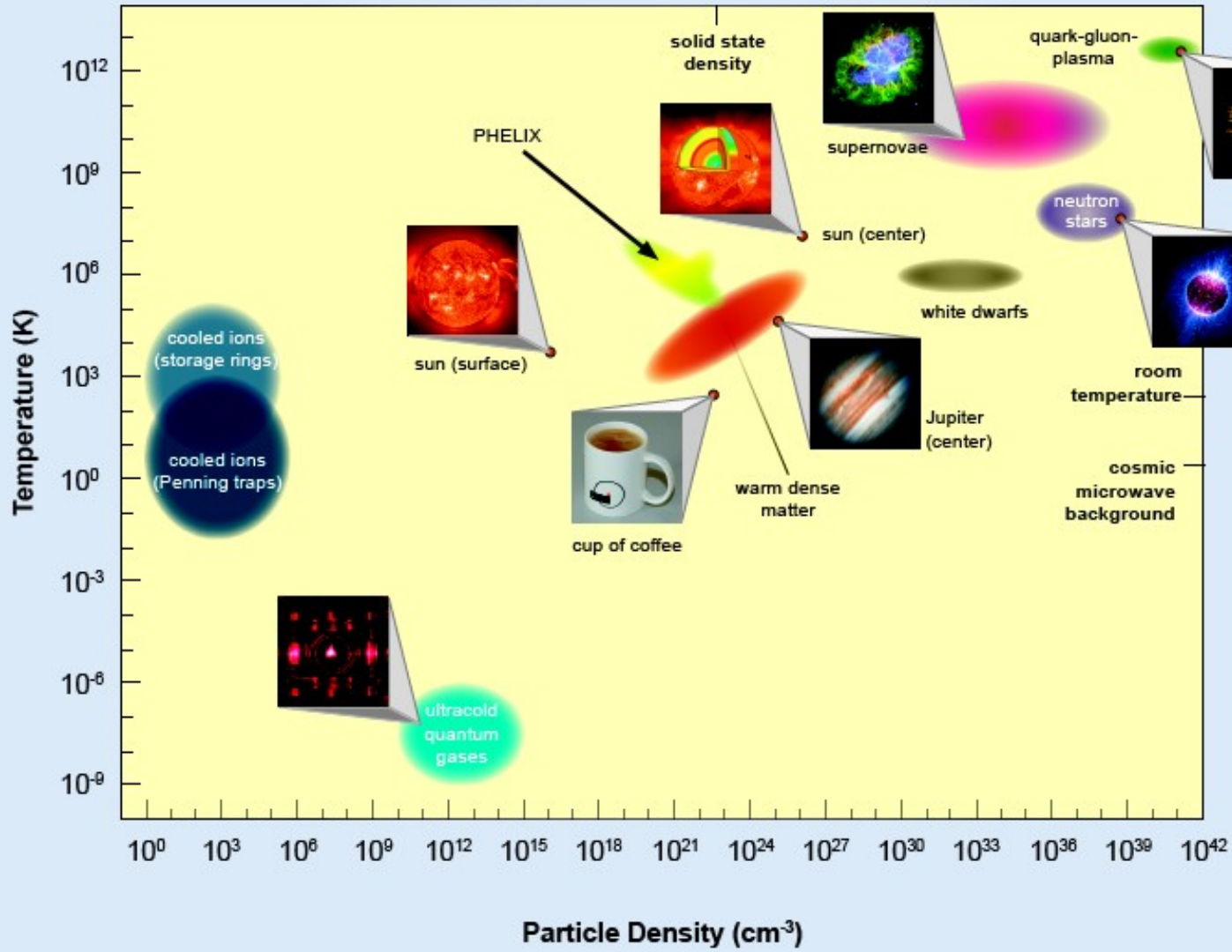

QGP and the 'gauge-gravity' dual

See, e.g. E. Witten, 'Quantum Mechanics of Black Holes, Science 337 (3 August 2012)

The strongly coupled QCD-like gauge theory is dual to weakly coupled gravitation with a large, negative cosmological constant, Kovtun, Son, Starinets, PRL 94 (2005) 111601

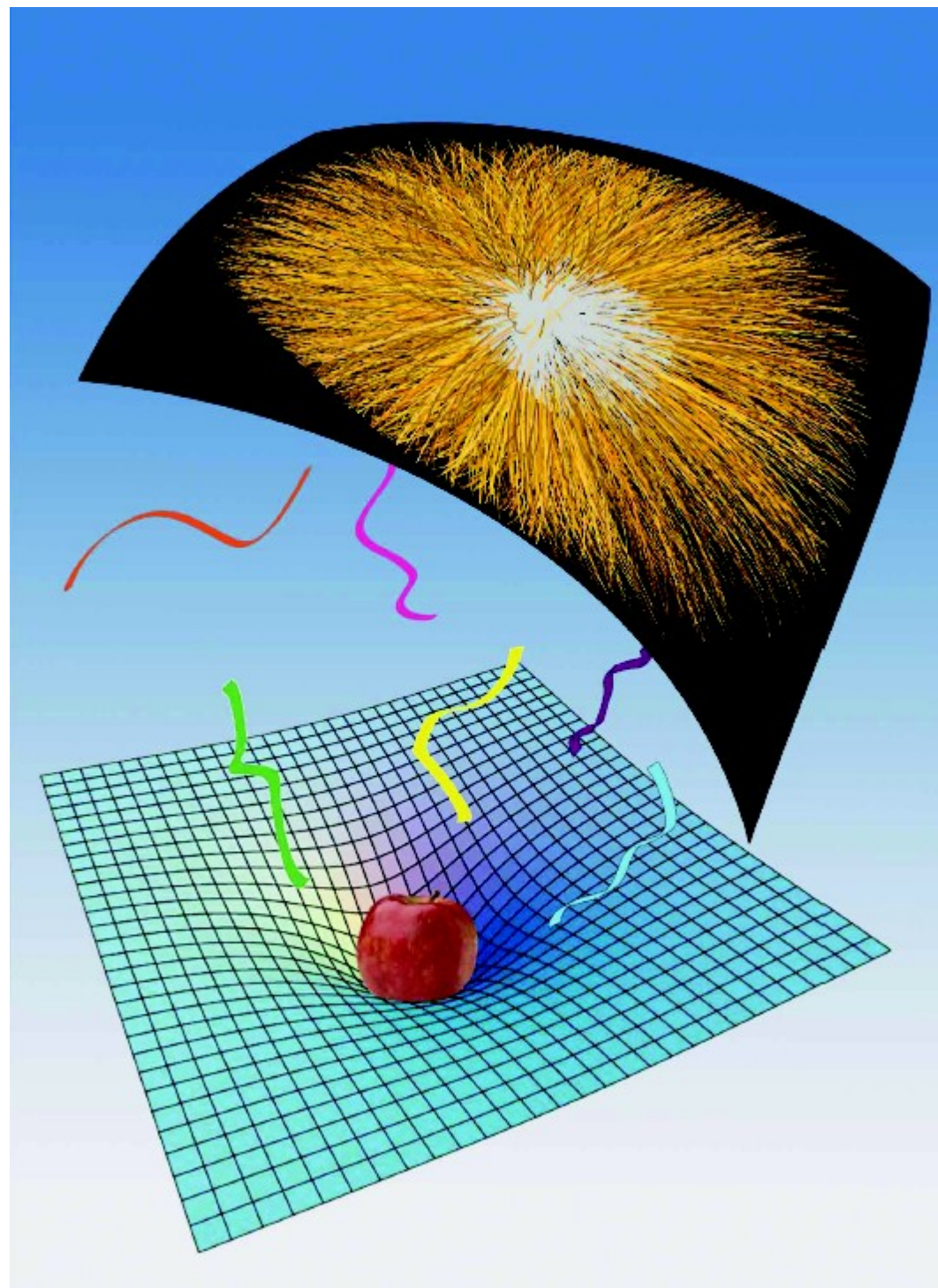

The 'condensed matter' phases of QCD – F. Wilczek, 2000

fundamental questions about extreme matter

- what are the properties of deconfined matter at extreme temperatures and densities, is chiral symmetry restored?
- can the transition temperature to the QGP be measured?
- what are its macroscopic transport parameters and equation of state?
- what is the nature of microscopic excitations and quasi-particles?
- is the QGP a strongly coupled liquid? how is its structure related to other strongly coupled systems?

Relativistic nuclear collisions:

a tool to study bulk properties of non-abelian matter in the laboratory

The tools: accelerators for ultra-relativistic nuclei

	fixed target		collider	
	AGS	SPS	RHIC	LHC
	1987-2000		since 2000	from 2009
beam momentum	$29 \cdot Z \text{ GeV}/c$	$450 \cdot Z \text{ GeV}/c$	$ea 250 \cdot Z \text{ GeV}/c$	$ea 7000 \cdot Z \text{ GeV}/c$
projectile	p...Au	p...Pb	p...Au	p...Pb
energy available in c.m. system	Au+Au 600 GeV	Pb+Pb 3200 GeV	Au+Au 40 TeV	Pb+Pb 1150 TeV
hadrons produced per collision	900	2400	7500	18000

compilation: J. Stachel

RHIC experiments

PHENIX: central 2 arm spectrometer plus forward/backward muon arms



STAR: large TPC at central rapidity

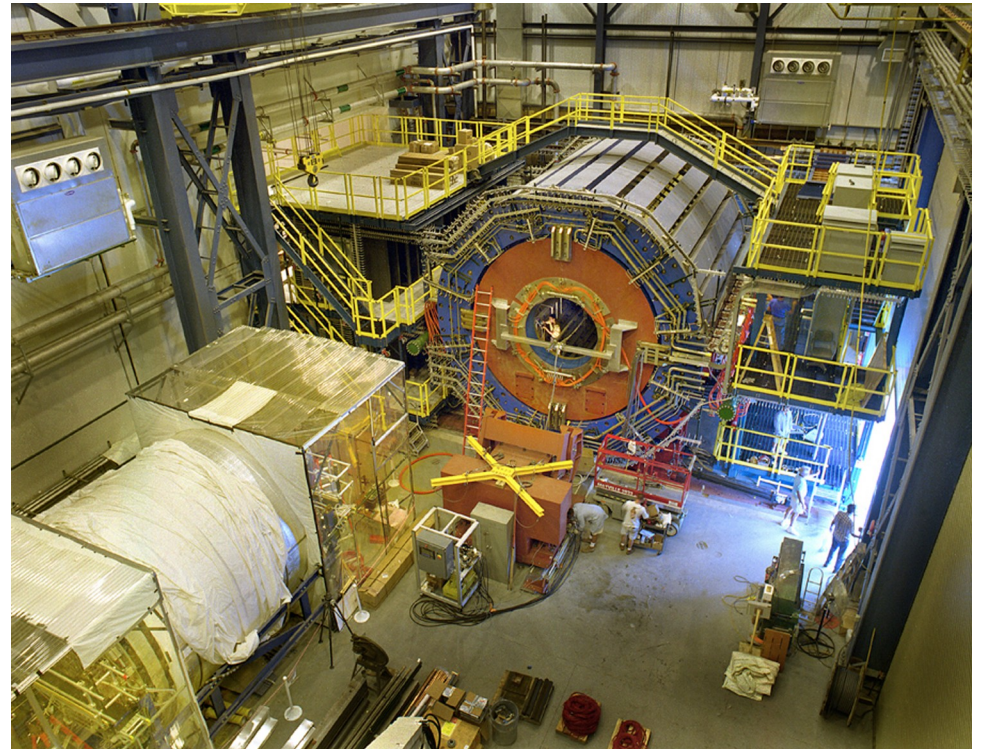

as well as **PHOBOS** and **BRAHMS** (both completed)

The Large Hadron Collider (LHC)



27 km long, 8 sectors

1232 dipole magnets (15m, 30 tonnes each) to bend the beams

Cooled with **120 tonnes of He at 1.9 K**

pp: 2808 bunches/ring, each 1.15×10^{11} protons (8 min filling time)

Design luminosity: **$10^{34} \text{ cm}^{-2}\text{s}^{-1}$**

PbPb: 592 bunches/ring, each 7×10^7 Pb ions

Design luminosity: $10^{27} \text{ cm}^{-2}\text{s}^{-1}$

Transverse r.m.s beam size: **16 μm** , r.m.s. bunch length: 7.5 cm

Beam kinetic energy: 362 MJ per beam (1 MJ melts 2 kg copper)

Total stored electromagnetic energy: **8.5 GJ** (dipole magnets only)

Overall view of the LHC experiments.

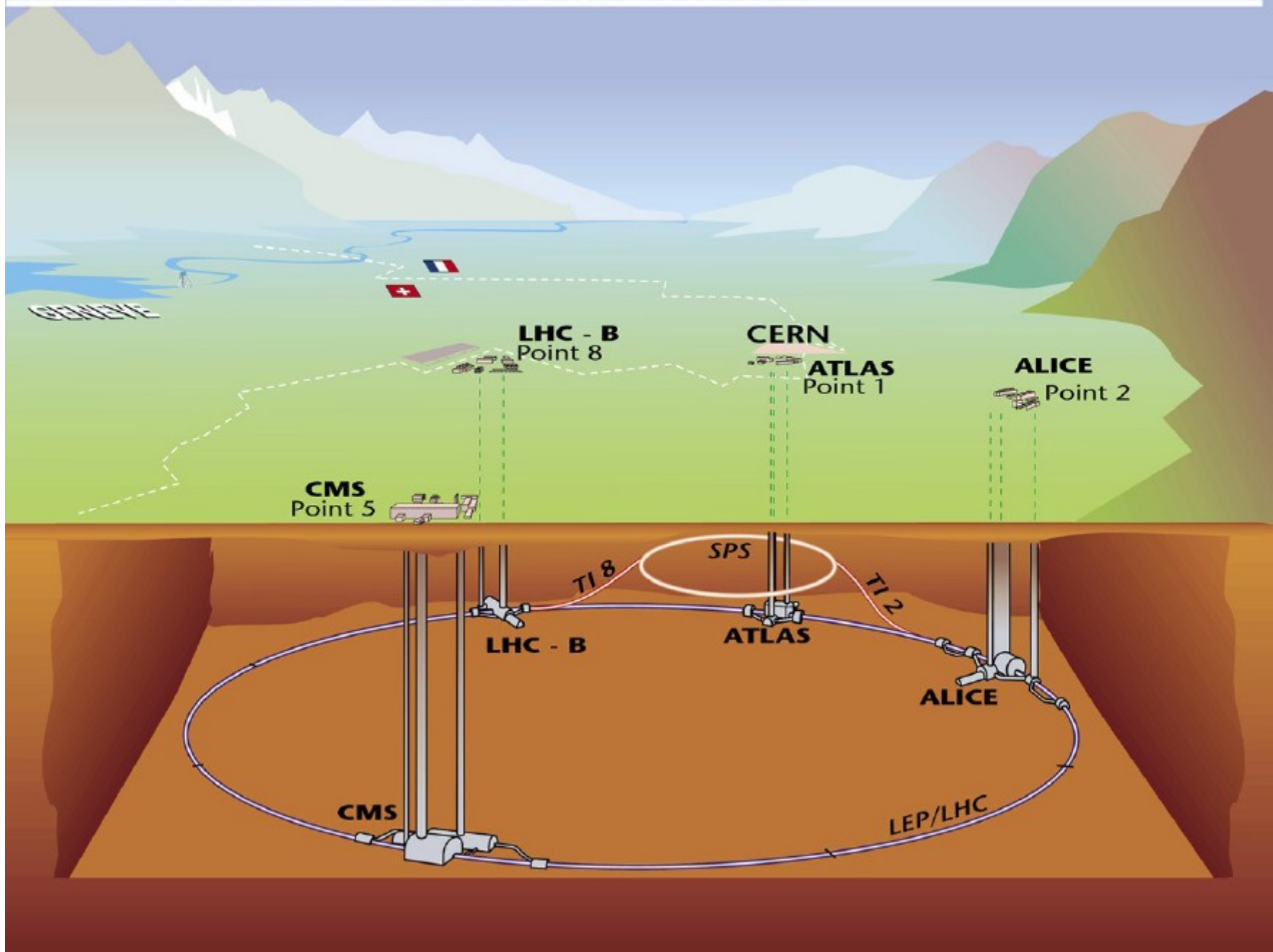

ALICE, ATLAS, and CMS participate in the Pb—Pb program

the ALICE experiment: Schematic

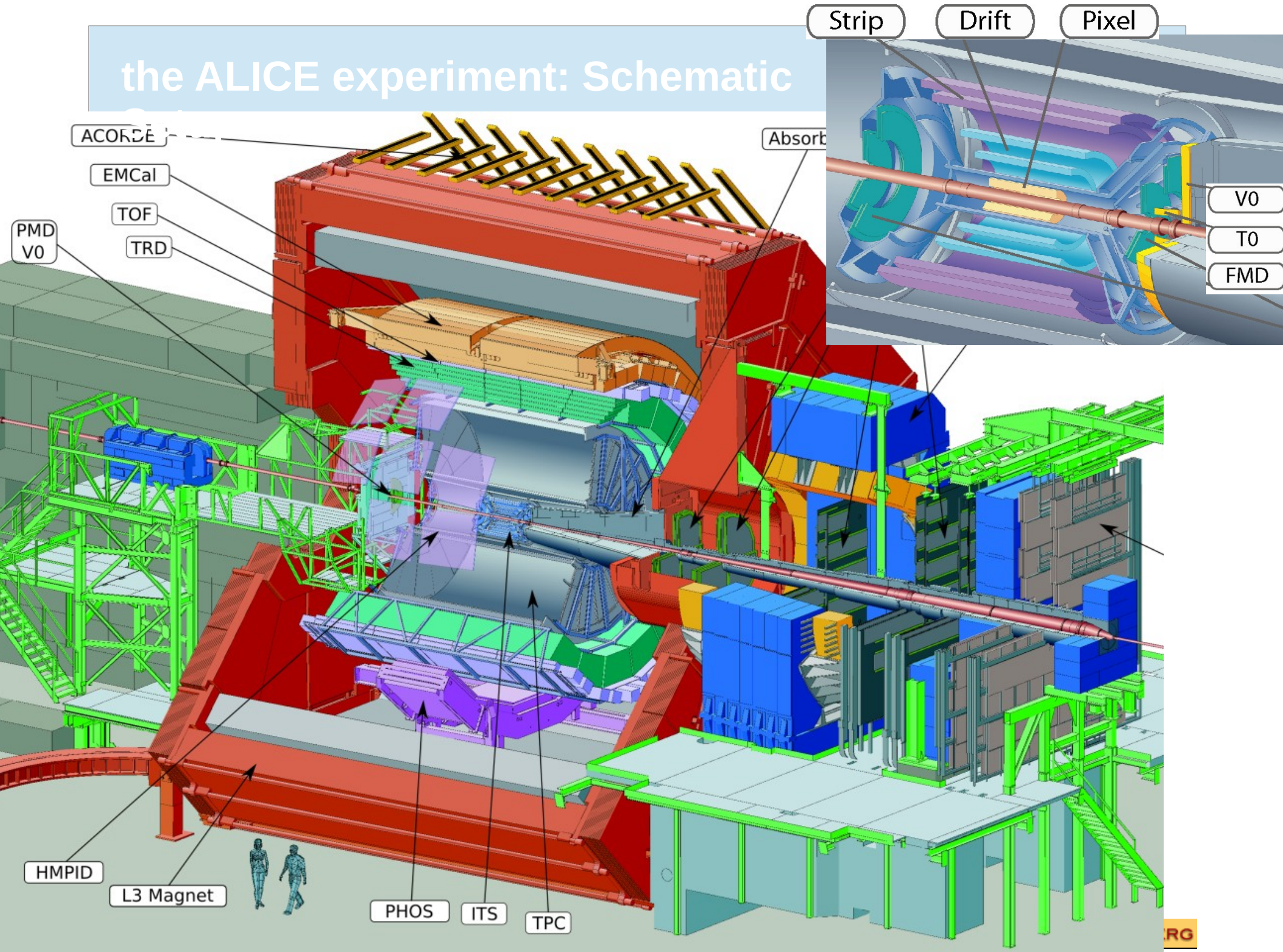

Particle production: full phase space coverage

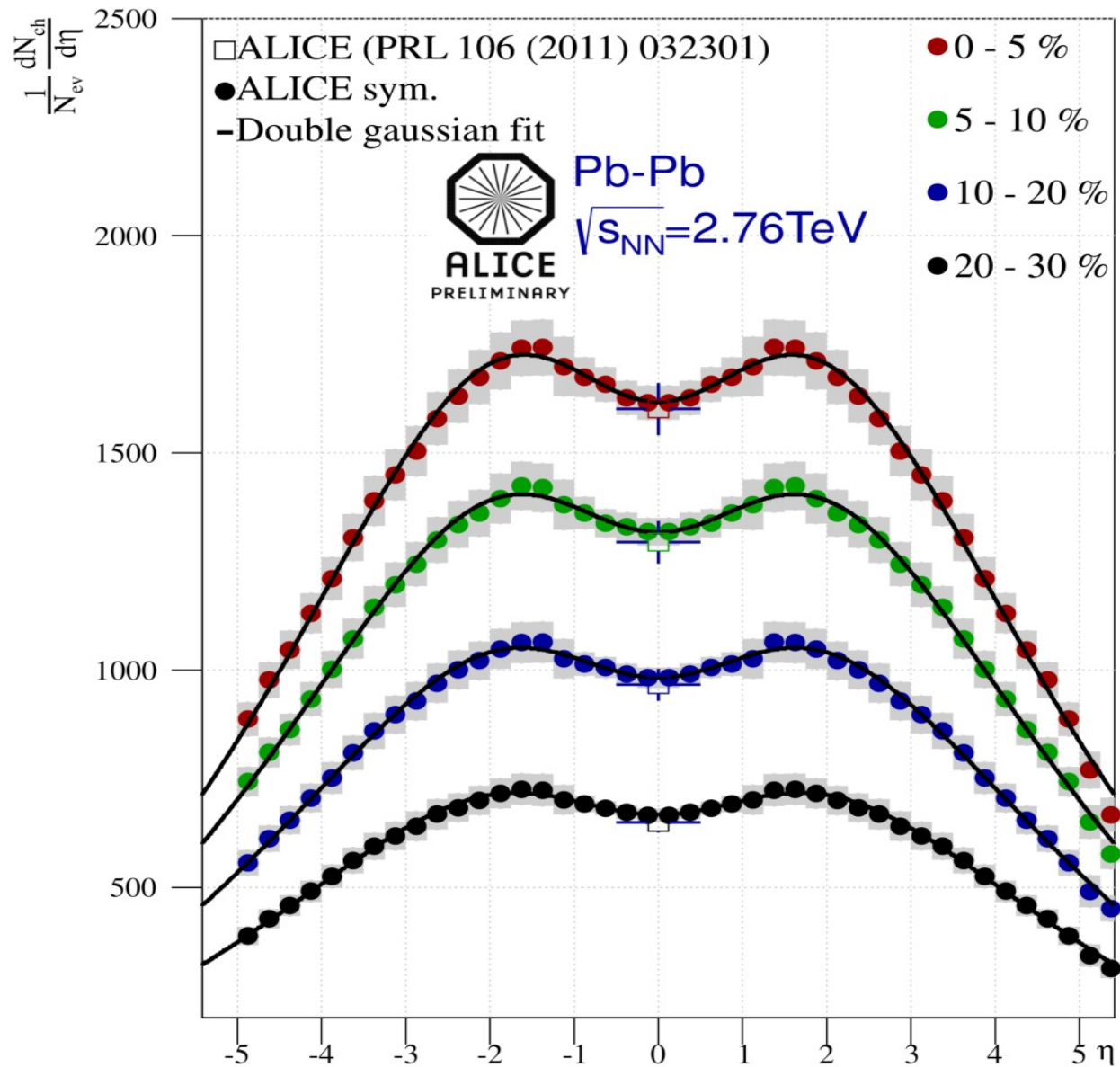

Charged particle multiplicity in pp, pPb and central PbPb collisions

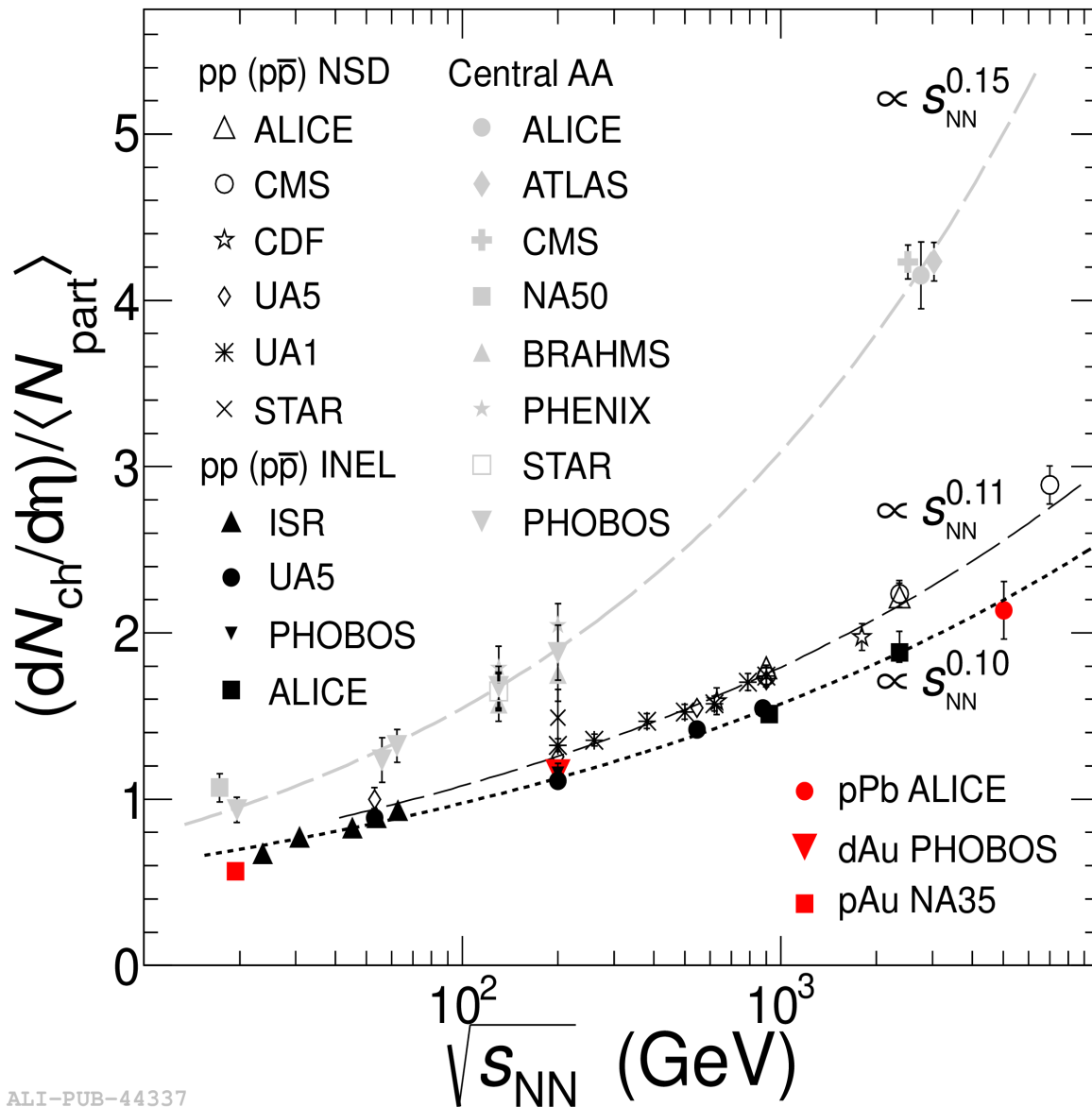

← increase with beam energy significantly steeper than in pp

Fireball at LHC energy has much larger size and lives longer

volume and lifetime
from HBT analysis

fireball volume at
freeze-out is about 5 x
large than volume of a
Pb nucleus

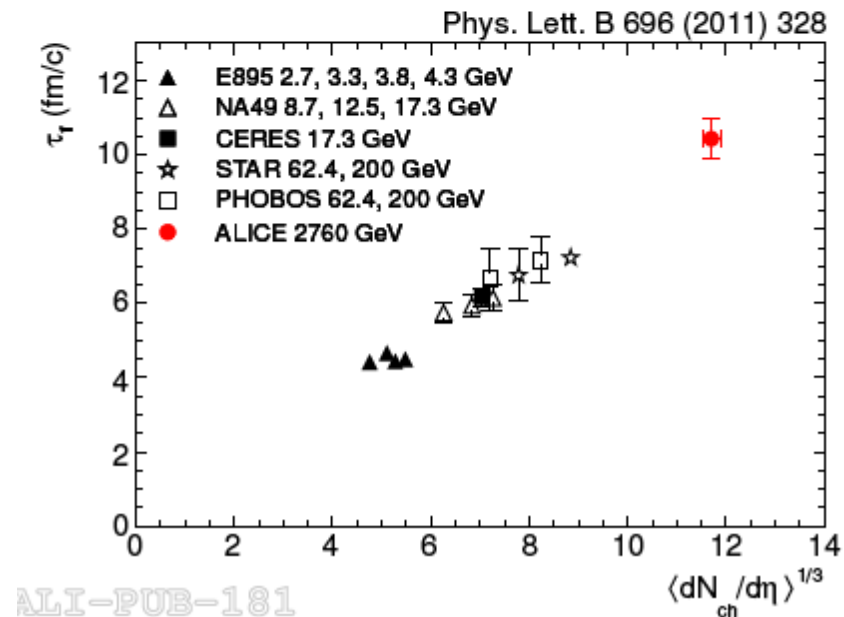
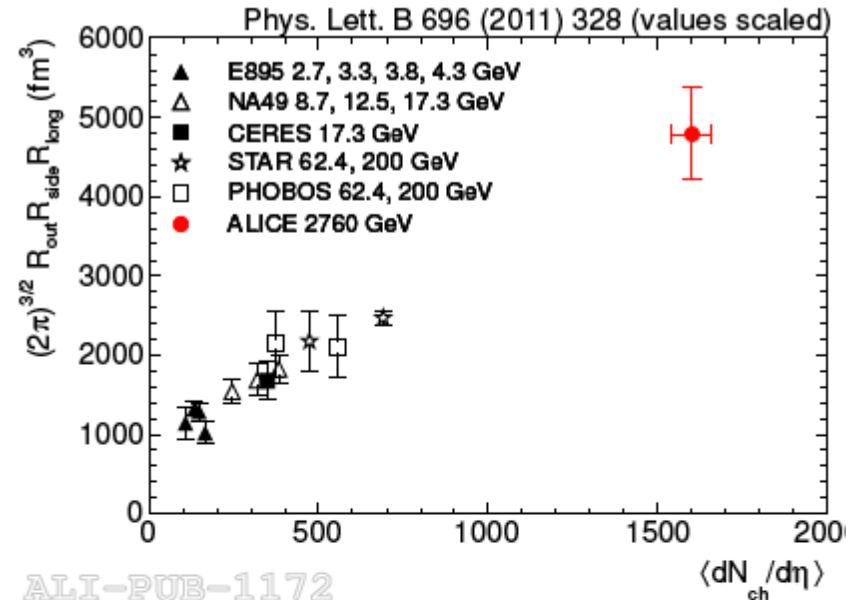

the hot fireball and the QCD phase boundary

Equilibration at the phase boundary

- Statistical model analysis of (u,d,s) hadron production: a test of equilibration of quark matter near the phase boundary
- No (strangeness) equilibration in hadronic phase
- Present understanding: multi-hadron collisions near phase boundary bring hadrons close to equilibrium – supported by success of statistical model analysis

pbm, Stachel, Wetterich,
Phys.Lett. B596 (2004) 61-69

- This implies little energy dependence above RHIC energy
- Analysis of hadron production → determination of T_c

Is this picture also supported by LHC data?

Example: RHIC lower energies, STAR data alone

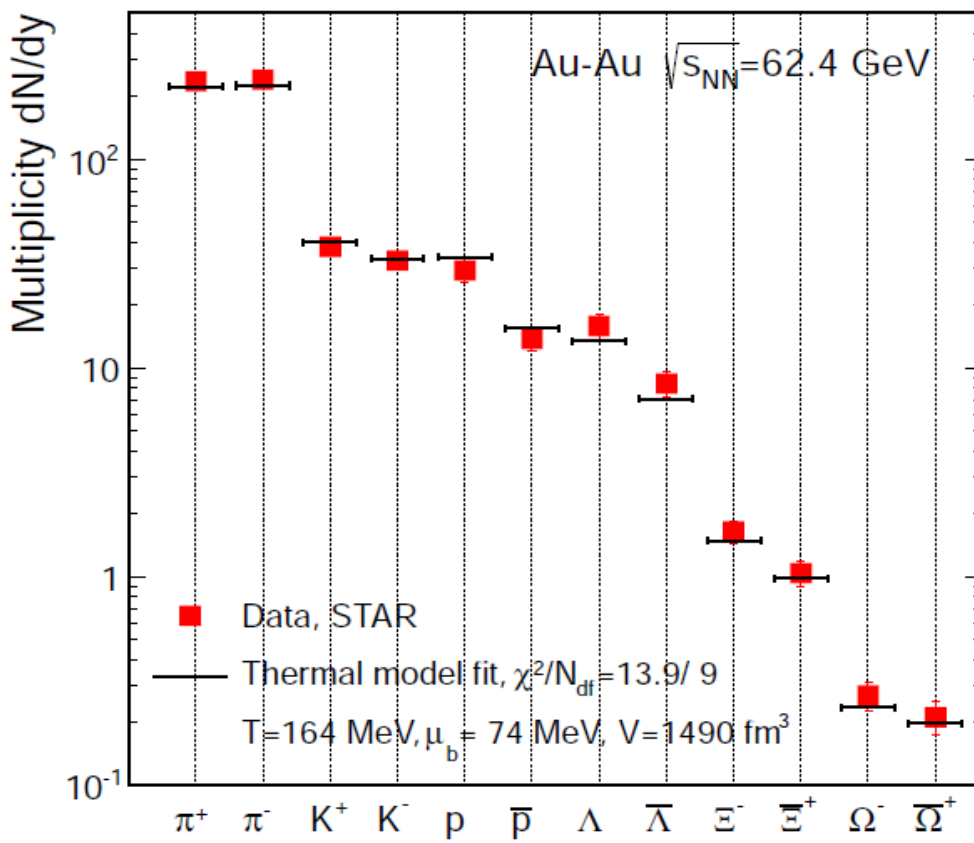
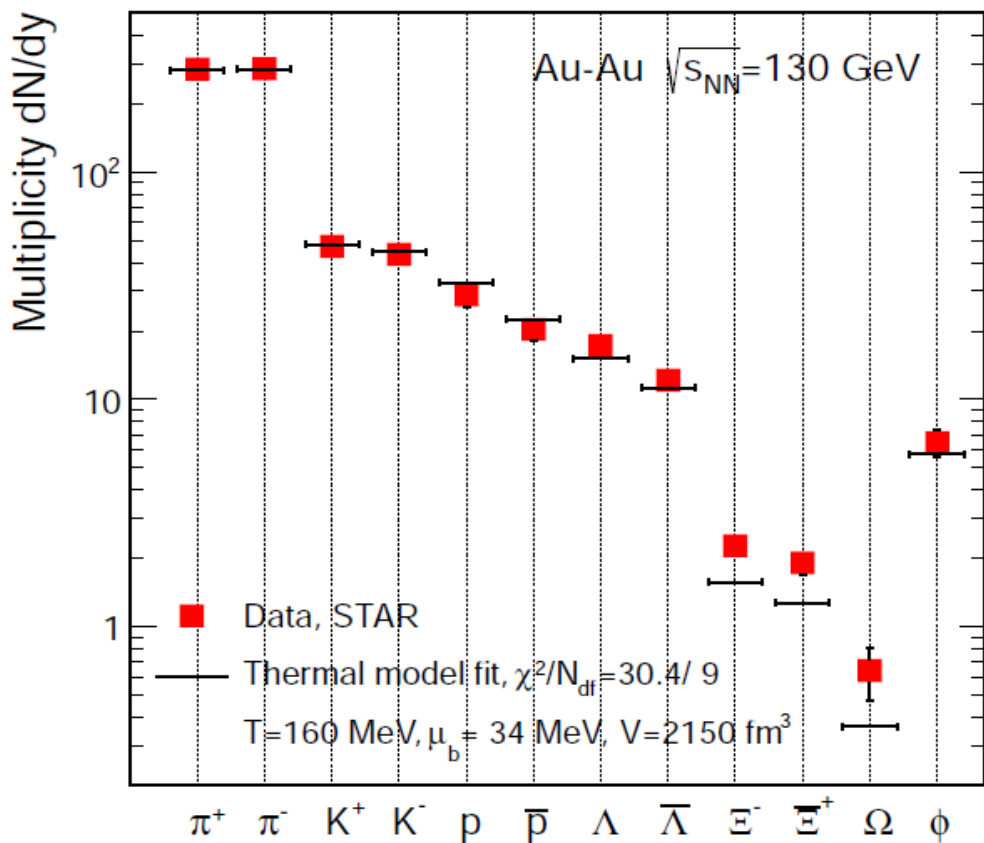

reasonable fits, $T = 160 - 164$ MeV

Parameterization of all freeze-out points before LHC data

note: establishment of limiting temperature

$$T_{\text{lim}} = 164 \pm 4 \text{ MeV}$$

get T and μ_B for all energies

for LHC predictions
we picked $T = 164 \text{ MeV}$

A. Andronic, pbm, J. Stachel,
Nucl. Phys. A772 (2006) 167
nucl-th/0511071

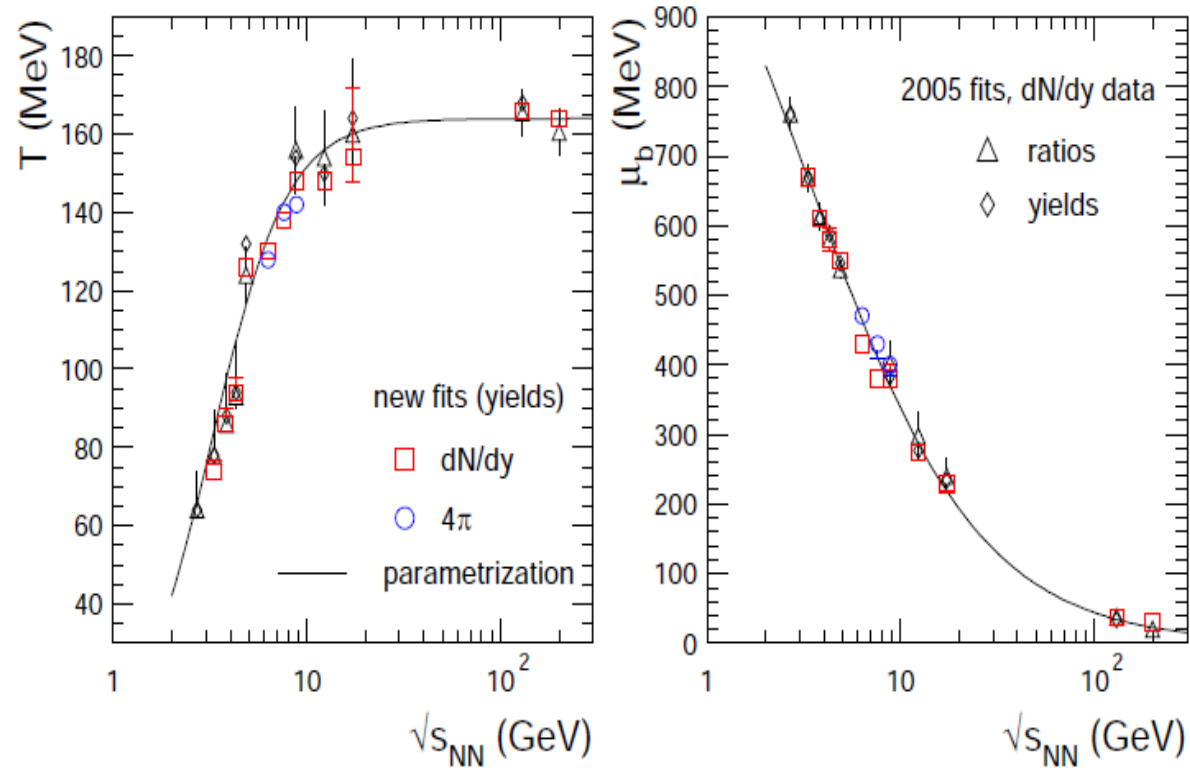

overall systematics, including ALICE data, on proton/pion and kaon/pion ratios

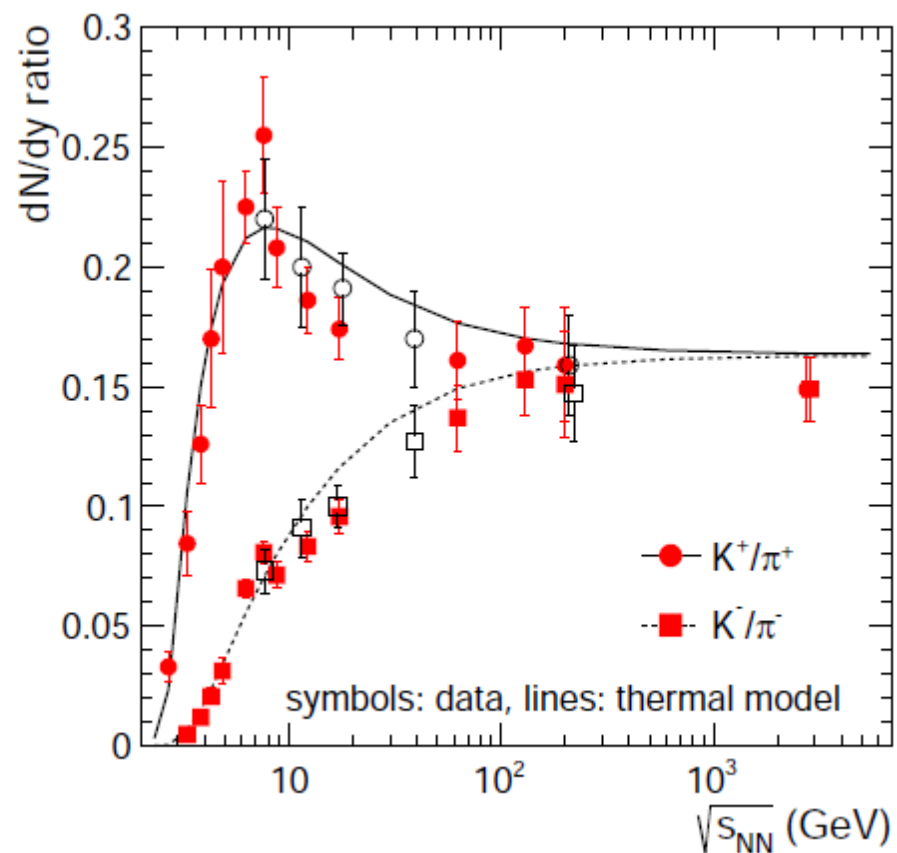
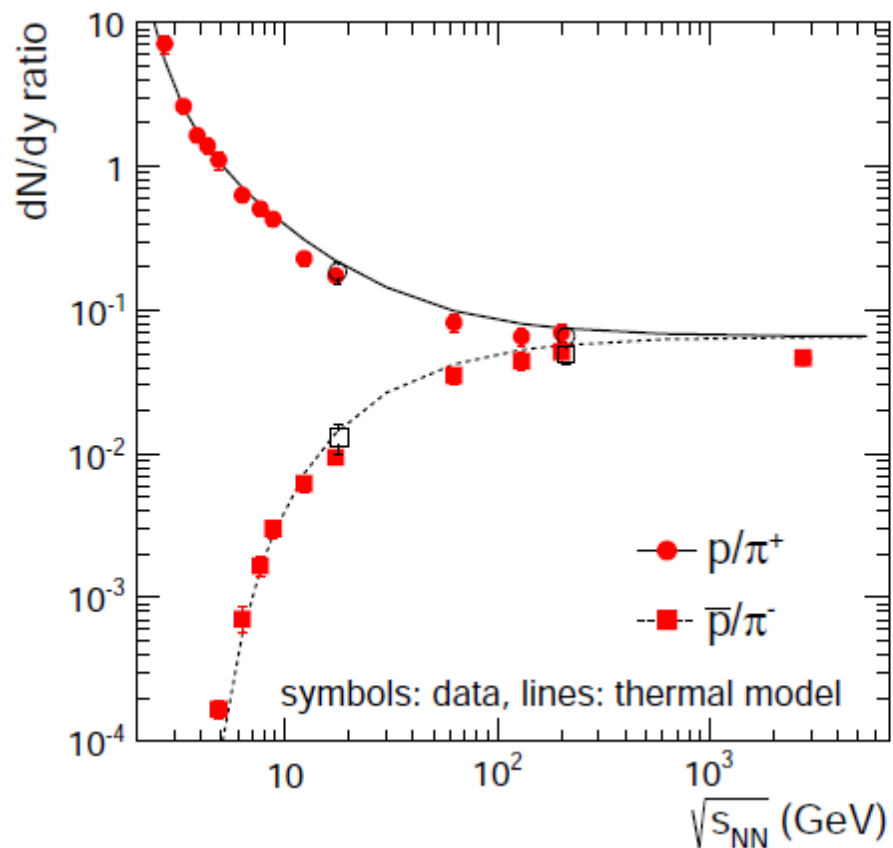

New fit of Alice data including hyperons and light nuclei

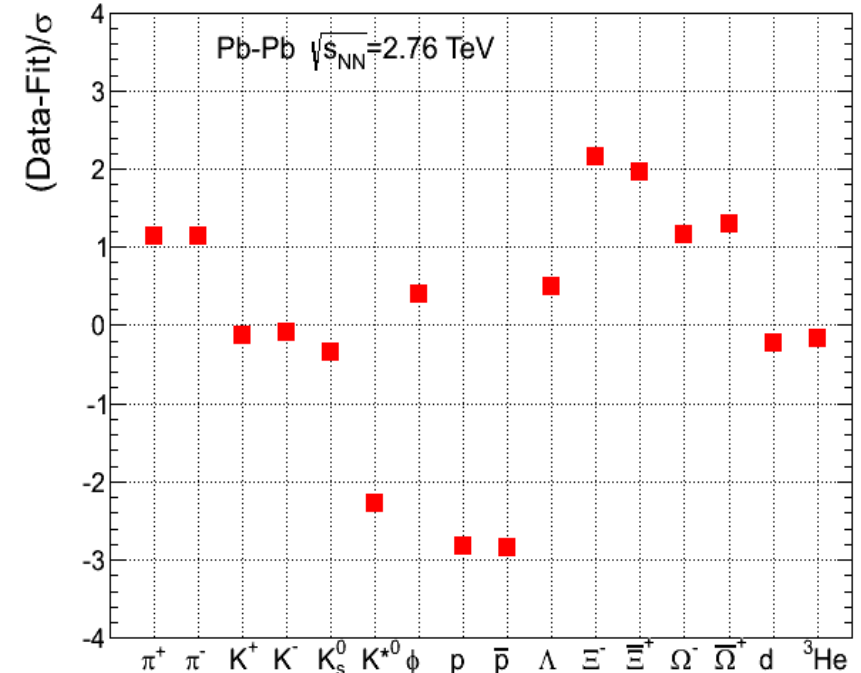
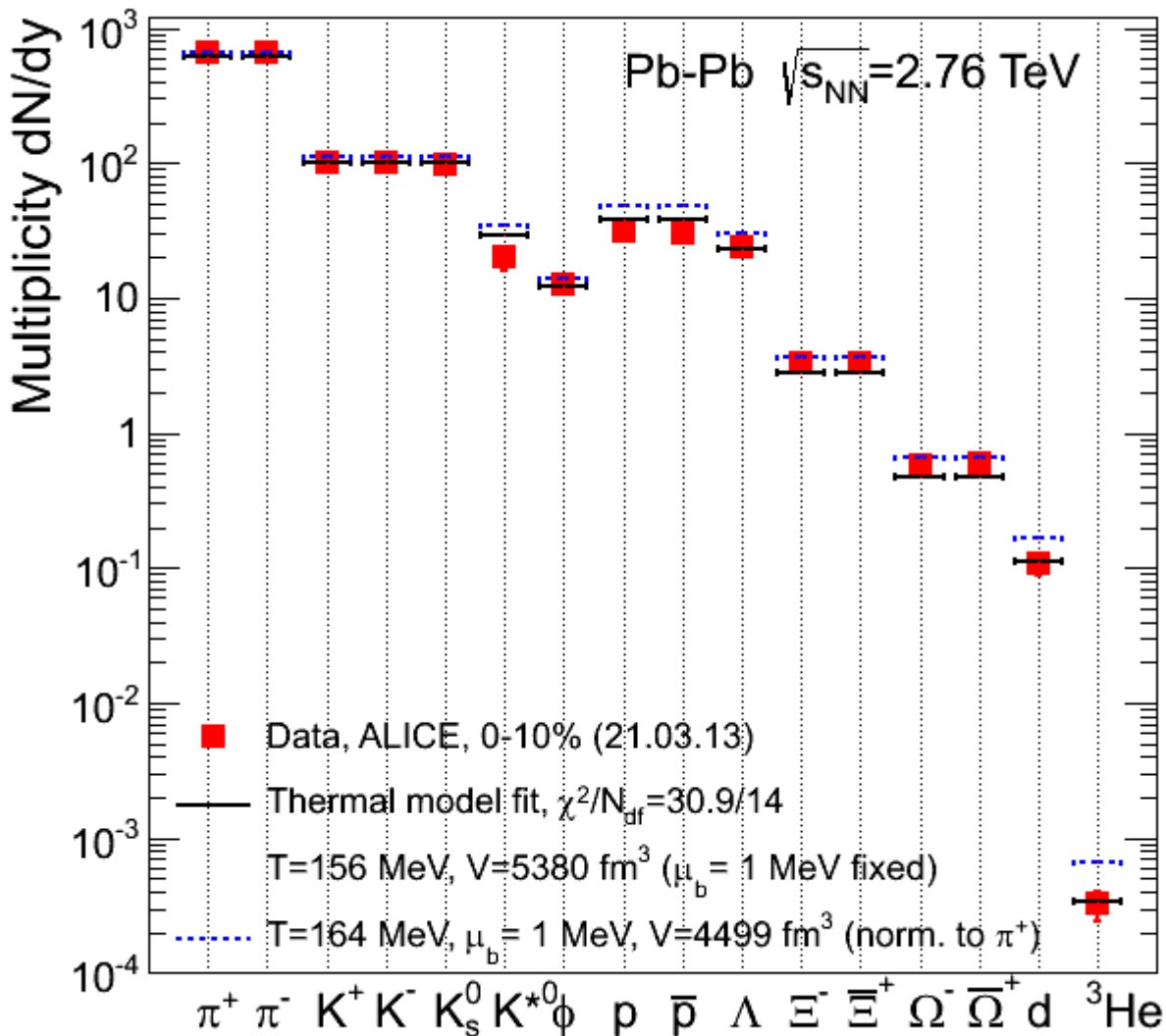

hot off the press and preliminary

$T = 156$ MeV produces quite a good fit to all data!

summary

- energy dependence of (u,d,s) hadron production well understood
- limiting temperature reflects phase boundary
- critical temperature close to 155 +/- 8 MeV

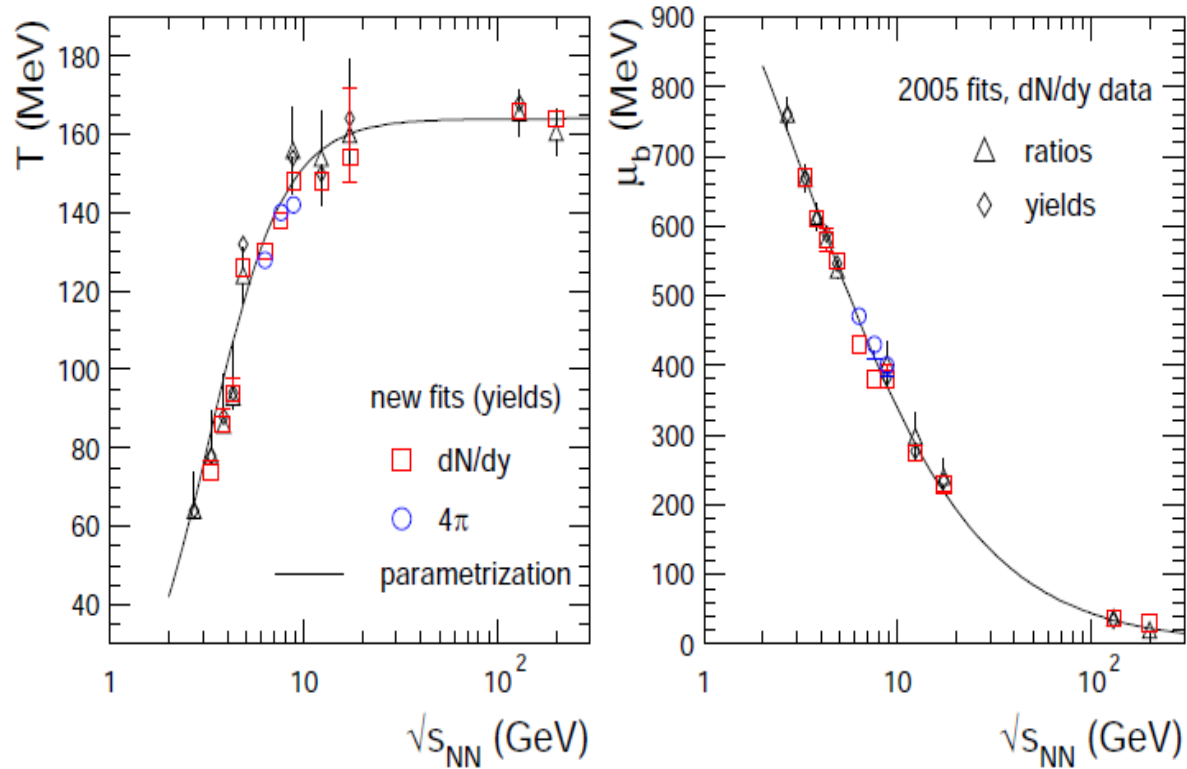

Is there a critical point in the QCD phase diagram?

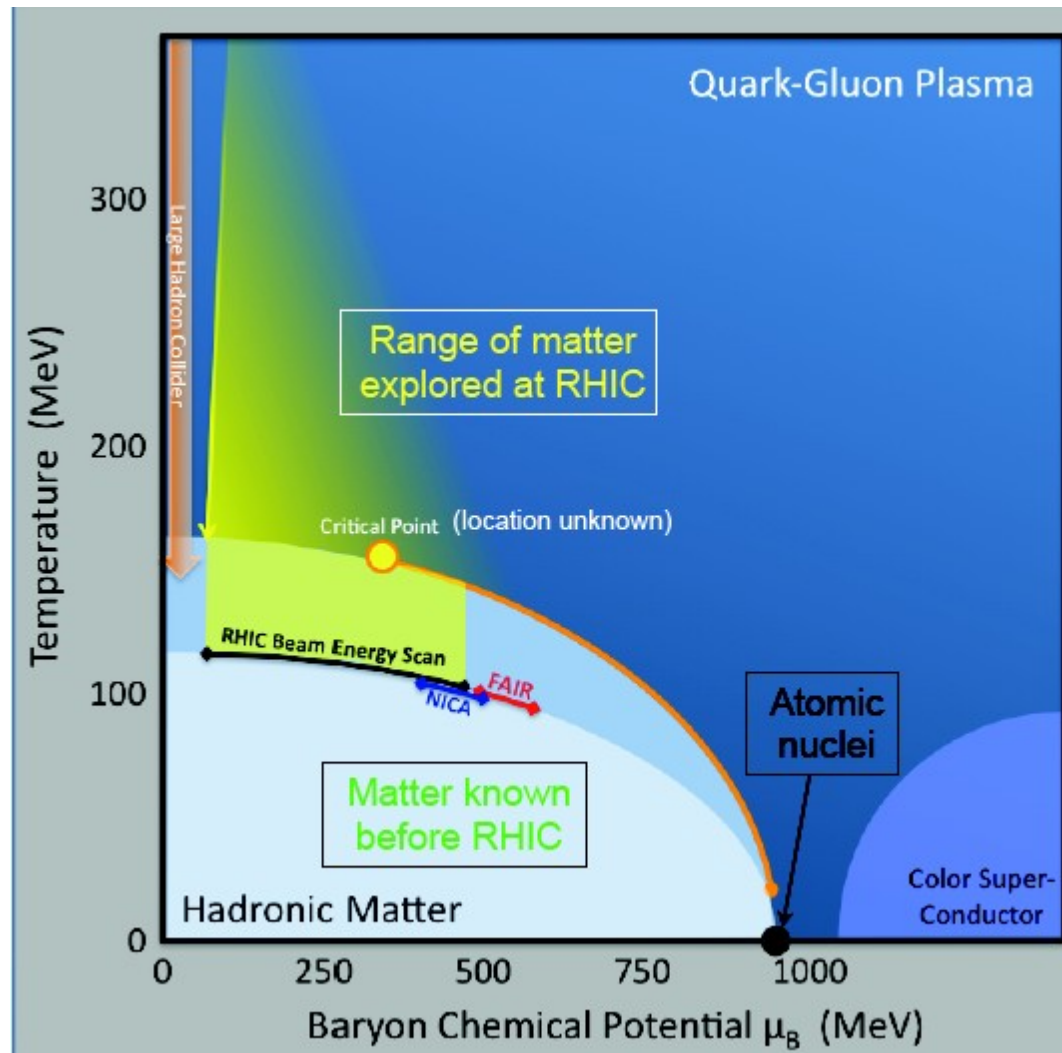

Picture from B. Mueller

higher moments of net-baryon distributions

STAR Beam Energy Scan

no striking energy dependence visible

very difficult event-by-event corrections

no evidence for critical point in the phase diagram

look for precision studies in RHIC BES-II

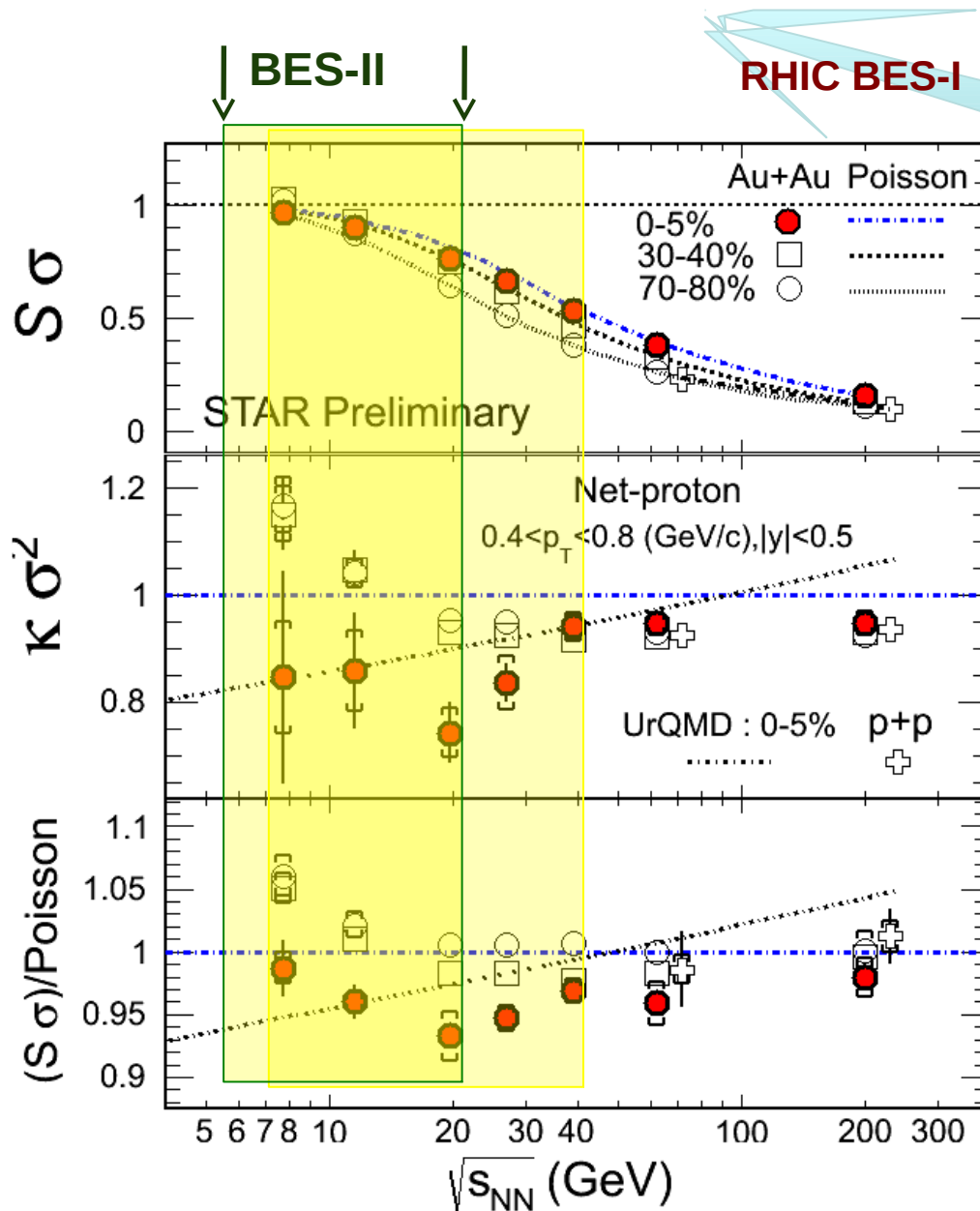

hydrodynamic expansion of fireball

fireball expands collectively like an ideal fluid

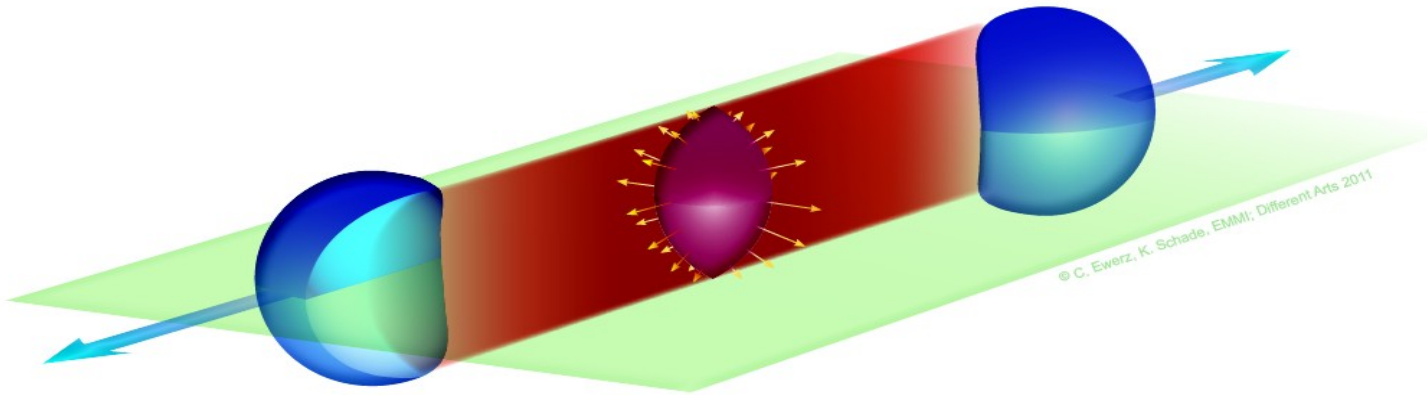

momentum space

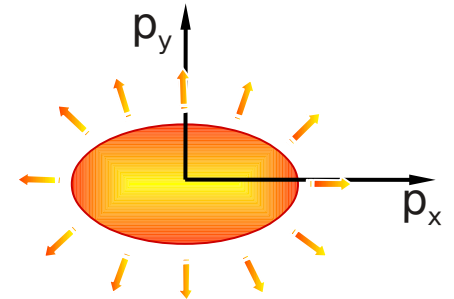

$$dN/d\phi = 1 + 2 V_2 \cos 2 (\phi - \psi) + \dots$$

hydrodynamic flow characterized by azimuthal anisotropy coefficient V_2
+ higher orders

Elliptic Flow in PbPb Collisions at $\sqrt{s_{NN}} = 2.76$ TeV

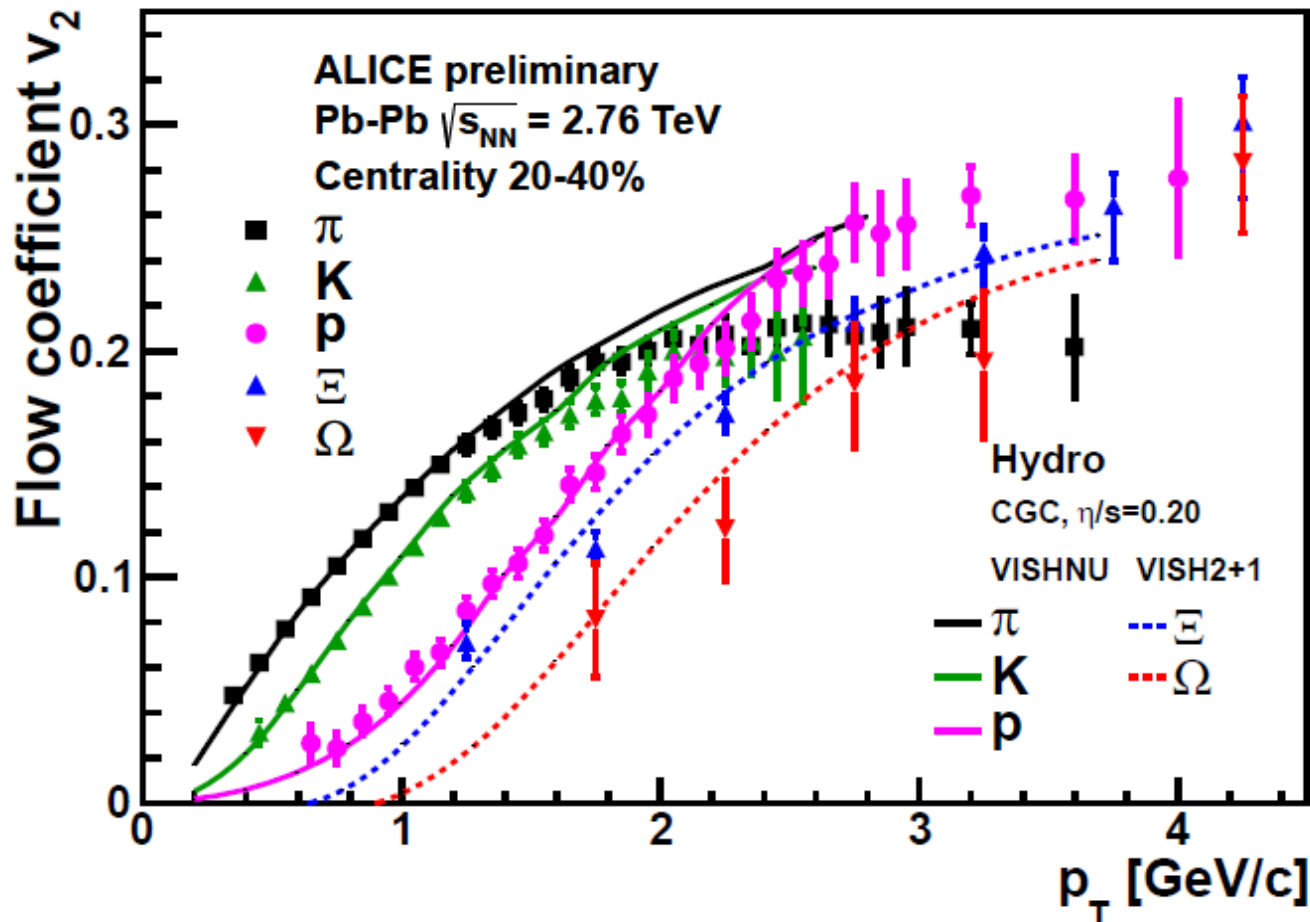

rapidly rising v_2 with p_t and mass ordering are typical features of hydrodyn. expansion
nearly ideal (non-dissipative) hydrodynamics reproduces data, system fairly strongly coupled

The 2-particle correlation function – higher moments

ALICE, PRL 107 (2011) 032301

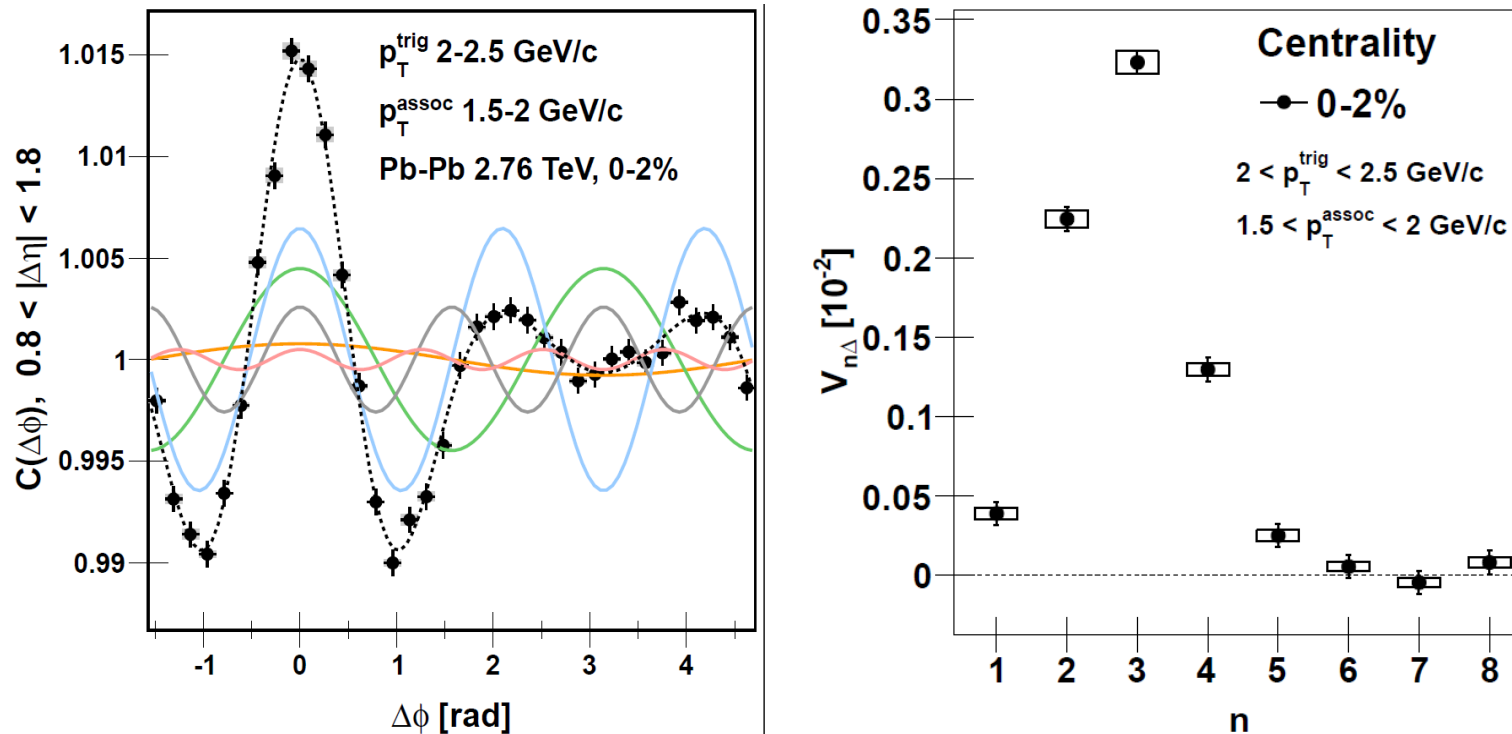

measurement of the first 8 harmonic coefficients
 v_1 - v_5 significantly larger than 0, maximum at v_3

current understanding: higher harmonics (3,4,5,...) are due to initial inhomogeneities caused by granularity of binary parton-parton collisions

Analogy with early universe power spectrum of CMB

Introducing initial quantum fluctuations into calculation

B. Schenke, QM2012

Given the initial energy density distribution we solve

$$\partial_\mu T^{\mu\nu} = 0$$

$$T^{\mu\nu} = (\epsilon + P)u^\mu u^\nu - P g^{\mu\nu} + \pi^{\mu\nu}$$

using only shear viscosity: $\pi_\mu^\mu = 0$

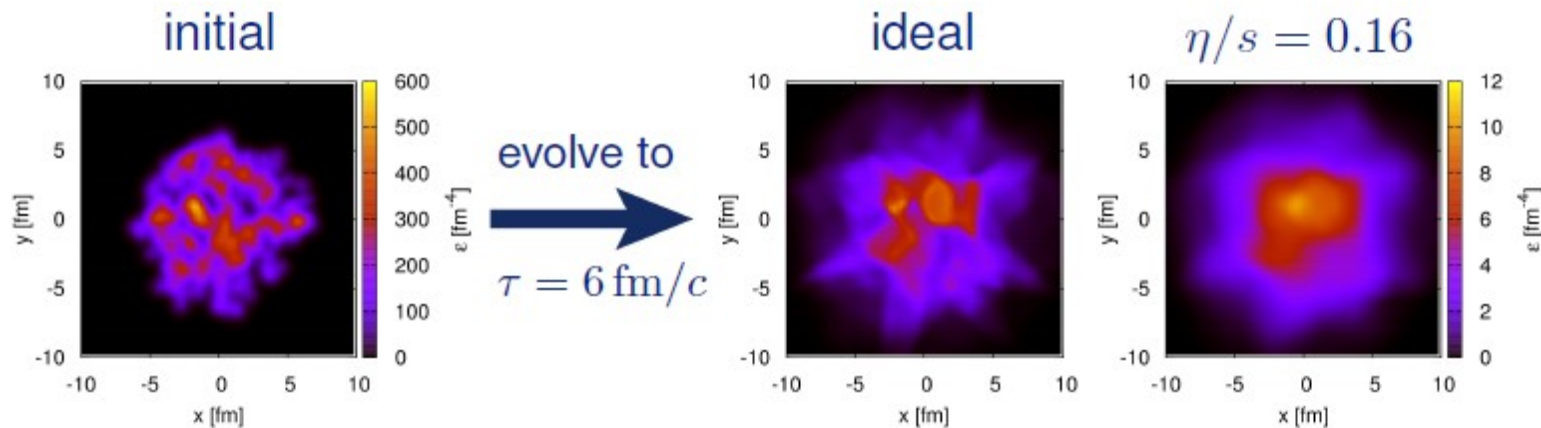

Note: alternate means to determine η/s

Energy density B.Schenke, P.Tribedy, R.Venugopalan, Phys.Rev.Lett. 108, 252301 (2012)

Solve for gauge fields after the collision in the forward lightcone

Compute energy density in the fields at $\tau = 0$ and later times with CYM evolution

Lattice: Krasnitz, Venugopalan, Nucl.Phys. B557 (1999) 237

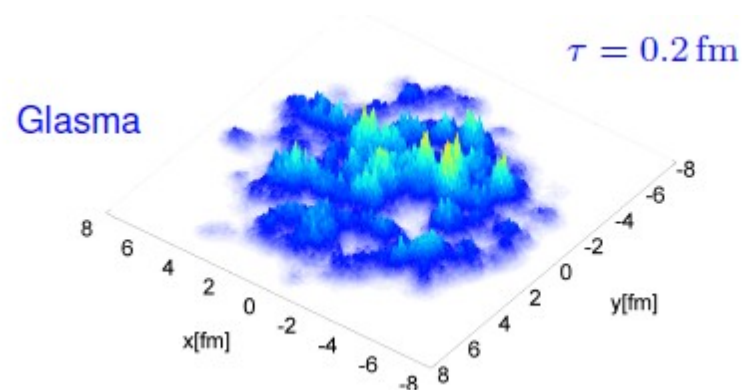
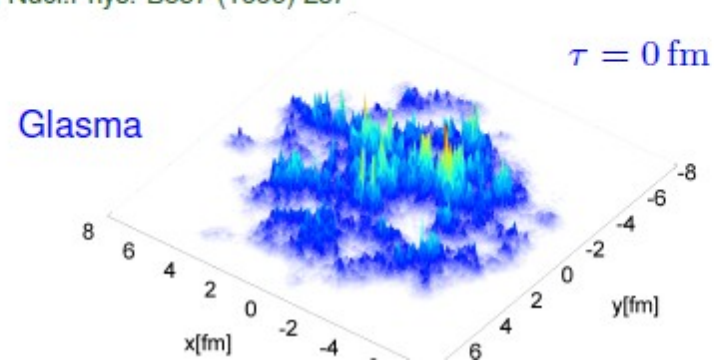

Quantitative description of ATLAS and ALICE data

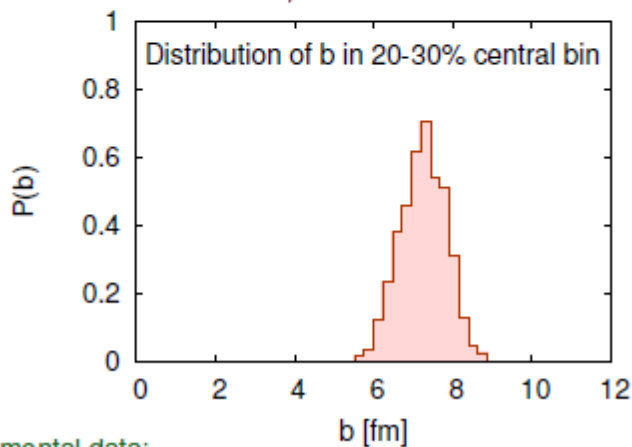
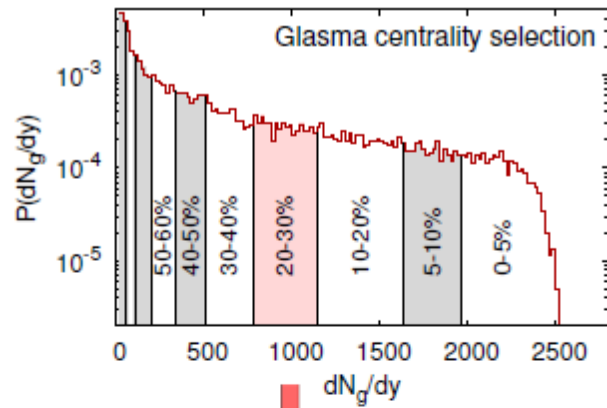

Experimental data:
 ATLAS collaboration, Phys. Rev. C 86, 014907 (2012)
 ALICE collaboration, Phys. Rev. Lett. 107, 032301 (2011)

Hydro evolution
 MUSIC

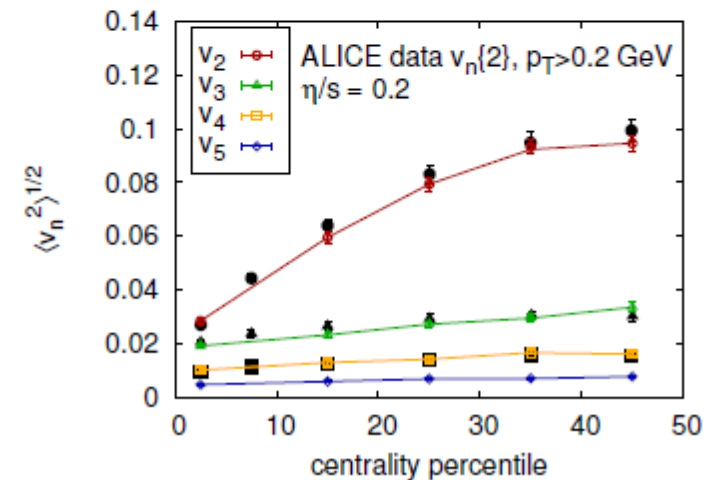
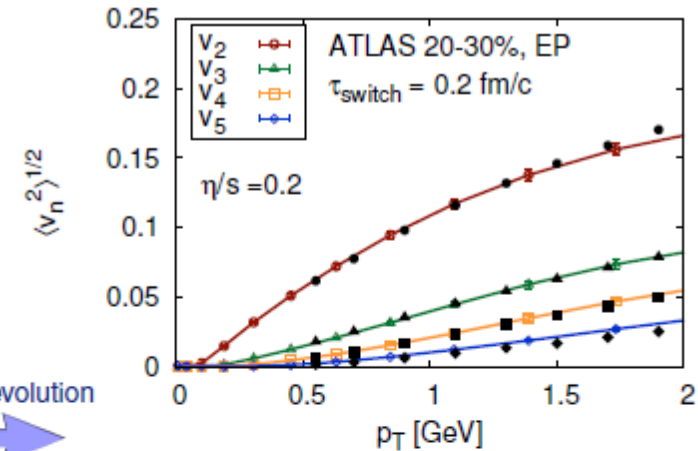

calc.: B. Schenke et al., QM2012, $\eta/s = 0.2$

Results from RHIC

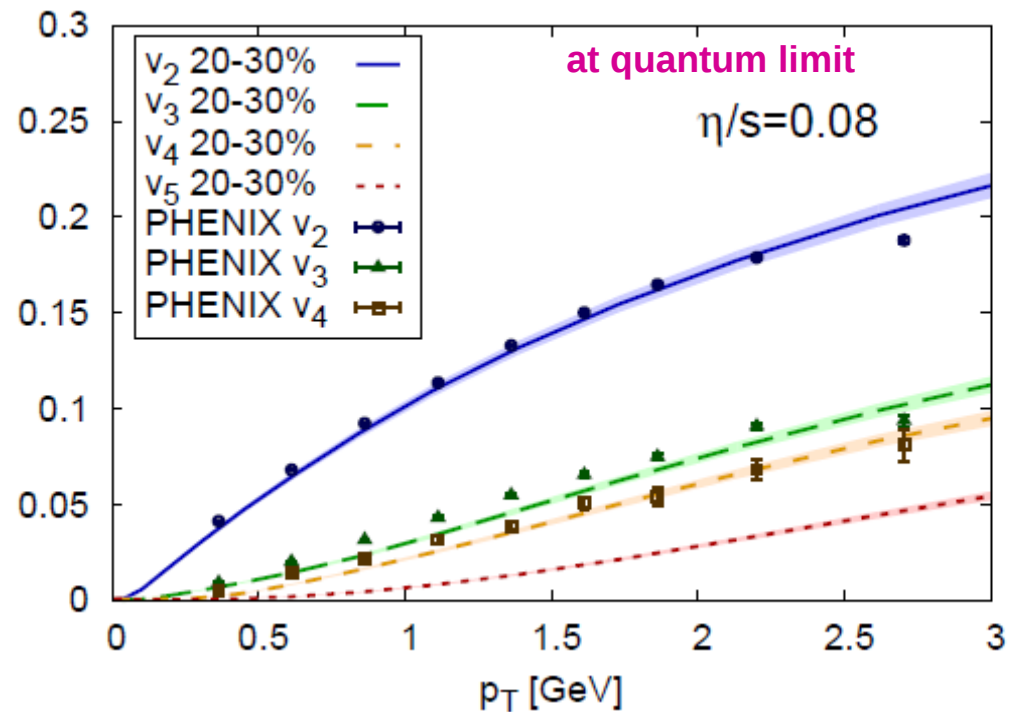
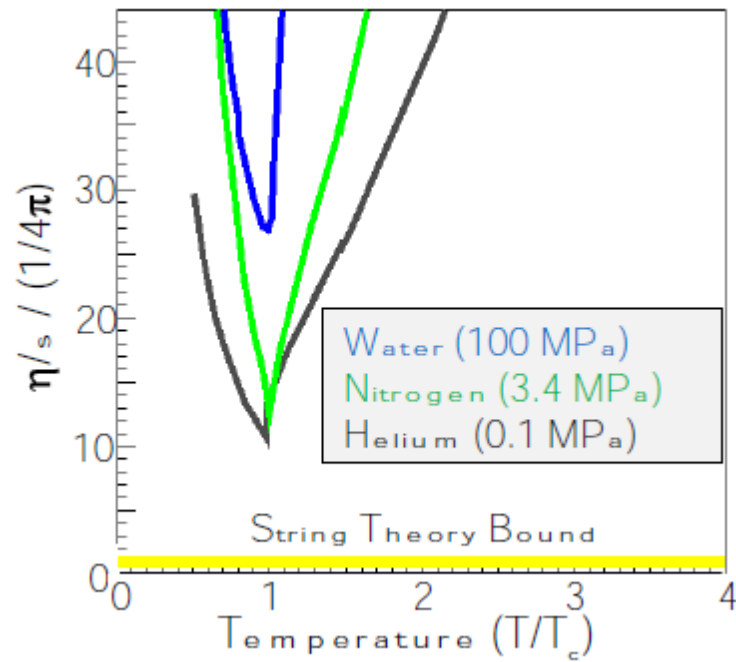

**New LHC results strikingly confirm RHIC picture of the QGP
as a nearly ideal fluid**

The hot fireball emits thermal photons from the QGP

PHENIX and ALICE results

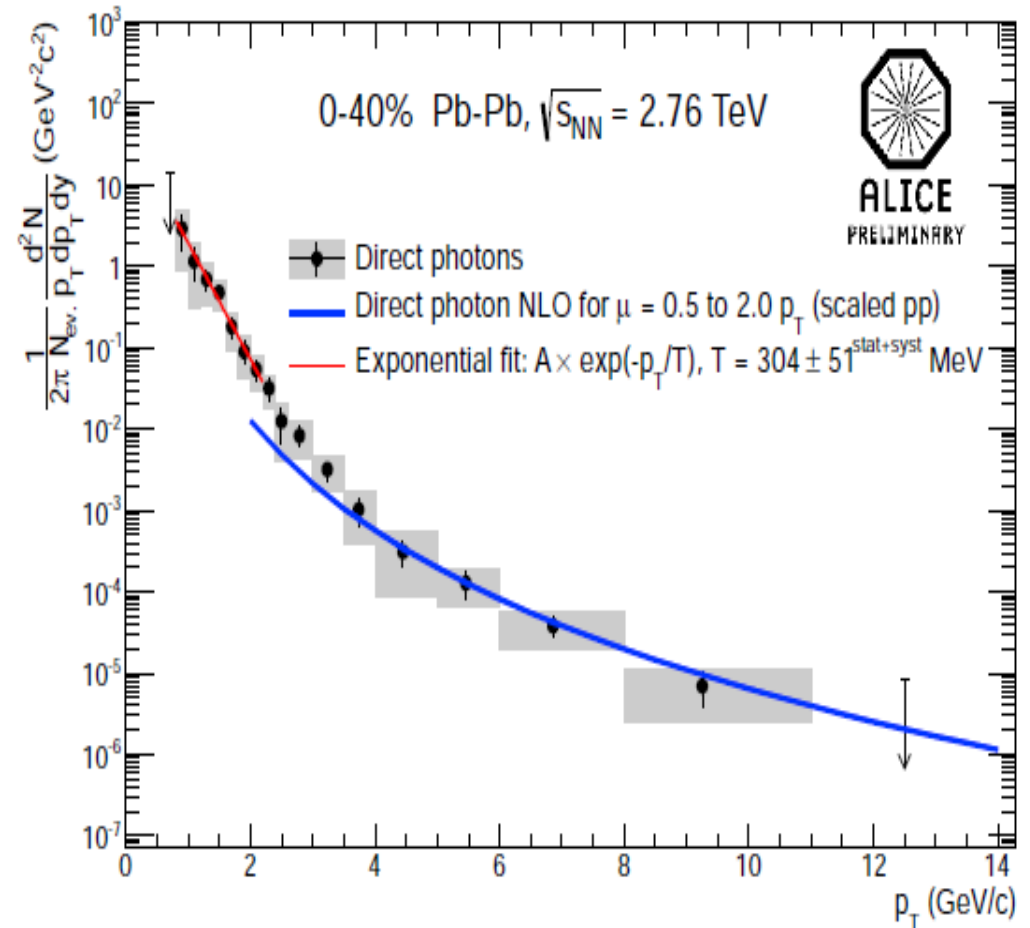
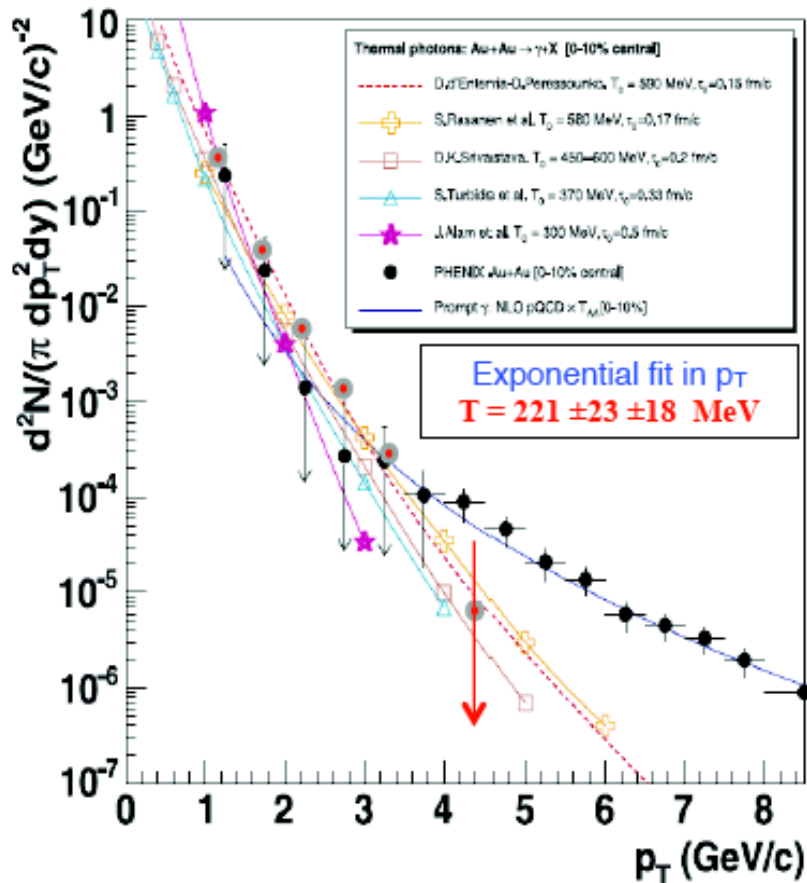

at LHC $T_{ini}(\text{fireball}) > 400$ MeV = $2.5 \times T_c$

average $T = 304 \pm 51$ MeV
 temperature

highest ever measured

hard probes at RHIC and the LHC

$$R_{AA} = \text{medium/vacuum}$$

$R_{AA} = 1$ if no dense medium is formed

or

if one looks at electro-weak probes

Nuclear Modification Factor

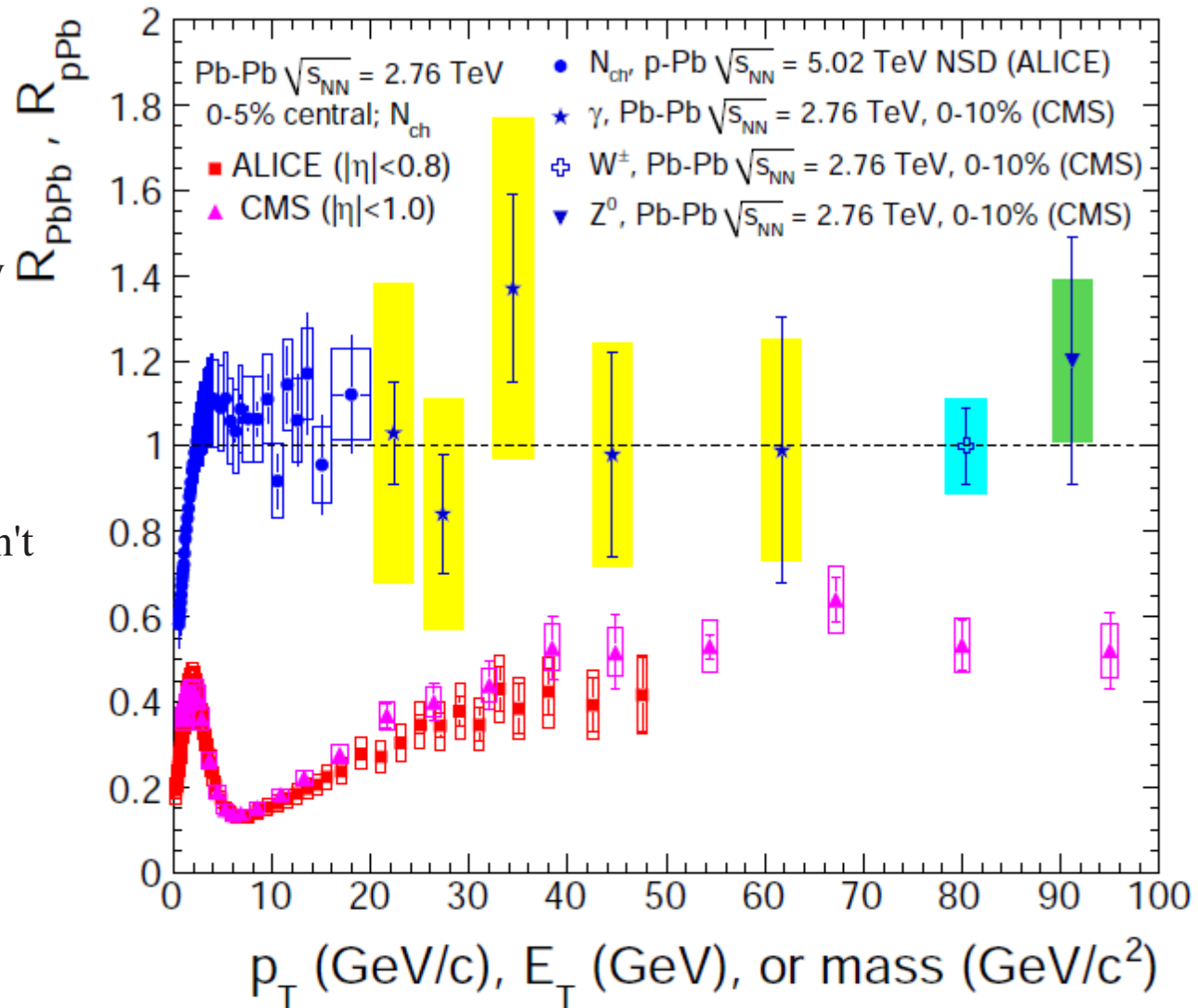

Hot off the press: p-Pb collisions from LHC vs d-Au collisions from RHIC

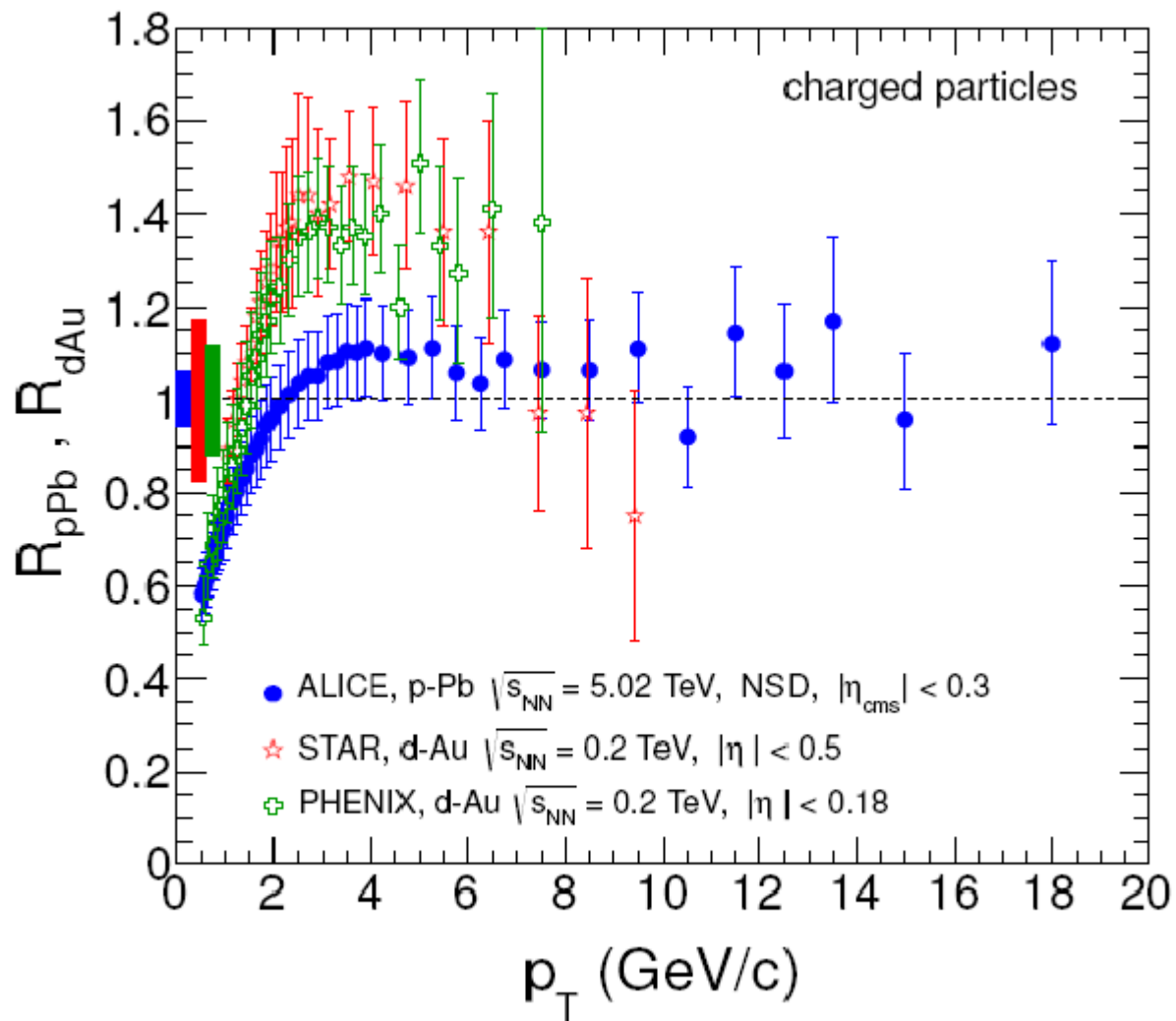

$R_{AA} = 1$ for pPb collisions at LHC ($p_T > 3$ GeV)

Jet quenching at the LHC

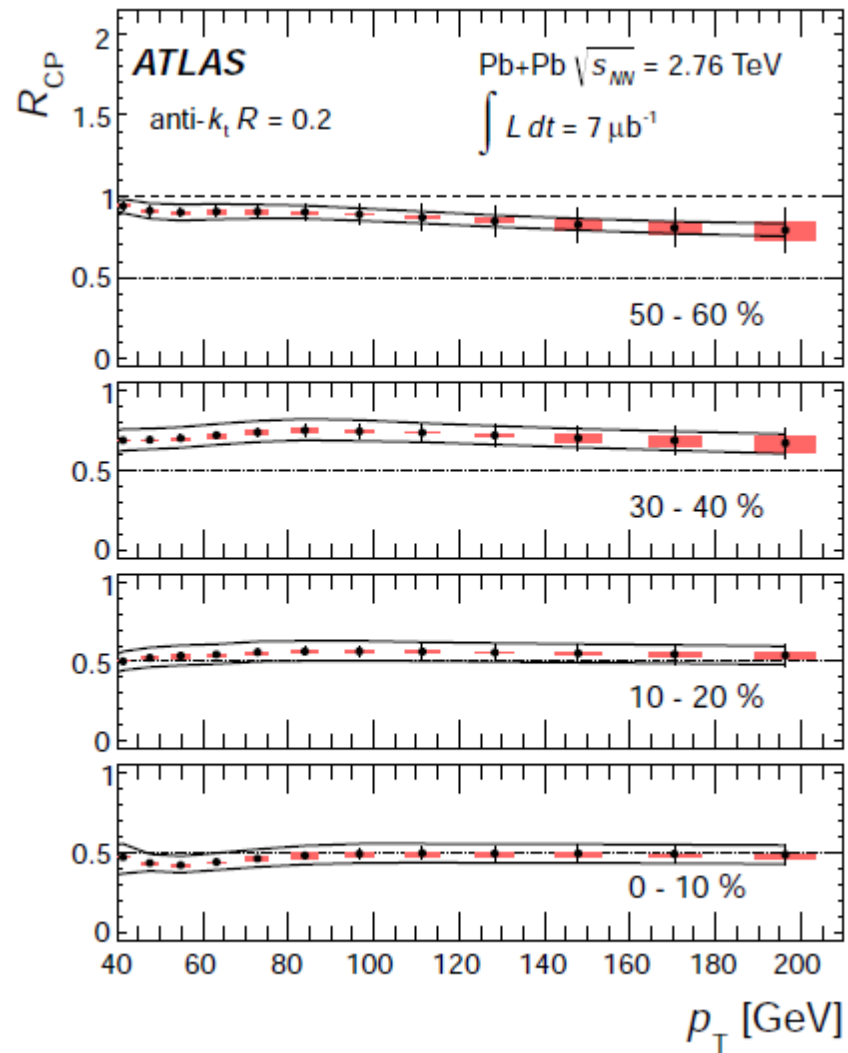

R_AA never reaches unity

summary, high p_t and jet phenomena

- hadron production in Pb—Pb at high p_t is strongly suppressed compared to collision scaling from pp, even up to 100 GeV
- jets are quenched up to 300 GeV
- pQCD is not reached at asymptotically high p_t values
- the fireball is dense enough to affect high p_t partons but not as dense as presumed in AdS/CFT scenarios

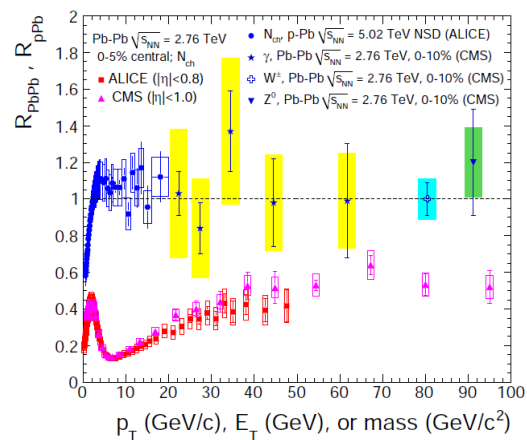

Charmonium as a probe for the properties of the QGP

the original idea: (Matsui and Satz 1986) implant charmonia into the QGP and observe their modification, in terms of suppressed production in nucleus-nucleus collisions with or without plasma formation – **sequential melting**

new insight (pbn, Stachel 2000) QGP screens all charmonia, but charmonium production takes place at the phase boundary, enhanced production at colliders – **signal for deconfined, thermalized charm quarks**

recent reviews: L. Kluberg and H. Satz, arXiv:0901.3831

pbn and J. Stachel, arXiv:0901.2500

both published in Landoldt-Boernstein Review, R. Stock, editor, Springer 2010

work reported here
done in coll. with
Anton Andronic
Krzysztof Redlich
Johanna Stachel

quarkonium as a probe for deconfinement at the LHC

the statistical (re-)generation picture

P. Braun-Munzinger, J. Stachel, The Quest for the Quark-Gluon Plasma, Nature 448 Issue 7151, (2007) 302-309.

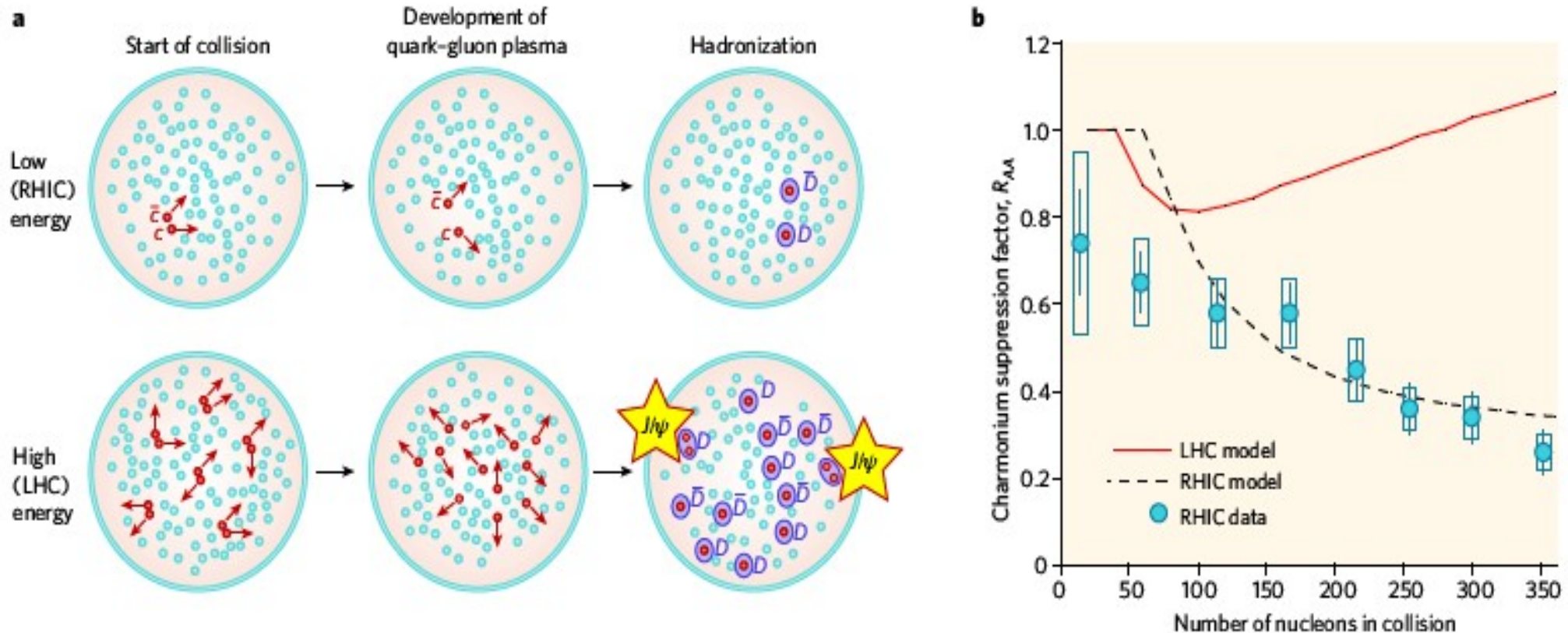

charmonium enhancement as fingerprint of color screening and deconfinement at LHC energy

pbm, Stachel, Phys. Lett. B490 (2000) 196

Andronic, pbm, Redlich, Stachel, Phys. Lett. B652 (2007) 659

decision on regeneration vs sequential suppression from LHC data

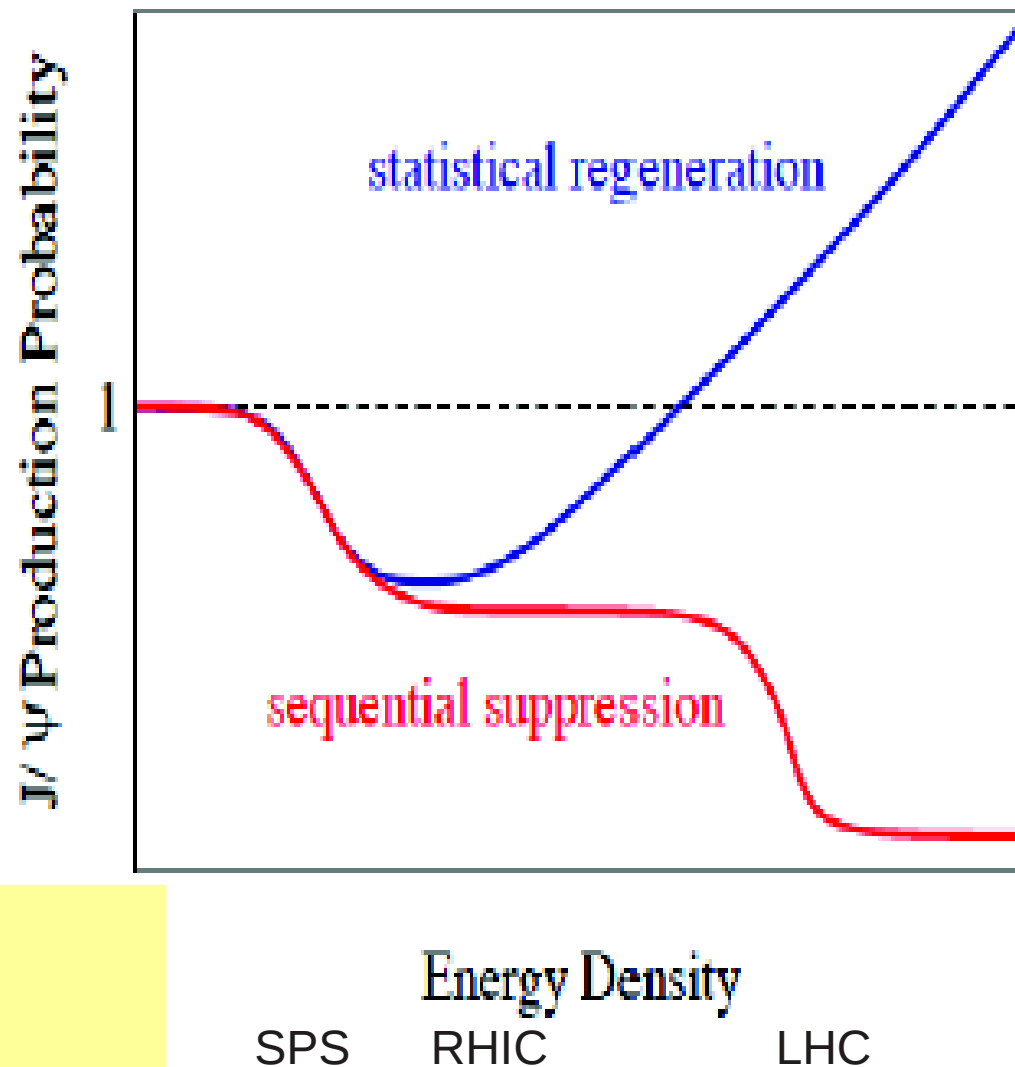

Picture:
H. Satz 2009

less suppression when increasing the energy density

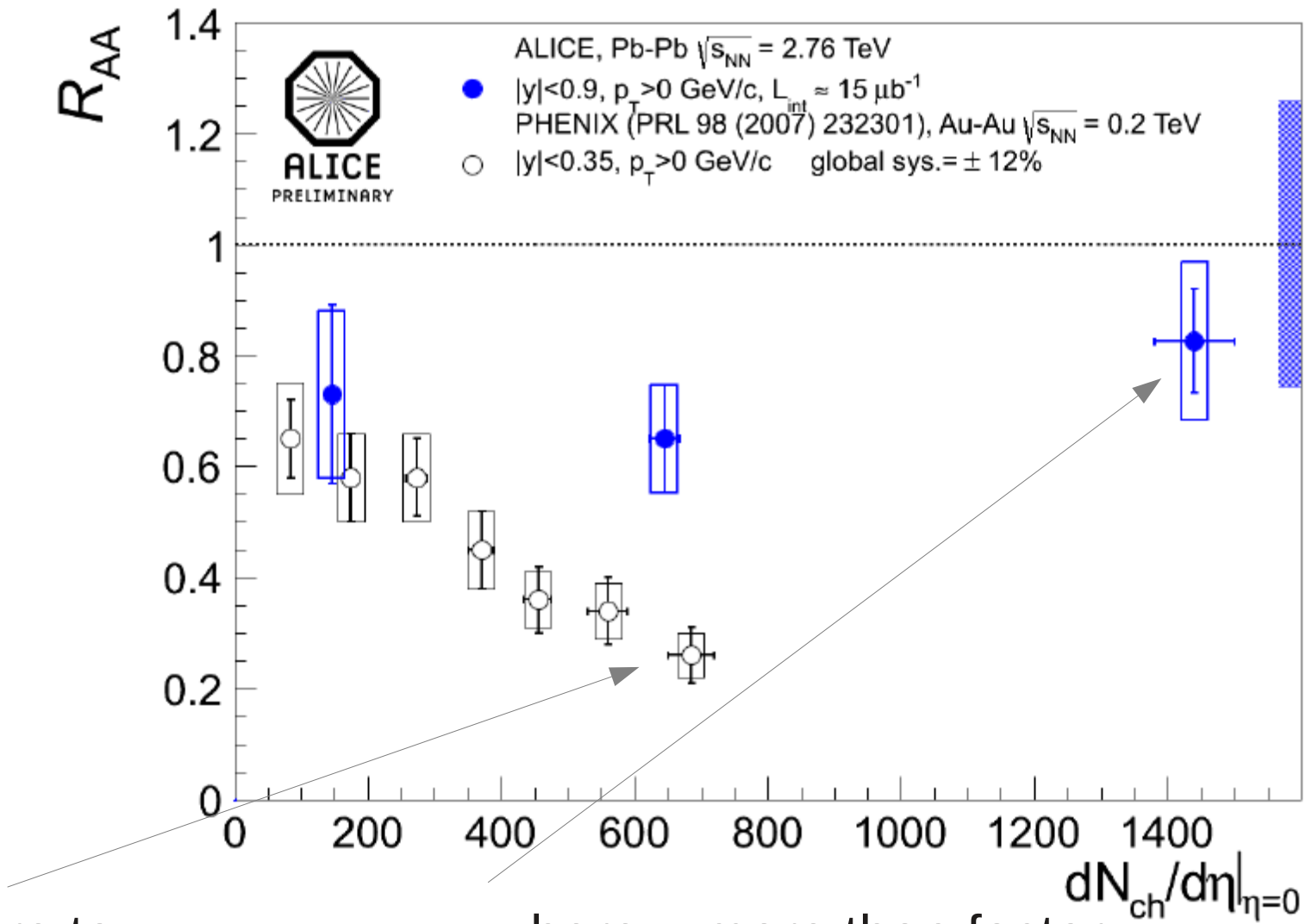

from here to here more than factor of 2 increase in energy density, but R_{AA} increases by more than a factor of 3

main ALICE results on J/psi production in Pb—Pb collisions

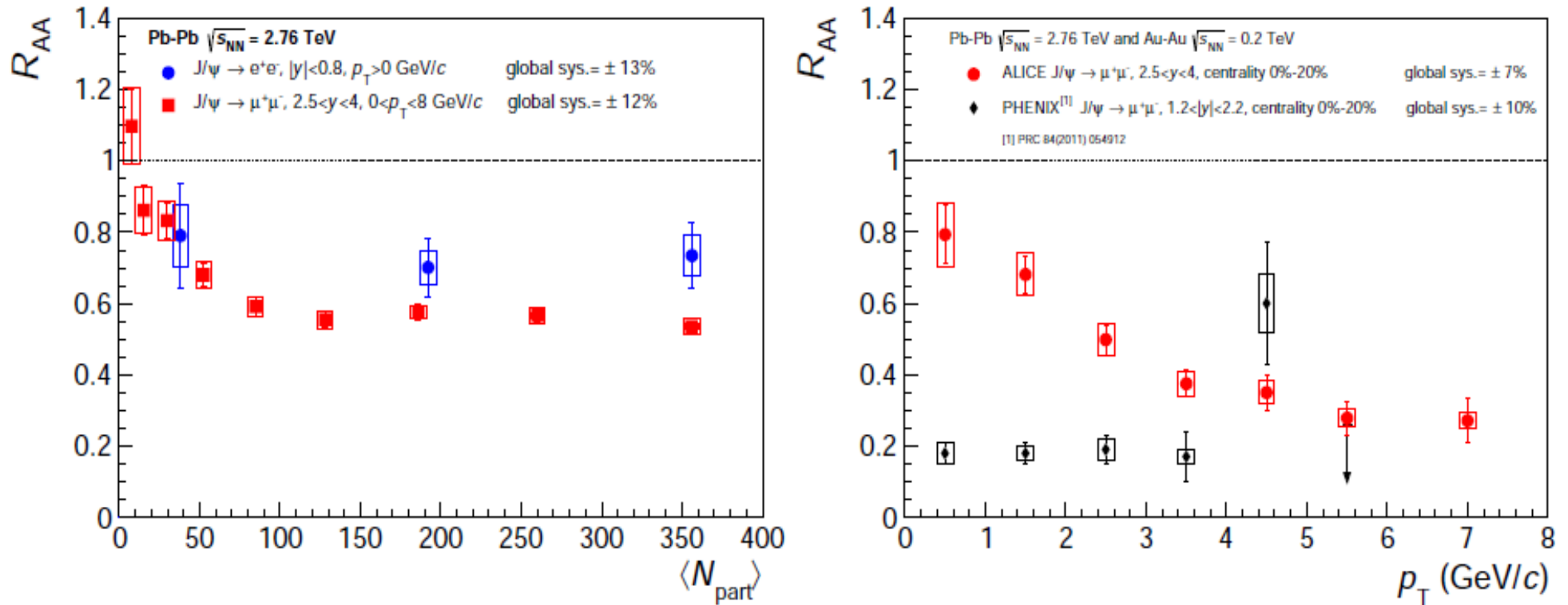

Despite increased energy density at LHC energy, R_{AA} increases at low transverse momenta when going from RHIC to LHC energy \rightarrow

complete color screening and deconfinement for charm quarks

Sequential Upsilon suppression

2010 data

PRL 107 (2011) 052302

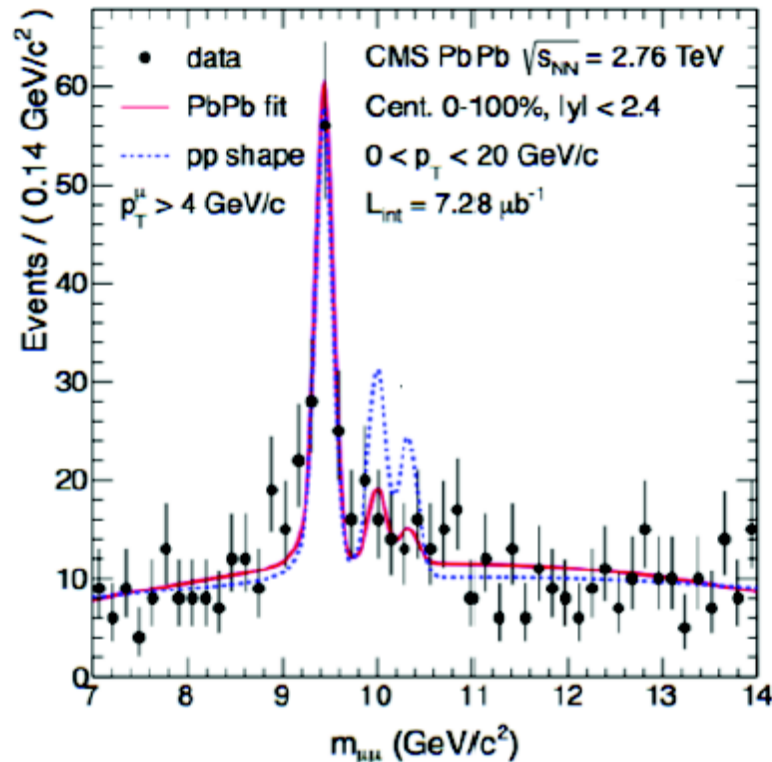

Indication of suppression of
(Y(2S)+Y(3S)) relative to Y(1S)
→ 2.4 σ significance

2011 data

PRL 109 (2012) 222301

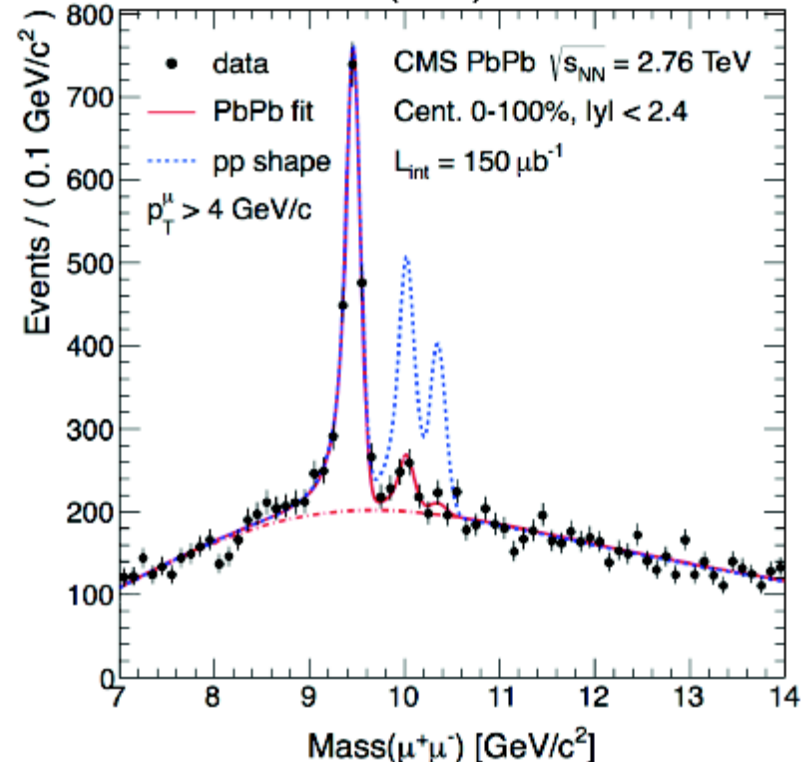

Observation of sequential
suppression of Y family
→ Detailed studies

summary – quarkonium production

- spectacular difference between results from RHIC and LHC
- J/ψ production is consistent with complete Debye screening and (re-)generation at the QCD phase boundary
- charm quarks are thermalized and deconfined
- Y production: also suppressed but unclear relation to color screening are b quarks and/or Y thermalized?

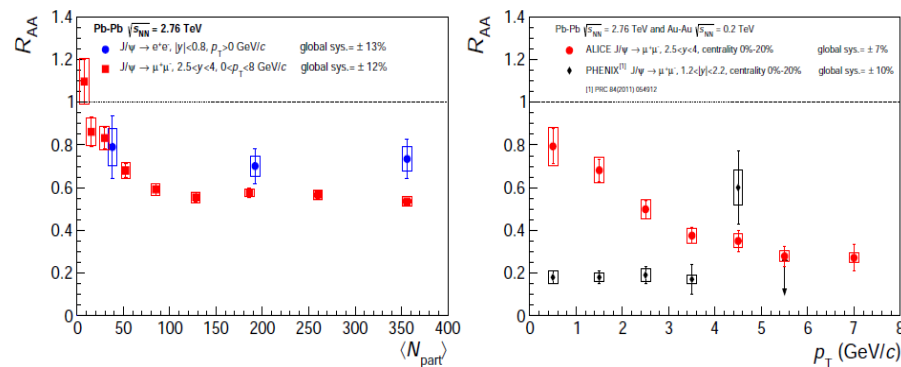

The future

PHENIX in next 5 years

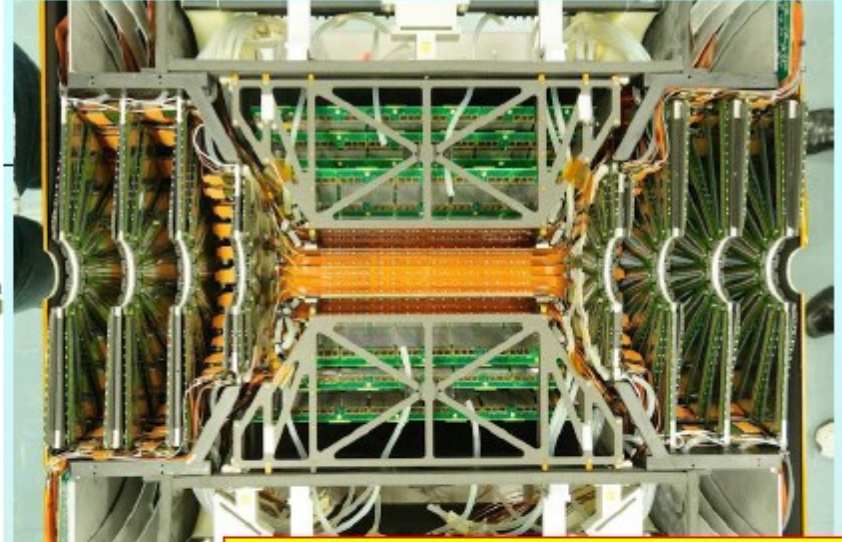
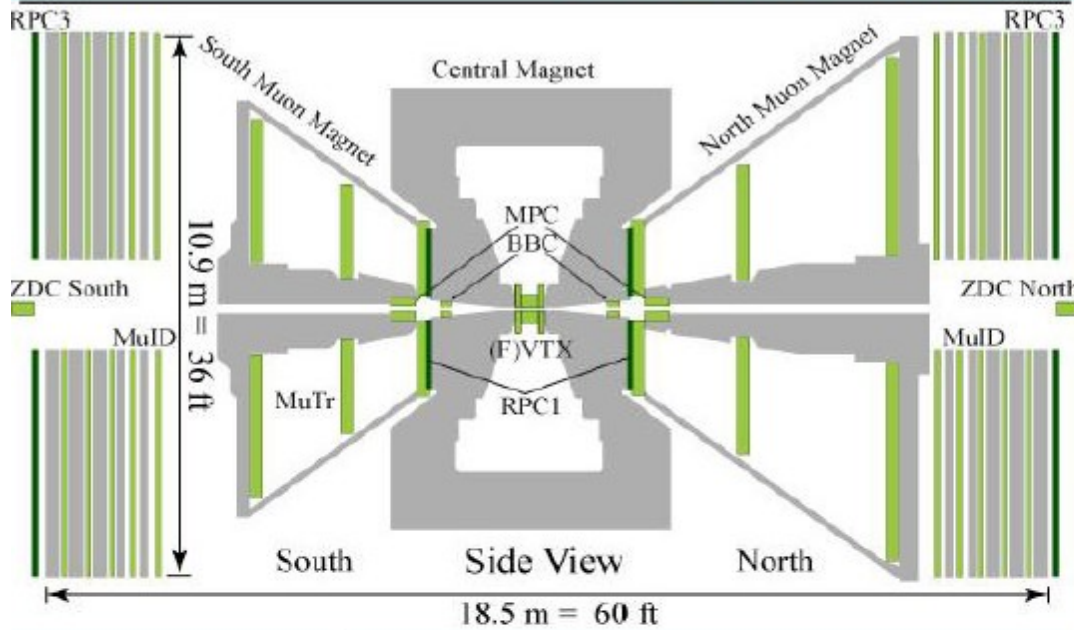

VTX & FVTX in place

MPC-EX in 2014
**Si/W preshower/
 tracker before MPC**

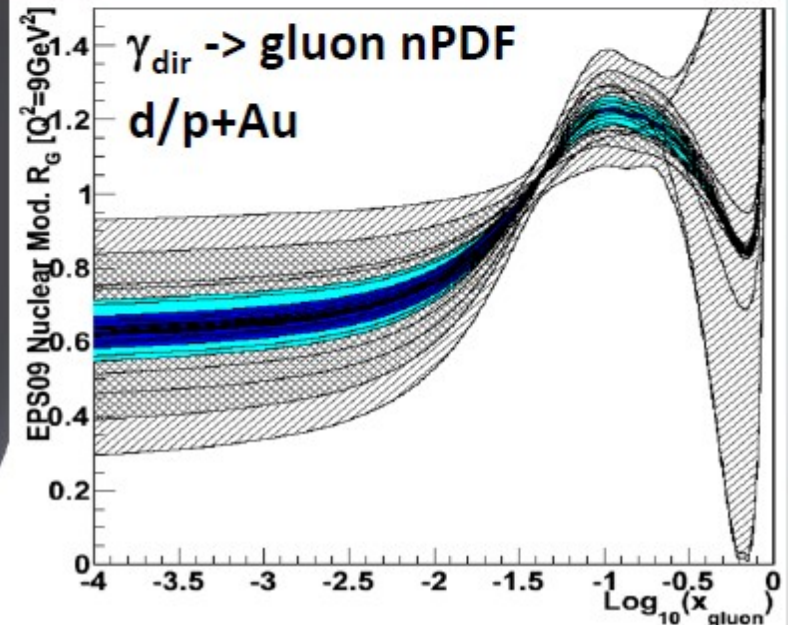
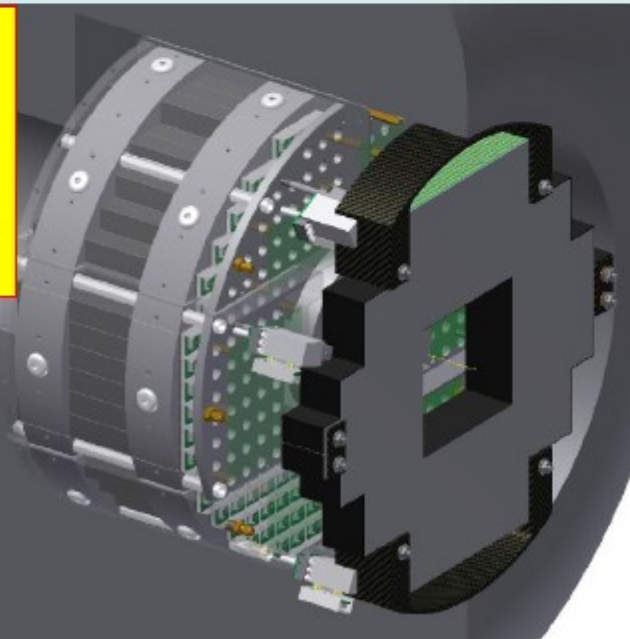

STAR in the next 5 years

Mid-rapidity *STAR*

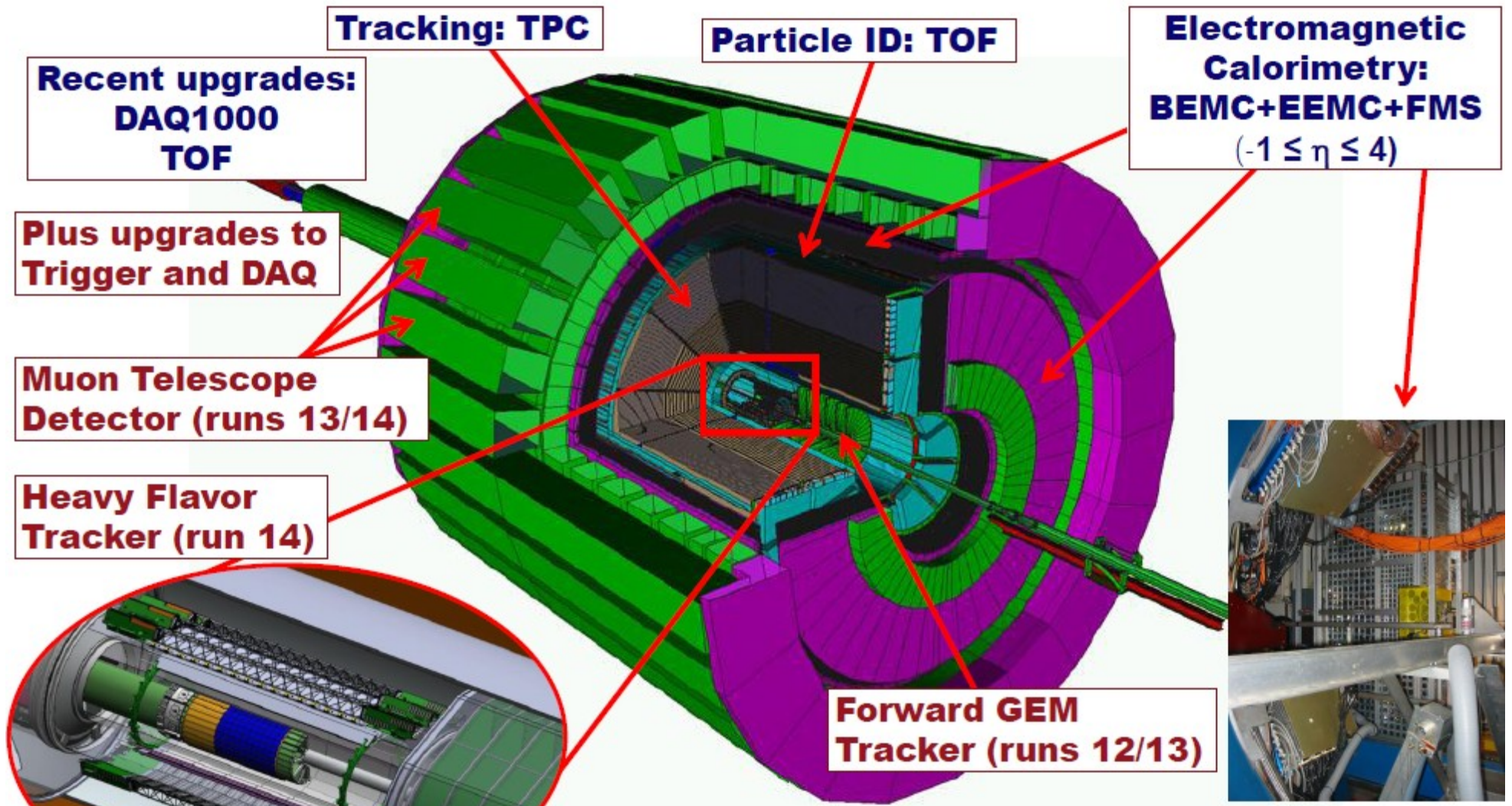

Full azimuthal particle identification over a broad range in pseudorapidity

ALICE future

2 letters of intent
endorsed by LHCC and approved by research board

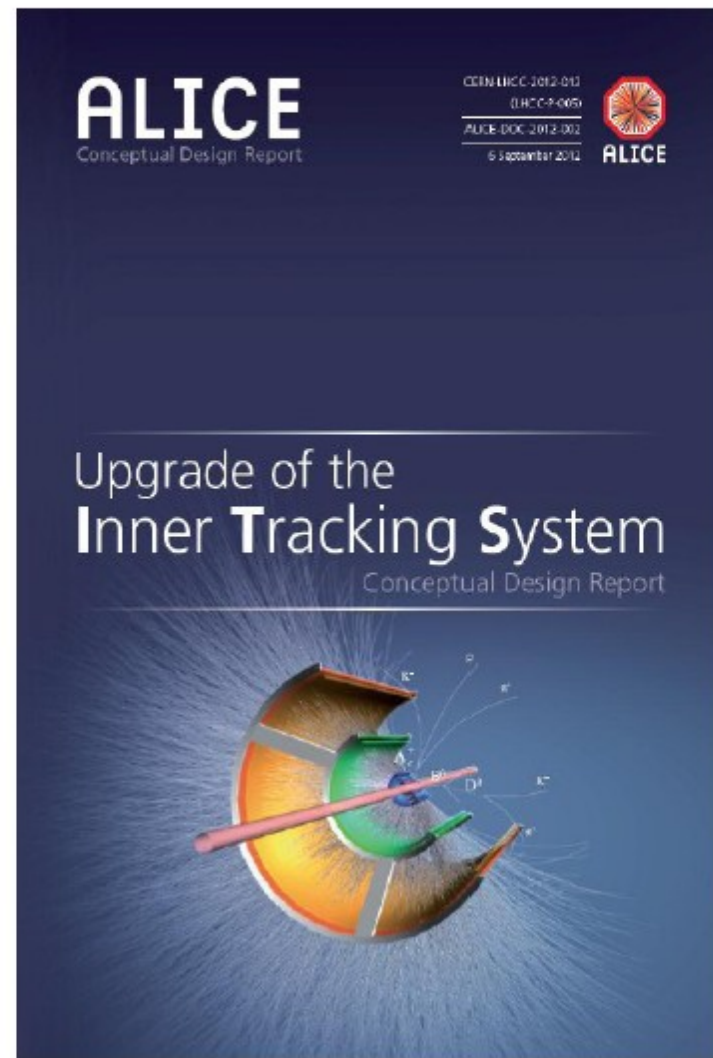
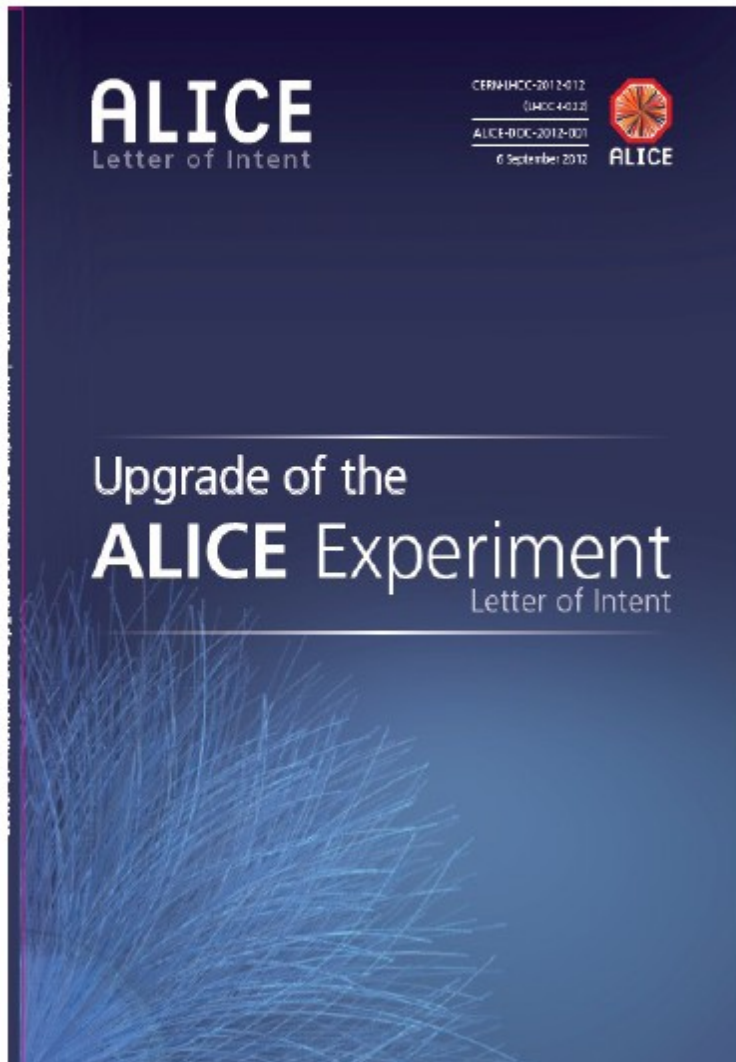

main physics motivation for ALICE upgrade

measure Pb—Pb collisions at high rate (50 kHz) to investigate:

- heavy flavor production and transport parameters
- quarkonium production, deconfinement and Debye screening
- low mass lepton pairs and chiral symmetry restoration

this needs approximately 10/nb integrated Pb—Pb lumi

factor of 100 increase in statistical reach

Lol recently endorsed by LHCC and CERN Research Board

ALICE looks forward to continued (until about 2025)

exciting and fundamental experiments with ions in the LHC

2nd generation HI experiments

BES STAR/PHENIX@BNL/RHIC

NA61@CERN/SPS

3rd generation HI experiments

CBM@FAIR/SIS-100/300

Fixed target, $E/A=10-40$ GeV, highest intensity

MPD@JINR/NICA

Collider, $\sqrt{s_{NN}} = 4-11$ GeV, $L \sim 10^{27} \text{ cm}^{-2}\text{s}^{-1}$ for Au79+

+ possible experiments at JPARC, currently under consideration, $E/A < 15$ GeV

+ design studies for CERN/SPS, $10 < E/A < 160$ GeV

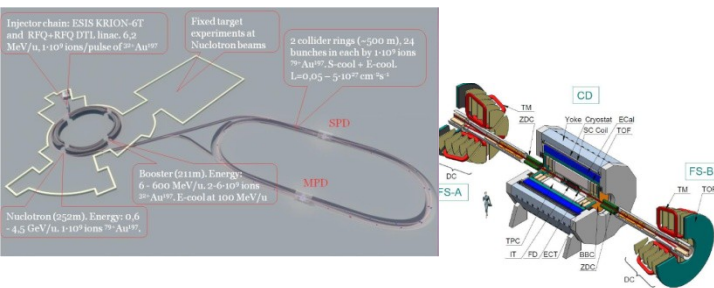
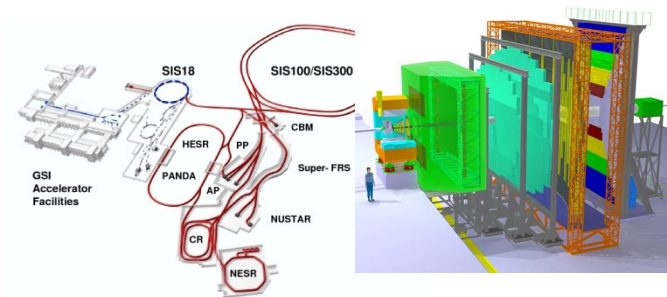
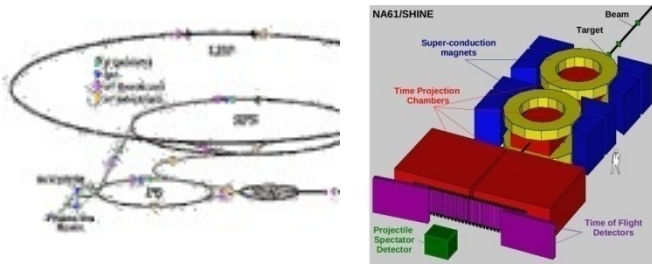
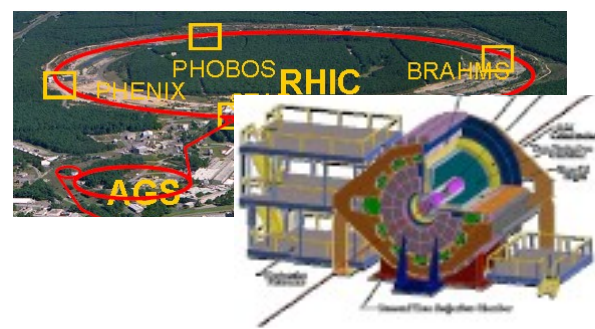

Nuclear matter physics at SIS100

- Nuclear equation-of-state, new forms of matter at high densities?

What are the properties and the degrees-of-freedom of nuclear matter at neutron star core densities?

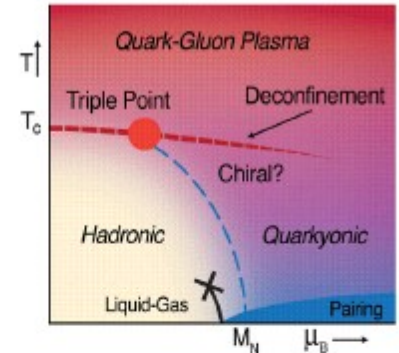
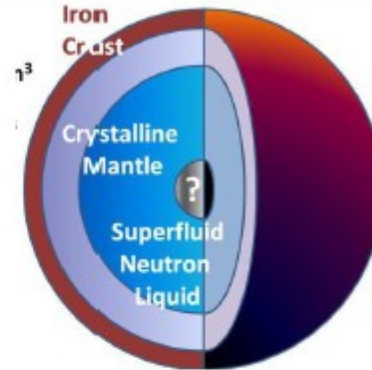

- Hadrons in dense matter:

What are the in-medium properties of hadrons?
Is chiral symmetry restored at very high baryon densities?

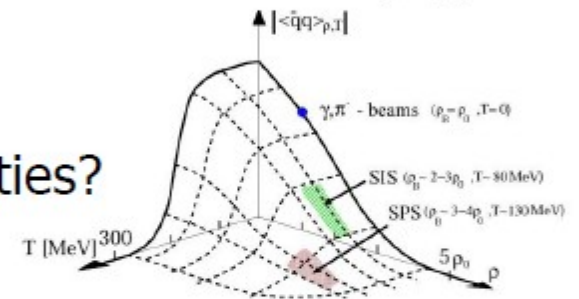

- Production of single and double hypernuclei

How far can we extend the third (strange) dimension of the nuclear chart?

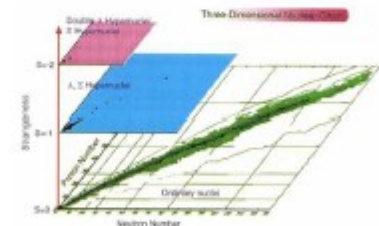

- Strange matter:

Does strange matter exist in the form of heavy multi-strange objects?

?

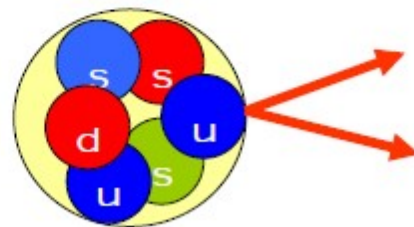

- Heavy flavor physics:

How is charm produced at low beam energies, and how does it propagate in cold nuclear matter?

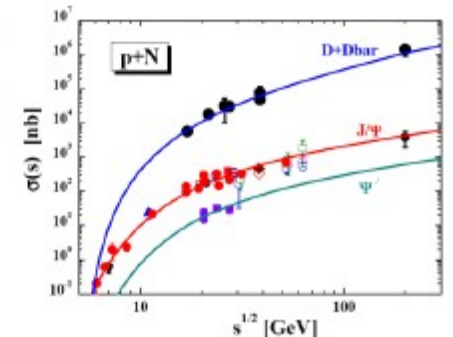

QCD phase diagram: prospects for NICA

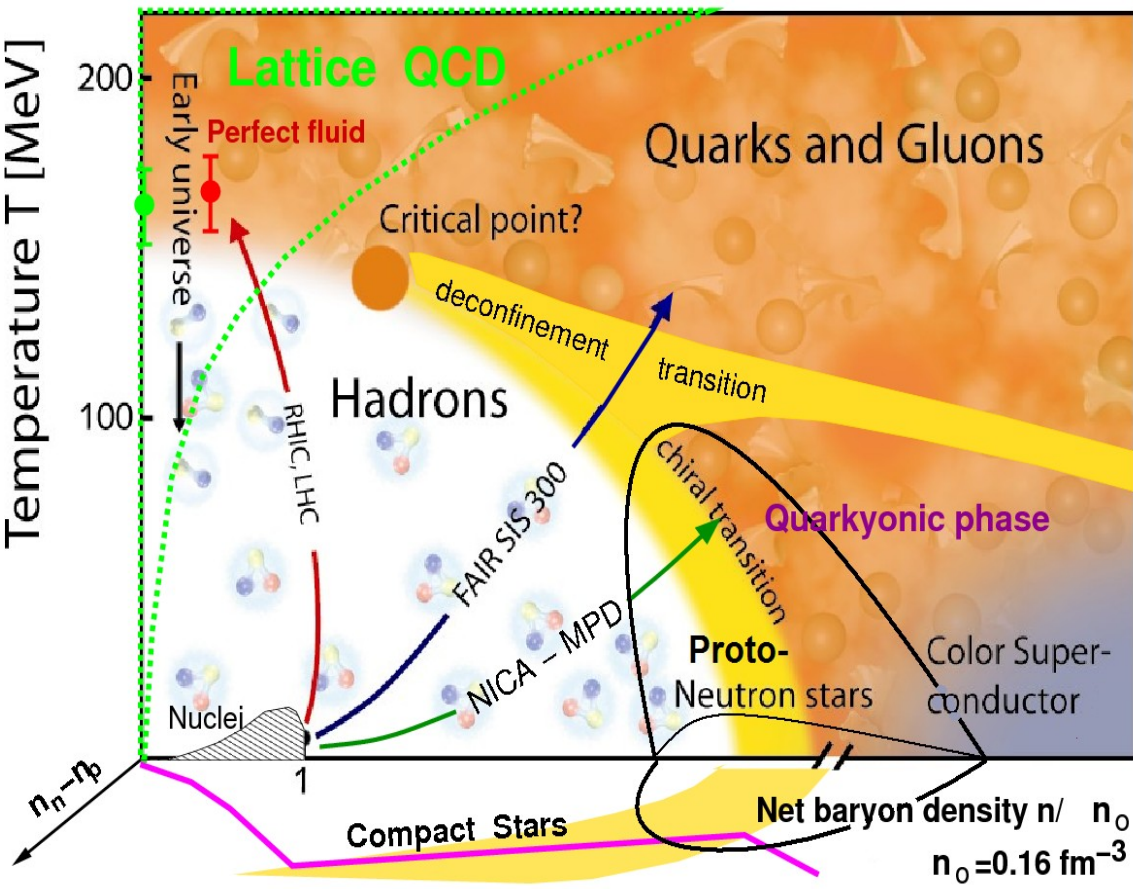

- Energy Range of NICA**
unexplored region of the QCD phase diagram:
- Highest net baryon density
 - Onset of deconfinement phase transition
 - Discovery potential:
 - a) Critical End Point (CEP)
 - b) Chiral Symmetry Restoration
 - c) Hypothetic Quarkyonic phase
 - Complementary to the RHIC/BES, NA61/CERN, CBM/FAIR and Nuclotron-M experimental programs

Comprehensive experimental program requires scan over the QCD phase diagram by varying collision parameters: system size, beam energy and collision centrality. NICA provides capabilities for studying a variety of phenomena in a large region of the phase diagram.

Strategy issues

Heavy ion running at LHC and near future

2 PbPb runs

- 2010 $O(10 \mu\text{b}^{-1})$

- 2011 $O(150 \mu\text{b}^{-1})$

luminosity reached $\mathcal{L}=2 \cdot 10^{26} \text{ cm}^{-2} \text{ s}^{-1}$ twice design lumi at this energy

1 pPb run

- 2012/2013 $O(30 \text{ nb}^{-1})$

from 2/2013 until end of 2014 LS1: consolidation of LHC to allow full energy

2015-2017 PbPb running at $\sqrt{s_{\text{NN}}} = 5.5 \text{ TeV}$ at up to 4 x design lumi to achieve approved initial goal of 1 nb⁻¹

2018 start LS2 – increase of LHC luminosity (timing to be optimized in 9/13)

ALICE Physics goals for future heavy ion running

precision measurements in

- charm sector – charmonia, open charm, thermal charm, flow and equilibration, fundamental issues with bound quarks in QGP
- beauty sector – question of thermalization/equilibration
- low mass lepton pairs – chiral restoration and thermal radiation
- real (and virtual) photons – evolution of temperature and quark fugacities, role of hadronic phase
- jets
- search for exotica

- aim to reach text book level results

Fundamental questions such as:

Is there a common phase boundary for all quark flavors?

Are there hadronic bound states at $T > T_c$?

Can critical behavior near T_c be detected?

Main conclusions, Heavy Ion Town Meeting, June 30, 2012, CERN

> 160 participants, all major labs world-wide represented

1. The top priority for future quark matter research in Europe is the full exploitation of the physics potential of colliding heavy ions in the LHC.
2. At lower centre-of-mass energies where the highest baryon densities are reached, advances in accelerator and detector technologies provide opportunities for a new generation of precision measurements that address central questions about the QCD phase diagramme.
3. The complementarity of LHC and RHIC is an essential resource in efforts to quantify properties of the Quark-Gluon Plasma.
4. Dedicated investments in theoretical research are needed to fully exploit the opportunities arising from the upcoming precision era of nuclear research at collider and fixed target energies.

Discussion at the Cracow open symposium: Heavy Ions

- general agreement on LHC experiments as major priority
- support for high lumi upgrade of ALICE
- need for coordination among experiments at lower energy:
FAIR/CBM, NICA, RHIC/BES
- special role of CERN/SPS

Update of the European Strategy for Particle Physics by the European Strategy Group for Particle Physics

unanimously approved by CERN Council on
May 30, 2013

High-priority large-scale scientific activities

After careful analysis of many possible large-scale scientific activities requiring significant resources, sizeable collaborations and sustained commitment, the following four activities have been identified as carrying the highest priority.

c) The discovery of the Higgs boson is the start of a major programme of work to measure this particle's properties with the highest possible precision for testing the validity of the Standard Model and to search for further new physics at the energy frontier. The LHC is in a unique position to pursue this programme. *Europe's top priority should be the exploitation of the full potential of the LHC, including the high-luminosity upgrade of the machine and detectors with a view to collecting ten times more data than in the initial design, by around 2030. This upgrade programme will also provide further exciting opportunities for the study of flavour physics and the quark-gluon plasma.*

Heavy Ion Physics with ALICE, ATLAS, and CMS will be part of the LHC menu for the coming decade with an interesting menu of fundamental measurements to look forward to.

Additional slides

Achievement with 1nb^{-1}

from data analyzed up to now we can extrapolate:

physics goals with hadrons in the uds sector and for $p_t < 10$ GeV achieved

- abundances, spectra, R_{AA} , flow, correlations

large cross section issues in heavy quark sector solved as well

Future after LS2

achieve for PbPb 10 nb⁻¹ corresponding to 8 10¹⁰ collisions sampled
plus a low field run of 3 nb⁻¹
pp reference running 6 pb⁻¹ or 1.4 10¹¹ collisions
pPb sample 50 nb⁻¹

this is a program of about 6 years probably interrupted by another 2
year long shutdown around 2022/23 leading us to 2026 or so

envisage PbPb peak luminosities of $\mathcal{L} = 6 \cdot 10^{27} \text{ cm}^{-2} \text{ s}^{-1}$
corresponding to interaction rates of 50 kHz – **more than 6 x design
lumi**

detector upgrades with **continuous read-out**
to cope with this luminosity and
to achieve physics goals aimed for with this integrated luminosity
improved tracking and vertexing and excellent PID