

Atoms as electron accelerators

Leveraging atomic electron momentum distribution in fixed target experiments



Istituto Nazionale di Fisica Nucleare
Laboratori Nazionali del Gran Sasso

Giovanni Grilli di Cortona

giovanni.grilli@lngs.infn.it

based on

F. Arias Aragon, L. Darmé, G^2dC and E. Nardi, 2403.15387, PRL132(2024)261801

F. Arias Aragon, L. Darmé, G^2dC and E. Nardi, 2407.15941, accepted by PRL

F. Arias Aragon, L. Darmé, G^2dC , E. Nardi and L. Veissière, in preparation

The Low-Energy Frontier of Particle Physics - 11/02/2025

Outline

1. Motivation
2. Dark sector resonant production
 - Thick target
 - Thin target
3. Free electrons at rest
4. Atomic electron motion
5. Atoms as electron accelerators
 - Search for the X_{17} at PADME
 - New physics searches
 - A proposal to measure the hadronic cross section

Motivation

The X_{17} saga

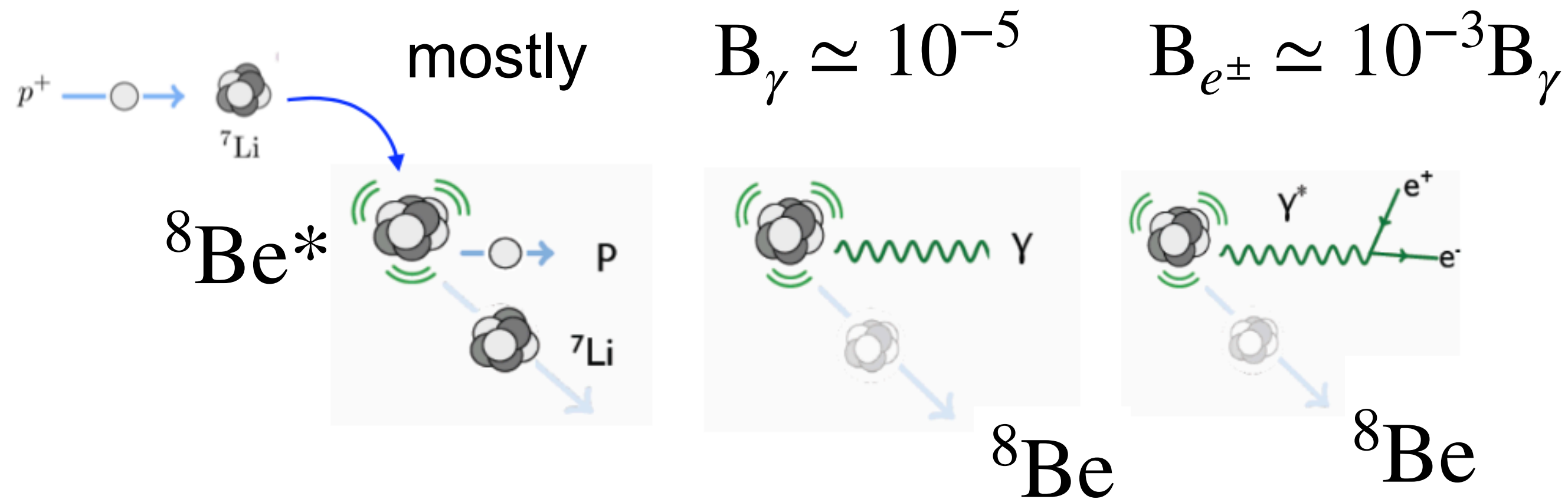

The X_{17} saga

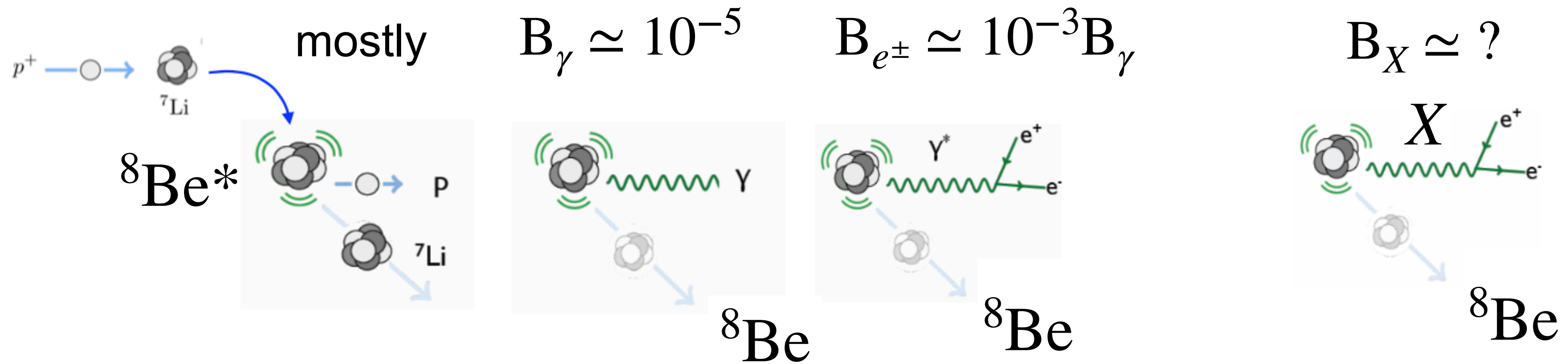

The X_{17} saga

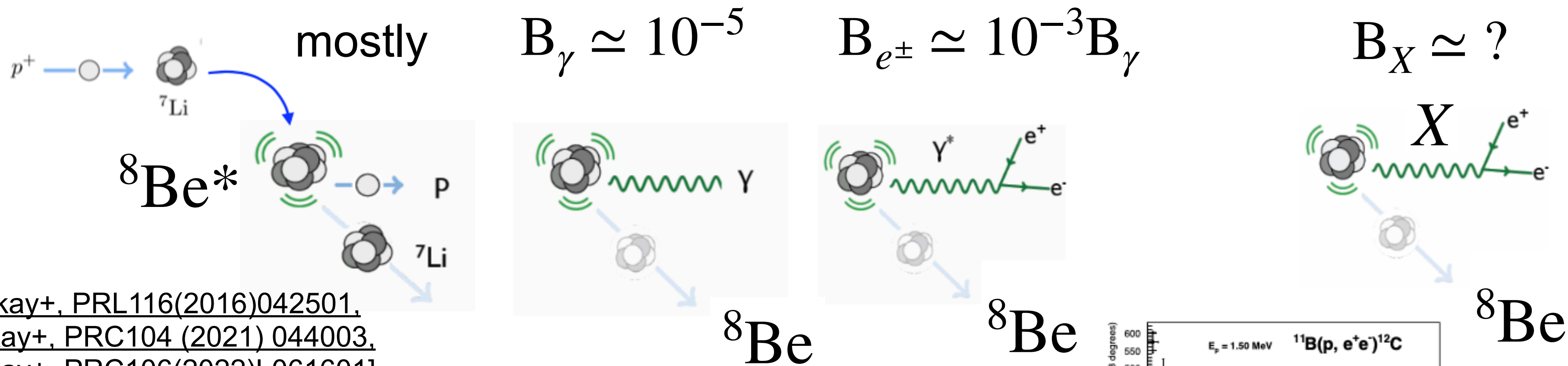

[\[Krasznahorkay+, PRL116\(2016\)042501,](#)
[Krasznahorkay+, PRC104 \(2021\) 044003,](#)
[Krasznahorkay+, PRC106\(2022\)L061601\]](#)

Anomaly observation in ${}^8\text{Be}$, ${}^4\text{He}$ and ${}^{12}\text{C}$ transitions

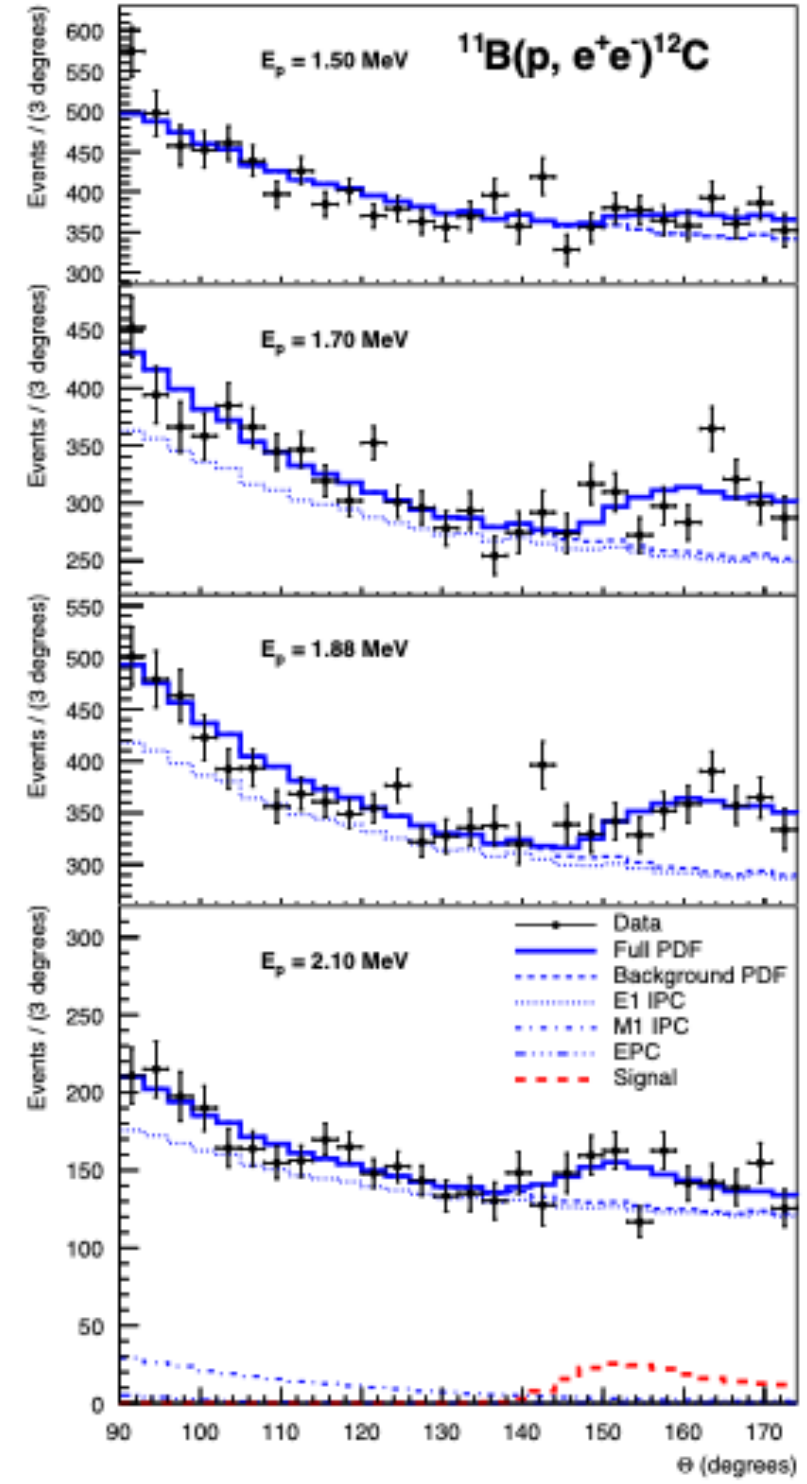
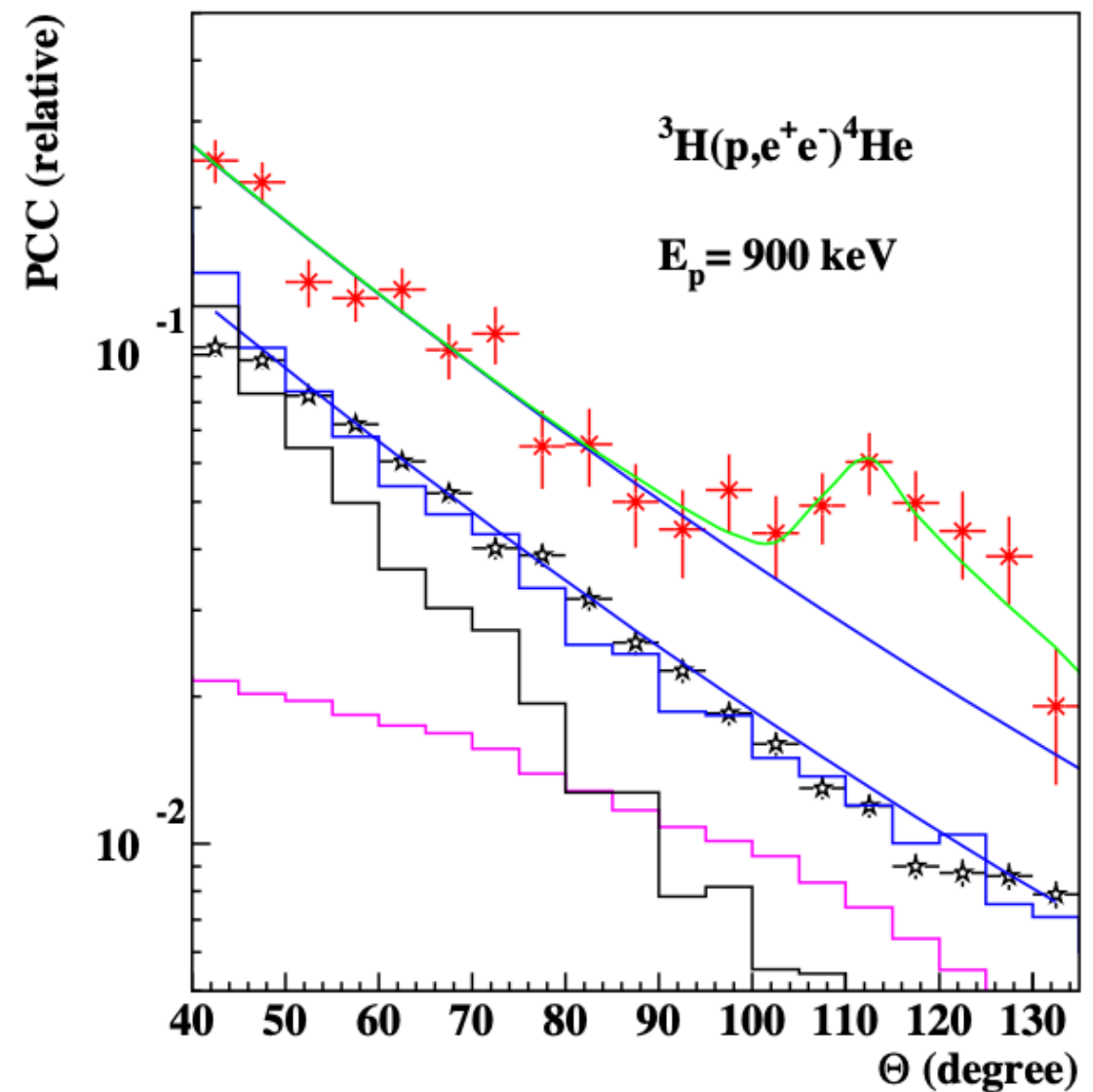
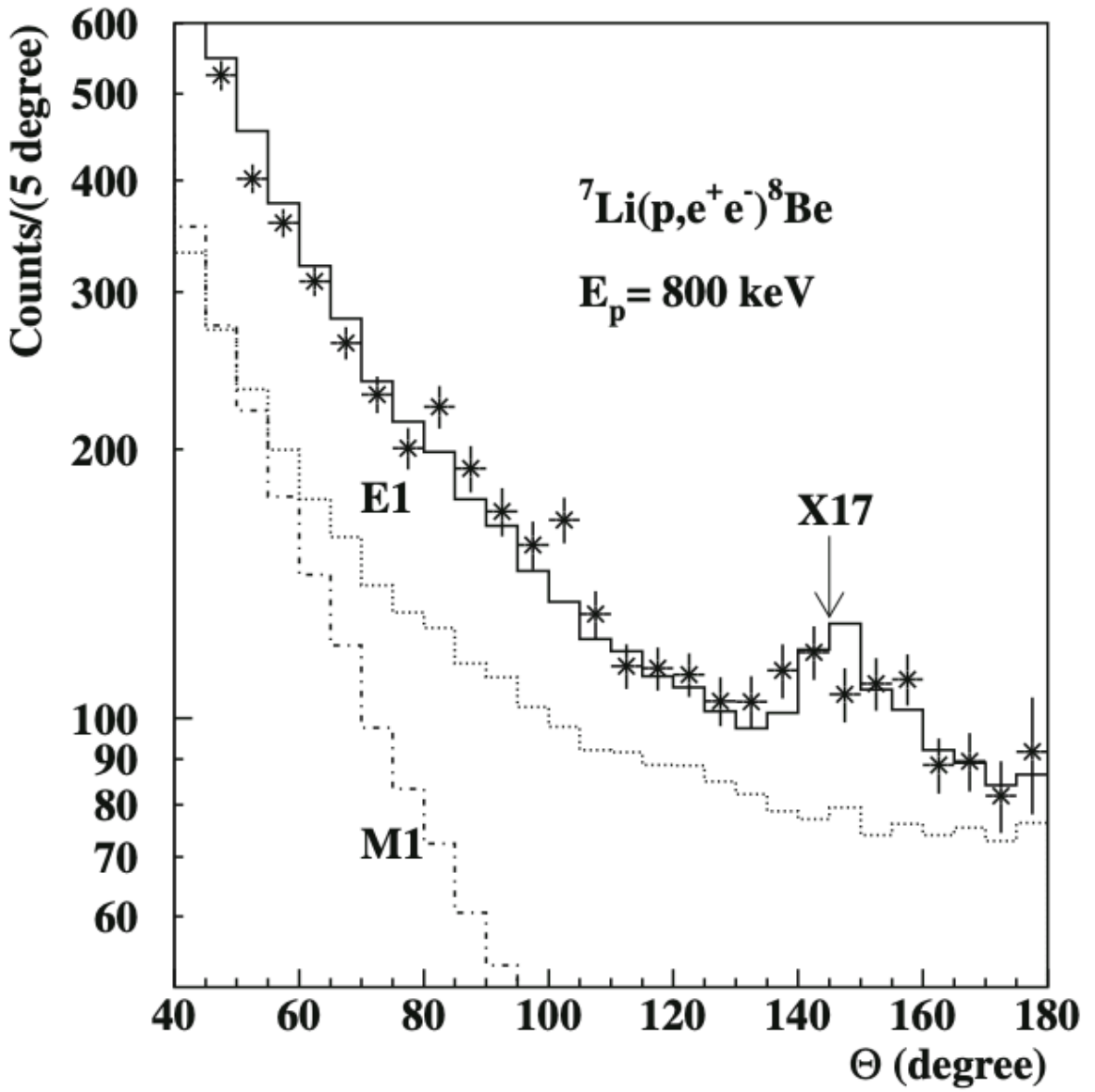

Searches at fixed target exp.

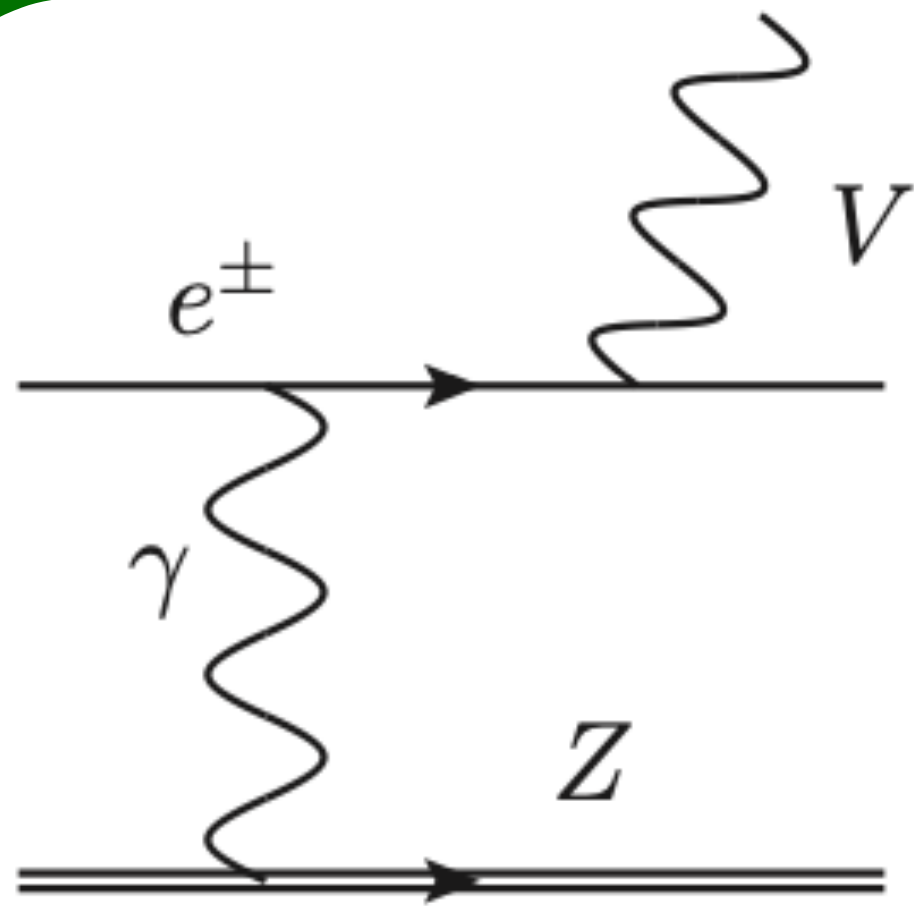

Electron/positron beam
fixed target experiments

Dark photon production
via Bremsstrahlung:
APEX, NA64, ...

Searches at fixed target exp.

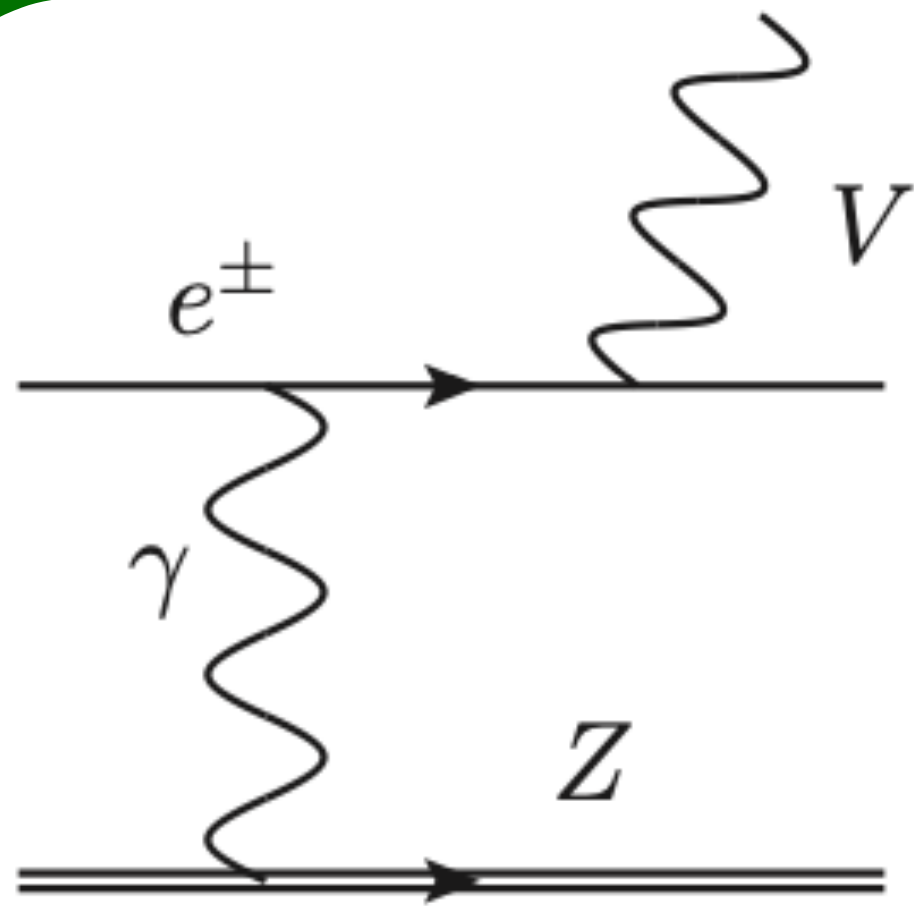

Electron/positron beam fixed target experiments

Dark photon production via Bremsstrahlung: APEX, NA64, ...

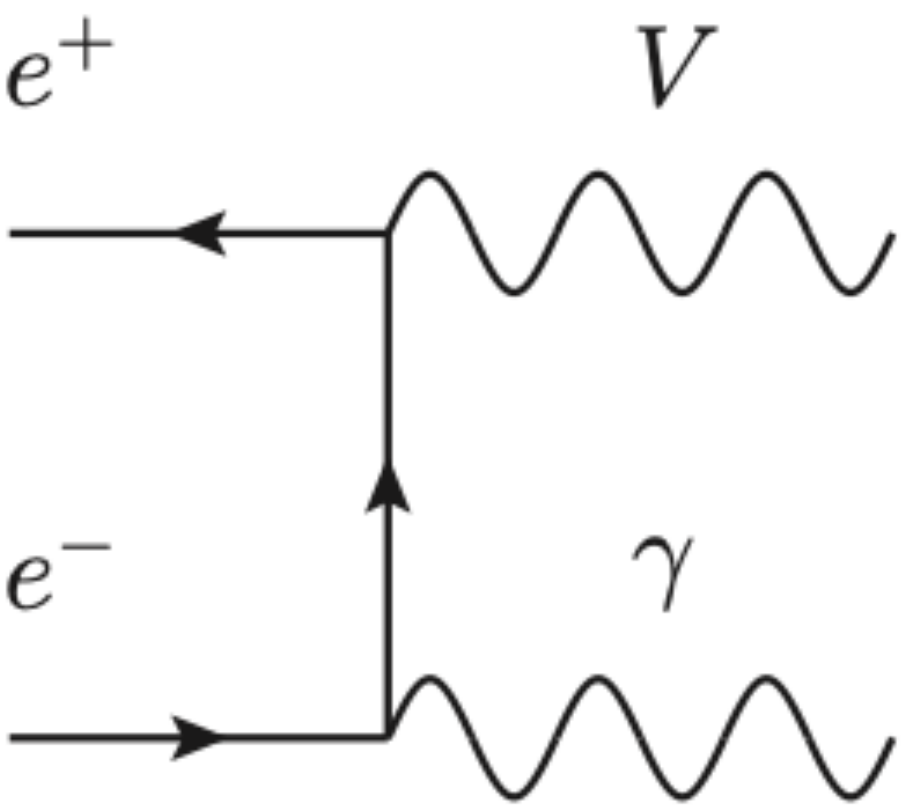

Positron beams fixed target experiments

Dark photon associate production: PADME (Frascati National Lab.), VEPP3, CERN, JLab, ...

Searches at fixed target exp.

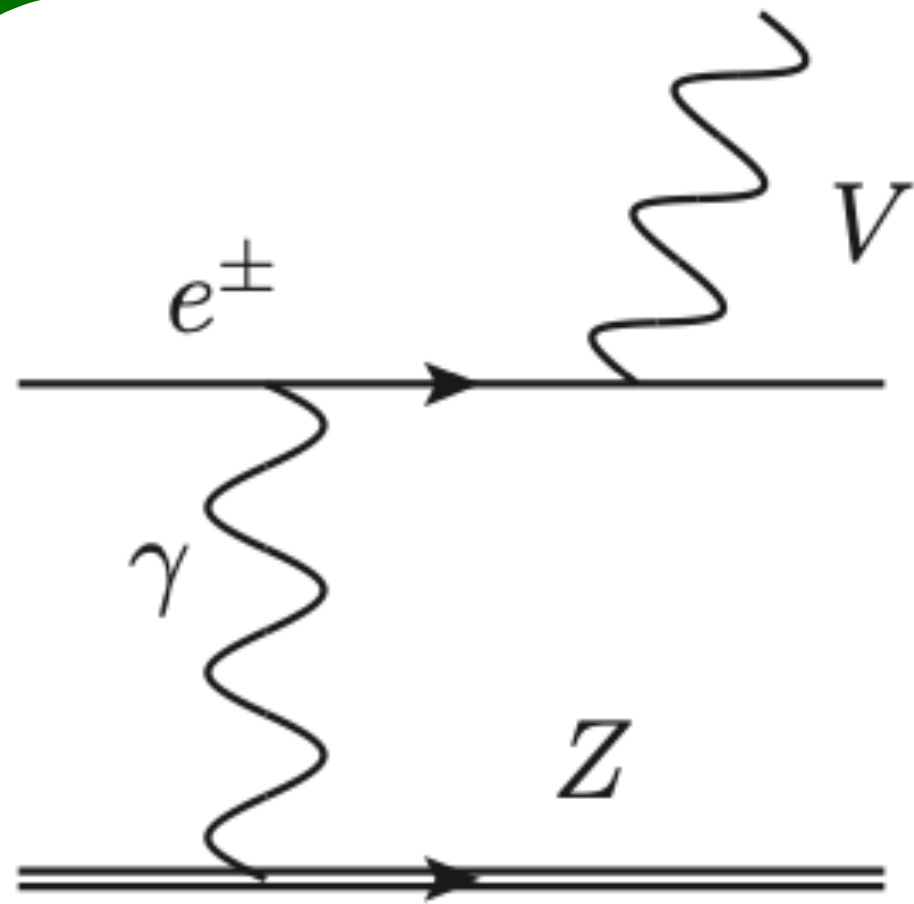

Electron/positron beam fixed target experiments

Dark photon production via Bremsstrahlung:
APEX, NA64, ...

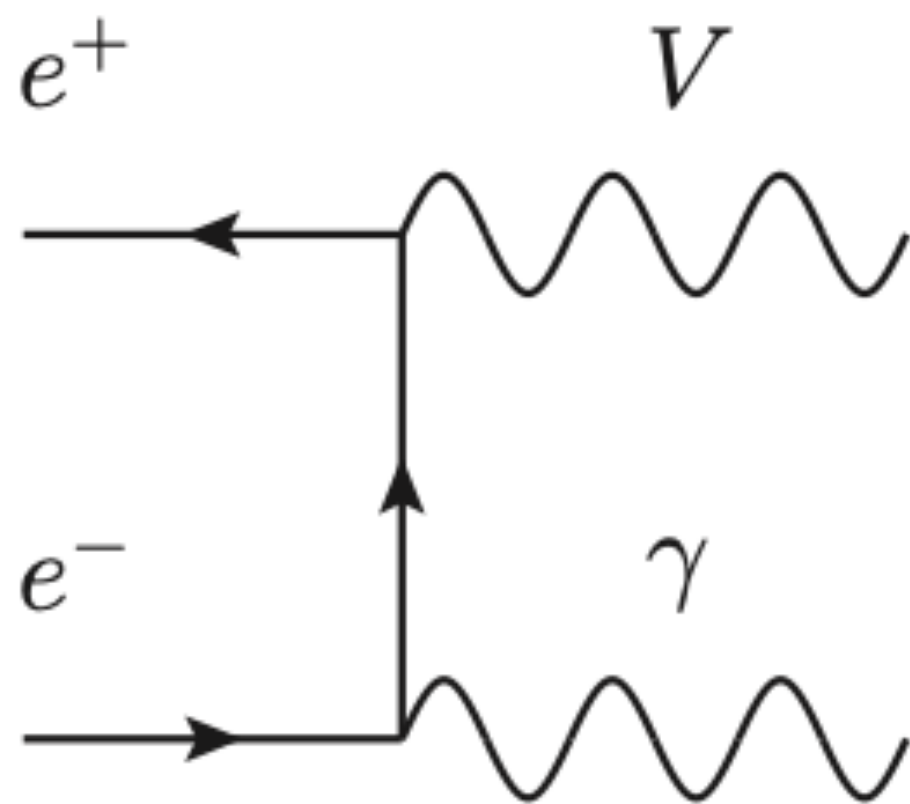

Positron beams fixed target experiments

Dark photon associate production: PADME (Frascati National Lab.), VEPP3, CERN, JLab, ...

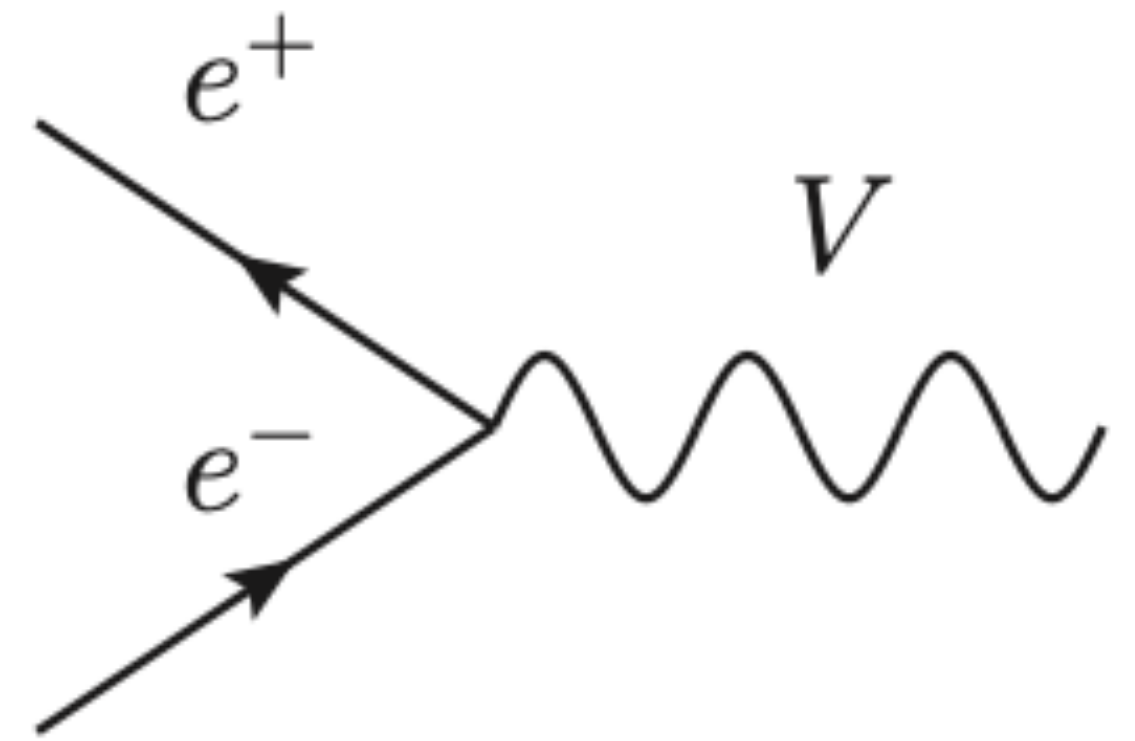

Positron beam fixed target experiments

Positron - electron resonant annihilation $e^+e^- \rightarrow A'$:

[Nardi et al., Phys. Rev. D (2018) 9, 095004]

Dark Sector resonant
production

Resonant production

[Nardi et al., Phys. Rev. D (2018) 9, 095004]

Thick fixed target

$$\ell_{\text{target}} \gtrsim X_0$$

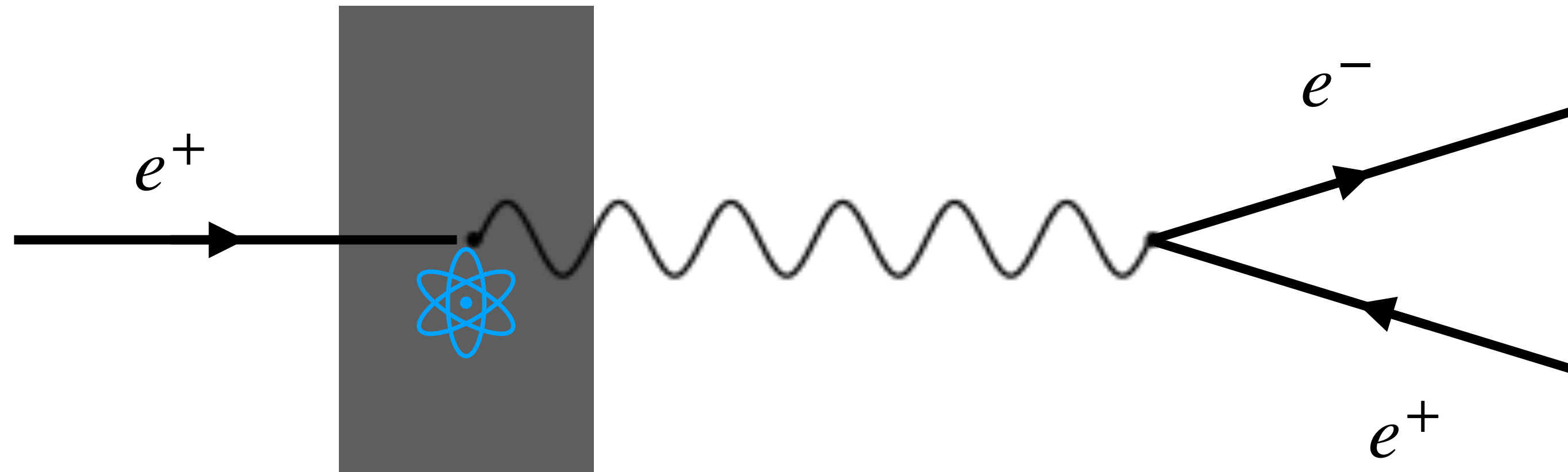

Take advantage of energy loss of the positrons propagating through matter, effectively scanning in energy until hitting the resonance.

Resonant production

[Nardi et al., Phys. Rev. D (2018) 9, 095004]

Thick fixed target

$$\ell_{\text{target}} \gtrsim X_0$$

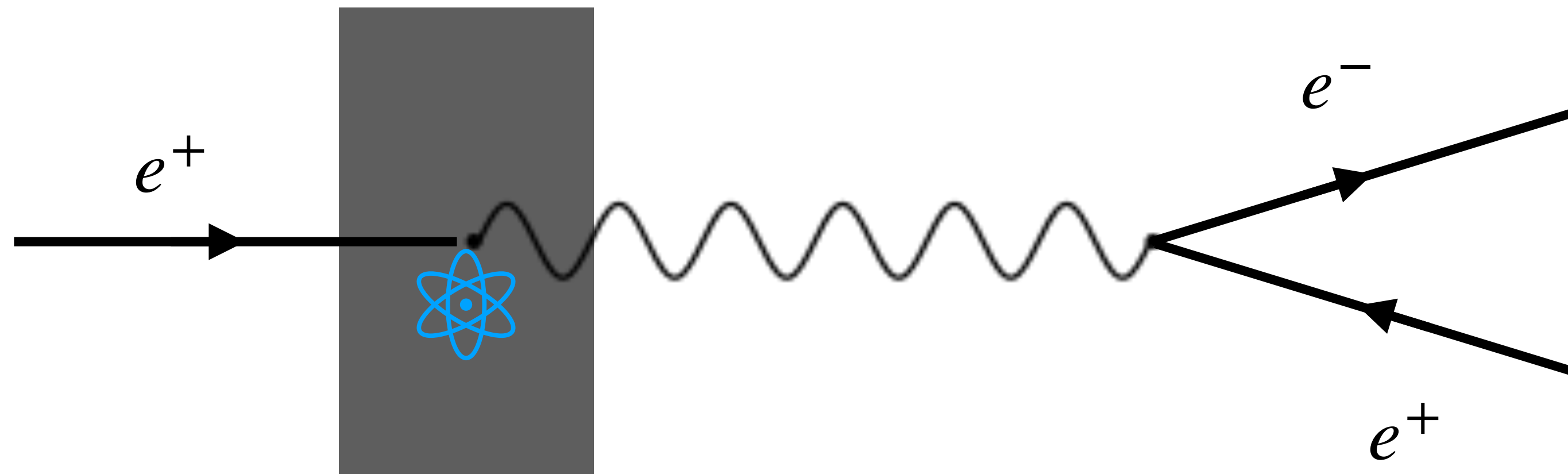

Take advantage of energy loss of the positrons propagating through matter, effectively scanning in energy until hitting the resonance.

number of target electrons

Gaussian beam energy spread

$$N_{A'} = \left(1 - e^{-\frac{z_D - z_{\text{det}}}{\ell_e}}\right) \frac{N_{\text{pot}} N_{\text{Av}} Z \rho X_0}{A} \int_0^T dt \frac{d\mathcal{P}(t, z_D, \ell_e)}{dt} \int dE_e \int dE \mathcal{G}(E, E_B, \sigma_B) I(E, E_e, t) \sigma(E_e)$$

probability that the dark photon decays before the detector but outside the target

probability of finding a positron with energy E_e after passing through t radiation lengths

Resonant production

Thick fixed target

[Nardi et al., Phys. Rev. D (2018) 9, 095004]

$$\mathcal{L} \supset -i\epsilon e \bar{\psi}_e \gamma^\mu \psi_e A'_\mu$$

$$E_B \simeq 282 \text{ MeV}$$

$$N_{\text{pot}} = 10^{18}$$

2-10 cm of tungsten

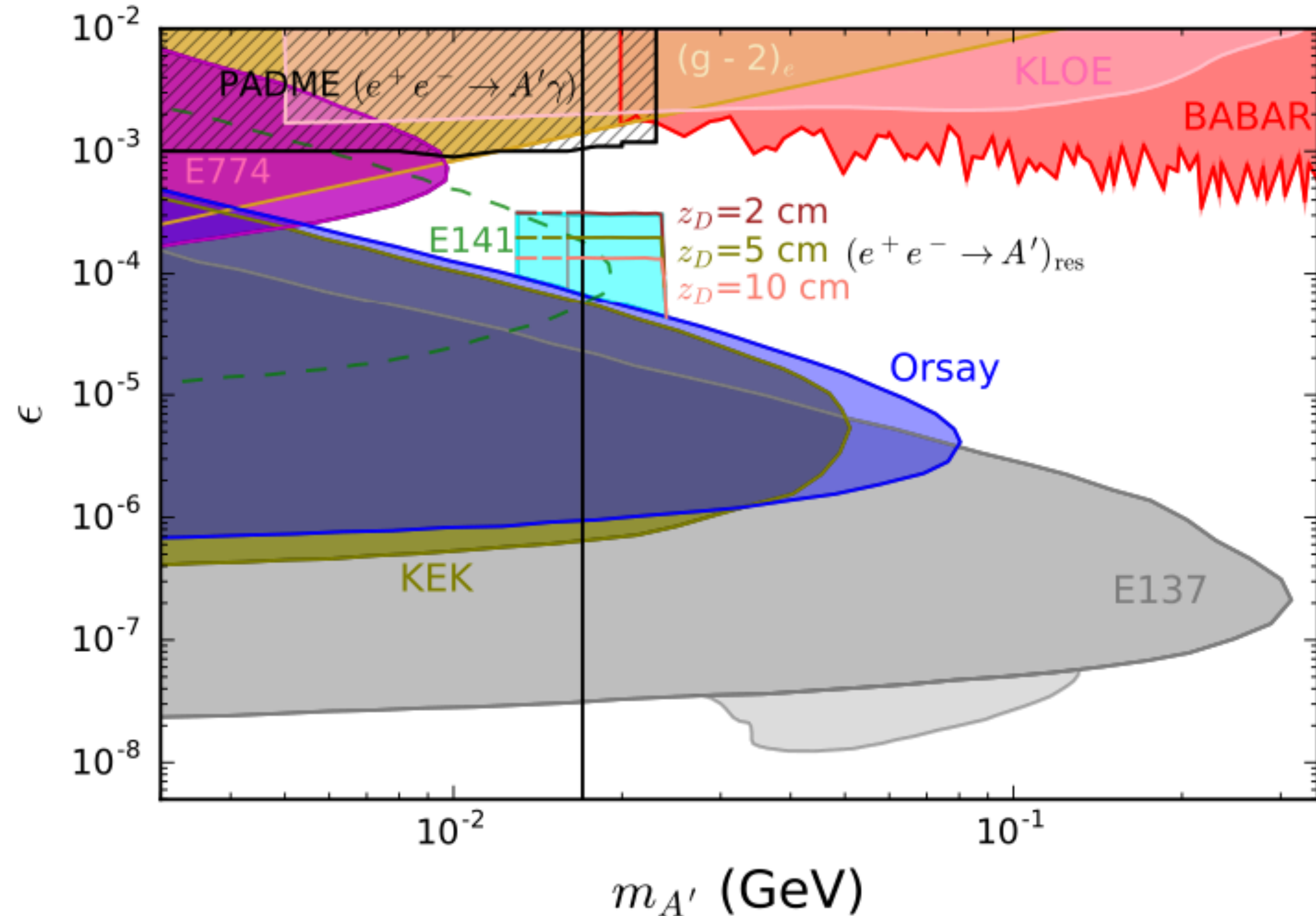

Resonant production

Thin fixed target

$$\ell_{\text{target}} \ll X_0$$

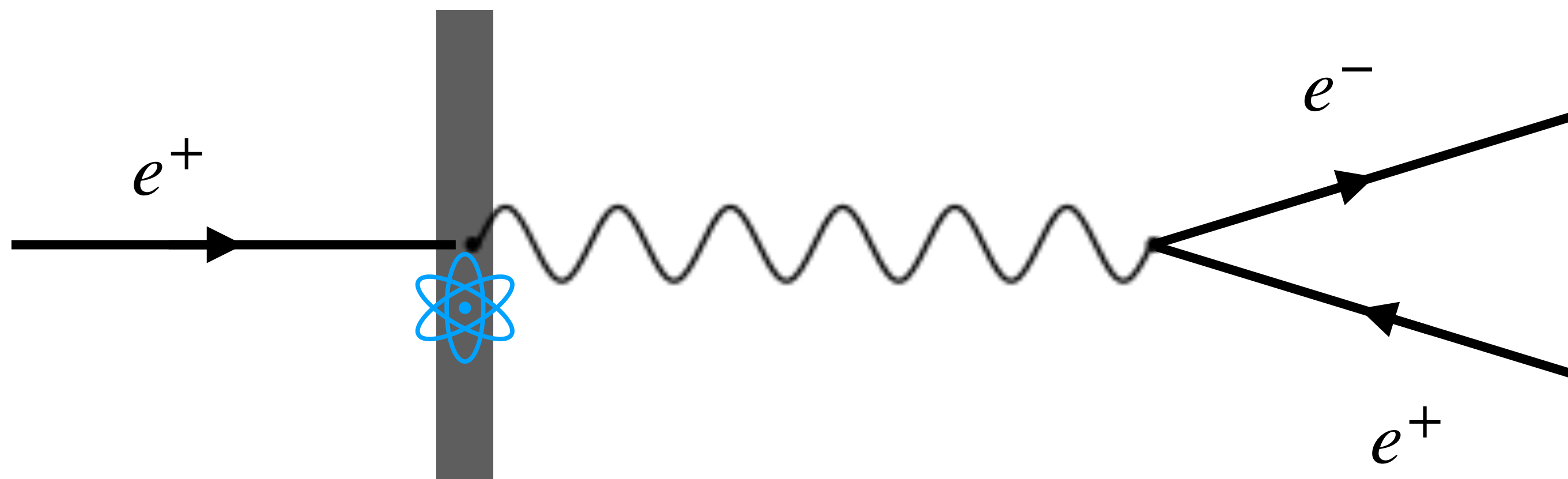

Negligible energy loss, need to physically vary the beam energy

Resonant production

Thin fixed target

$$\ell_{\text{target}} \ll X_0$$

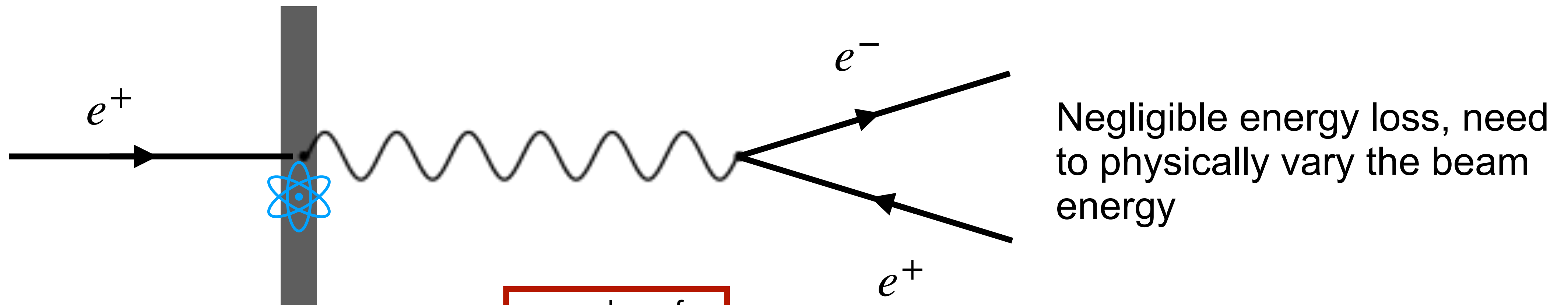

number of target electrons

$$N_{A'} = N_{\text{pot}} \frac{N_{\text{Av}} Z \rho}{A} \ell_{\text{target}} \int dE \mathcal{G}(E, E_B, \sigma_B) \sigma(E)$$

Gaussian beam energy spread

Resonant production

PADME strategy for the X_{17} search

[Darmé, Mancini, Nardi, Raggi, Phys. Rev. D 106 (2022) 11, 115036]

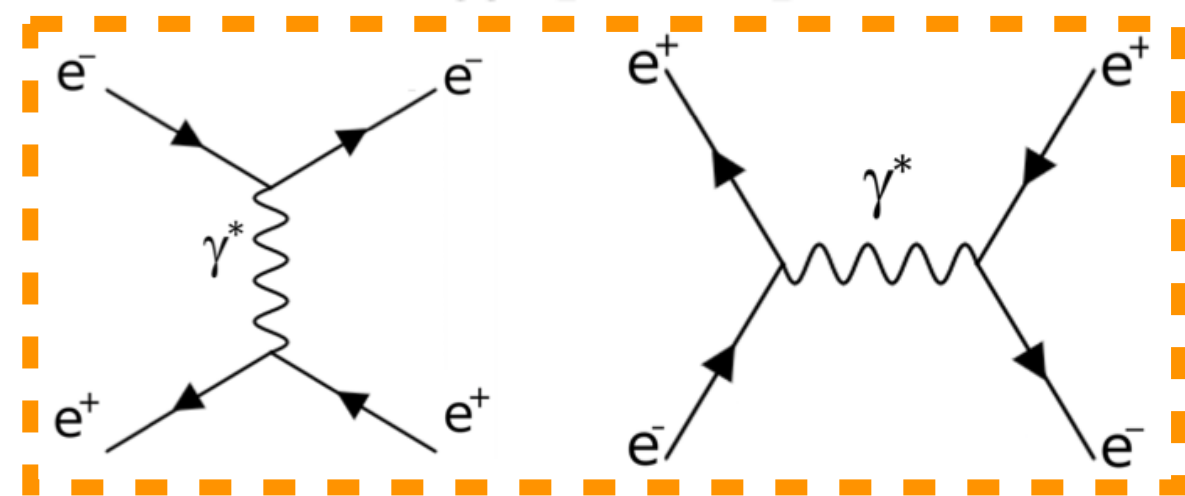
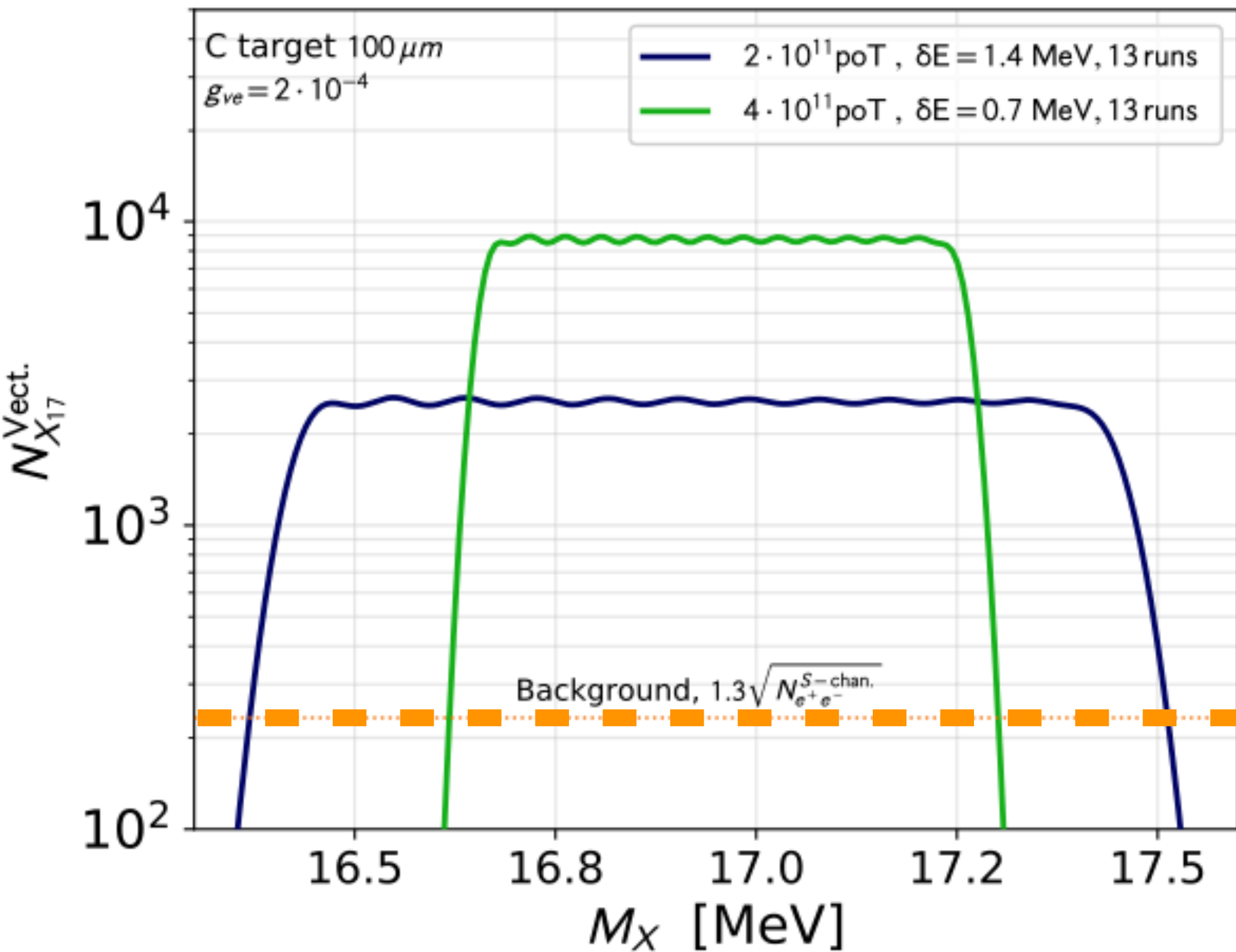

Resonant production

PADME strategy for the X_{17} search

[Darmé, Mancini, Nardi, Raggi, Phys. Rev. D 106 (2022) 11, 115036]

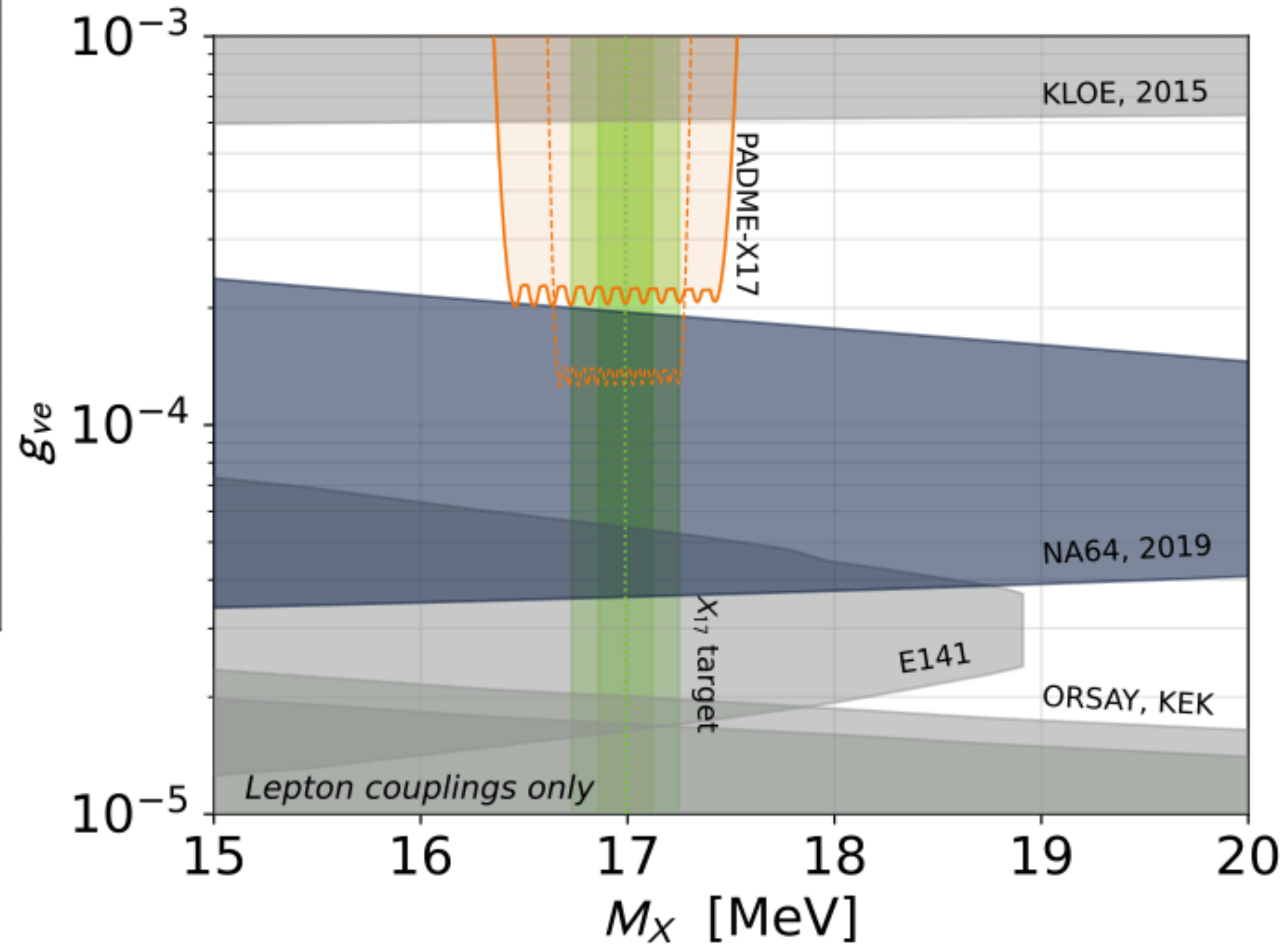
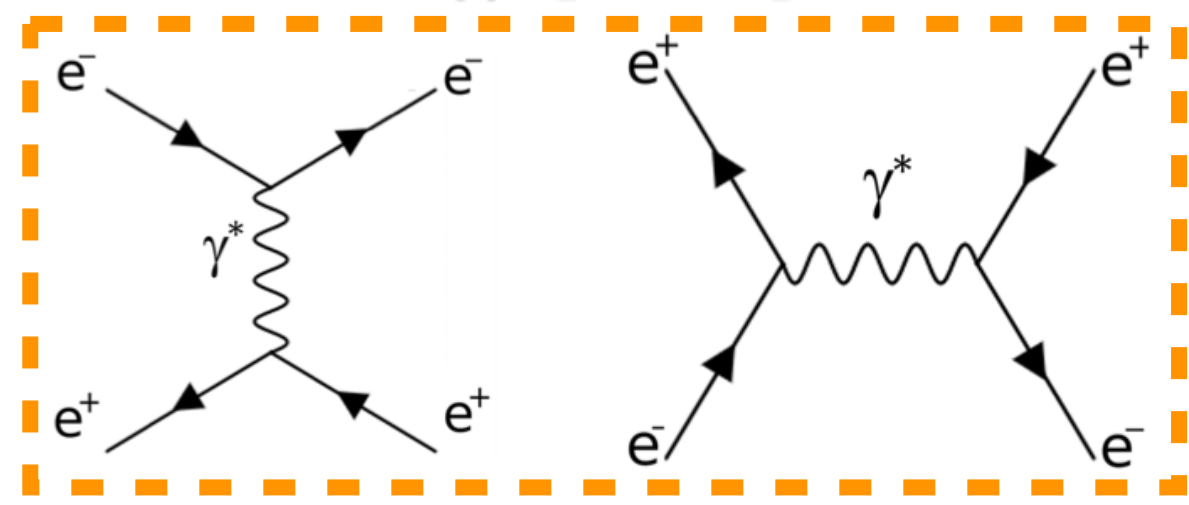
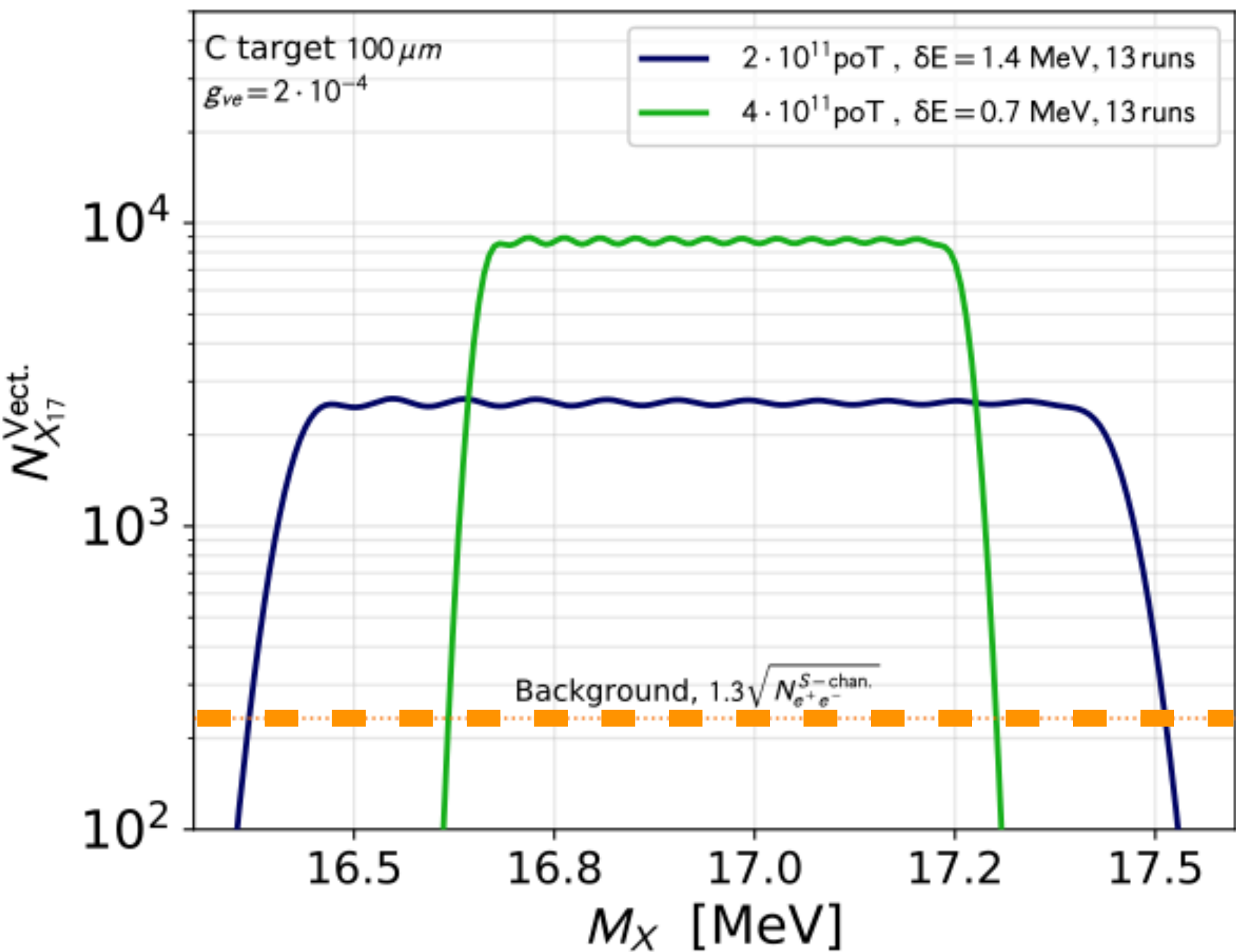

Free electrons at
rest approximation

Resonant production

Free electron at rest (FEAR) approximation

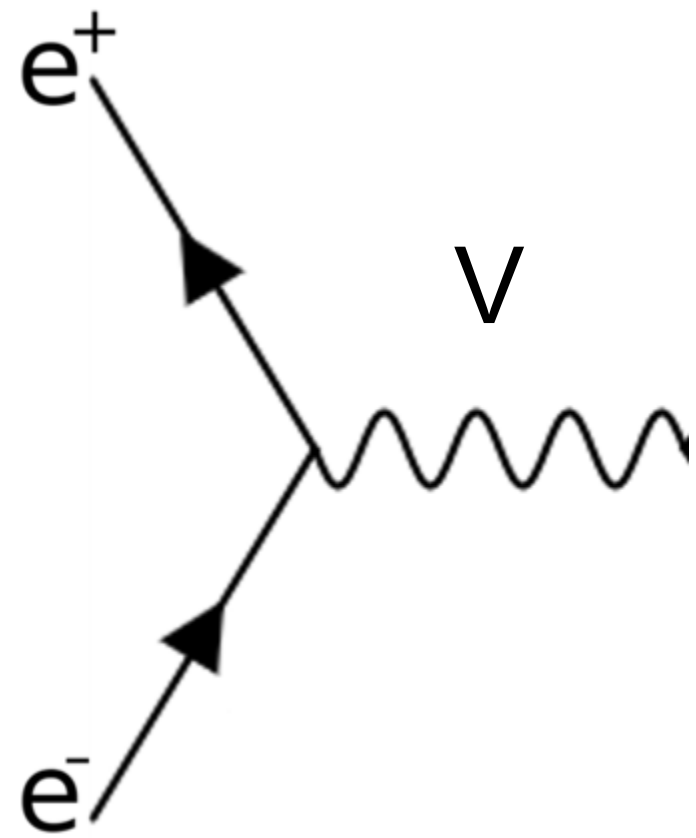

$$\sigma_{\text{res}}(E) \simeq \frac{\pi g_V^2}{2m_e} \mathcal{G}(E, E_{\text{res}}, \sigma_{E_B})$$

$$E_{\text{res}} = \frac{m_V^2}{2m_e} - m_e$$

Resonant production

Free electron at rest (FEAR) approximation

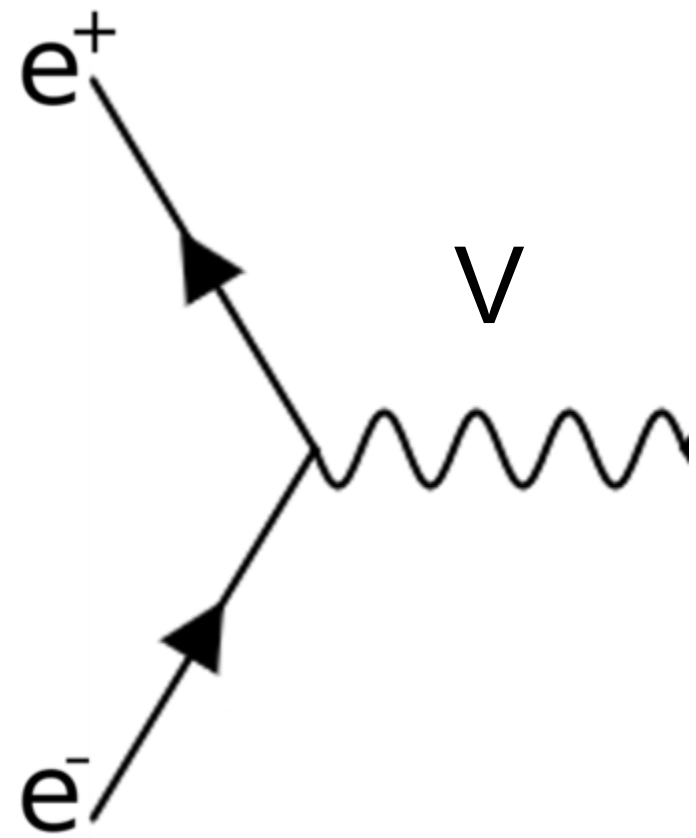

$$\sigma_{\text{res}}(E) \simeq \frac{\pi g_V^2}{2m_e} \mathcal{G}(E, E_{\text{res}}, \sigma_{E_B})$$

$$E_{\text{res}} = \frac{m_V^2}{2m_e} - m_e$$

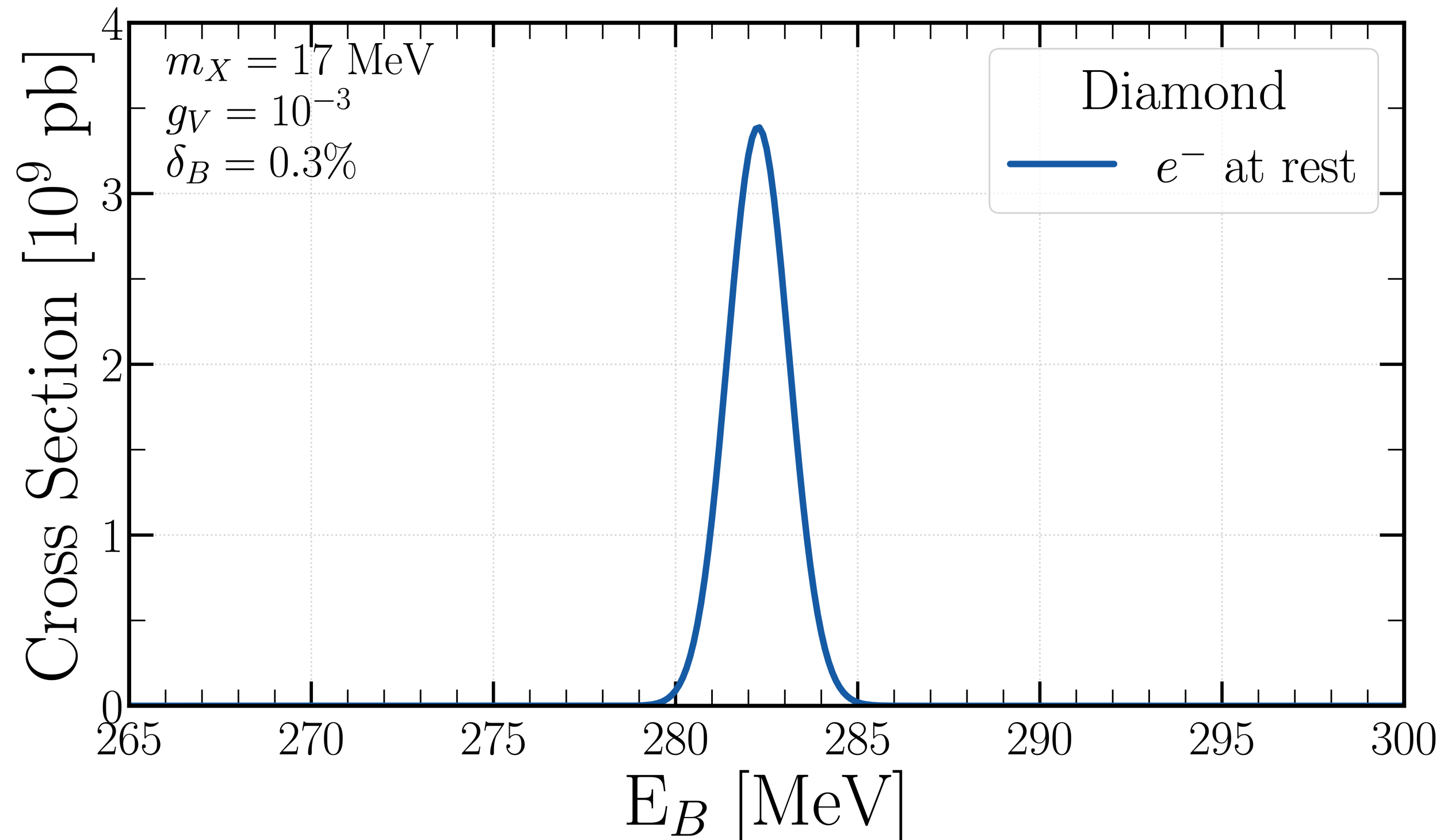

The problem

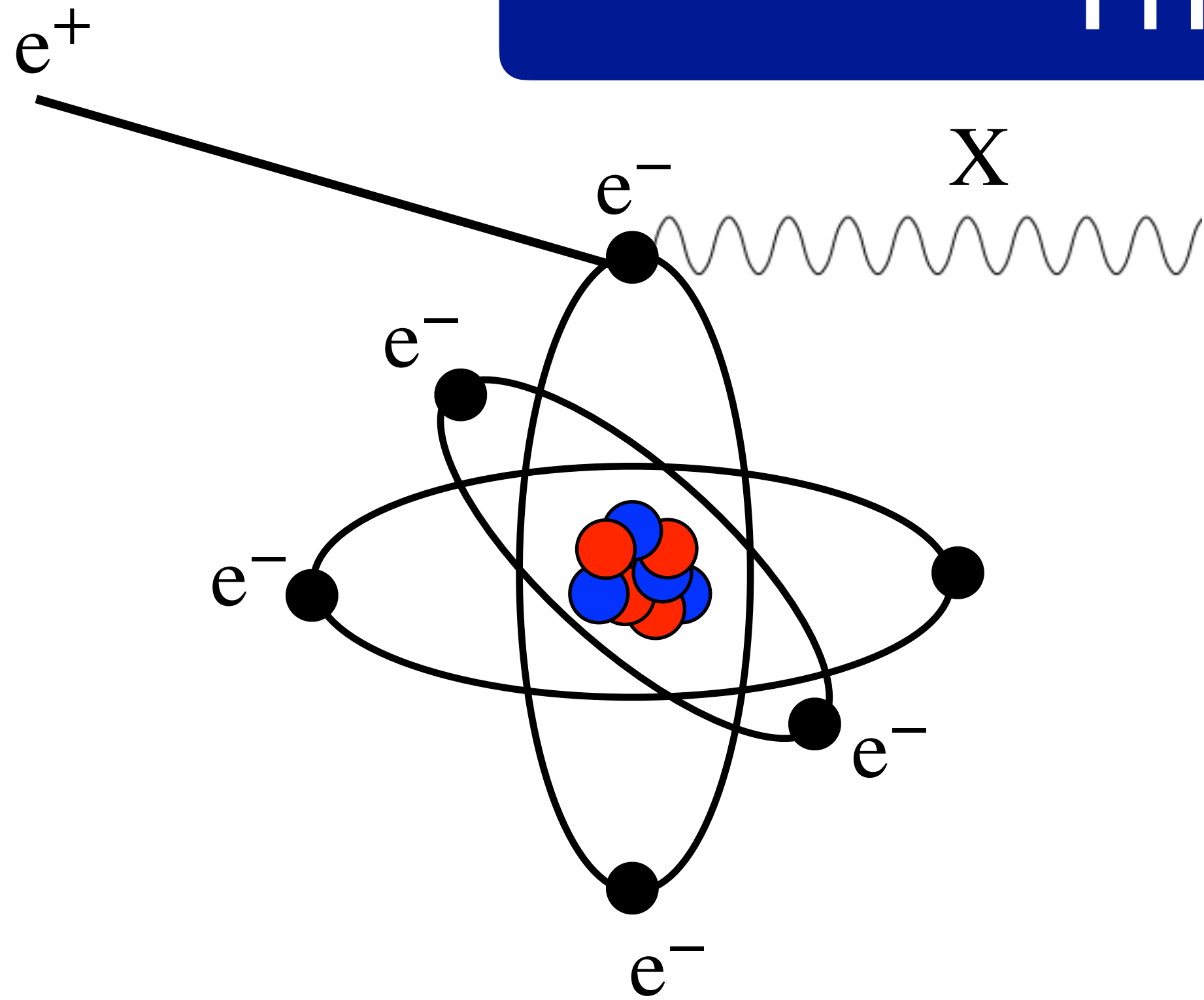

$$p^+ \simeq (E_b, E_b)$$

$$p^- = (m_e, \pm \gamma m_e \beta)$$

$$s' = m_e^2(2 - \beta^2 \gamma^2) + 2\gamma m_e E_b(1 \pm \beta)$$

The problem

[J. Chem. Phys. 47 (1967) 4 1300-1307]

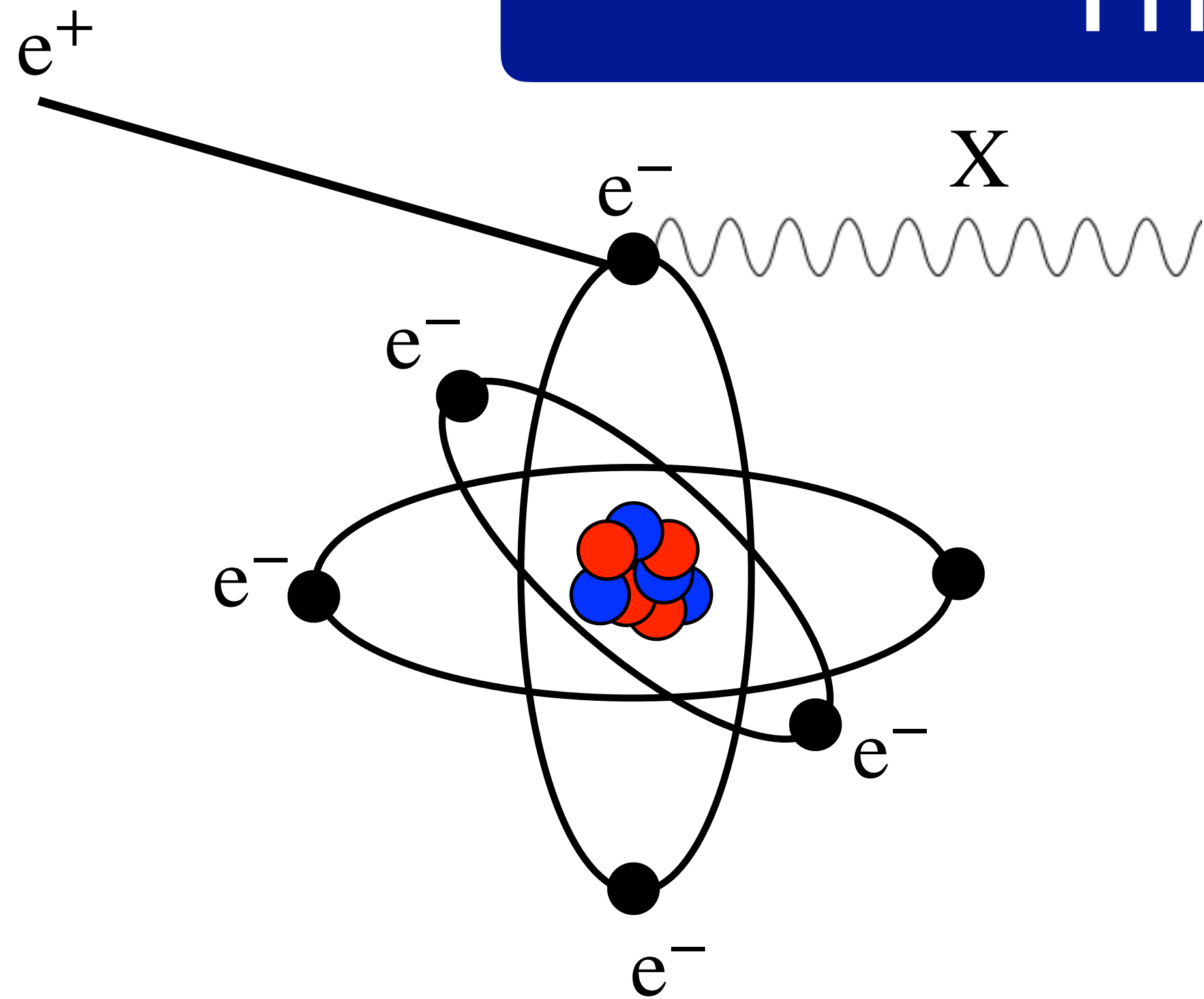

Naive estimate:

$$\langle \beta_{n\ell} \rangle = \alpha Z_{\text{eff}}^{n\ell}$$

$Z_{\text{eff}}^{1s} = 5.67$	$\langle \beta_{1s} \rangle = 0.041$
$Z_{\text{eff}}^{2s} = 3.22$	$\langle \beta_{2s} \rangle = 0.024$
$Z_{\text{eff}}^{2p} = 3.14$	$\langle \beta_{2p} \rangle = 0.023$

$$p^+ \simeq (E_b, E_b)$$

$$p^- = (m_e, \pm \gamma m_e \beta)$$

$$s' = m_e^2(2 - \beta^2 \gamma^2) + 2\gamma m_e E_b(1 \pm \beta)$$

The problem

[J. Chem. Phys. 47 (1967) 4 1300-1307]

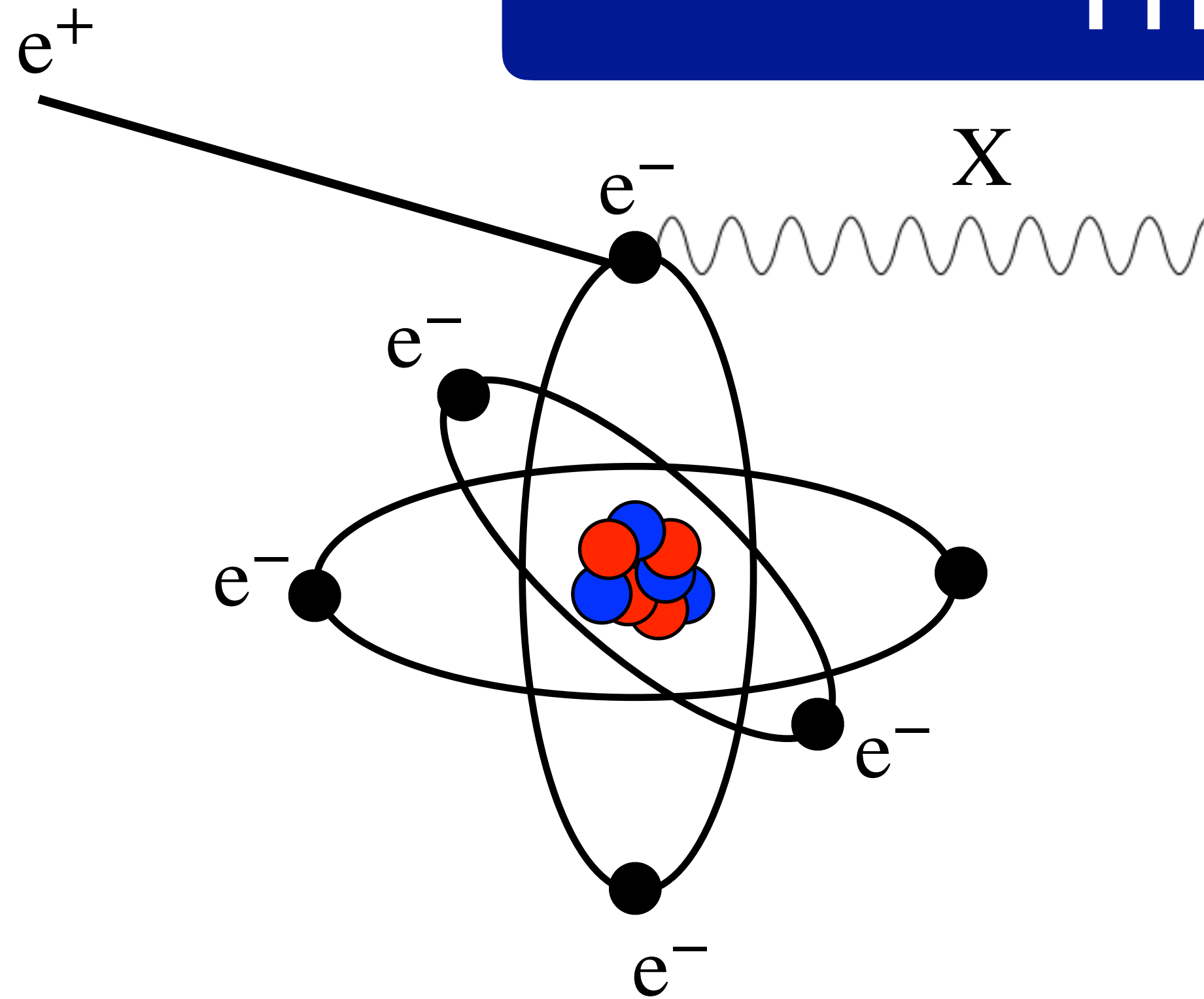

Naive estimate:

$$\langle \beta_{n\ell} \rangle = \alpha Z_{\text{eff}}^{n\ell}$$

$$\begin{array}{ll} Z_{\text{eff}}^{1s} = 5.67 & \langle \beta_{1s} \rangle = 0.041 \\ Z_{\text{eff}}^{2s} = 3.22 & \langle \beta_{2s} \rangle = 0.024 \\ Z_{\text{eff}}^{2p} = 3.14 & \langle \beta_{2p} \rangle = 0.023 \end{array}$$

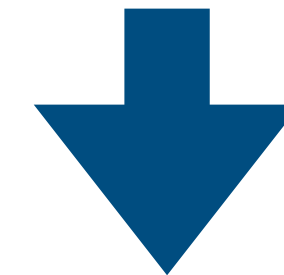

using $\beta = \langle \beta_{1s} \rangle = 0.04$

$$\begin{array}{ll} \sqrt{s} \simeq 17.0 \text{ MeV} & (E_b \sim 282.2 \text{ MeV}) \\ \sqrt{s'_+} = 17.3 \text{ MeV} & (E_b \sim 293.5 \text{ MeV}) \\ \sqrt{s'_-} = 16.7 \text{ MeV} & (E_b \sim 270.9 \text{ MeV}) \end{array}$$

The centre of mass energy for positron annihilation can differ sizeably with respect to the electrons at rest assumption!

$$\begin{aligned} p^+ &\simeq (E_b, E_b) \\ p^- &= (m_e, \pm \gamma m_e \beta) \\ s' &= m_e^2 (2 - \beta^2 \gamma^2) + 2\gamma m_e E_b (1 \pm \beta) \end{aligned}$$

Atomic electron motion

The cross-section

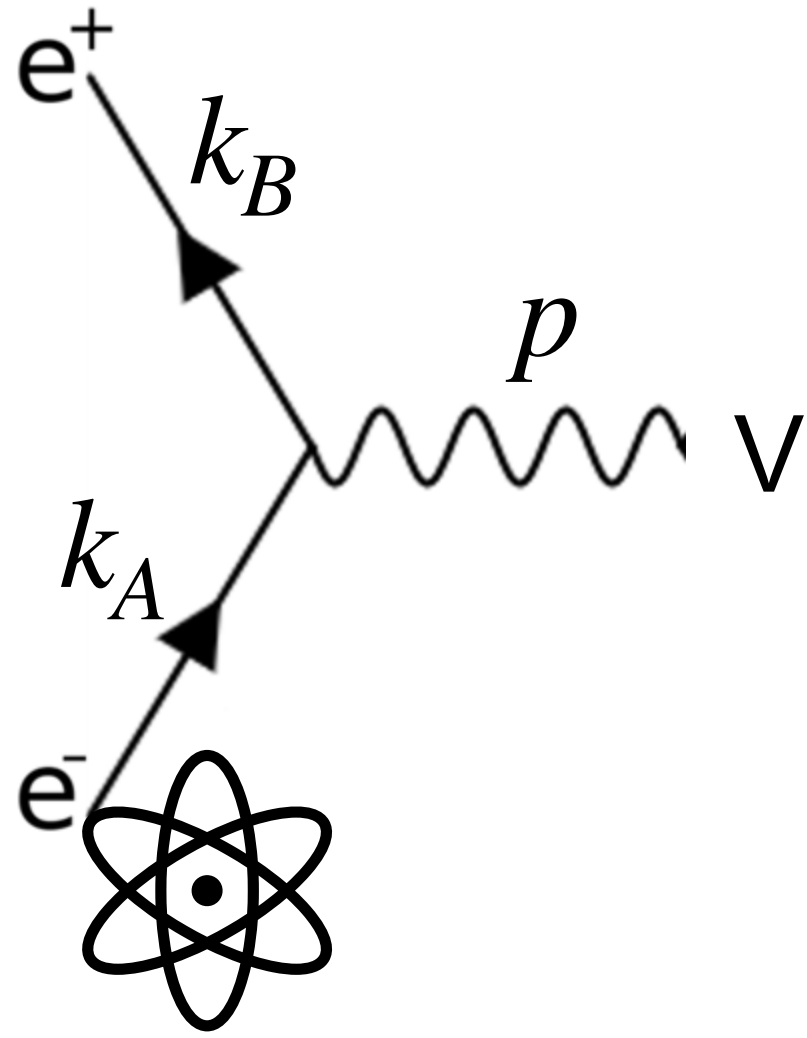

[Peskin-Schroeder (or any other text-book)]

$$d\sigma_q = \frac{d^3p}{(2\pi)^3} \int \frac{d^3k_A}{(2\pi)^3} \int \frac{d^3k_B}{(2\pi)^3} \frac{(2\pi)^4 \delta(E_A + E_B - E_X) \delta^{(3)}(\vec{k}_A + \vec{k}_B - \vec{p})}{2E_X 2E_{k_A} 2E_B |v_A - v_B|} \left| \phi_{A,q}(\vec{k}_A) \right|^2 \left| \mathcal{M}(k_A, k_B \rightarrow p) \right|^2 \left| \phi_B(\vec{k}_B) \right|^2$$

atomic electron quantum numbers

wave-functions

matrix element

Assumptions

1. Positrons in the beam as **free particles** with well defined momentum p_B

$$\int \frac{dk_B^3}{(2\pi)^3} \left| \phi_B(\vec{k}_B) \right|^2 = 1, \quad \left| \phi_B(\vec{k}_B) \right|^2 = (2\pi)^3 \delta^{(3)}(\vec{p}_B - \vec{k}_B)$$

Assumptions

1. Positrons in the beam as **free particles** with well defined momentum p_B

$$\int \frac{dk_B^3}{(2\pi)^3} \left| \phi_B(\vec{k}_B) \right|^2 = 1, \quad \left| \phi_B(\vec{k}_B) \right|^2 = (2\pi)^3 \delta^{(3)}(\vec{p}_B - \vec{k}_B)$$

2. **neglect the electron binding energy**

$$E_A \simeq m_e$$

Assumptions

1. Positrons in the beam as **free particles** with well defined momentum p_B

$$\int \frac{dk_B^3}{(2\pi)^3} \left| \phi_B(\vec{k}_B) \right|^2 = 1, \quad \left| \phi_B(\vec{k}_B) \right|^2 = (2\pi)^3 \delta^{(3)}(\vec{p}_B - \vec{k}_B)$$

2. **neglect the electron binding energy**

$$E_A \simeq m_e$$

3. **isotropic** electron momentum distribution

The cross-section

$$d\sigma = \frac{d^3 p_X}{(2\pi)^3} \int \frac{d^3 k_A}{(2\pi)^3} \frac{(2\pi)^4}{8E_X E_{k_A} E_B |v_A - v_B|} n(\vec{k}_A) |\mathcal{M}|^2 \delta(E_A + E_B - E_X) \delta^{(3)}(\vec{k}_A + \vec{p}_B - \vec{p}_X)$$

$$n(\vec{k}_A) = \sum_{n,\ell} |\phi_{n,\ell}(\vec{k}_A)|^2$$

The cross-section

$$d\sigma = \frac{d^3 p_X}{(2\pi)^3} \int \frac{d^3 k_A}{(2\pi)^3} \frac{(2\pi)^4}{8E_X E_{k_A} E_B |v_A - v_B|} n(\vec{k}_A) |\mathcal{M}|^2 \delta(E_A + E_B - E_X) \delta^{(3)}(\vec{k}_A + \vec{p}_B - \vec{p}_X)$$

$$n(\vec{k}_A) = \sum_{n,\ell} |\phi_{n,\ell}(\vec{k}_A)|^2$$

theory

use Slater Type Orbitals,
hybridization, Hartree Fock
computations for atomic carbon, ...

The cross-section

$$d\sigma = \frac{d^3 p_X}{(2\pi)^3} \int \frac{d^3 k_A}{(2\pi)^3} \frac{(2\pi)^4}{8E_X E_{k_A} E_B |v_A - v_B|} n(\vec{k}_A) |\mathcal{M}|^2 \delta(E_A + E_B - E_X) \delta^{(3)}(\vec{k}_A + \vec{p}_B - \vec{p}_X)$$

$$n(\vec{k}_A) = \sum_{n,\ell} |\phi_{n,\ell}(\vec{k}_A)|^2$$

theory

use Slater Type Orbitals, hybridization, Hartree Fock computations for atomic carbon, ...

data

obtain $n(k)$ from data: Compton Profile

Compton Profile

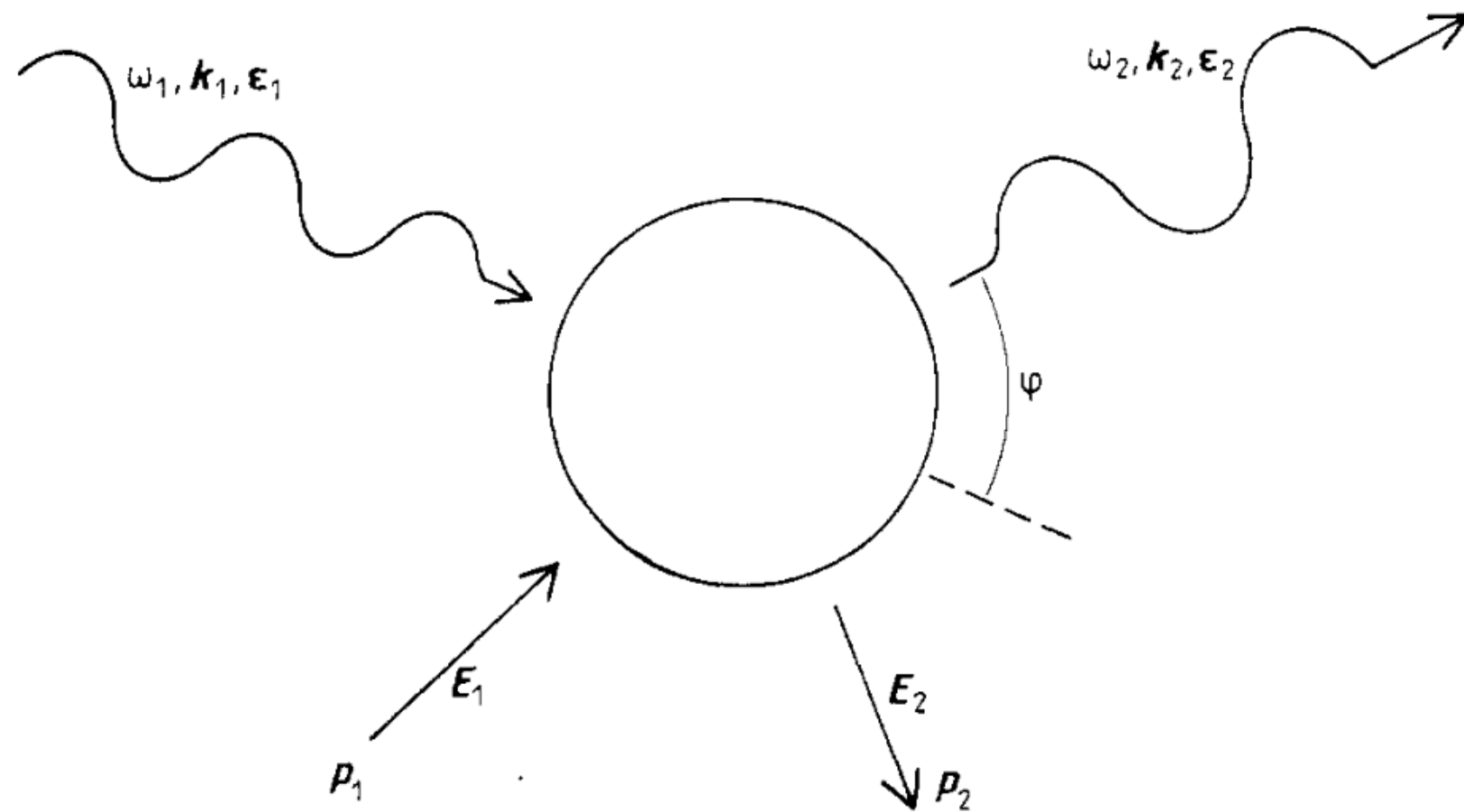

$$\begin{aligned}\omega_1 - \omega_2 &= \frac{1}{2}m_e [\vec{p} + (\vec{k}_1 - \vec{k}_2)]^2 - \frac{|\vec{p}|^2}{2m_e} \\ &= \frac{|\vec{k}_1 - \vec{k}_2|^2}{2m_e} + \frac{(\vec{k}_1 - \vec{k}_2) \cdot \vec{p}}{m_e} \\ &\simeq \frac{2\omega_1}{m_e} \sin(\phi/2)p_z\end{aligned}$$

Compton Profile

M J Cooper 1985 Rep. Prog. Phys. 48 415

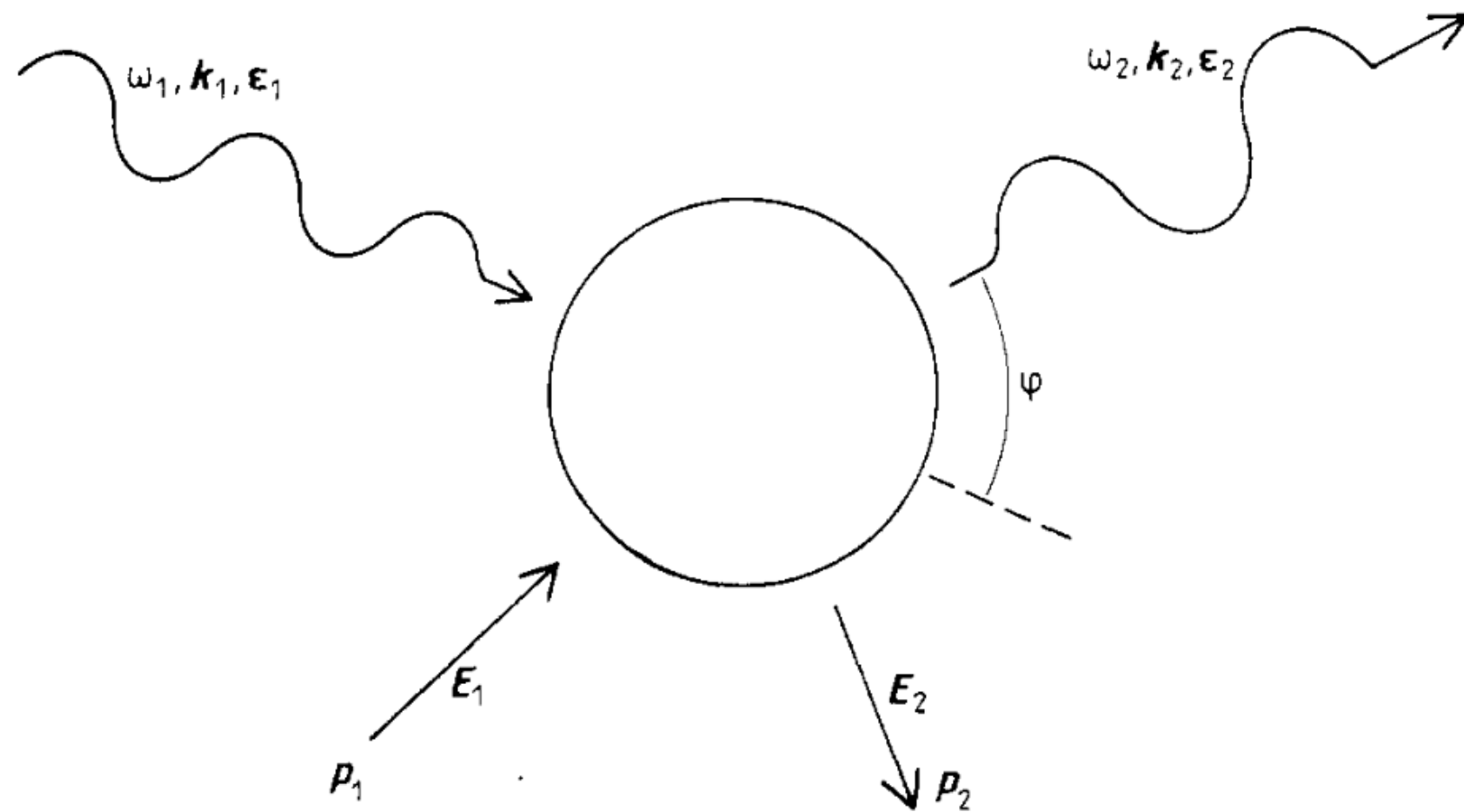

$$\begin{aligned} \omega_1 - \omega_2 &= \frac{1}{2}m_e [\vec{p} + (\vec{k}_1 - \vec{k}_2)]^2 - \frac{|\vec{p}|^2}{2m_e} \\ &= \frac{|\vec{k}_1 - \vec{k}_2|^2}{2m_e} + \frac{(\vec{k}_1 - \vec{k}_2) \cdot \vec{p}}{m_e} \\ &\simeq \frac{2\omega_1}{m_e} \sin(\phi/2)p_z \end{aligned}$$

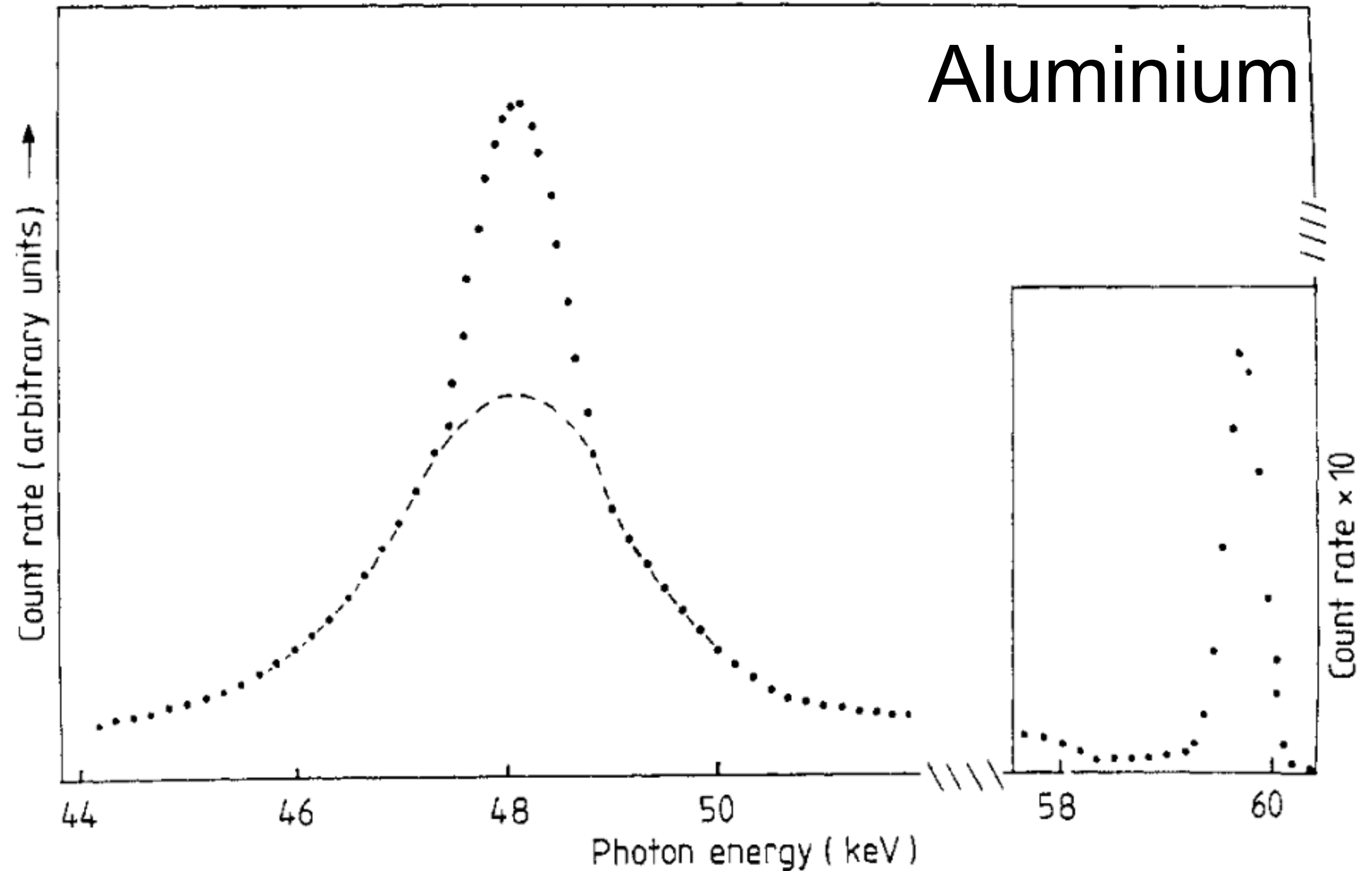

Compton Profile

The Compton Profile is the Radon transform of the electronic momentum distribution along the scattering vector k_z

$$J(k_z) = \iint dk_x dk_y n(k_x, k_y, k_z)$$

assuming
isotropy

$$J(q) = \frac{1}{4\pi^2} \int_{|q|}^{\infty} n(k) k dk \quad \Downarrow \quad \int_{-\infty}^{+\infty} J(q) dq = Z$$

$$n(k) = -\frac{(2\pi)^2}{k} \left| \frac{dJ(k)}{dk} \right|$$

Data and theory

X-Ray determination of the Electron Momentum Density in Diamond, Graphite and Carbon Black
[Phys. Rev. 176 (1968) 900]

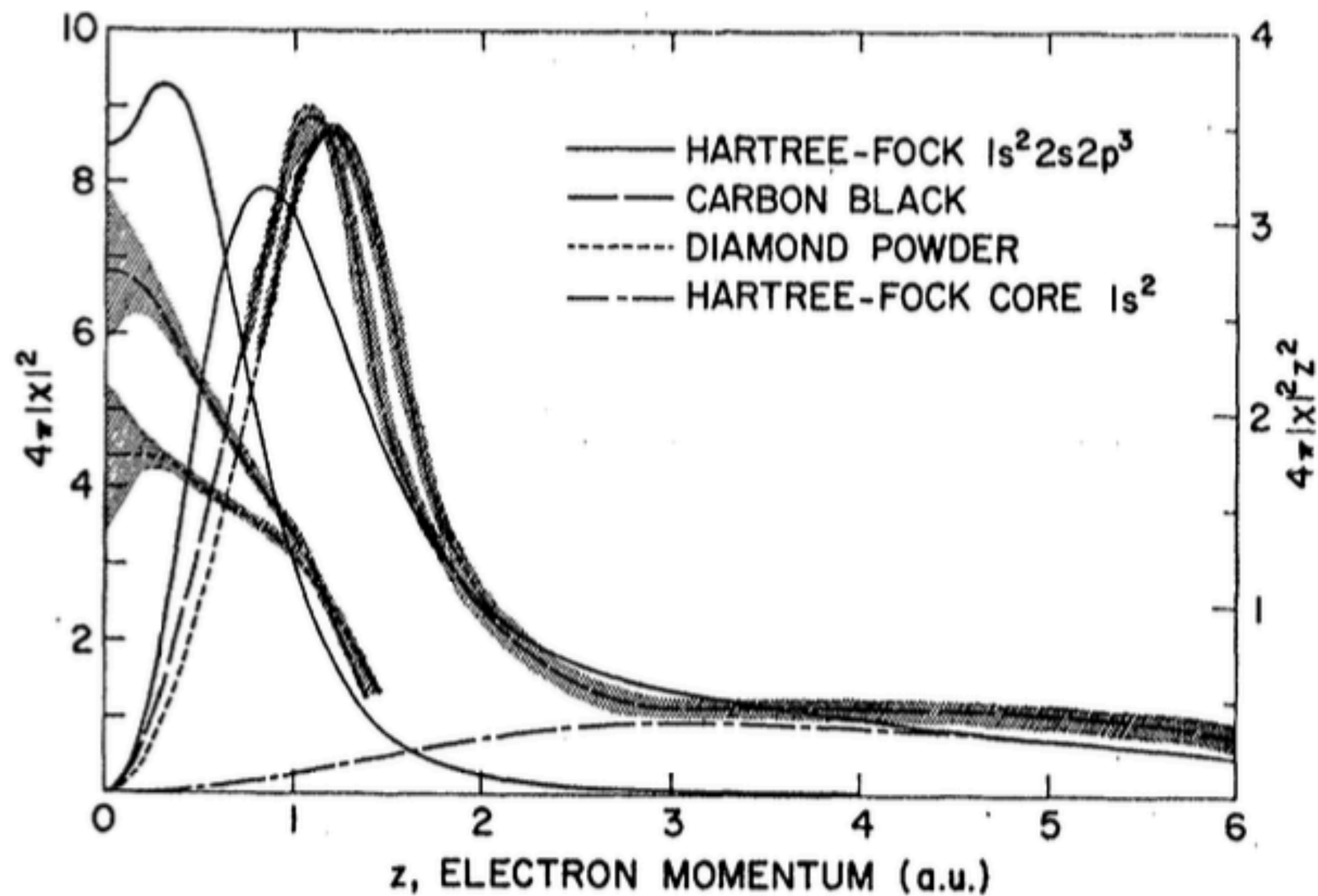

Theoretical Compton profile of diamond, boron nitride and carbon nitride
[Physica B 521 (2017) 361-364]

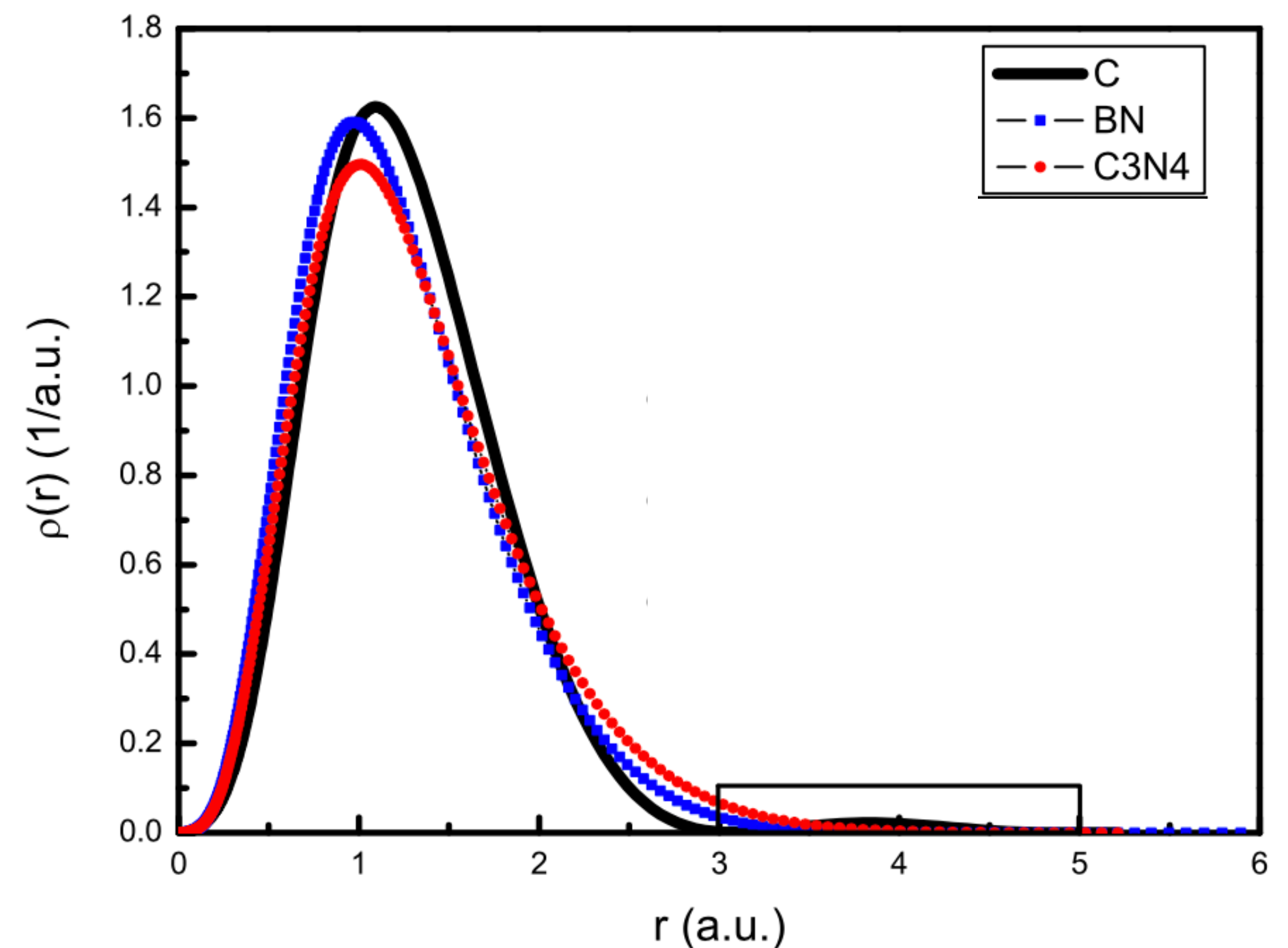

Comparison

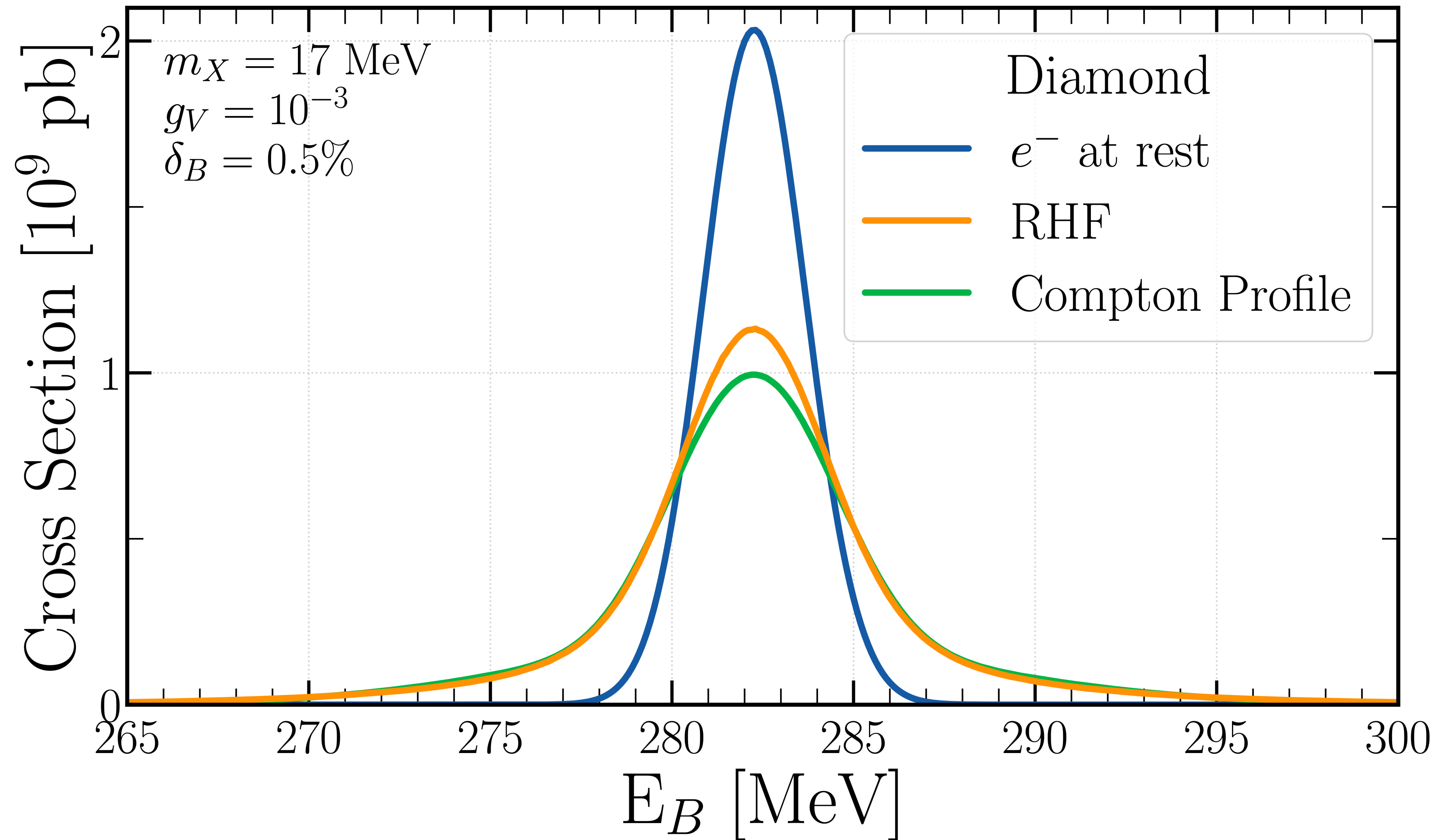

Comparison

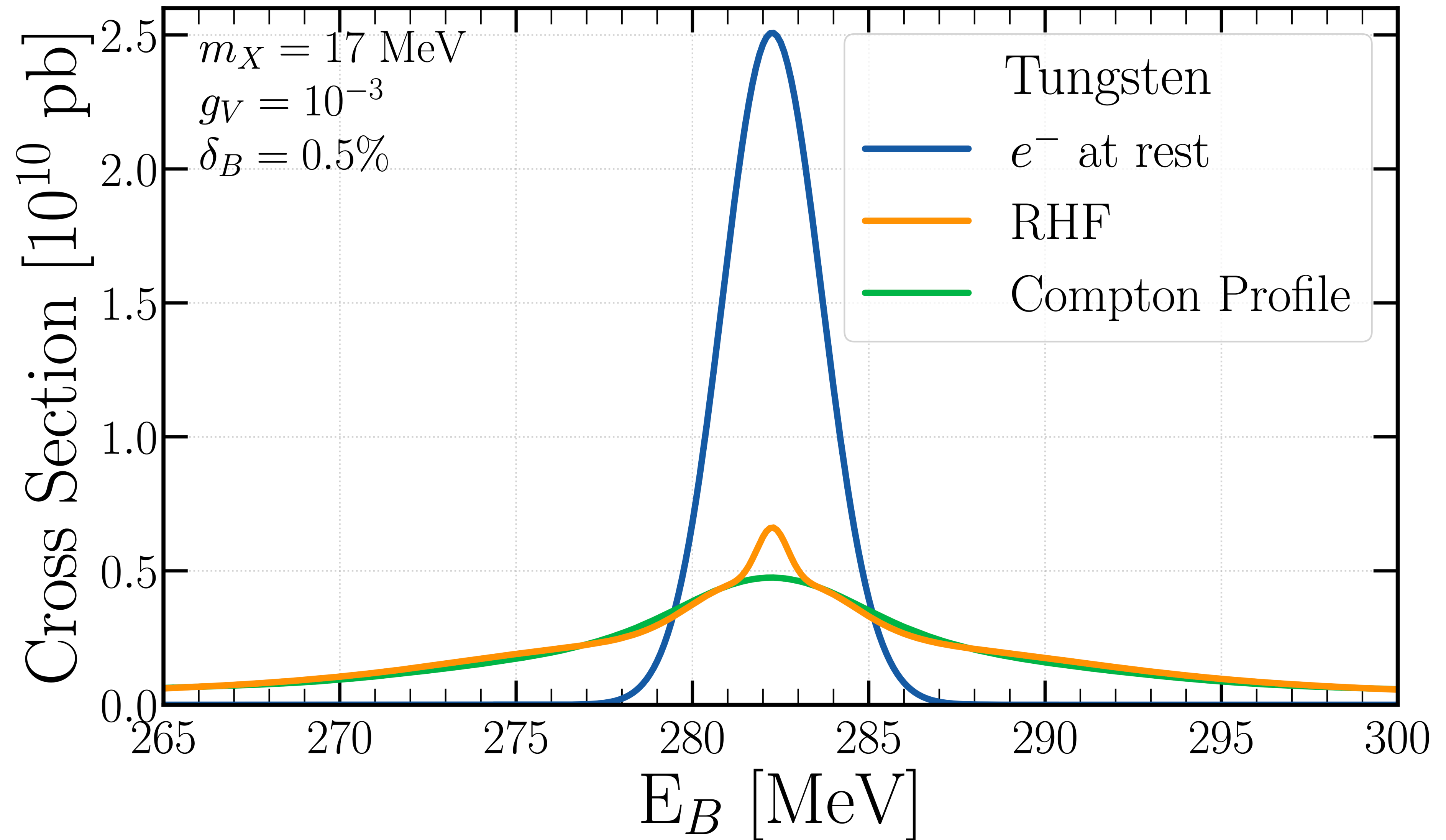

Atoms as electron
accelerators: new
physics

X17 sensitivity @PADME

[Arias-Aragon, Darmé, G²dC,
Nardi, PRL 132(2024)261801,
arXiv:2403.15387]

$$\mathcal{L} \supset -i g_V \bar{\psi}_e \gamma^\mu \psi_e V_\mu$$

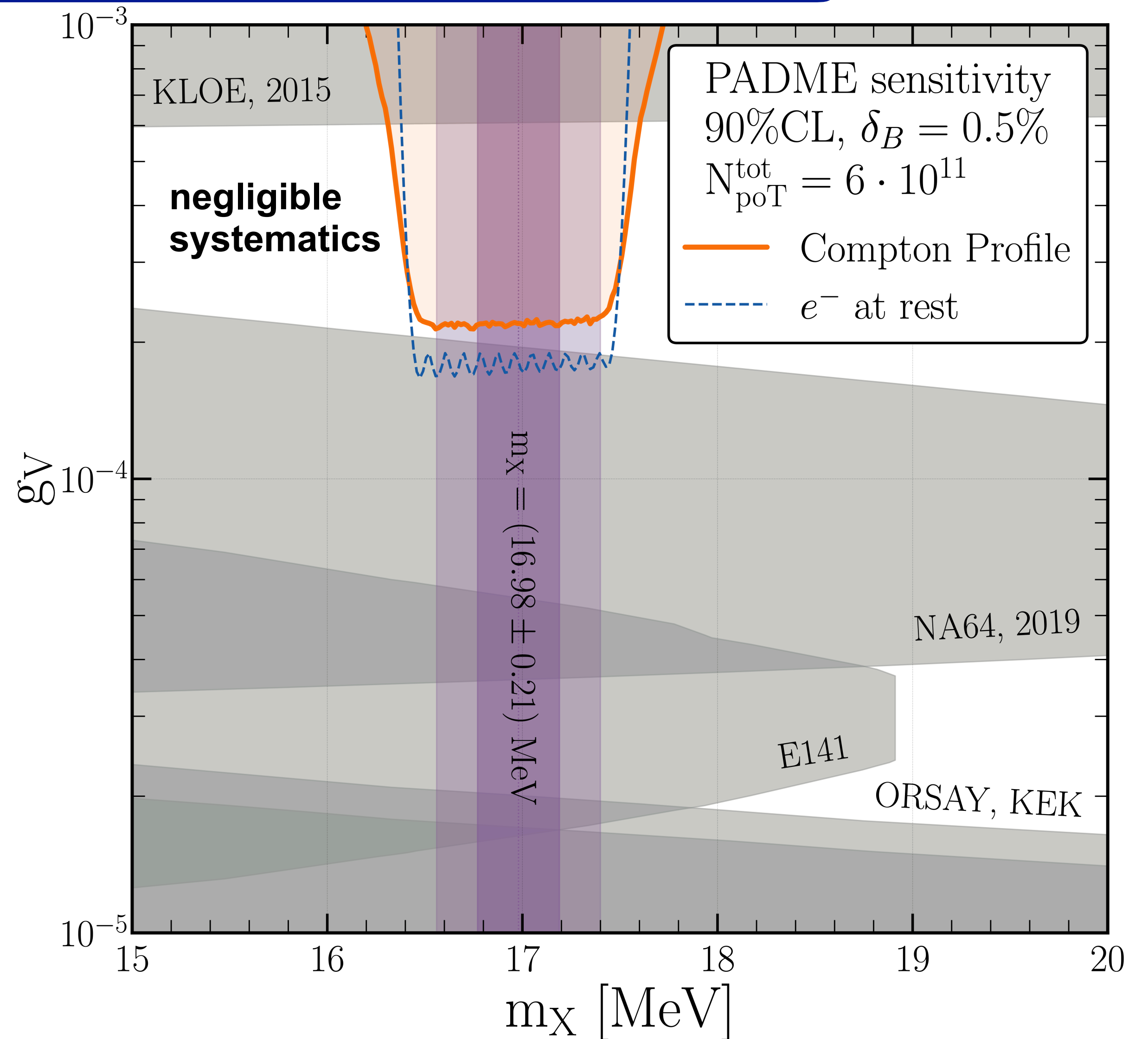

Dark photons

[Arias-Aragon, Darmé, G²dC,
Nardi, Veissière, in preparation]

$$\mathcal{L} \supset -i\epsilon e \bar{\psi}_e \gamma^\mu \psi_e A'_\mu$$

5 cm tungsten thick target
LNF: 450 MeV, $10^{18} e^+ oT$

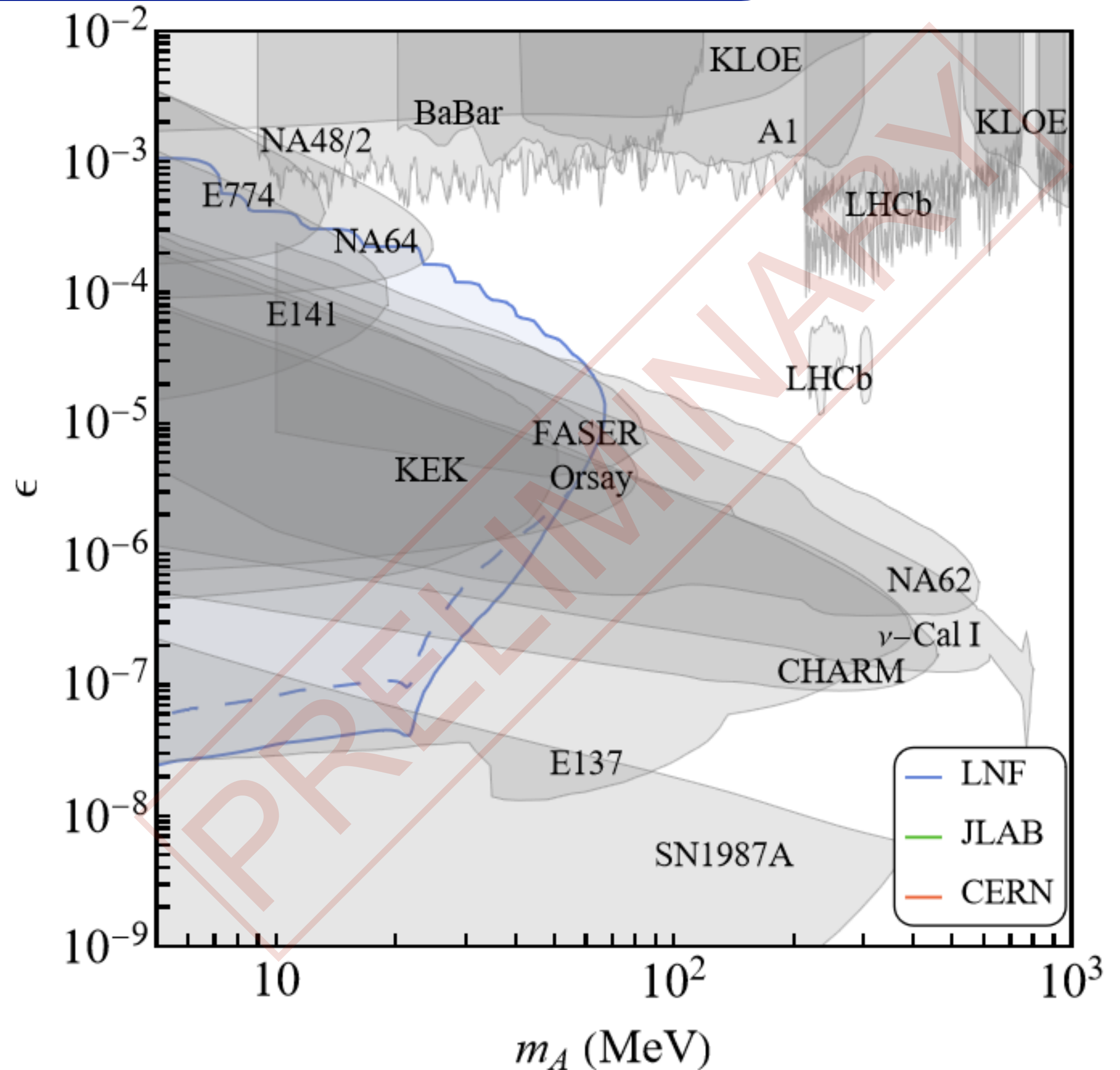

Dark photons

[Arias-Aragon, Darmé, G²dC,
Nardi, Veissière, in preparation]

$$\mathcal{L} \supset -i\epsilon e \bar{\psi}_e \gamma^\mu \psi_e A'_\mu$$

5 cm tungsten thick target

LNF: 450 MeV, $10^{18} e^+ oT$

JLAB: 12 GeV, $10^{21} e^+ oT$

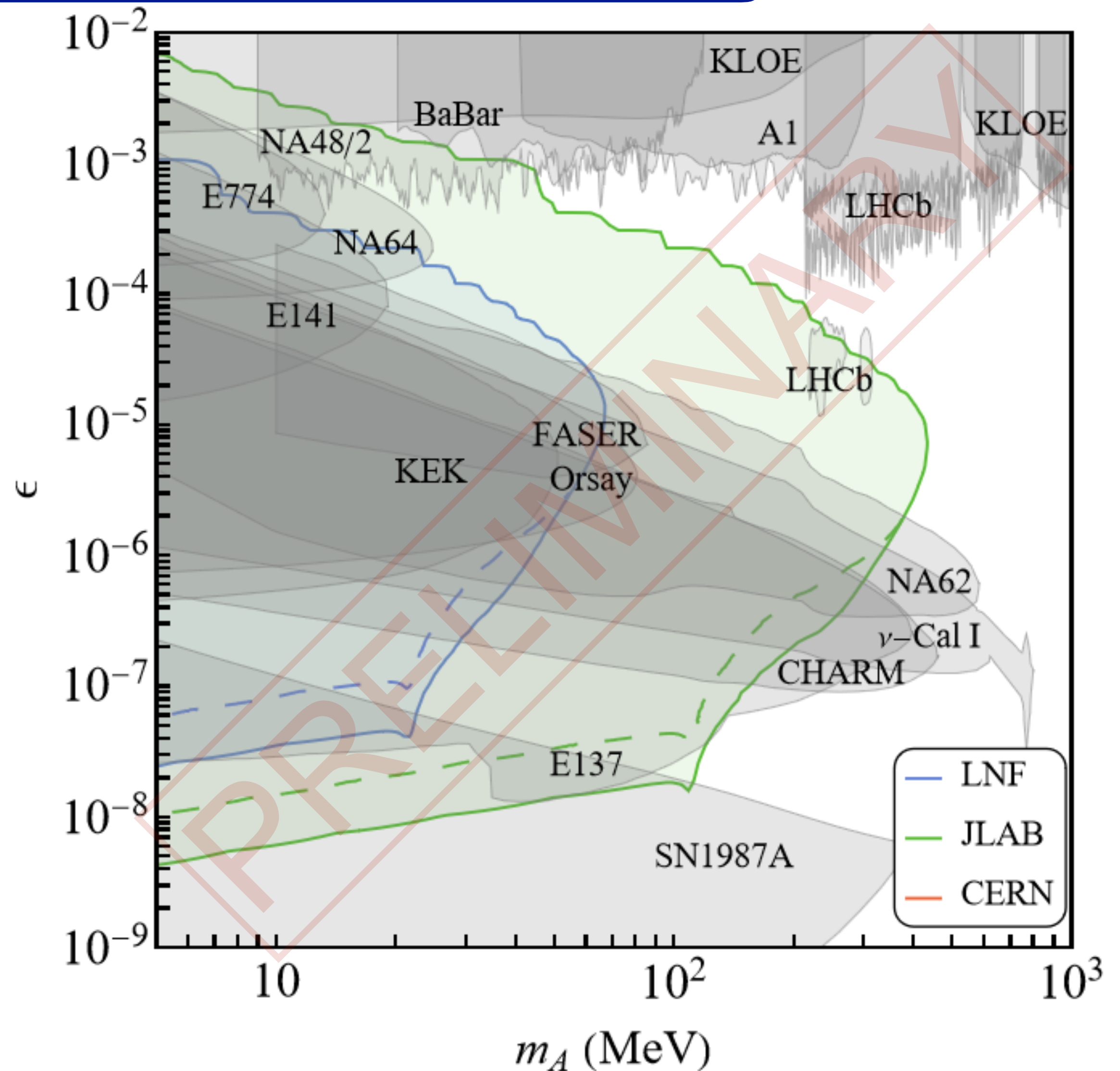

Dark photons

[Arias-Aragon, Darmé, G²dC,
Nardi, Veissière, in preparation]

$$\mathcal{L} \supset -i\epsilon e \bar{\psi}_e \gamma^\mu \psi_e A'_\mu$$

5 cm tungsten thick target

LNF: 450 MeV, $10^{18} e^+ oT$

JLAB: 12 GeV, $10^{21} e^+ oT$

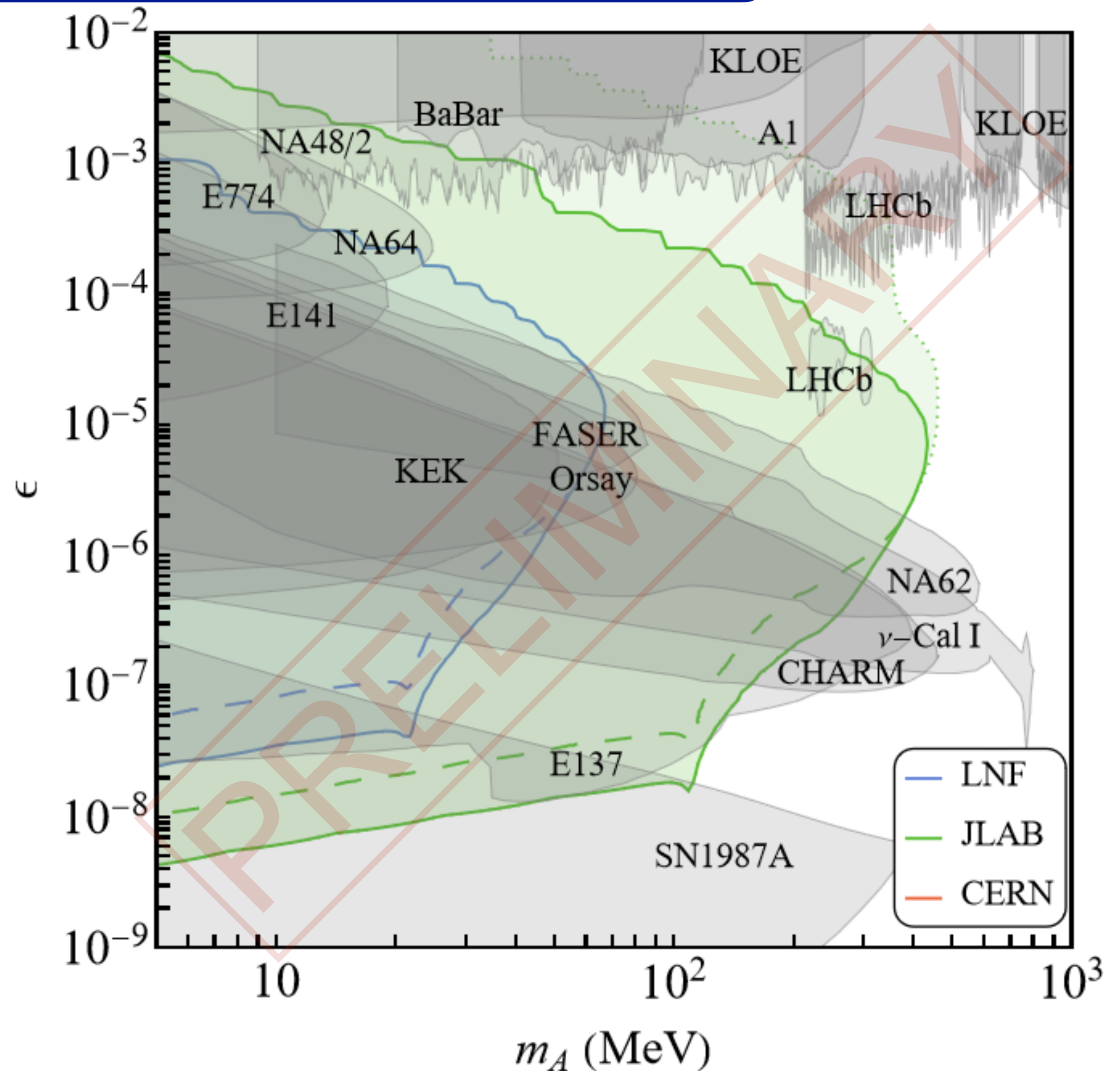

Dark photons

[Arias-Aragon, Darmé, G²dC,
Nardi, Veissière, in preparation]

$$\mathcal{L} \supset -i\epsilon e \bar{\psi}_e \gamma^\mu \psi_e A'_\mu$$

5 cm tungsten thick target

LNF: 450 MeV, $10^{18} e^+ oT$

JLAB: 12 GeV, $10^{21} e^+ oT$

CERN: 100 GeV, $10^{16} e^+ oT$

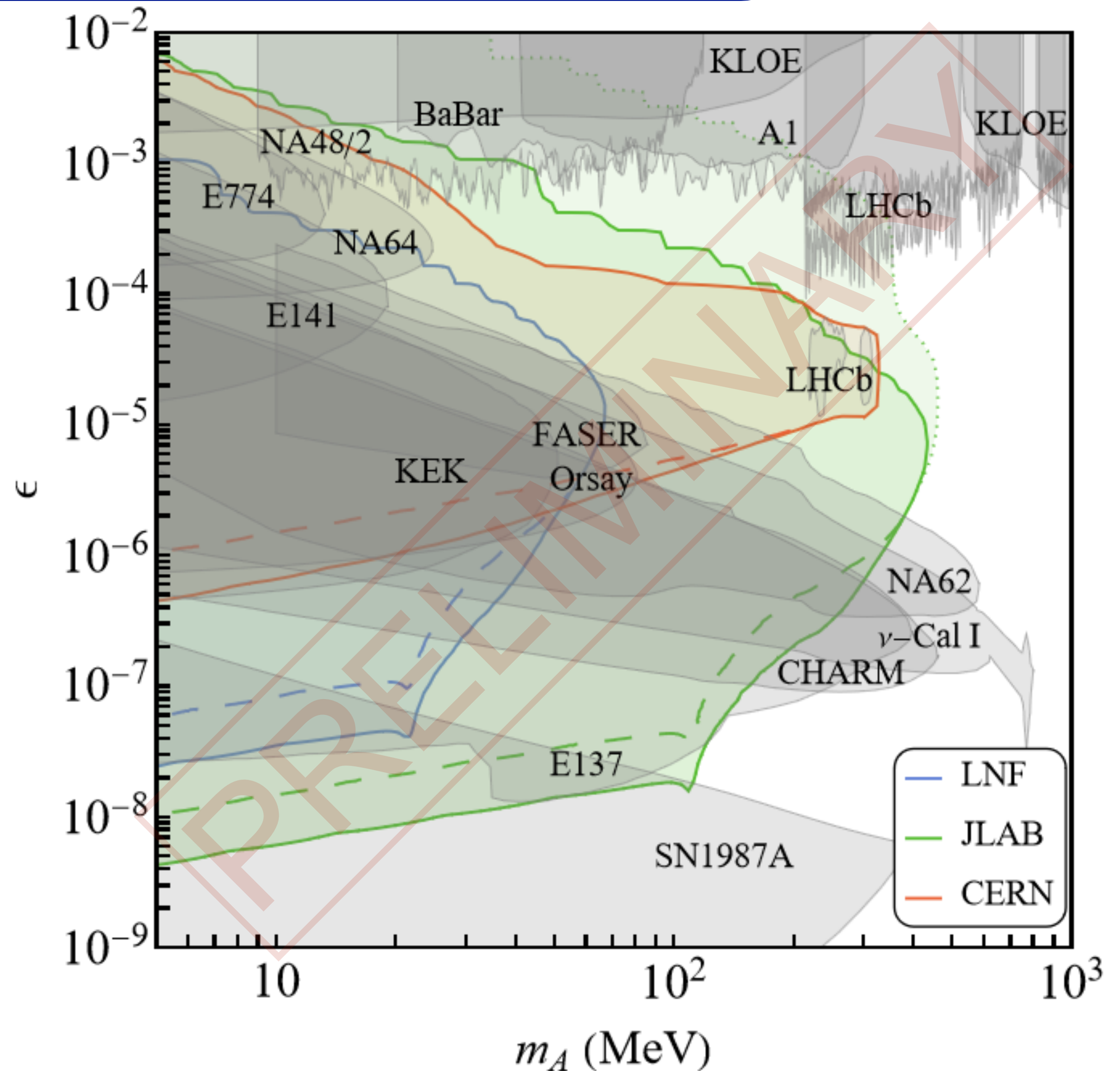

Atoms as electron
accelerators: σ_{had}

The muon magnetic moment

[Muon g-2 Coll. *Phys.Rev.D* 110 (2024) 3, 032009]

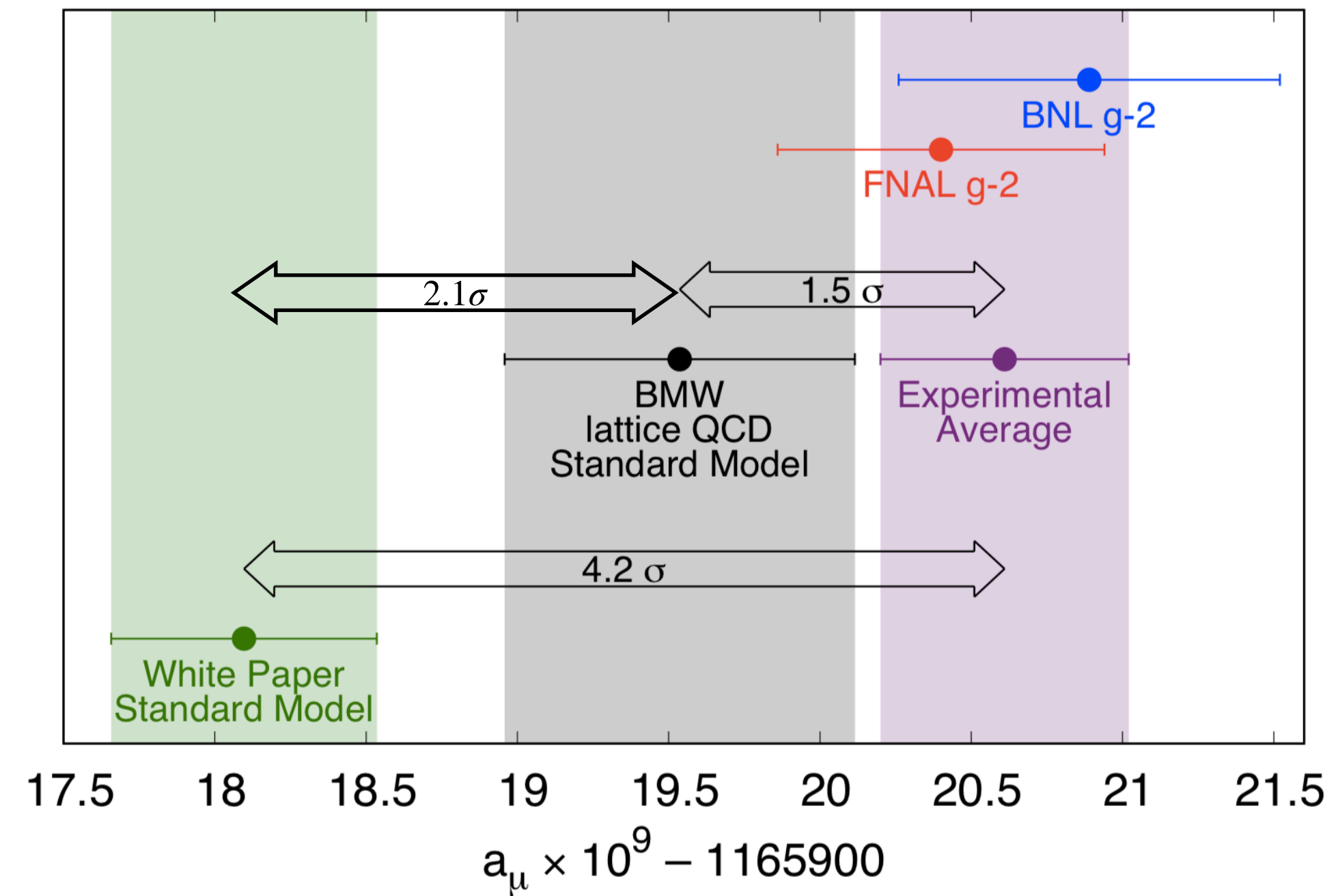
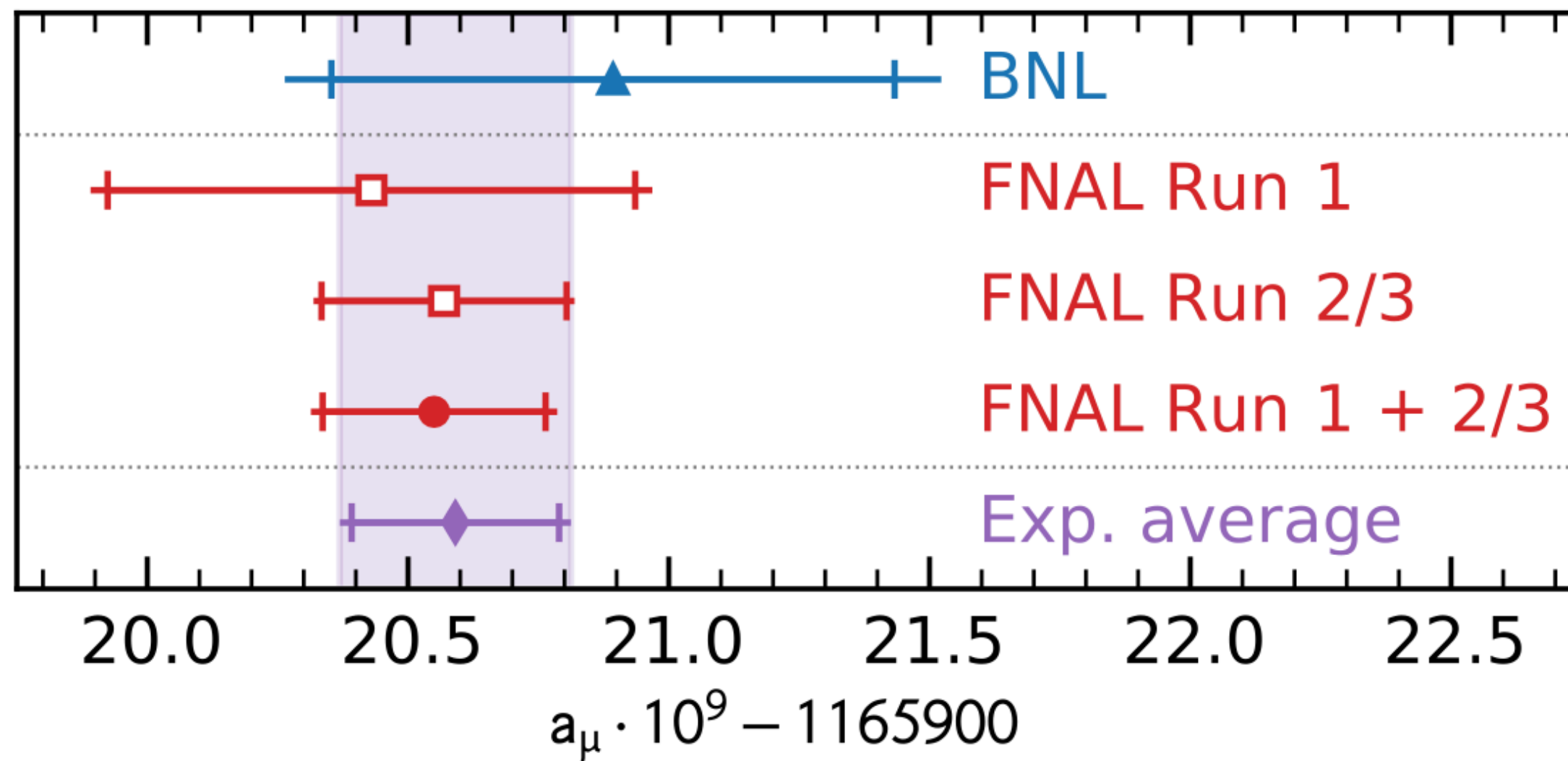

$$a_\mu^{\text{exp}} = (116592059 \pm 22) \cdot 10^{-11}$$

The muon magnetic moment

[Aoyama et al, 2006.04822, Phys. Rept. 887 (2020) 1-166]

$$116584718.9(1) \cdot 10^{-11}$$

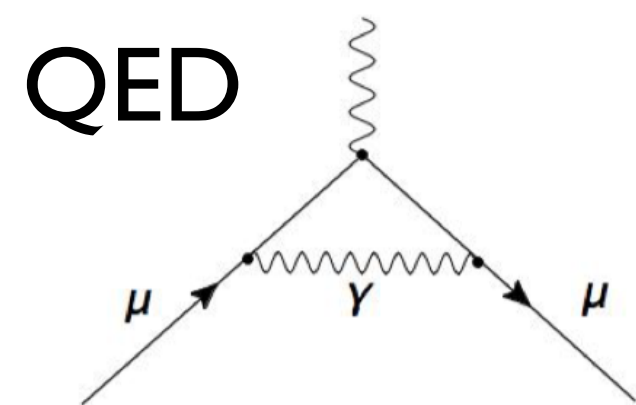

$$6845(40) \cdot 10^{-11}$$

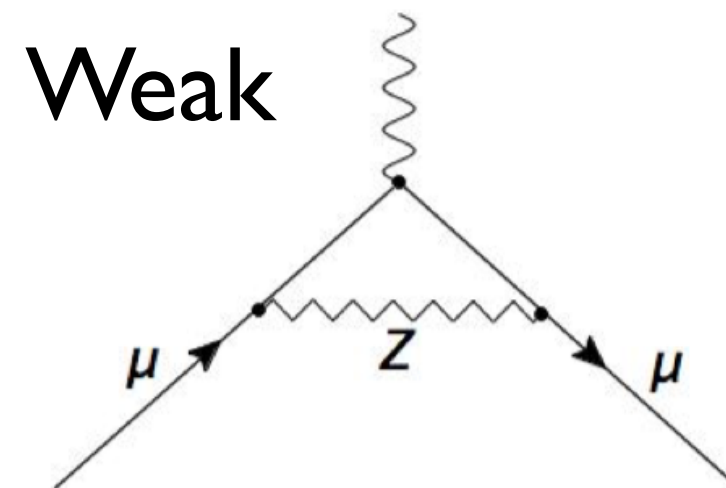

Hadronic vacuum polarization

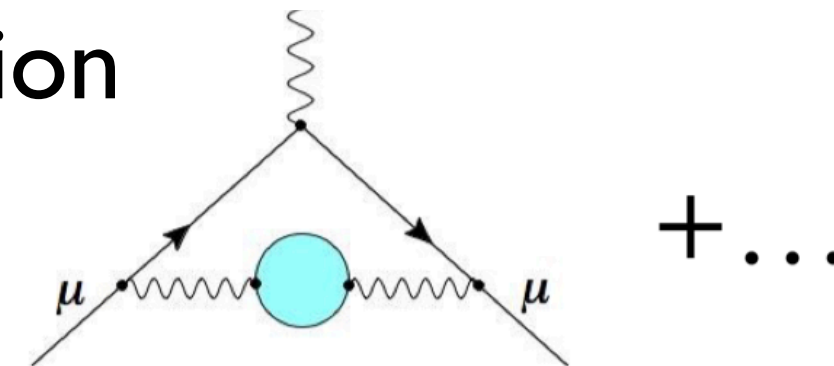

Hadronic light-by-light

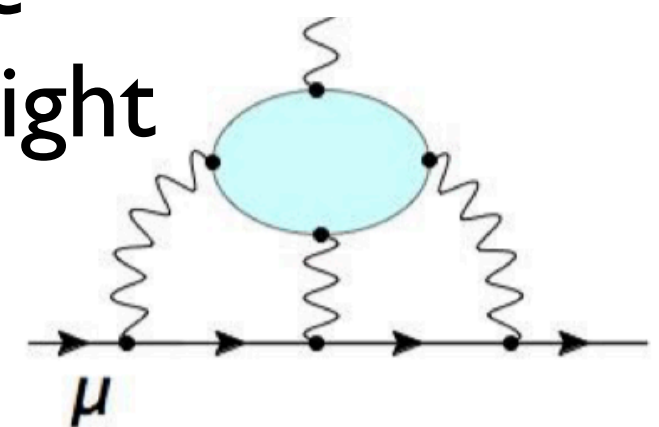

$$153.6(1.0) \cdot 10^{-11}$$

$$92(18) \cdot 10^{-11}$$

Hadronic cross section

Hadronic vacuum polarization

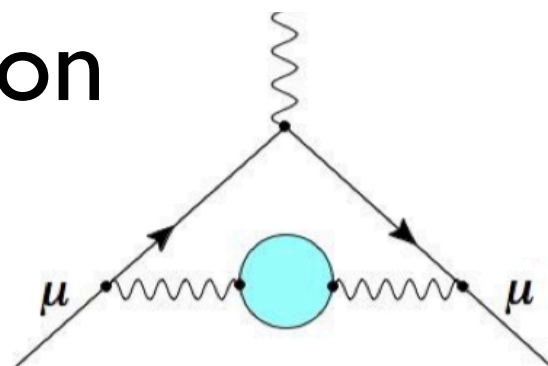

$$6845(40) \cdot 10^{-11}$$

$$a_{\mu}^{HVP} = \frac{1}{4\pi^3} \int_{s_{th}} ds \sigma_{had}(s) K(s)$$

σ_{had} measured at colliders

1. employing a scanning method
2. employing the radiative return method

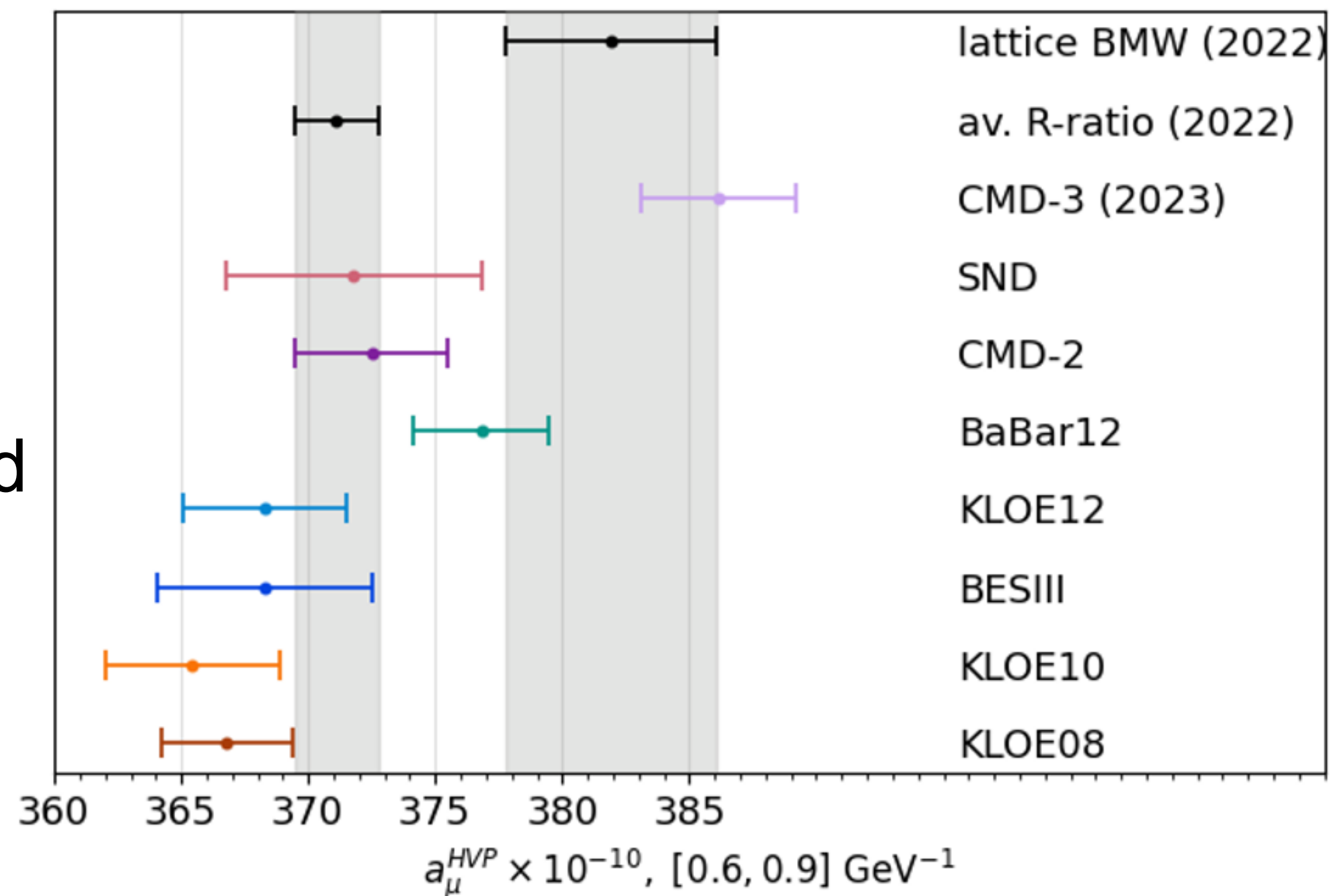

Hadronic cross section

PROPOSAL:

[Arias-Aragon, Darmé, G²dC, Nardi, 2407.15941]

Positron annihilation on atomic electrons of a fixed target with high Z (e.g. ^{92}U), in which the $\sigma_{\text{had}}(s)$ energy dependence is scanned by taking advantage of the relativistic electron velocity of the inner atomic shells.

Hadronic cross section

Two possible beam-lines:

1. JLAB: $E_B = 12 \text{ GeV}$, $10^{21} e^+oT$
2. CERN H4 beam-line: $E_B = (100 - 200) \text{ GeV}$,
 $(2.3 - 0.2) \times 10^{13} e^+oT$

[Arias-Aragon, Darmé, G²dC, Nardi, 2407.15941]

$$\sigma_{\text{had}} \simeq \sigma_{\pi\pi} = \frac{N_{\pi\pi}}{N_{\mu\mu}} \sigma_{\mu\mu}^0$$

Hadronic cross section

Two possible beam-lines:

1. JLAB: $E_B = 12 \text{ GeV}$, $10^{21} e^+oT$
2. CERN H4 beam-line: $E_B = (100 - 200) \text{ GeV}$, $(2.3 - 0.2) \times 10^{13} e^+oT$

[Arias-Aragon, Darmé, G²dC, Nardi, 2407.15941]

$$\sigma_{\text{had}} \simeq \sigma_{\pi\pi} = \frac{N_{\pi\pi}}{N_{\mu\mu}} \sigma_{\mu\mu}^0$$

KLOE = $N_{\mu\mu\gamma}$ [Phys. Lett. B 720 (2013) 336-343]

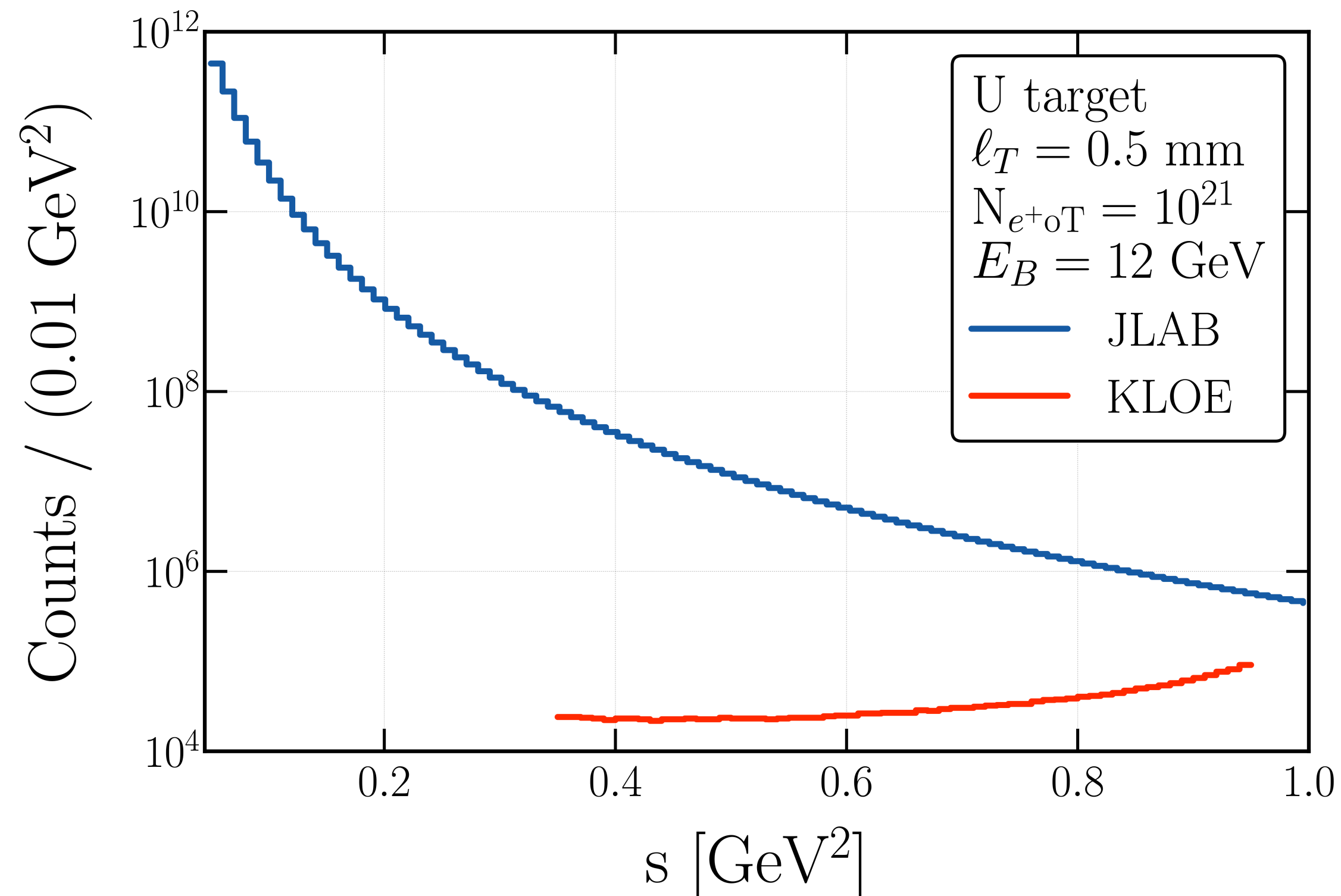

Hadronic cross section

Two possible beam-lines:

1. JLAB: $E_B = 12 \text{ GeV}$, $10^{21} e^+ oT$
2. CERN H4 beam-line: $E_B = (100 - 200) \text{ GeV}$, $\mathcal{O}(10^{16}) e^+ oT$ needed

[Arias-Aragon, Darmé, G^2dC , Nardi, 2407.15941]

$$\sigma_{\text{had}} \simeq \sigma_{\pi\pi} = \frac{N_{\pi\pi}}{N_{\mu\mu}} \sigma_{\mu\mu}^0$$

KLOE = $N_{\mu\mu\gamma}$ [Phys. Lett. B 720 (2013) 336-343]

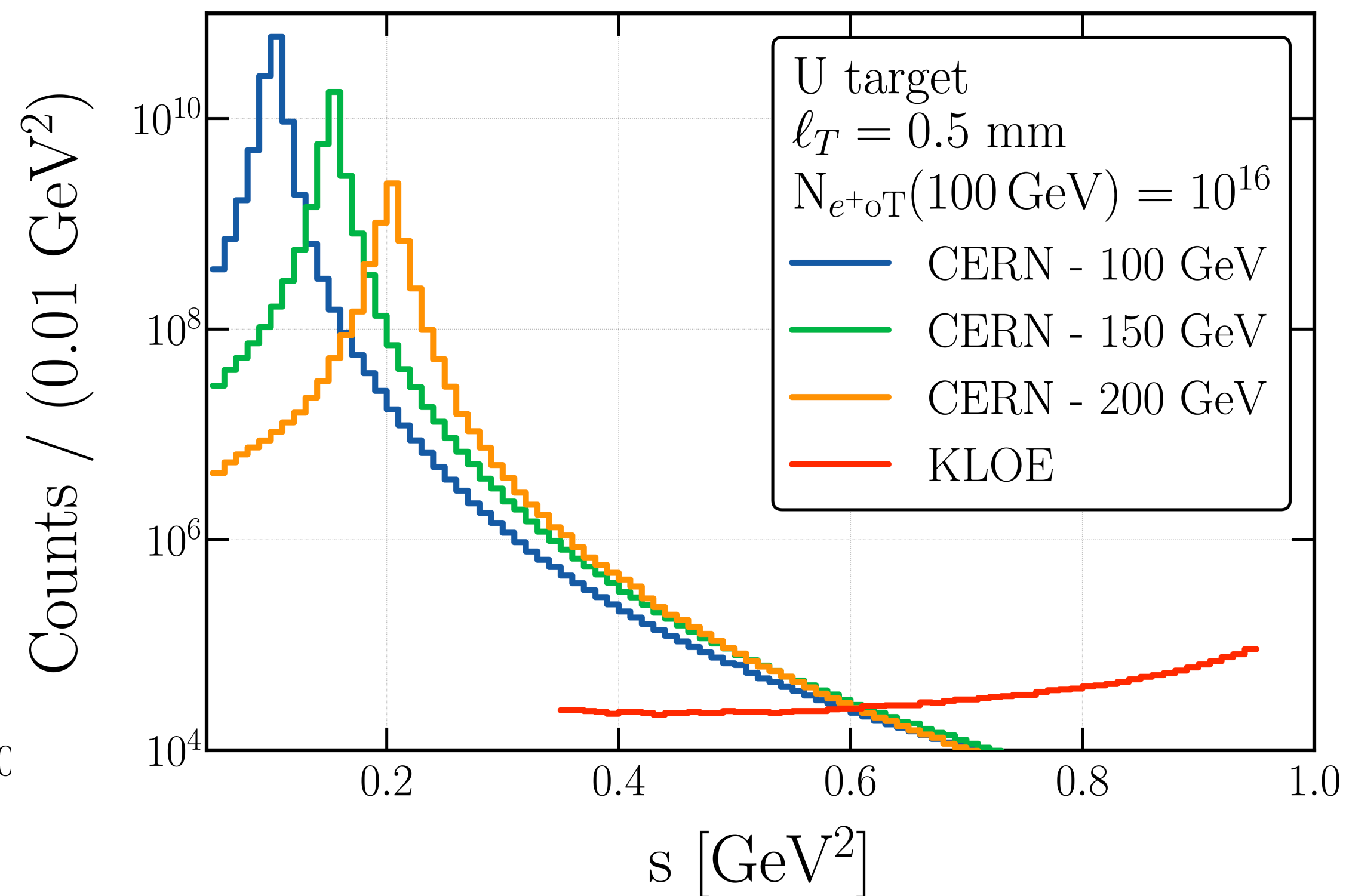
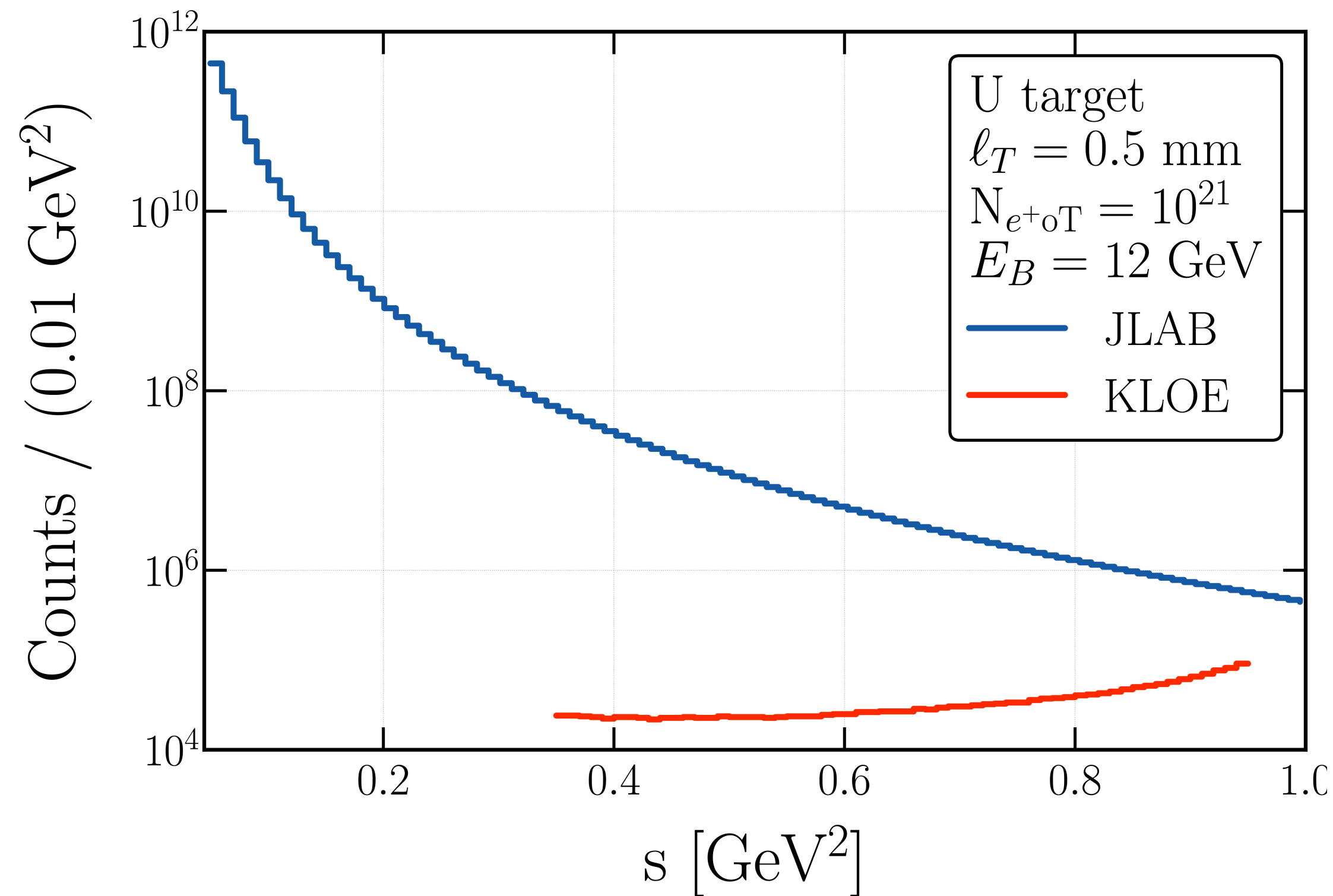

Conclusions

Conclusions

- Prescription on **how to account for non-zero momentum of electrons** in the target taking advantage of **Compton profiles**;
- **Impact** of the atomic electron motion on **the X17 search at PADME** (but not limited to PADME);
- Opens up **new perspectives on positron annihilation on fixed targets**: **increased sensitivity** for BSM theories, **hadronic cross section measurement**, **impact on MUonE...**

Dark pseudo-scalars

[Arias-Aragon, Darmé, G²dC,
Nardi, Veissière, in preparation]

$$\mathcal{L} \supset i m_e g_{ae} a \bar{\psi}_e \gamma_5 \psi_e$$

5 cm tungsten thick target

LNF: 450 MeV, $10^{18} e^+$ oT

JLAB: 12 GeV, $10^{21} e^+$ oT

CERN: 100 GeV, $10^{16} e^+$ oT

