



The INFN and the European Strategy Update

2nd ECFA-INFN Early Career Researcher meeting – LNF 30 September - 1 October 2024

Sandra Malvezzi
Aleandro Nisati
for the INFN-ESPP Steering Group

The Strategy

The cornerstones of a good strategy

- ❑ **Vision** → identification of goals
 - Ambition/realism – prudence/flexibility - sustainability
- ❑ **Process** → clear roadmap
 - short, medium and long- term priorities

European Strategy Particle Physics (ESPP)

- ❑ initiative promoted by the CERN Council
- ❑ develops recommendations for the future of high-energy physics

Through

- **wide consultation** of the scientific community
 - organized collection of contributions
- **coordination** with similar processes in **other countries** *
in order to guarantee/foster the optimal use of resources at a global level

*US-P5 Particle Physics Project Prioritization Panel <https://www.usparticlephysics.org/2023-p5-report/>

The history

Initiative dates back to 2005, today it is in its third *update*

- ❑ 2005 → LHC
- ❑ 2013 → HL-LHC
- ❑ **2020** → preparation for the post LHC : “Europe needs to be in a position to propose an ambitious post-LHC accelerator project at CERN by the time of the next Strategy update.”
- ❑ 22 Marzo 2024 : il Council launched the new update → significant commitment over the next ~2 years

The INFN started its process of internal discussion already in May 2024
with the 'workshop <https://agenda.infn.it/event/39747>



- The initiatives continue within the CSNs, Laboratories and Sections, and **with the involvement of young people** (e.g event on July 3rd and today!)

The context

Why is a **prompt decision on a future collider** at CERN necessary?

- Preserve commitment and competence of the community (particularly of the younger generations)
- Outline the future for CERN, a unique laboratory of excellence in the world
- Maintain the European leadership in high energy physics - competition with China

Other essential elements of the ESPP

- Diversity in scientific program
- Synergies with “nearby” fields: Astroparticles and Nuclear Physics
 - yesterday’s talks from G. Mizzitelli (CSN2) and R.Nania (CSN3)
- Social and environmental impact: Technology Transfer
- Young people's careers, public commitment and engagement

The update process and its timeline

2024: year of preparation, establishments of committees, choice of locations for the various meetings

2025: submission of scientific inputs, Open Symposium, drafting of the strategic document

2026 discussion at Council and Strategy update (in 2027/2028 Council decides...)

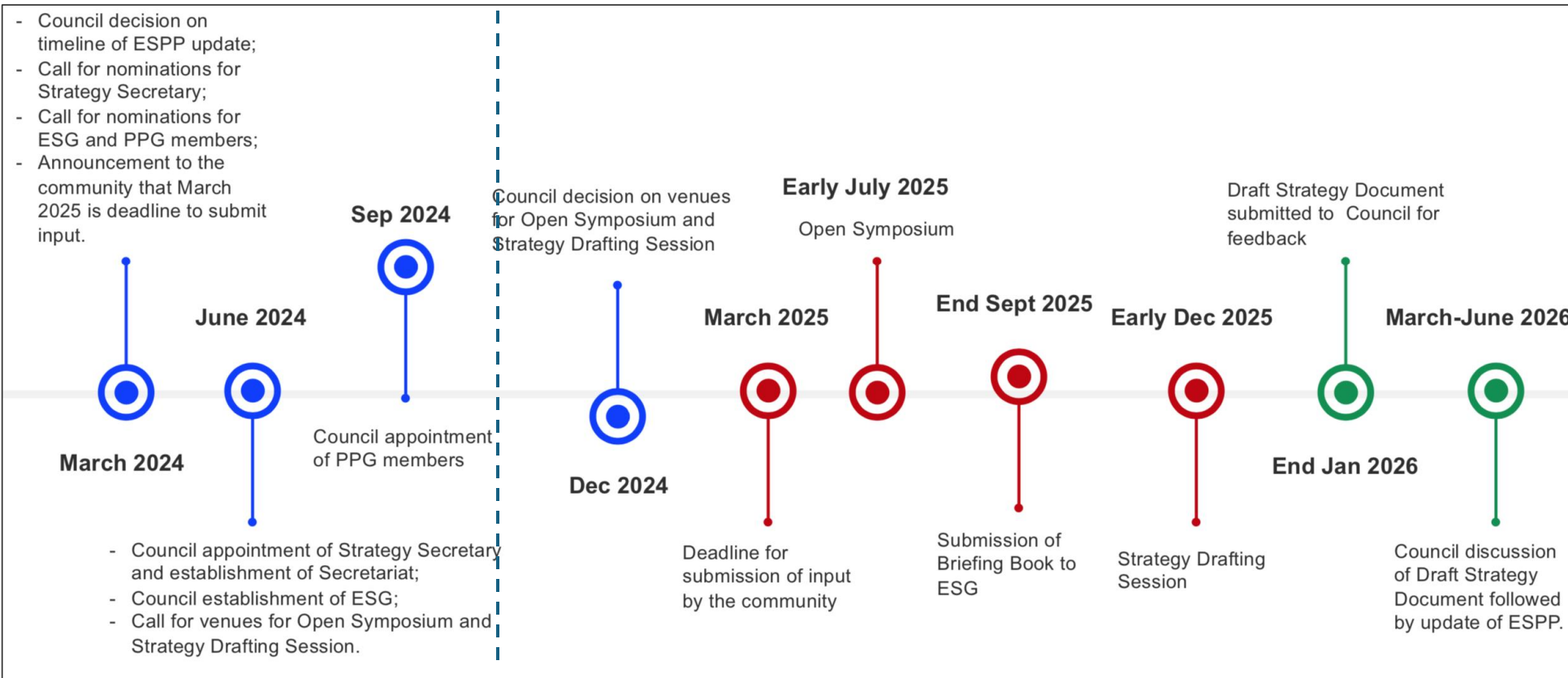

Strategy Secretariat:

organising and running the ESPP process

Strategy Secretary (K. Jakobs.)
Paris Sphicas (ECFA Chair)
Hugh Montgomery (SPC Chair)
Dave Newbold (LDG Chair)

European Strategy

Group (ESG): Prepares the Strategy Document

Physics Preparatory Group

(PPG): collects input from the community, organises the Open Symposium, prepares the Briefing Book

Inputs from the community will be reviewed by **ESG**: careful and rigorous study of the documentation provided, i.e of the Briefing Book drafted by **PPG** with support of the **Strategy Secretariat**

Open Symposium 23-27 June 2025 - Lido di Venezia ! I do hope to see you there

The development of a strategy

Have important questions to pursue

- ❑ What are the future challenges of particle physics?
 - ❑ **Current physics landscape: motivations and future collider projects (P.L. Campana)**
 - ❑ **A theory perspective on future colliders: is it worth it or not? (R. Franceschini)**

Create opportunities to address them

- ❑ Which tools offer the best potential to realize them?
- ❑ What technologies need to be developed and enhanced?
 - ❑ **Accelerator technology for next generation colliders: challenges and opportunities (L. Rossi)**
 - ❑ **The detector challenge (G. Gaudio)**

ESPPU 2020 recommendations

Original version

❑ Fully exploit the **LHC potential** and lay the foundations of a new system of **future accelerators**

❑ feasibility study

❑ conceptual design

❑ infrastructure and costs for a new ring (~100 km) hosted at CERN .

- First stage FCC-ee.

- Second stage FCC-hh (same tunnel)

 - a scheme that CERN has already used with the sequential construction of LEP and LHC.

❑ R&D for New Accelerators

❑ **Muon Collider (MC)**, an innovative muon collider in the design phase characterized by great potential for both precision and discovery physics.

❑ **Plasma acceleration** (EuPraxia)

“An **electron-positron Higgs factory** is the **highest-priority** next collider. For the longer term, the European particle physics community has the **ambition to operate a proton-proton collider at the highest achievable energy.**”

“Europe, together with its international partners, should investigate the **technical and financial feasibility** of a future hadron collider **at CERN** with a centre-of-mass energy of at least 100 TeV and with an **electron-positron Higgs and electroweak factory as a possible first stage.**”

“**Such a feasibility study of the colliders and related infrastructure should be established as a global endeavour and be completed on the timescale of the next Strategy update.**”

“**The European particle physics community must intensify accelerator R&D and sustain it with adequate resources.**”

Flagship project: the integrated FCC

Comprehensive long-term program, follows ESPPU 2020 recommendations, **maximizes** physics opportunities

- Phase 1: FCC-ee (Z, W, H, $t\bar{t}$): Higgs factory, electroweak & top factory
- Phase 2: FCC-hh (~100 TeV): natural continuation @ energy frontier, pp & AA collisions; eh option

highly synergic

- Civil engineering and common technical infrastructure, exploits CERN's existing infrastructure
- It allows for the the start-up of a new machine at CERN within a few years after the end of HL-LHC

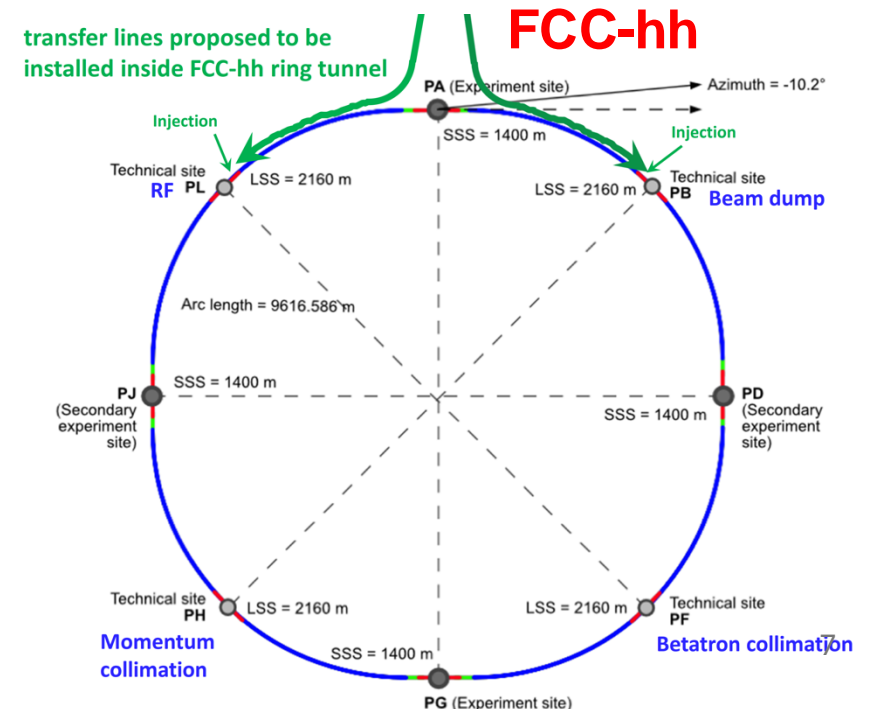
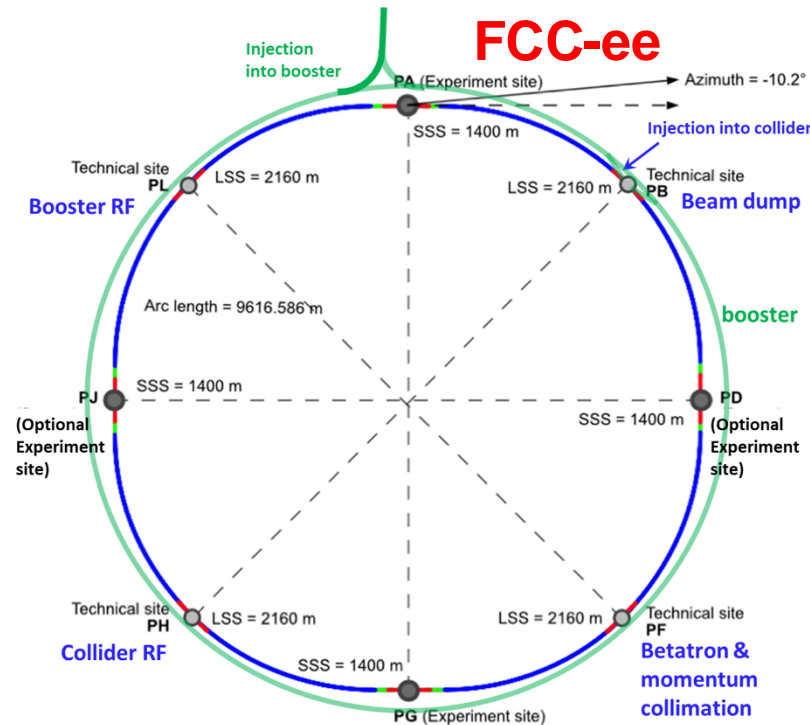
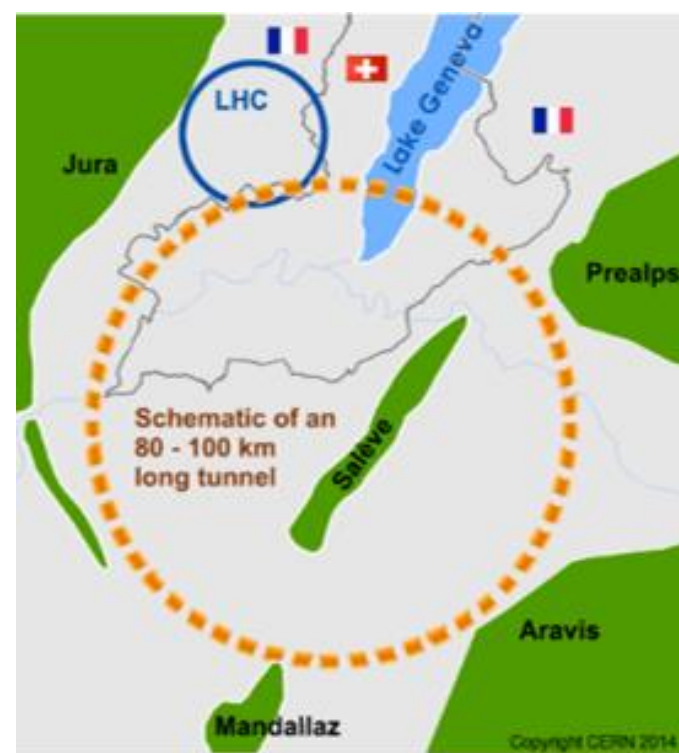

FCC Feasibility Study : Mid-Term Report 2023

Configuration chosen from ~100 initial variants, based on geological and surface constraints (land availability, road access, etc.), environment (protected zones), infrastructure (water, electricity, transport), machine performance, etc.

Principle “avoid-reduce-compensate” (sustainability)

Overall configuration with the lowest risk

- ❑ ring of di 90.7 km
- ❑ 8 surface points

The entire project is now adapted to this configuration

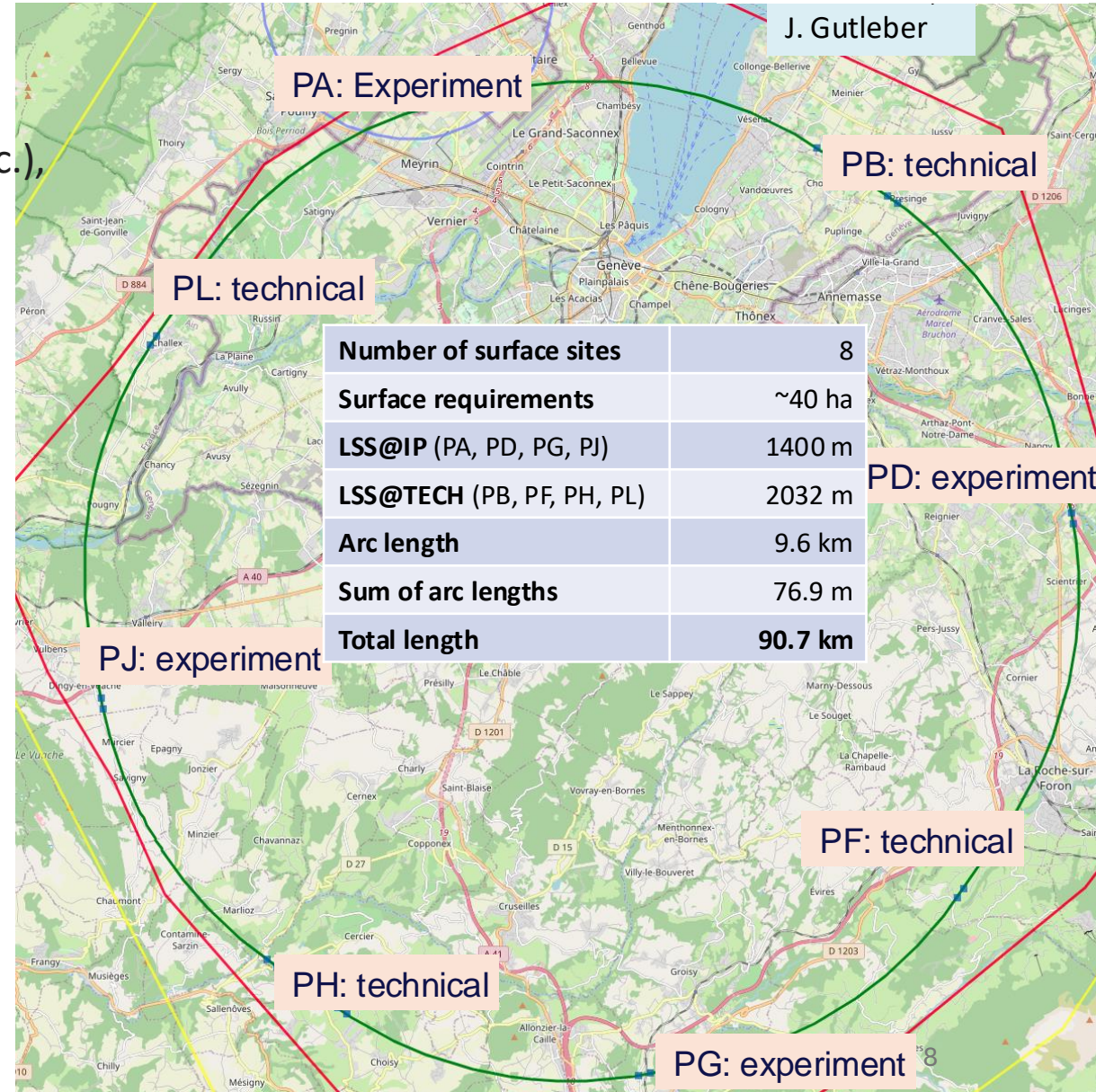

FCC feasibility study mid-term report

Full Report

8 Chapters/Deliverables
~ 700pp document
~ 16 editors
~ 500 contributors

Executive Summary

8 Chapters/Deliverables
~ 45pp document
~ 16 editors



International review committees:

SAC: Scientific Advisory Committee ,
CRP: Cost Review Panel
CERN SPC: Scientific Policy Committee
CERN FC :Financial Committee)

assessed both the level of technical/physical studies and the cost estimate as adequate for this intermediate phase of the project.

further investigation and work towards the final report of the FCC Feasibility Study Group
March 2025

FCC timeline

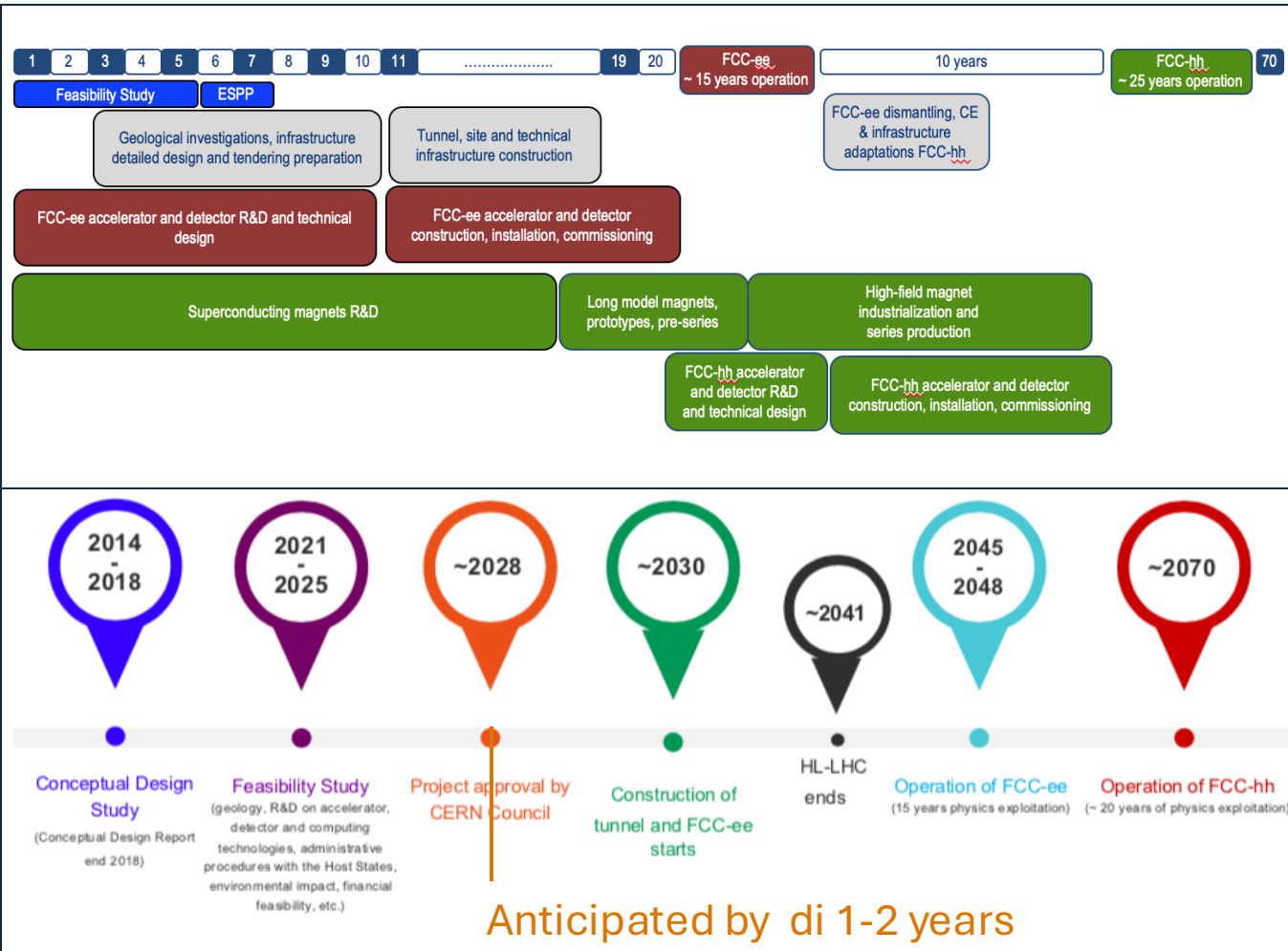

Technical program:

FCC-ee could begin physics operations in **2040** or earlier

More realistic program

- Machine building experience @CERN
- Approval sequence : ESPP, Council
- HL-LHC Program ~ 2041

Future Collider @CERN ~2045

construction in parallel with HL-LHC operations

1st phase collider, FCC-ee: electron-positron @ 90-360 GeV
Construction 2033-2045 → Physics: 2048-2063

2nd phase collider, FCC-hh: proton-proton @ ~ 100 TeV
Construction: 2058-2070 → Physics ~ 2070-2095

To be discussed in the Strategy in relation to technology developments and financing models

INFN: activities & R&D

The FCC project poses many technological challenges including:

- The damping ring and the injectors
- Radiofrequency cavities
- Beam dipoles and quadrupoles
- Machine/detector interface

INFN has promoted/financed **specific R&D** projects that can significantly contribute to the current European Strategy and the one in preparation.

Among these projects there is also the **Muon Collider**.

Muon Collider

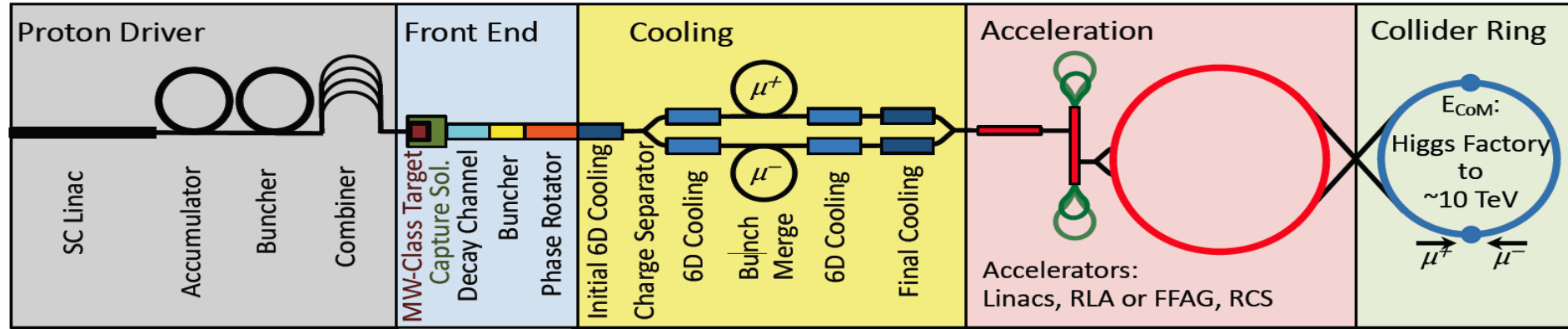

Highly innovative project

- **It combines precision and discovery potential**
- high energy collisions with modest losses of synchrotron radiation (small rings)

Double challenge:

- Muon is unstable ($\tau=2.2 \mu\text{s}$)
- When hadronically produced, it must be «cooled»
- Cooling, acceleration and collisions must be accomplished in a fraction of a second

US P5: The Muon Shot – The US ambition

Particle Physics Project Prioritisation Panel (P5) endorses muon collider R&D: "This is our muon shot"

Recommend joining the IMCC

Consider FNAL as a host candidate

US is already participating to the collaboration

□ INFN community involved in the study of SRF cavities, high field magnets for the cooling cell, and in the study of the interaction region and the detector

□ It is essential to carry out an R&D experiment that demonstrates the feasibility of a high-energy muon collider
 → Demonstrator

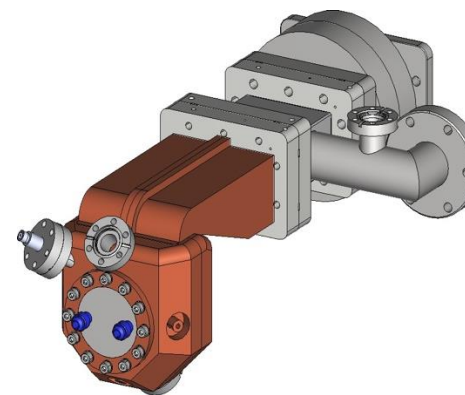

PNRR

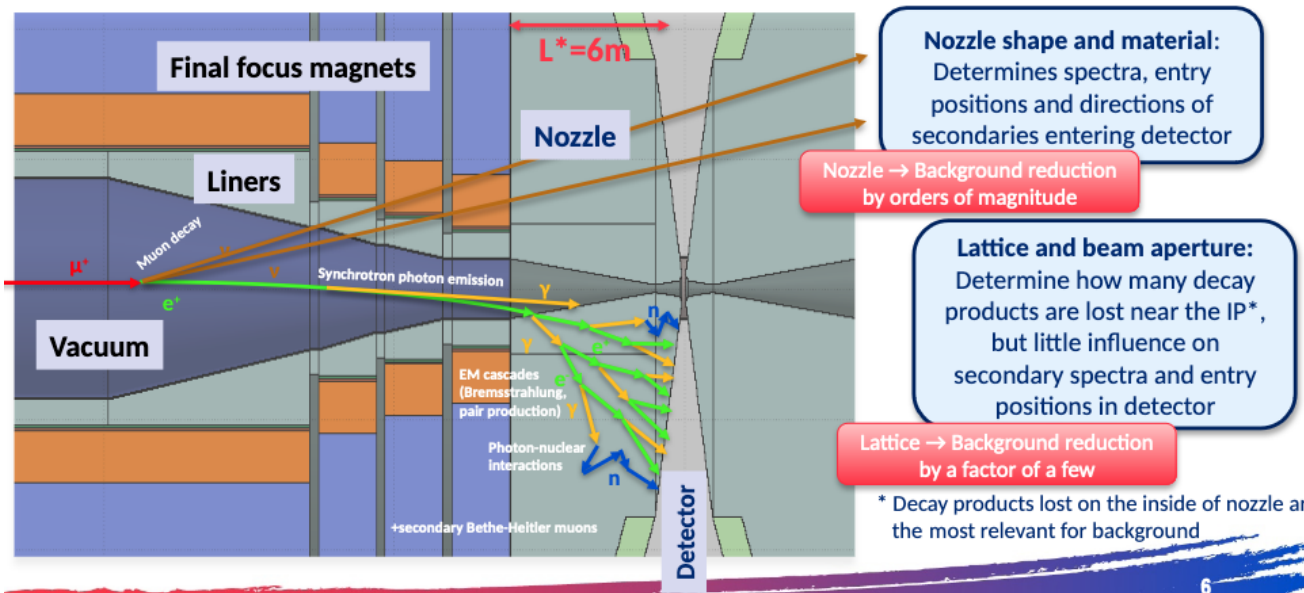
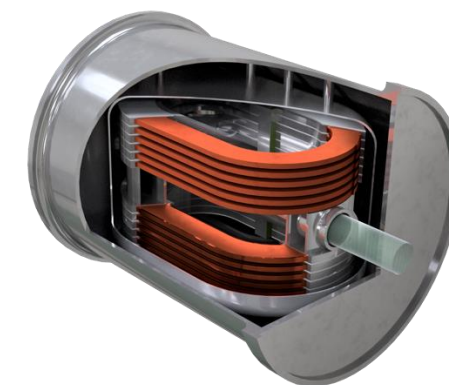

Progetti per Acceleratori di Particelle per prossima European Strategy

International Muon Collider Collaboration

Muon Collider R&D activities

INFN Istituto Nazionale di Fisica Nucleare

LASA-MI

ESPP: WP2 IONIZATION COOLING - DESIGN AND STUDY OF A COOLING CELL

Review dei progetti di acceleratori LASA - 21 Marzo 2024

Interaction Region (MDI and IR)

FCC-ee Interaction Region

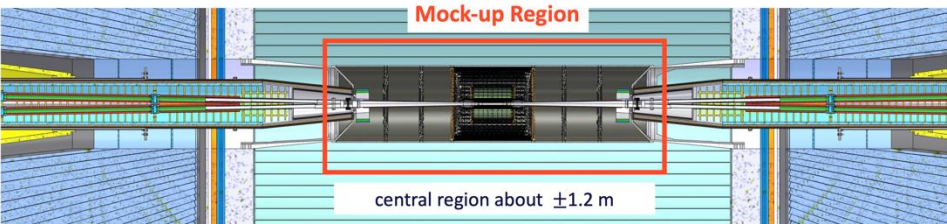

Mock-up Region

central region about ± 1.2 m

IR based on the crab-waist scheme, compact and crowded with tight constraints and many technical challenges → mockup needed for R&D and prove state-of-the-art technological solutions and test its feasibility

It will be built in Frascati in joint venture CERN-INFN.
Addendum KES815/ATS signed by INFN 26.01.2024

Relevant dates from Addendum:

Starting date	1.11.2023
Delivery to INFN-LNF of the central vacuum chamber	30.11.2024
End date	31.12.2025

Agreements with CERN for building a **mock-up** in LNF → in-situ checks

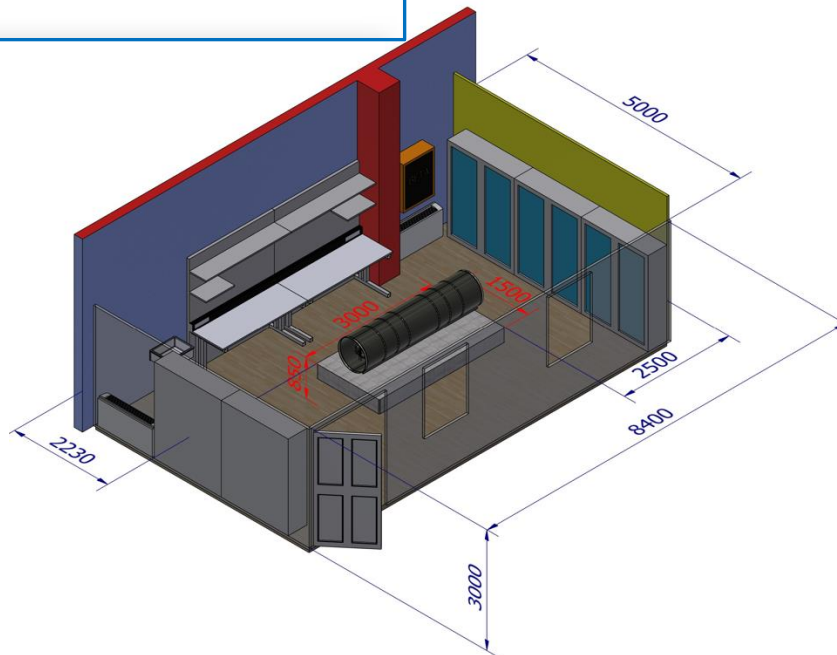

LNF

Damping Ring for FCC-ee

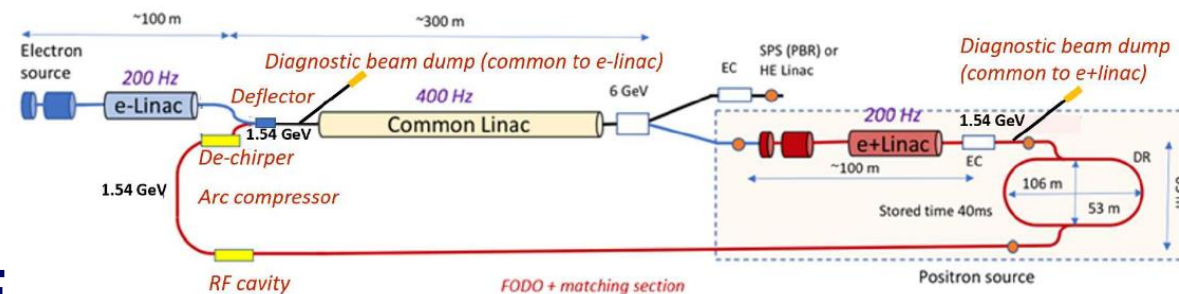

- ❑ Necessary to "compress" the positron beam originating from the source until it reaches the characteristics necessary to carry out high-frequency collisions with the electron beam in the FCC-ee ring
- ❑ Project supported by INFN and CERN

Superconducting radio frequency cavities

Niobio (Nb) SRF cavities
INFN-LASA Milano

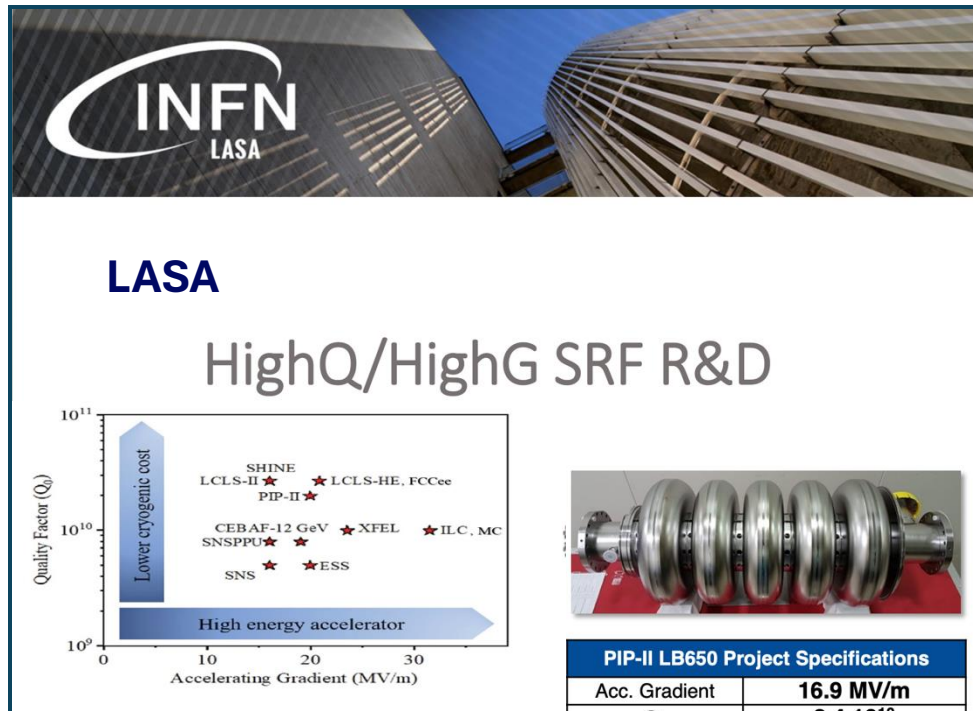

- R&D activity at LASA aimed at the production of ultra-high Q cavities for PIP-II
- experience to learn from

Nb_3Sn on Cu coatings
INFN-LNL Legnaro

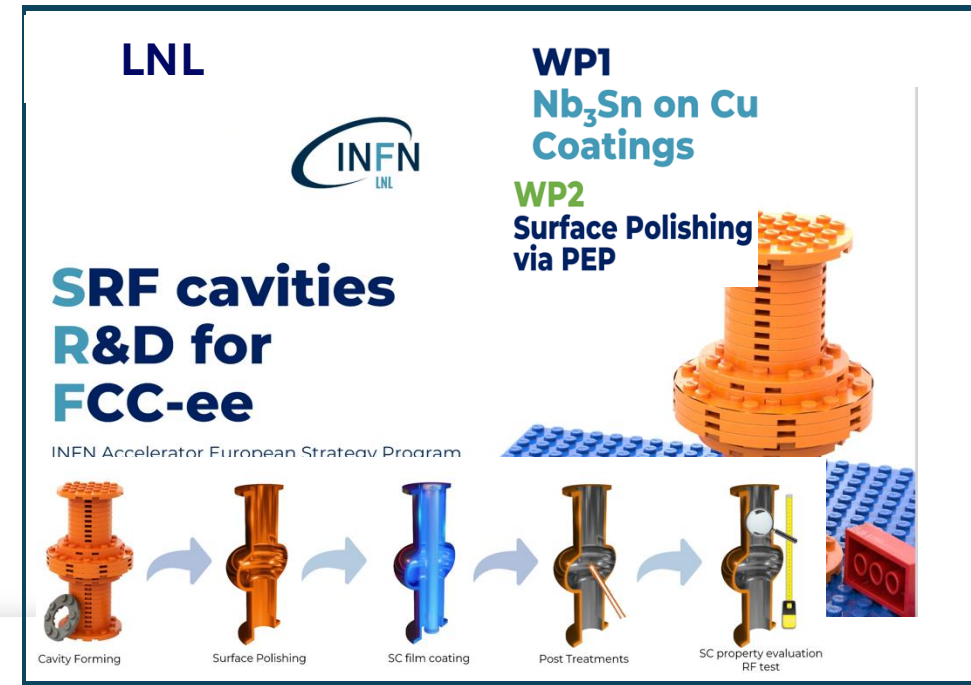

This solution can be used at higher temperatures than Niobium (4.5 K vs 2.0 K), with consequent important savings on the energy spent by the cryogenic system

High Field Magnets



The development of high-field superconducting magnets is crucial for future hadron colliders, at energies well above those of the LHC

- ❑ INFN strongly committed to this study with the research program FALCON-D (Future Accelerator post-LHC Cos-theta Optimized Nb₃Sn Dipole.)
 - ❑ INFN/CERN agreements
 - ❑ Feasibility demonstration of 12 T field dipoles is close
 - ❑ 14-16 T dipoles need further R&D
 - ❑ INFN & CERN support this study also aimed at the realization of a double aperture dipole

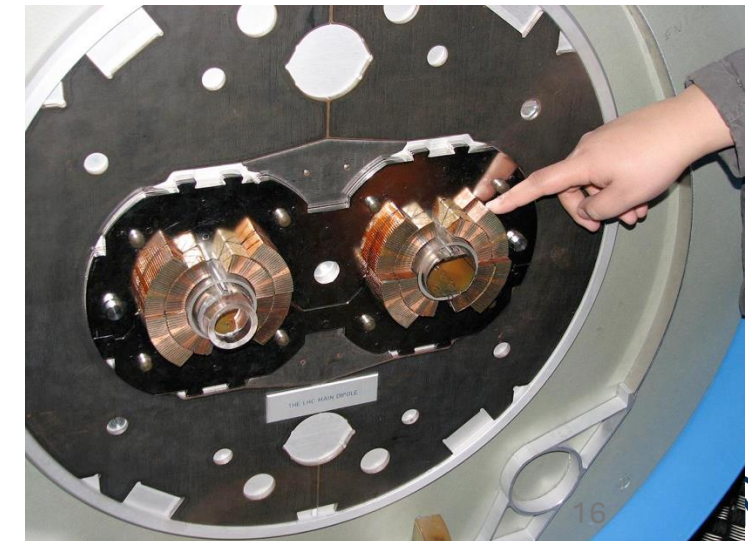
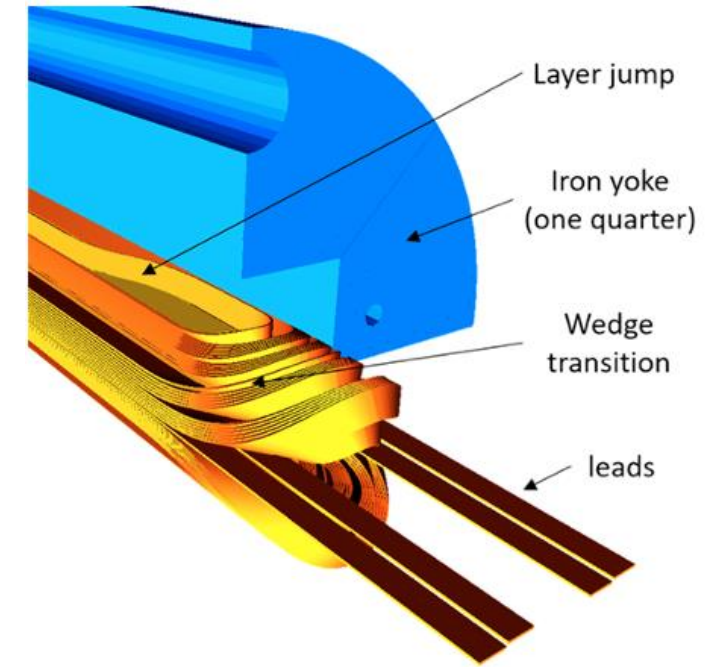

Technological challenge: high field magnets operating at “high” temperatures (HTS)

Detectors : ECFA detector roadmap

Strategic recommendations:

- ❑ R&D facilities
 - Test beam, large-scale prototyping, irradiation
- ❑ Engineering support for detector R&D
- ❑ Development of specific software for instrumentation
- ❑ International coordination and organization of R&D activities:

❑ DRD collaborations

- long-term strategic financing program
- blue-sky R&D

ESPPU 2020 : *The success of particle physics experiments relies on innovative instrumentation and state-of-the-art infrastructures. To prepare and realise future experimental research programmes, the community must maintain a strong focus on instrumentation. Detector R&D programmes and associated infrastructures should be supported at CERN, national institutes, laboratories and universities. ...*

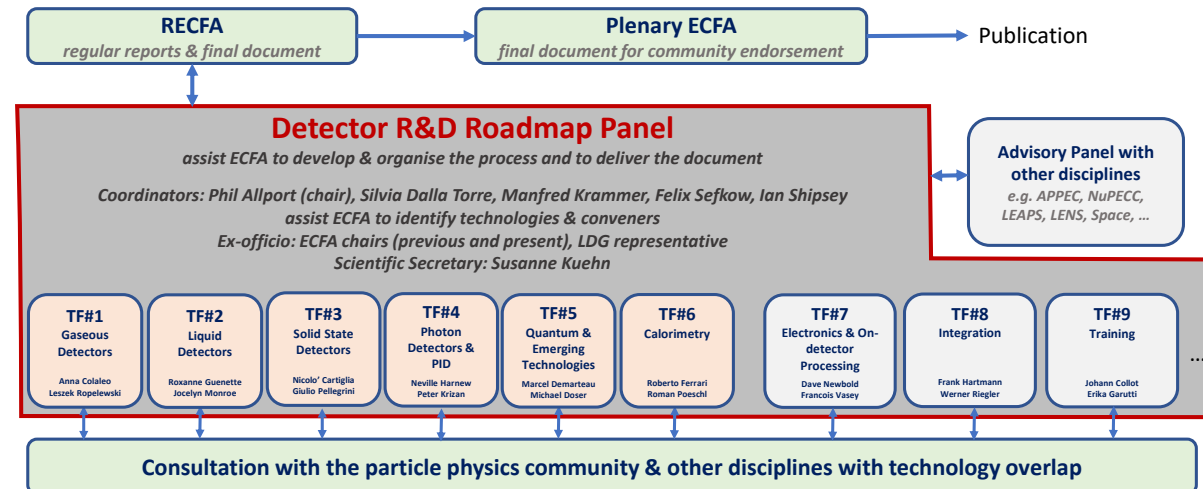

Attract, cultivate and support the careers of young R&D experts

Collaborazioni DRD

Fully Approved for an initial period of 3 years by CERN Research Board in December 2023



- Gaseous Detectors (DRD1) [ex RD51]
- Liquid Detectors (DRD2)
- Photodetectors & Particle ID (DRD4)
- Calorimetry (DRD6)

Reports at open session of DRDC meeting:
<https://indico.cern.ch/event/1356910>
Full Proposals in CERN CDS

Conditionally approved



- Semiconductor Detectors (DRD3) [ex RD50, RD42,..]

Both aim for approval in June

Full proposals recently submitted for review



- Quantum Sensors (DRD5)
- Electronics (DRD7)

Letter of Intent submitted



- Integration (DRD8)

Full Proposal to be written by the end of this year

- Italian INFN colleagues in various roles of responsibility
- Waiting for MoU and Annex
- INFN financing scheme discussed with the Presidents of CSN, to be finalized
- Inter CSN review process

Software & Computing

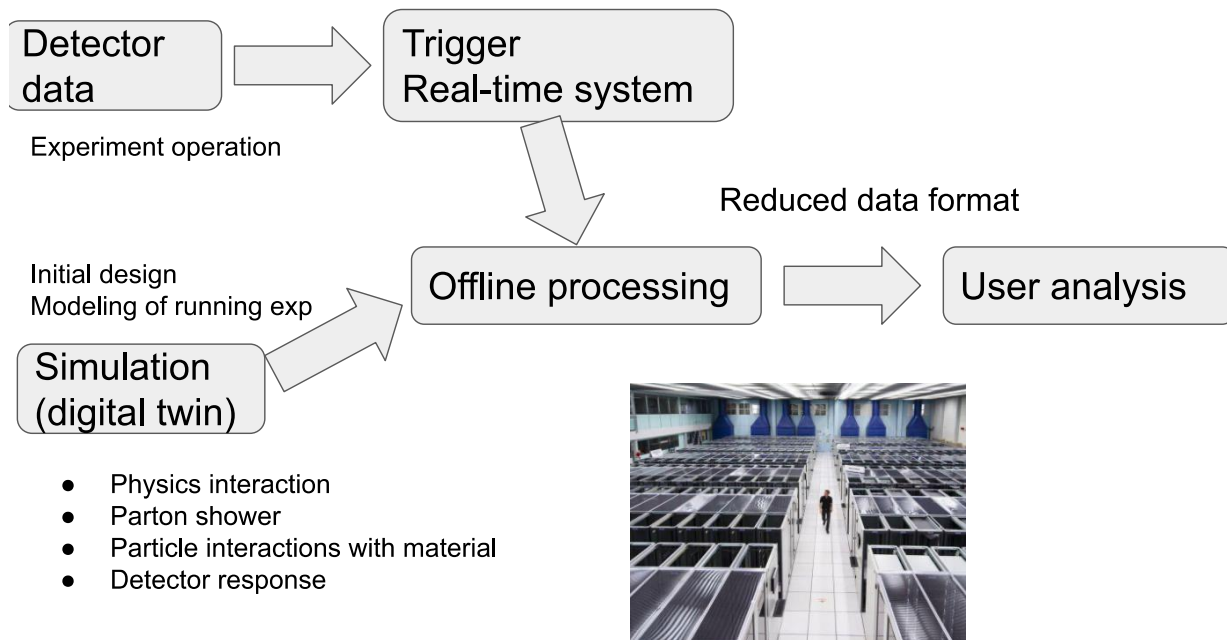

Community is Growing

challenge/opportunity:
detector optimization with
artificial intelligence?



Machine-learning Optimized
Design of Experiments



an European Initiative for advancing the use of Artificial Intelligence (AI) In Fundamental Physics. Members are working on particle physics, astropar
ysics, gravitational wave physics, cosmology, theoretical physics as well as simulation and computational infrastructure.

Role of AI: accelerator control, data acquisition, event triggering, anomaly detection, new physics scouting, event reconstruction, event generation, detector simulation, LHC grid control, analytics, signal extraction, likelihood free inference, background rejection, new physics searches, etc..

....Quantum Computing

Towards a decision ...

The choice of the next collider is rather complicated (multi parametric model!)

□ Many countries

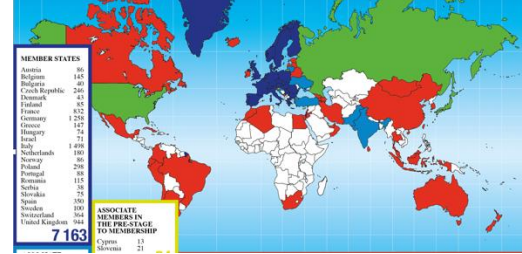

CERN today:

- 24 Member States
- 8 Associate States
- 2 associated → members
- 4 States /organization as observers

Il futuro non è più quello di una volta



www.psicologa-zodena.com

□ Wide community



~ 17'000 CERN users

+ 2600 CERN staff members

□ Financing



- Accurate cost estimate required for Final FS report
- CERN budget
- Extra CERN

... alternative scenarios ?

By Karl Jakobs (Strategy Secretary)

4-5 July 2024 - ECFA

meeting@LNF)

In this Strategy Update process, we must converge on a preferred option for the next collider at CERN plus alternative options (prioritised)

- Current baseline – justified by 2020 Strategy: FCC integrated programme (FCC-ee followed by a hadron collider of at least 100 TeV)
- Possible alternative scenarios (for next collider, following the HL-LHC):
 - Realisation of a lower-energy hadron collider (50 – 80 TeV) on an earlier timescale (2050 – 2055)
 - Linear Collider at CERN (CLIC, ...)
 - Muon Collider at CERN
 - Further exploitation of the LHC physics programme, eventually with the addition of e-h collisions

or...
- Non-exhaustive list, other scenarios may come up and be proposed by the community

Future Accelerator options

ESPP 2020 recommendation

Alternative options

Possible alternative options if CepC approved in 2025?

e^+e^- collider

hadron collider

electron-hadron collider

$\mu^+\mu^-$ collider

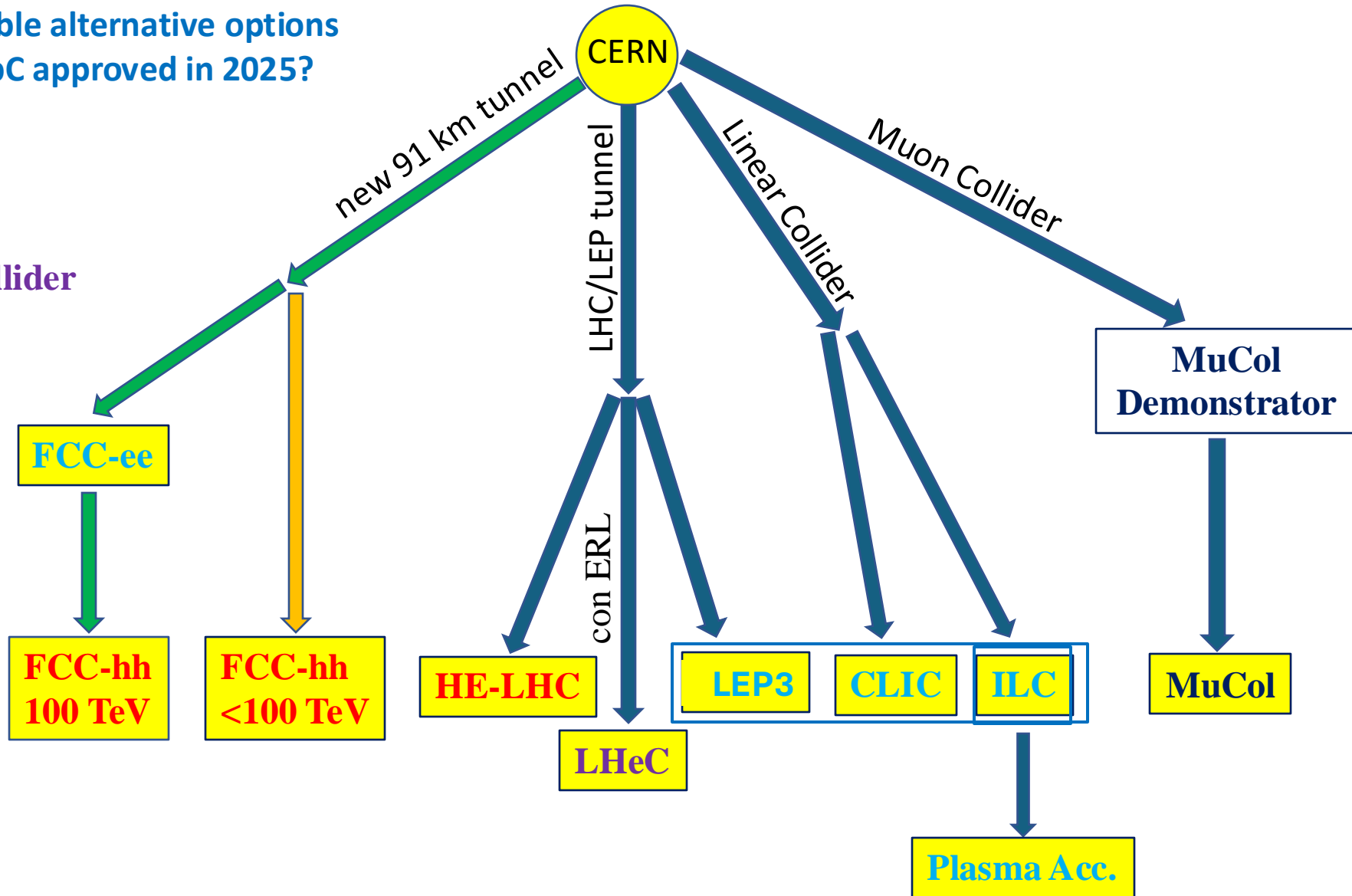

Streamlining the process and form of national inputs (I)

Paris Sphicas (ECFA chair)

3. Questions to be considered by individual countries/regions in forming and furnishing a “national input” to the ESPP:
 - a. Which is the preferred next major/flagship collider project for CERN ?
 - b. What are the most important elements in the response to (3a)?
 - Physics potential**
 - Long-term perspective**
 - Financial and human resource requirements – and implications for other projects**
 - Timing**
 - Careers and training**
 - Sustainability**

Streamlining the process and form of national input (II)



- c. How does the answer to (3a) get affected, i.e. should CERN/Europe proceed with the preferred option or should alternative options be considered:
 - i. if Japan proceeds with the ILC in a timely way?
 - ii. if China proceeds with the CEPC on the announced timescale?
 - iii. if the US proceeds with a muon collider?
 - iv. if there are major new (unexpected) results from the HL-LHC or other HEP experiments?
 - v. Beyond the preferred option, what topics for concurrent R&D on accelerators (e.g., High-Field Magnets, RF technology, alternate accelerators/colliders...) should be prioritised?
- d. What is the prioritized list of alternative options if the preferred one is not feasible (due to cost, timing, international developments, or other reasons)?
- e. What are the most important elements in the response to (3d)?
- f. To what extent should CERN participate in Nuclear, Astroparticle or other areas of science, while keeping in mind and adhering to the CERN convention? Please use the current level and form of activity as the baseline for comparisons.

CERN Convention

The rational of the “exercise”

Karl’s reminder:

Current baseline – justified by 2020 Strategy: FCC integrated programme (FCC-ee followed by a hadron collider of at least 100 TeV)

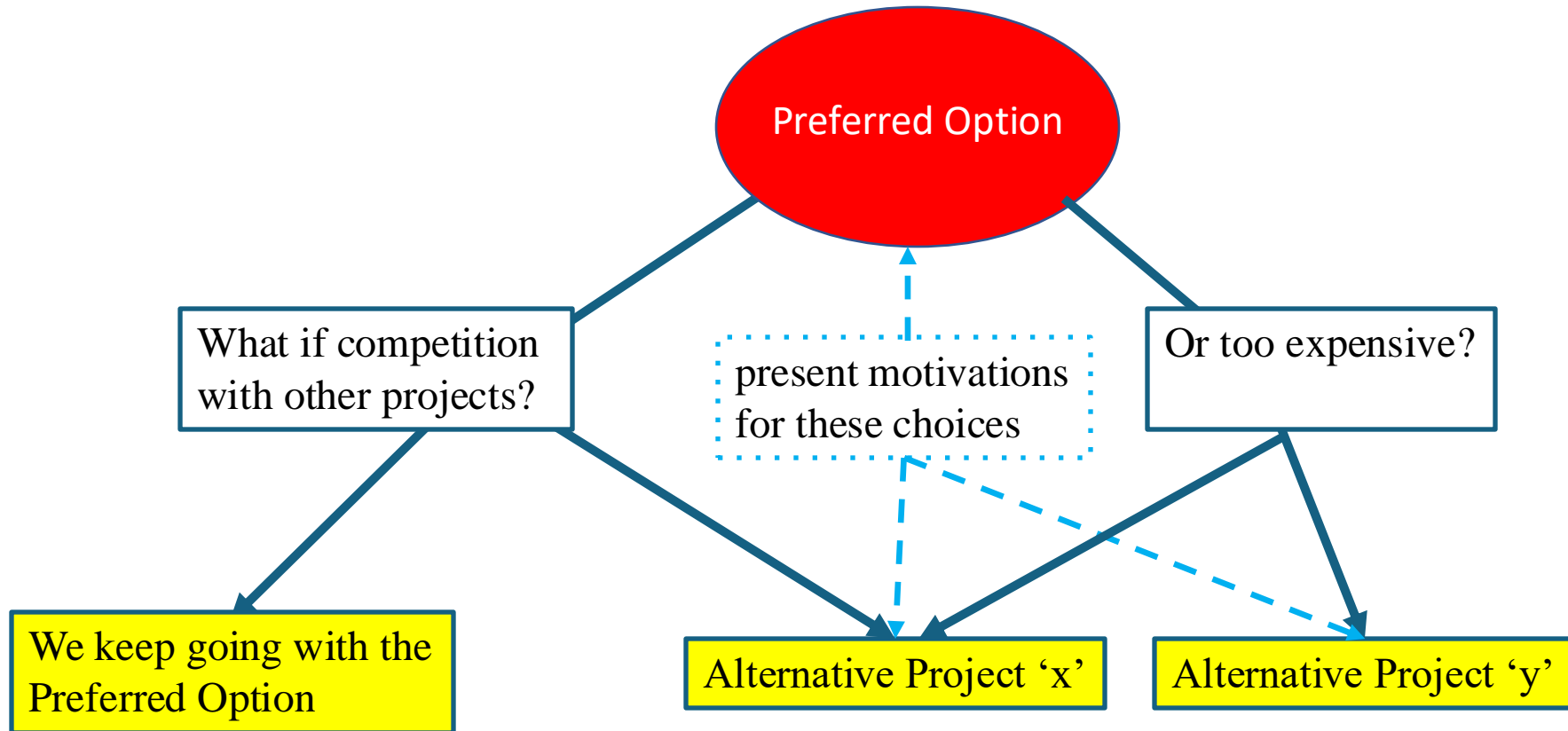

INFN Input for the European Strategy

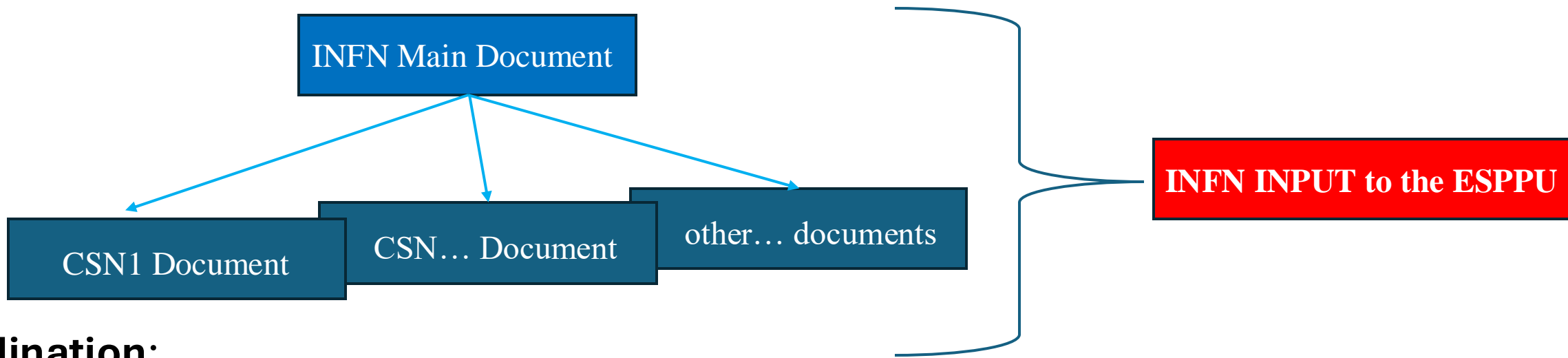

- **Coordination:**

- **Steering Group** (C. Borca, M. Ciuchini, S. Malvezzi, A. Nisati, R. Tenchini)
- **Working group (GdL) :**
 - Chairs of the 5 Scientific Committees
 - Directors of National Laboratories
 - Chair of the INFN Machine Advisory Committee
 - Chair of the INFN National Computing Committee
 - Representatives of the INFN communication office

ECRs (your!) contribution

- ❑ It is important that the community of young researchers participates actively and contributes to the Strategy process.
- ❑ Interaction of young researchers from the various INFN/University locations (network)
- ❑ Interaction of ECR (Early Career Researchers) with INFN
- ❑ Interaction of ECR with ECFA (i.e., the international community)
- ❑ ECRs' remarks and vision are relevant to build the future of scientific research in the HEP field
- ❑ The most significant points emerging from the debate within the ECR community should become an integral part of the input for the next

INFN Strategy events

- 6-7 Maggio kick-off meeting a Roma
 - 3 Luglio : first meeting comunità ECR a LNF
 - 30 Settembre -1 Ottobre 2024: 2° meeting comunità ECR <https://agenda.infn.it/event/42691/>
 - 1 Ottobre 2024: Incontro della comunità dei fisici teorici (e sperimentali)
<https://agenda.infn.it/event/42594/timetable/>
 - 4 Febbraio 2025 : Workshop INFN: finalizzazione Input alla European Strategy – Milano Bicocca
 - Vari meeting del GdL (il prossimo e' il 3 dicembre)
-
- [Prossimo Plenary ECFA](#) 14-15 Nov 2024 (al CERN)
 - [Meetings ICFA](#)
 - [Town Symposium in Italy!](#)