

# LE SORGENTI NATURALI DI RADIAZIONI IONIZZANTI

Com'è noto, la radioattività è una normale componente dell'ambiente naturale. L'uomo è stato costantemente esposto alle radiazioni di origine naturale fin dal suo apparire sulla terra e queste sono rimaste l'unica fonte di irradiazione fino a poco meno di un secolo fa. Ancora adesso, malgrado il largo impiego di sostanze radioattive artificiali e di impianti radiogeni di vario genere, la radioattività naturale continua a fornire il maggior contributo alla dose ricevuta dalla popolazione mondiale ed è assai improbabile che ciò non continui a verificarsi anche in futuro.

Nella radioattività naturale si distinguono:

Componente  
terrestre:



radionuclidi cosiddetti primordiali presenti in varie quantità nei materiali inorganici della crosta terrestre (rocce, minerali) fin dalla sua formazione.

Componente  
extra-terrestre



- raggi cosmici
- radionuclidi cosmogenici.

**Quando ci si riferisce a tutte queste sorgenti si parla di  
fondo naturale di radiazioni.**

# RAGGI COSMICI

I raggi cosmici provengono, per la maggior parte, dal profondo spazio interstellare e sono costituiti principalmente da **particelle cariche positivamente: protoni (85%), alfa (14%) e nuclei pesanti, con energie di parecchi MeV**, che quando giungono in prossimità della terra, risentono dell'azione derivante dal campo magnetico terrestre.

I flussi sono modulati dal vento solare e dai campi magnetici interplanetari.

C'è anche una componente solare che trae origine dalle esplosioni nucleari sul sole e consiste ancora di protoni e particelle cariche positive.

I raggi cosmici sono in gran parte intrappolati nel campo magnetico terrestre in due zone:

- **prima: a circa 1 RAGGIO terrestre dalla superficie, è popolata principalmente da protoni con energie di qualche centinaio di MeV;**
- **seconda: più esterna a 4 RAGGI terrestri, è popolata principalmente da elettroni con energia media di circa 7 MeV.**

# RAGGI COSMICI

L'interazione di queste particelle di alta energia – raggi cosmici primari – con l'atmosfera terrestre comporta l'emissione di numerosi prodotti secondari, quali ad esempio mesoni (particelle di massa compresa tra l'elettrone ed il protone), elettroni, fotoni, protoni e neutroni che a loro volta possono creare altre particelle secondarie.

**Per la maggior parte i raggi cosmici primari vengono assorbiti nello strato più alto dell'atmosfera e sulla terra i raggi cosmici secondari.**

**Quindi, parte della radiazione cosmica giunge sino a terra, generando nell'interazione con l'atmosfera cascate elettro – fotoniche.**

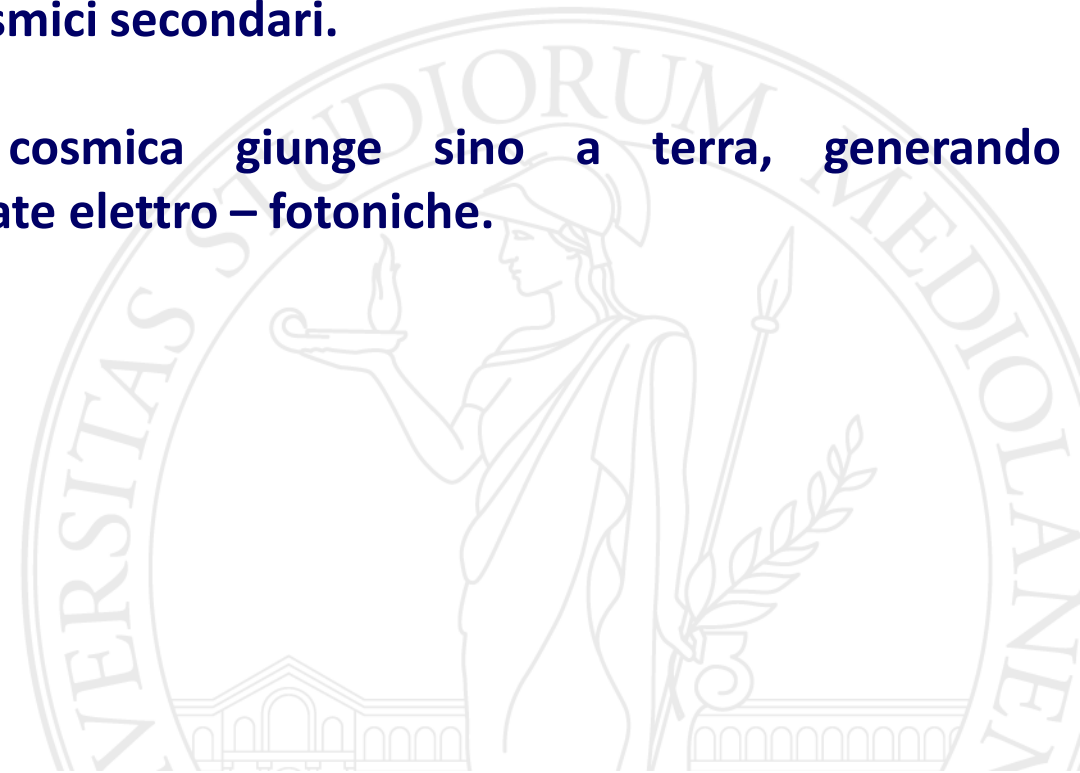

# RAGGI COSMICI

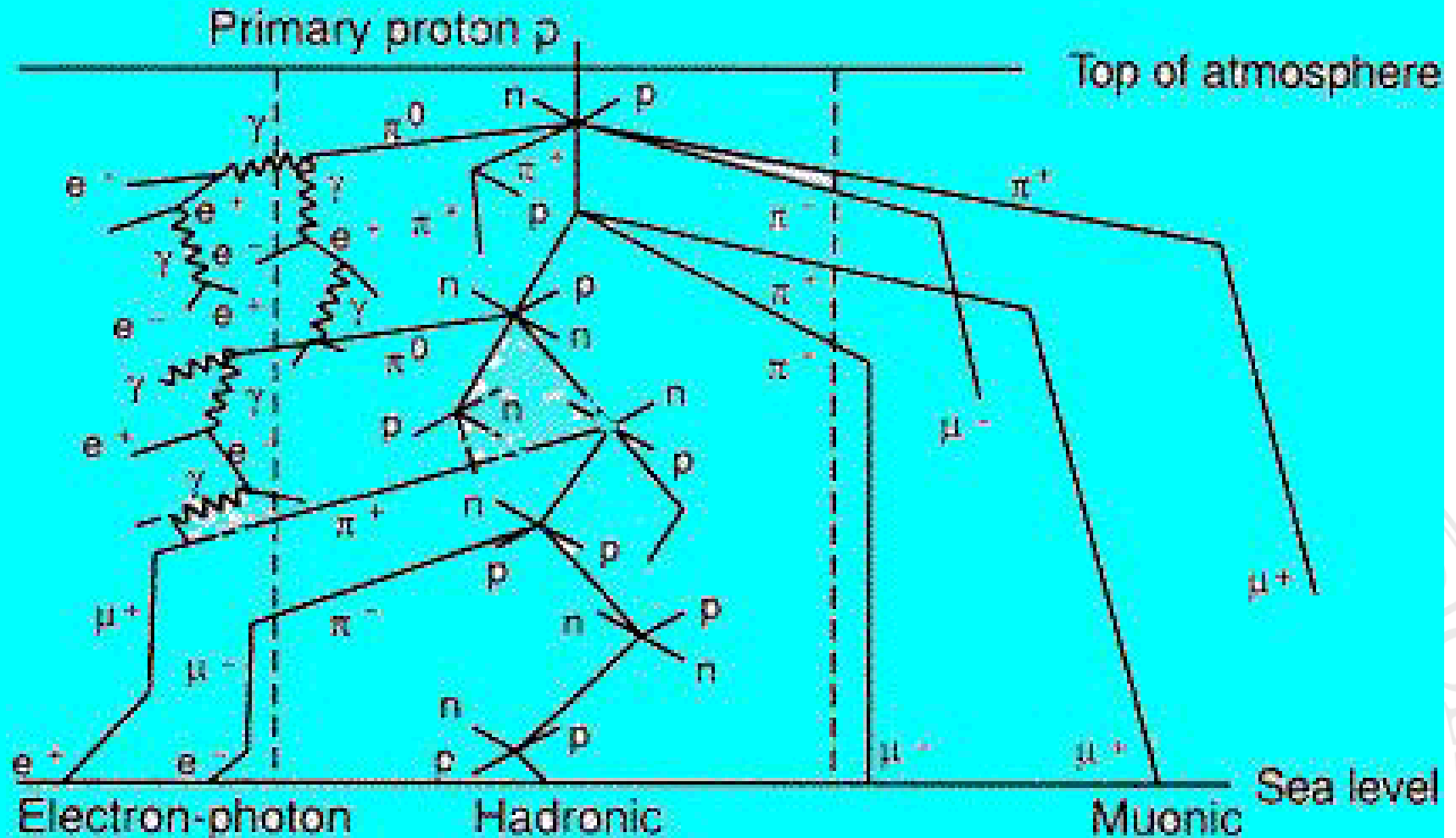

**Rappresentazione schematica della produzione di particelle in atmosfera**

# RAGGI COSMICI

Ai poli il contributo di dose dovuto ai raggi cosmici è maggiore rispetto alle zone equatoriali, per effetto dell'azione del campo magnetico terrestre.

Il livello di dose dovuta ai raggi cosmici livello di dose aumenta con l'altitudine, con il ridursi dello spessore d'aria che fa da schermo:

- a livello del mare è di circa  $0.4 \text{ mSv a}^{-1}$ ; raddoppia ogni circa 1500 metri;
- a 10 km di altitudine, l'esposizione alla radiazione cosmica è quasi 100 volte più elevata di quella a livello del mare.

L'atmosfera produce infatti al livello del mare una protezione equivalente a quella di uno schermo di calcestruzzo di circa 4 m di spessore, mentre alla quota di 10000 m l'effetto di schermaggio si riduce a circa 1 m.

**L'esposizione alla radiazione cosmica è di notevole interesse per gli equipaggi degli aerei destinati ai voli intercontinentali.**

**Per i piloti e assistenti di volo questi livelli, dell'ordine di  $5 \text{ mSv h}^{-1}$  costituiscono un problema reale, soprattutto se effettuano voli con rotte polari.**

# RAGGI COSMICI

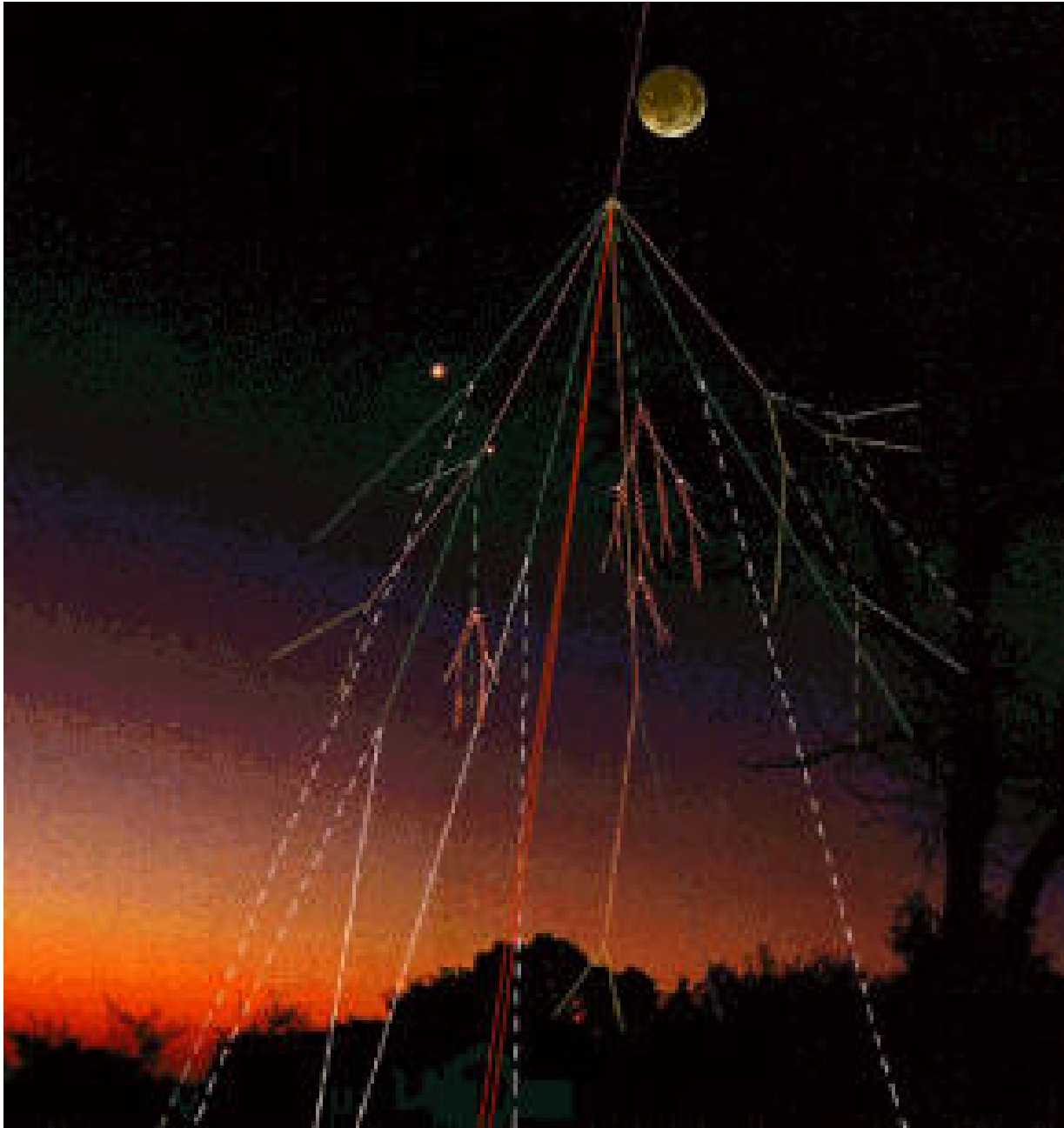

livello di dose aumenta con l'altitudine, con il ridursi dello spessore d'aria che fa da schermo:

a livello del mare **è di circa 0.4 mSv a<sup>-1</sup>; raddoppia ogni circa 1500 metri.**

# RAGGI COSMICI

Figure IV. Components of the dose equivalent rate due to cosmic rays in the atmosphere [U3]

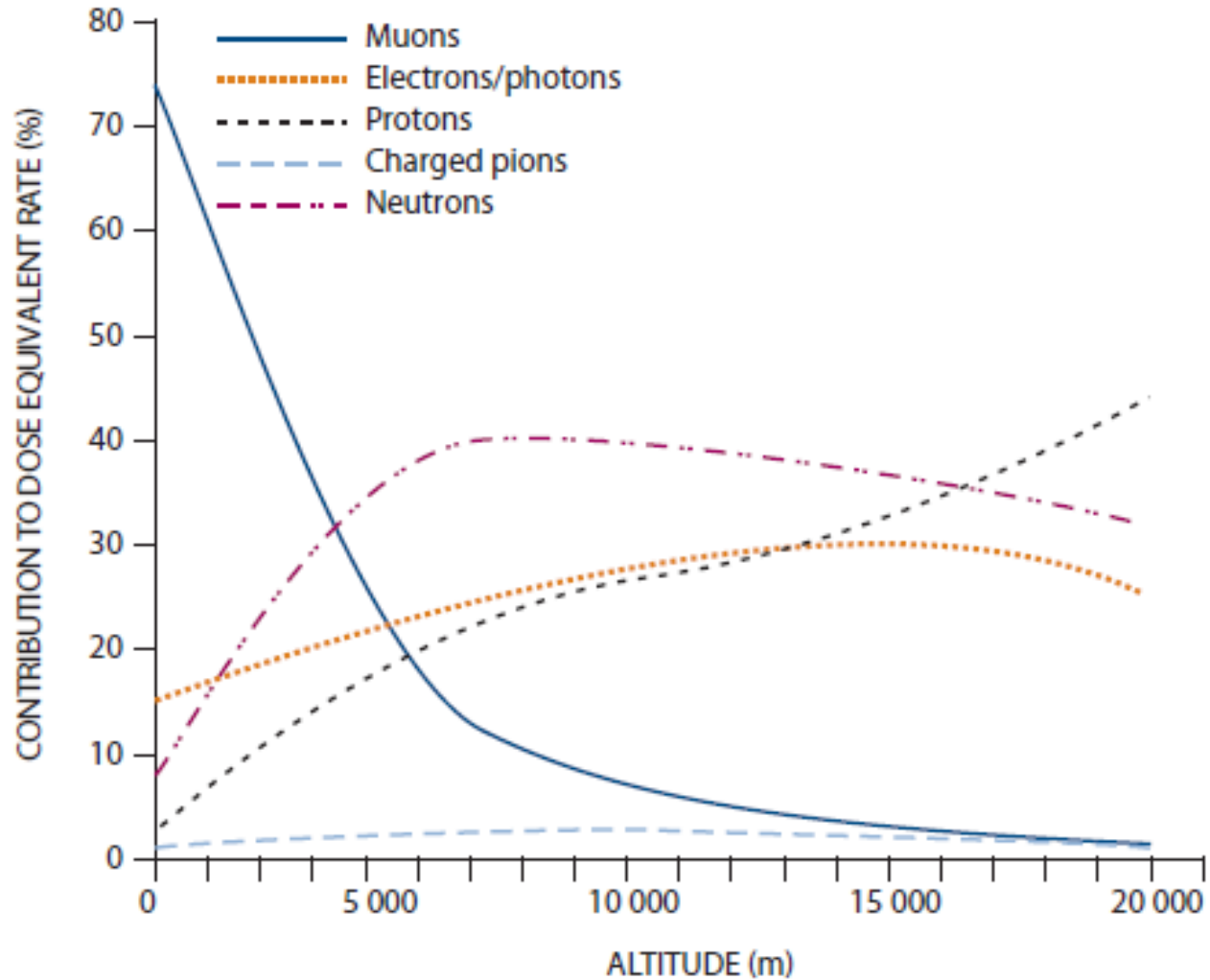

# RAGGI COSMICI

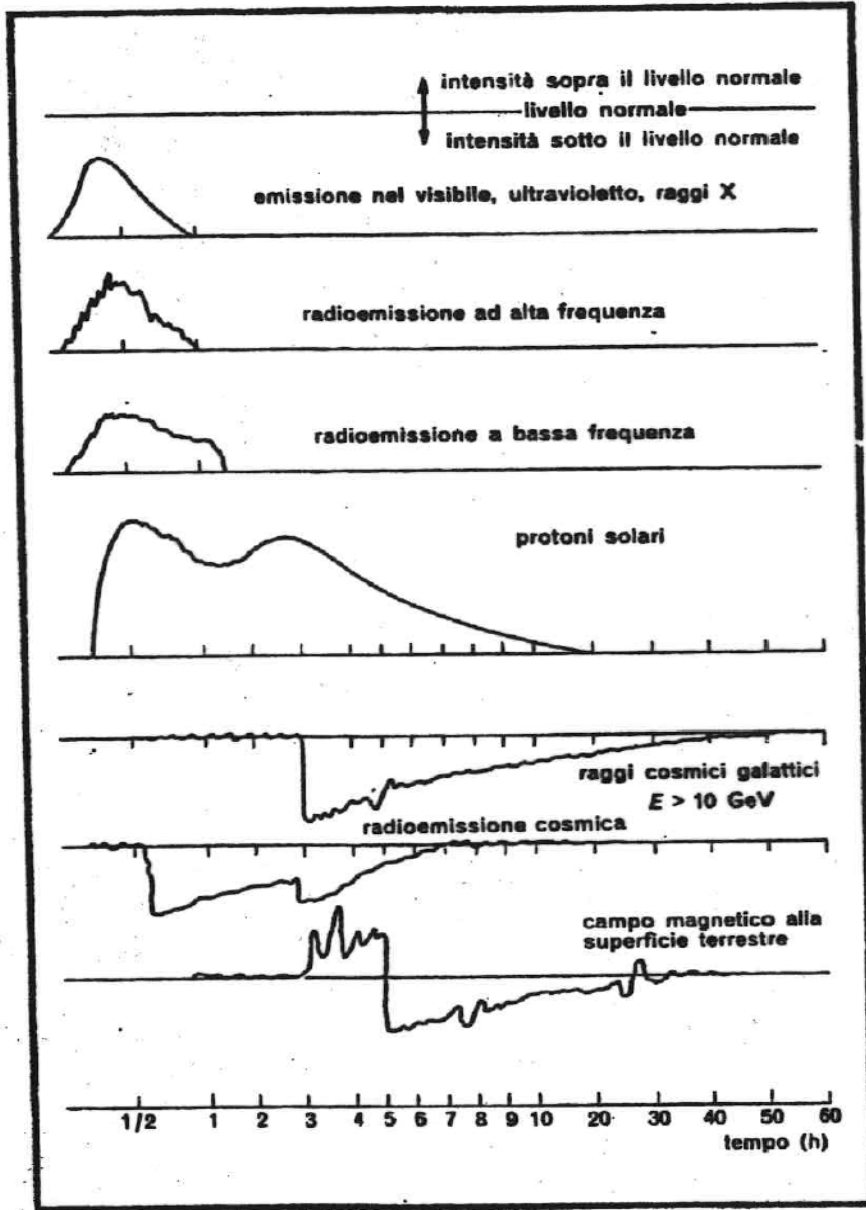

**Fig.7** I diversi effetti prodotti sulla radiazione cosmica e registrati durante un medesimo brillamento solare. Le linee orizzontali stanno a indicare il livello normale della radiazione stessa.

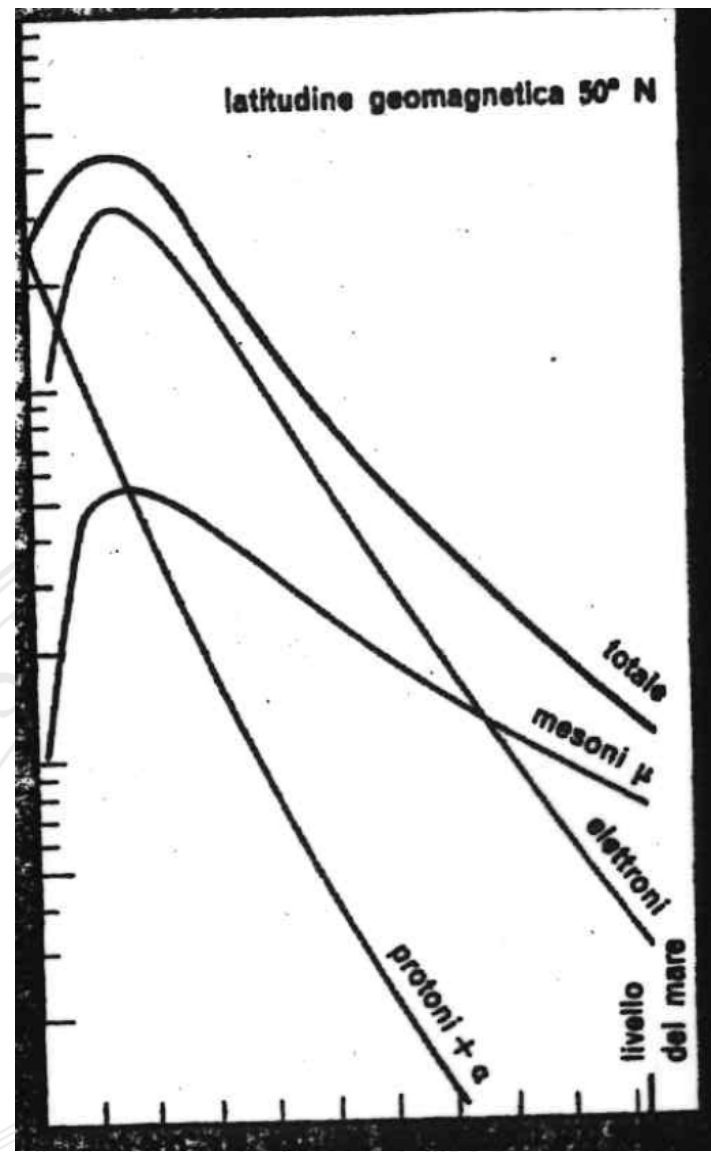

Sviluppo nell'atmosfera della componente secondaria carica



# RAGGI COSMICI

Figure I. Variation in solar activity in terms of the historical monthly average sunspot numbers during solar cycles [N4]

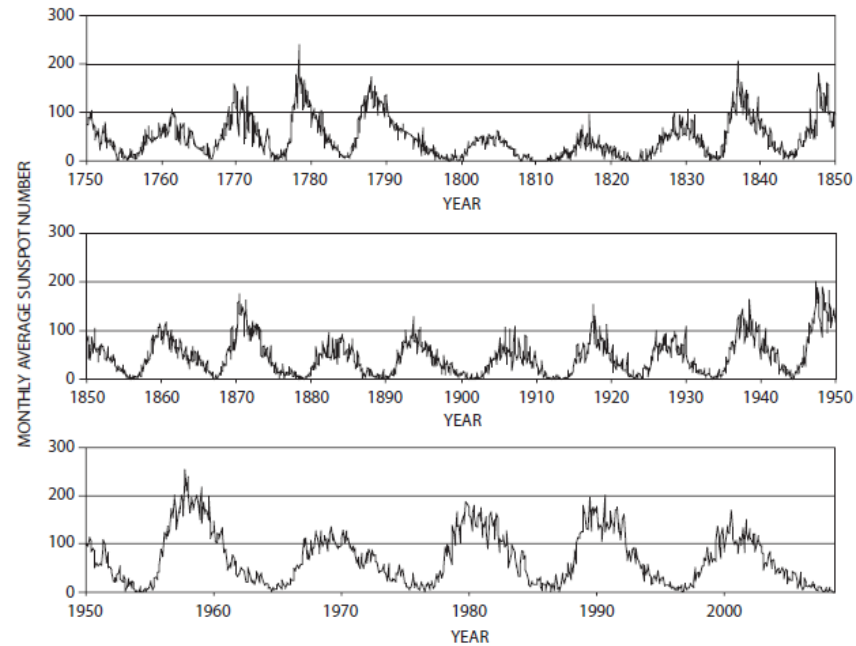
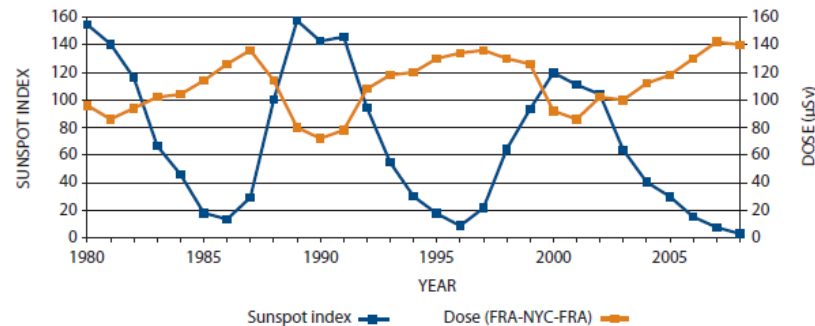

Figure II. Example of the influence of variation in solar activity on cosmic ray dose received during a return transcontinental flight between Frankfurt and New York City [S38]



# RAGGI COSMICI

Route	Subsonic flight at 36,000 ft (11 km)			Supersonic flight at 62,000 ft (19 km)		
	Flight duration (hrs)	Dose per round trip		Flight duration (hrs)	Dose per round trip	
		(mrad)	( $\mu$ Gy)		(mrad)	( $\mu$ Gy)
<b>Los Angeles - Paris</b>	11.1	4.8	48	3.8	3.7	37
<b>Chicago - Paris</b>	8.3	3.6	36	2.8	2.6	26
<b>New York - Paris</b>	7.4	3.1	31	2.6	2.4	24
<b>New York - London</b>	7.0	2.9	29	2.4	2.2	22
<b>Los Angeles - New York</b>	5.2	1.9	19	1.9	1.3	13
<b>Sydney - Acapulco</b>	17.4	4.4	44	6.2	2.1	21

# RADIONUCLIDI COSMOGENICI

Sono prodotti principalmente dalla interazione dei raggi cosmici con i nuclei presenti nell'atmosfera.

Si formano prevalentemente per l'interazione di neutroni. Ad esempio:

C-12 (n,2n) C-11

C-12 (n,2n  $\alpha$ ) Be-7 ;

N-14 (n,p) C-14

## Dati relativi ad alcuni radionuclidi cosmogenici (dati UNSCEAR 82)

Radionuclide	Tempo di dimezzamento	Numero totale di atomi prodotti nell'atmosfera per unità di tempo e di superficie terrestre ( $m^{-2} s^{-1}$ )	Inventario globale (PBq)	Attività per unità di volume di aria ( $\mu Bq m^{-3}$ )	Attività per unità di volume nelle acque della superficie continentale ( $Bq m^{-3}$ )	Attività specifica nella biosfera terrestre ( $Bq kg^{-1}$ )
H-3	12.3 a	2500	1300		200 ÷ 900	
Be-7	53.6 g	810	37	3000		
C-14	5730 a	16000 ÷ 25000	8500			230
Na-22	2.62 a	0.86	0.4	0.3		

# RADIONUCLIDI PRODOTTI IN ATMOSFERA DALLA RADIAZIONE COSMICA (MOE)

$^3\text{H}$	12.5 a	$\beta$ 18 keV	spallazione di C, O, N e Ar <sup>I</sup>	$(0,25 \pm 0,05)$	3,5 kg
$^7\text{Be}$	53 d	$\gamma$ 48 keV	spallazione di C, O, N e Ar <sup>I</sup>	$(8,2 \times 10^{-2})$	3.2 g
$^{10}\text{Be}$	$2,7 \cdot 10^6$ a	$\beta$ 550 keV	spallazione di C, O, N e Ar <sup>I</sup>	$5 \times 10^{-2}$	450 t
$^{14}\text{C}$	5570 a	$\beta^-$ 156 keV	spallazione $^{14}\text{N}$ (n,p), $^{14}\text{C}$	1.8	54 t
$^{22}\text{Na}$	2.6 a	$\left\{ \begin{array}{l} \beta^+ 540 \text{ keV} \\ \gamma 1,3 \text{ MeV} \end{array} \right.$	spallazione argo	$5,6 \times 10^{-5}$	1.2 kg
$^{32}\text{P}$	14.3 d	$\beta^-$ 1.7 MeV	spallazione argo	$8,1 \times 10^{-4}$	0.4 g
$^{33}\text{P}$	25 d	$\beta^-$ 250 keV	spallazione argo	$6,8 \times 10^{-4}$	0.6 g
$^{32}\text{Si}$	710 a	$\beta^-$ 100 keV	spallazione argo	$1,6 \times 10^{-4}$	1.4 kg
$^{35}\text{S}$	87 d	$\beta^-$ 167 keV	spallazione argo	$1,4 \times 10^{-3}$	4.5 g
$^{36}\text{Cl}$	$3,1 \cdot 10^5$	$\beta^-$ 714 keV	$\left\{ \begin{array}{l} \text{spallazione argo;} \\ \text{cattura n da } ^{35}\text{Cl} \\ \text{sulla Terra} \end{array} \right.$	$1,1 \times 10^{-3}$	15 t <sup>2</sup>
$^{39}\text{Cl}$	55 min	$\beta^-$ 1.5 MeV	spallazione argo $^{40}\text{Ar}$ ( $\mu^-, n$ ), $^{39}\text{Cl}$	$1,6 \times 10^{-2}$	2.5 mg



# Dati relativi alla ricaduta radioattiva di Fukushima

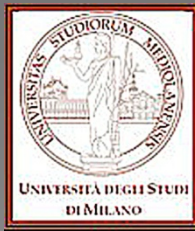

Flavia Groppi, Simone Manenti, Mauro L. Bonardi, Luigi Gini  
*Laboratorio Acceleratori e Superconduttività Applicata – L.A.S.A.,*  
Alexandra Ioannidou – *Aristotle University of Thessaloniki, Greece*



# Fukushima Nuclear Accident

unscear.org



## Background

- 11 March 2011 earthquake 9.0 and tsunami
  - >500 square kilometres flooded
  - 20,000 lives lost
- Worst civil nuclear accident since Chernobyl in 1986
  - Three of six reactor cores severely damaged
  - Large radioactive releases (about 10-20% of Chernobyl)



# Fukushima Nuclear Accident



Challenge: Speed at which risk and crisis information flows through the media

- 20 years ago: 24 hours
- 10 years ago: 4 hours
- Today (2014): 4 minutes



# 1ACFM Cascade Impactor 8-stage and a backup Filter



**GELMAN SAMPLERS —  
SIMULATE HUMAN  
RESPIRATORY SYSTEM**  
(Fractionation cut points at 1 ACFM)

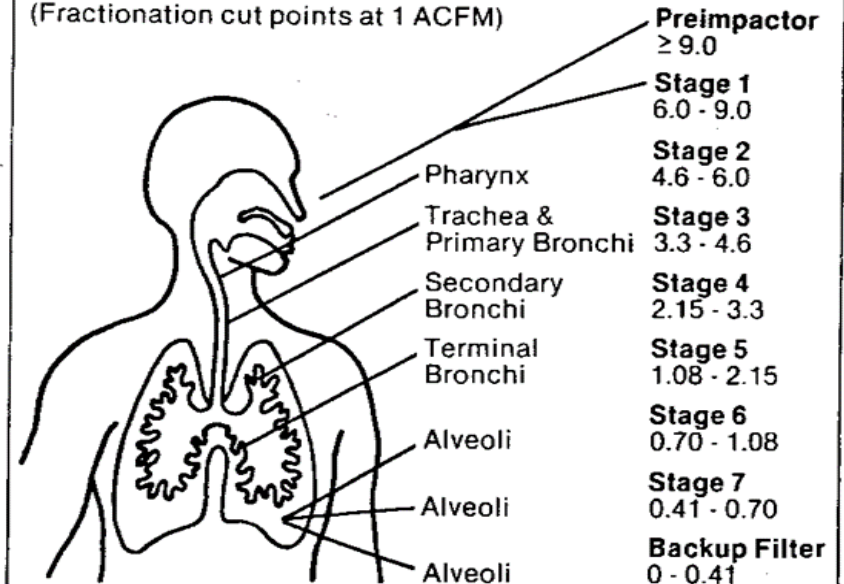

**GELMAN AMBIENT SAMPLER WITH  
FLOW CONTROLLED VACUUM**

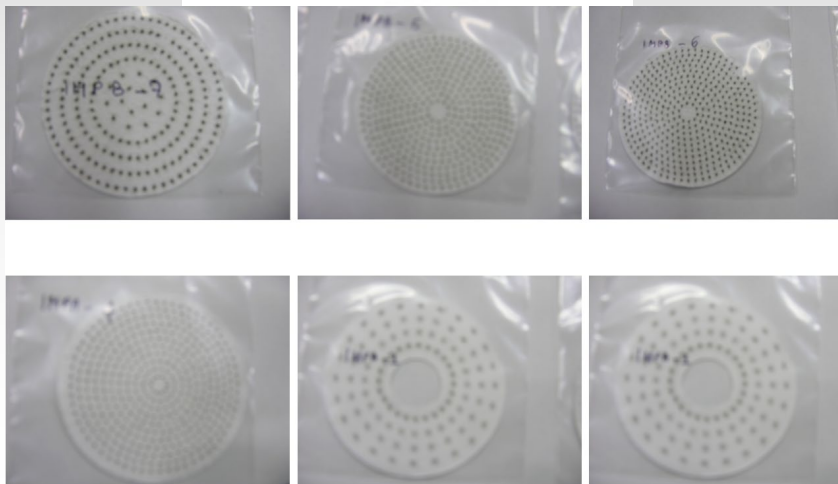
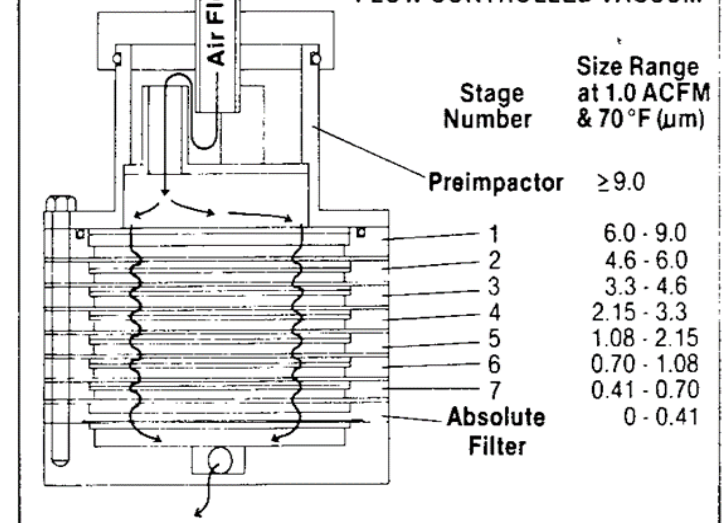



# Activity concentrations of $^{131}\text{I}$ , $^{137}\text{Cs}$ and $^{134}\text{Cs}$ in air



## HV air Sampler (Staplex TFIA-2)

Flow rate: 1.6-1.7 m<sup>3</sup>/min (60cfm)

Sampling duration: 23 h

Total Volume: 2400-2700 m<sup>3</sup>

Air Volume Uncertainty ( $2\sigma$ ): 30-50 m<sup>3</sup>

Position: Thessaloniki 40°N, Milano 45°N



## Glass Fiber Filters TFAGF810

Very high retention of fine particles. 99.98% retention efficiency of 0.3 micron particles.

# Air-filters analysis by gamma ray spectra

Air filters are measured at least 10h after the end of sampling

I-131 (364 keV)

Cs-137(662 keV)

Cs134 (605 keV & 796 keV) correction due to summation effect

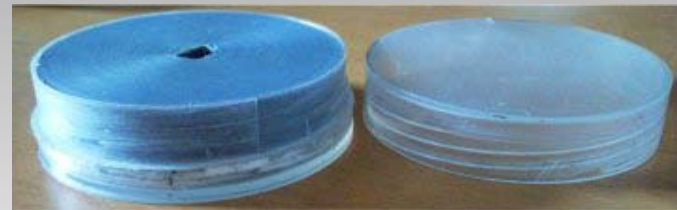

# Activity concentrations of $^{131}\text{I}$ , $^{137}\text{Cs}$ and $^{134}\text{Cs}$ in air

Date of sampling	Fallout isotopes in surface air				
	$^{131}\text{I}$ $\mu\text{Bq m}^{-3}$	$^{137}\text{Cs}$ $\mu\text{Bq m}^{-3}$	$^{134}\text{Cs}$ $\mu\text{Bq m}^{-3}$	ratio $^{134}\text{Cs}/^{137}\text{Cs}$	ratio $^{131}\text{I}/^{137}\text{Cs}$
31/03/11	322±35	< 29 <sup>a</sup>	< 26 <sup>a</sup>	-	-
02/04/11	335±89	59±42	56±37	0.95	5.7
03/04/11	467±25	40±9	37±8	0.92	11.7
05/04/11	323±16	25±9	27±9	1.09	12.9
07/04/11	438±28	26±17	25±15	0.98	16.8
09/09/11	209±33	56±30	54±24	0.97	3.7
10/04/11	229±55	63±30	61±22	0.97	3.6
11/04/11	285±43	<sup>b</sup> 27±18	<sup>b</sup> 23±14	0.90	10.6
12/04/11	333±73	60±38	56±30	0.94	5.6
14/04/11	343±48	57±26	54±23	0.95	6.0
15/04/11	220±58	47±27	42±20	0.89	4.7
16/04/11	161±34	39±10	<sup>b</sup> 13±7	0.33	4.1
17/04/11	118±27	44±17	31±13	0.69	2.7
19/04/11	107±30	29±16	40±14	1.38	3.7
20/04/11	107±38	38±16	23±12	0.62	2.8
21/04/11	128±33	<sup>b</sup> 17±16	27±14	1.59	7.5
22/04/11	94±46	35±16	< 11 <sup>a</sup>	-	2.7
28/04/11	<sup>b</sup> 60±35	<sup>b</sup> 23±16	< 12 <sup>a</sup>	-	2.6
29/04/11	< 41 <sup>a</sup>	< 11	33±14	-	-
30/04/11	< 19 <sup>a</sup>	< 16 <sup>a</sup>	< 12 <sup>a</sup>	-	-
3/05/11	< 9 <sup>a</sup>	17±16	22±14	1.34	-

<sup>a</sup> MDA

<sup>b</sup> Critical Level

$$^{134}\text{Cs}/^{137}\text{Cs} = 1$$

Related to the burn-up history of the nuclear fuel of the destroyed nuclear reactor

$$^{131}\text{I} < 500 \mu\text{Bq m}^{-3}$$

$^{131}\text{I}/^{137}\text{Cs}$  decrease with time

Reflects the different volatility, attachment and removal of the two isotopes during transportation due to their different physico-chemical properties.

# $^{134}\text{Cs}/^{137}\text{Cs}$ activity ratio = 1

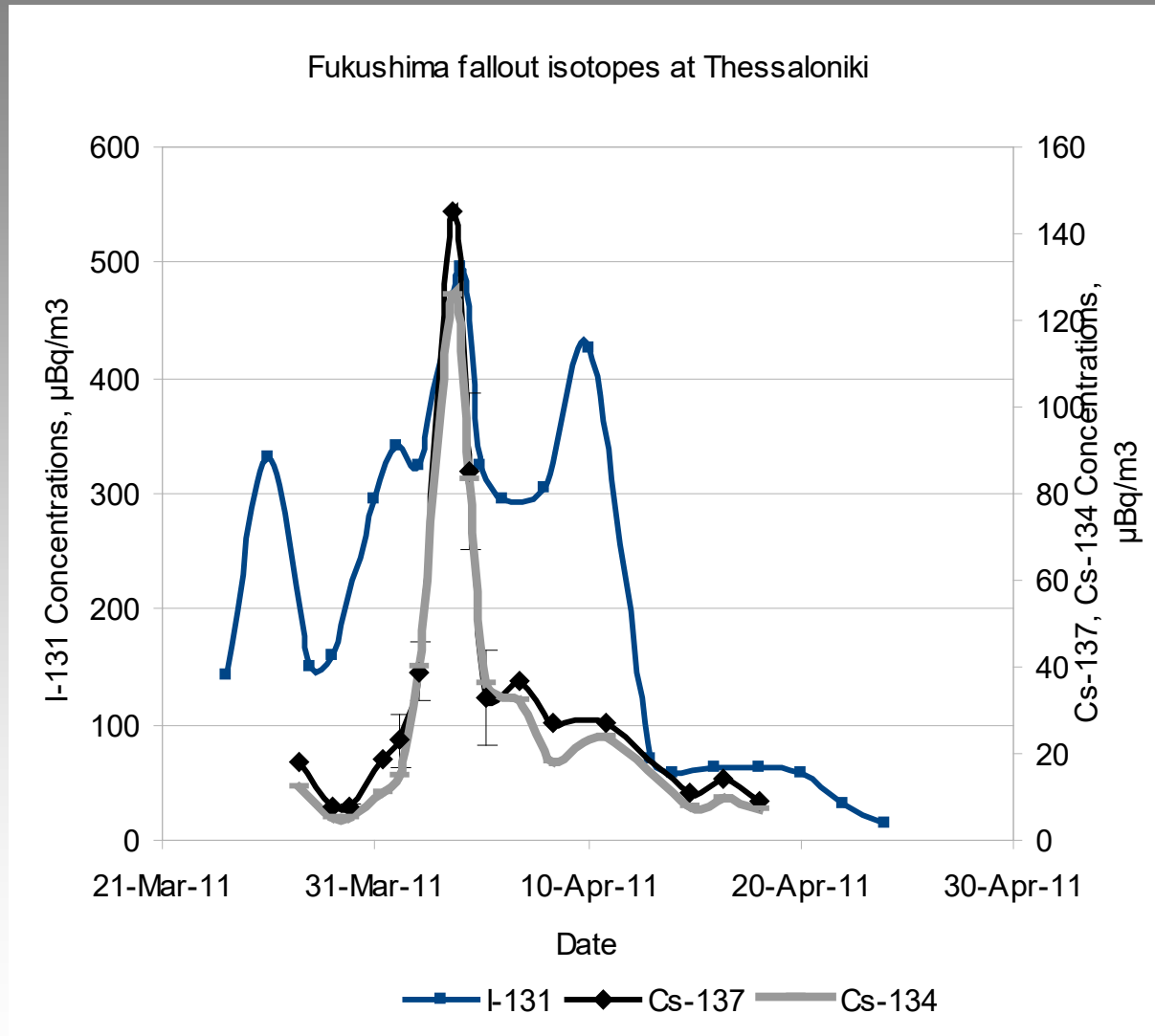

# $^{131}\text{I}$ atmospheric concentrations

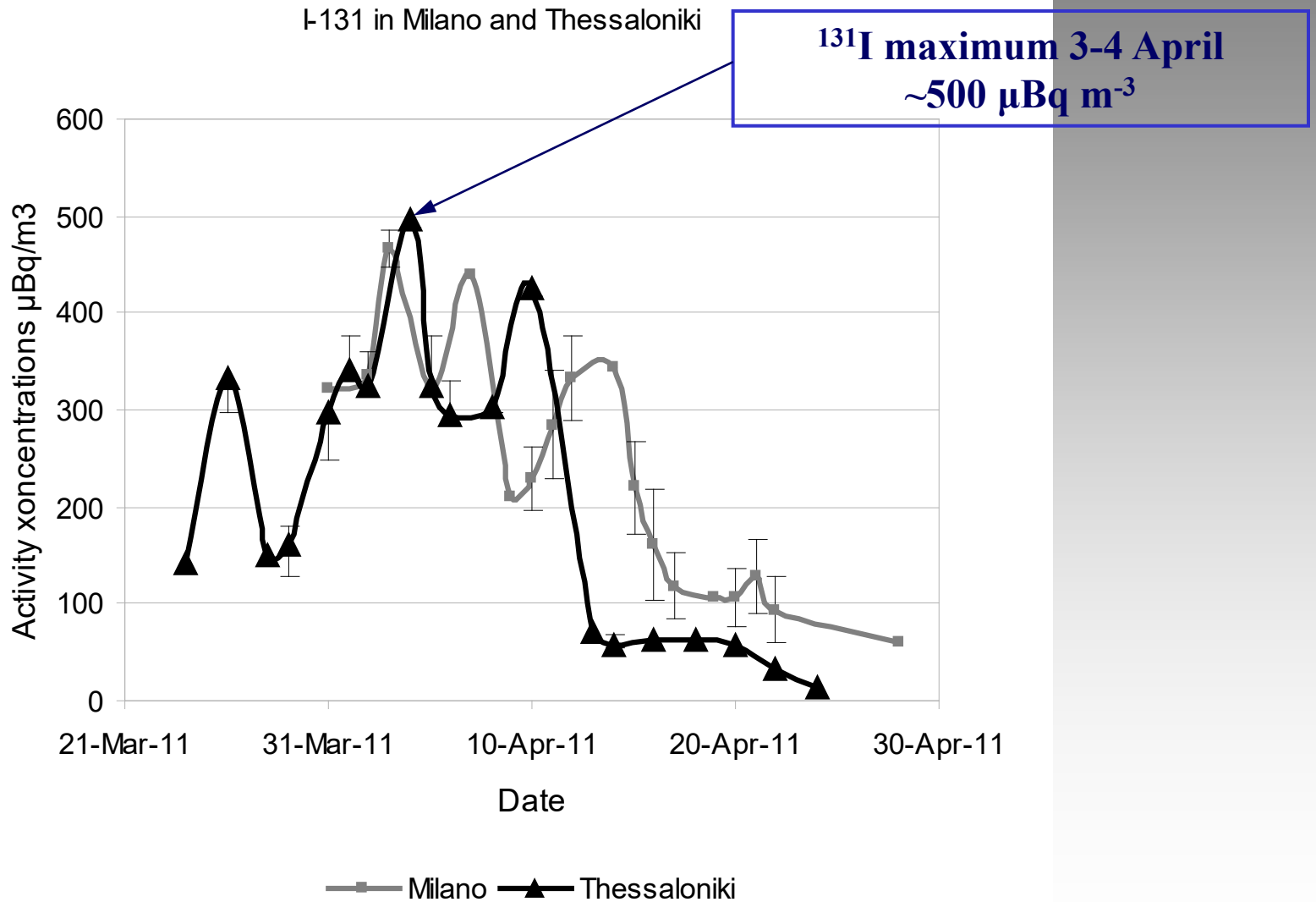

# Back trajectories analysis

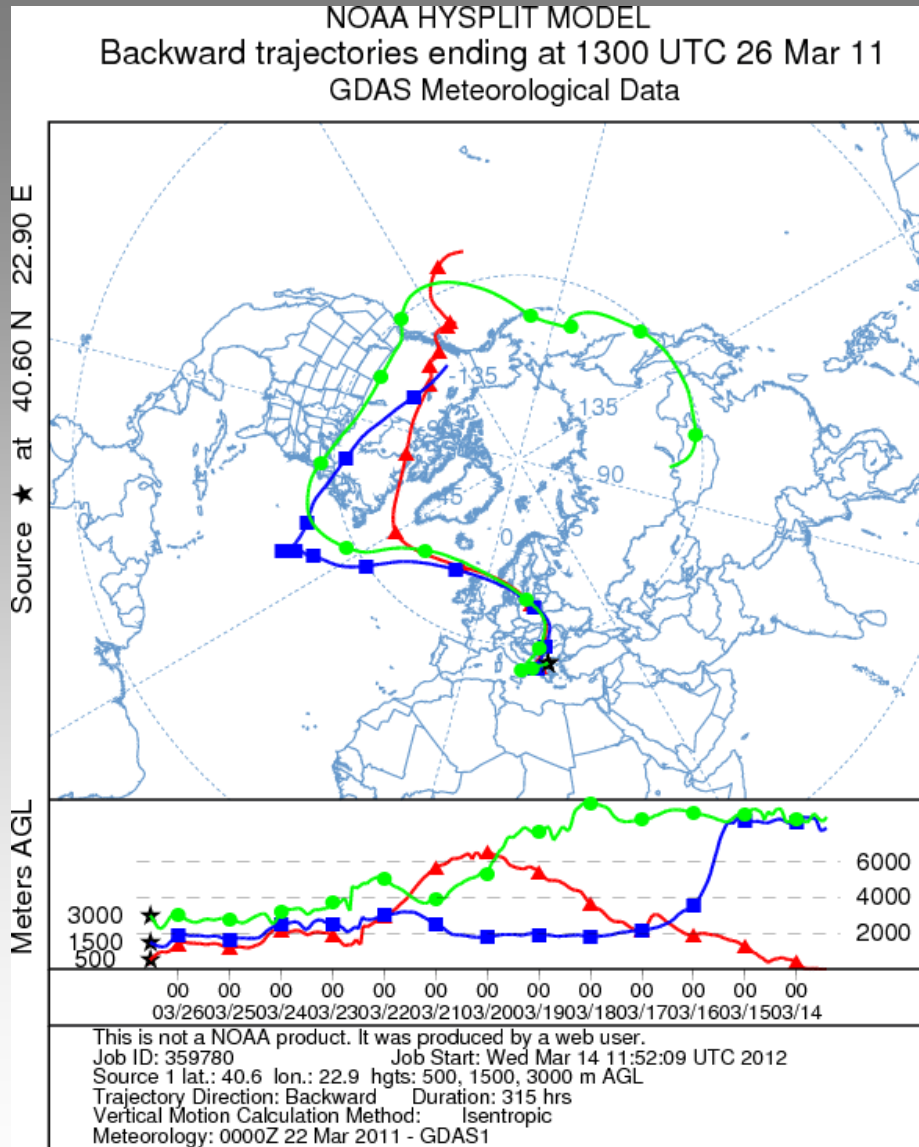

The NOAA HYSPLIT model was used to assess the transport pattern and to explain the deviation in radionuclide activity concentrations found.

Thirteen days (312) back trajectories were calculated for different arrival height and for 12 UTC time.

The trajectories are labeled every 24h by a filled symbol.

# Back trajectories analysis

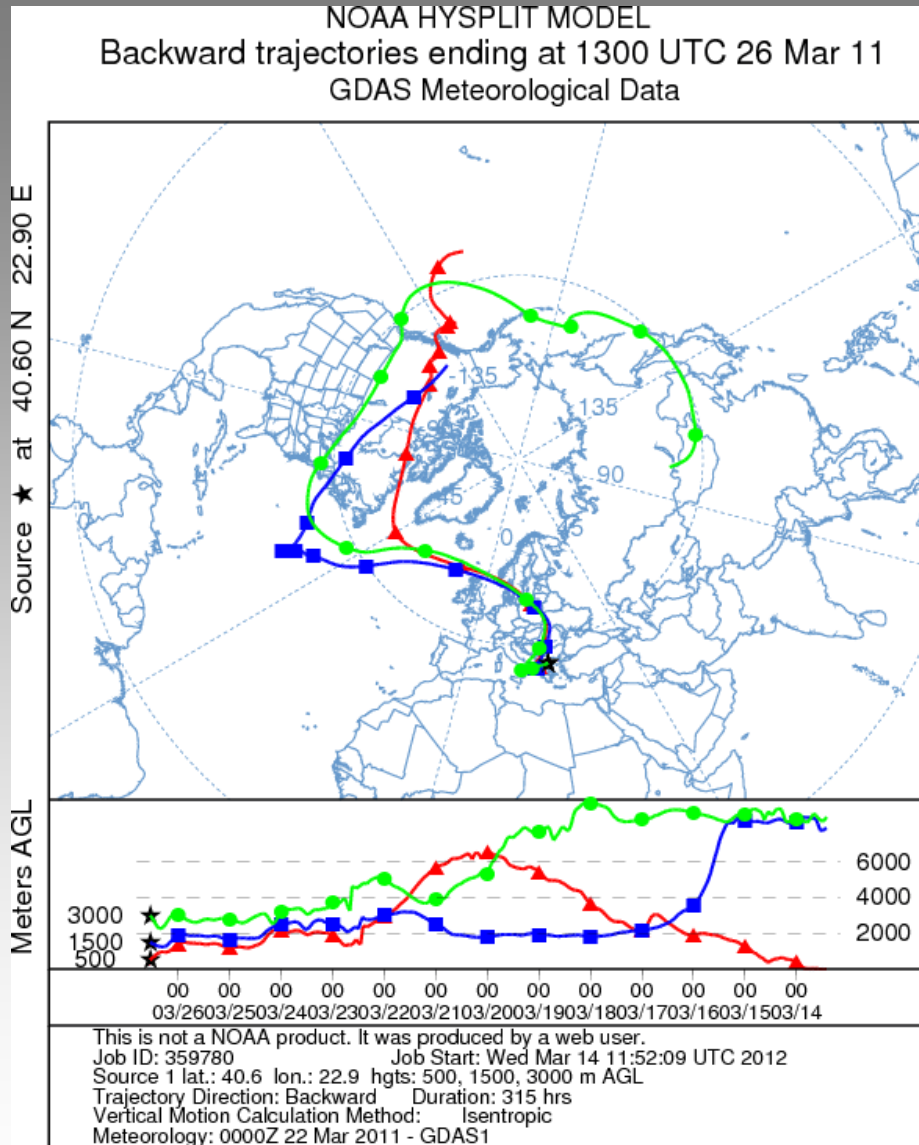

The first maximum in concentration of  $^{131}\text{I}$  ( $332 \mu\text{Bq m}^{-3}$ ) was observed at Thessaloniki on **26th of March 2011**. Air masses were lifted rapidly and transported over the North America to Europe at height of 500 m. Air masses were also traveled at higher atmosphere levels from Japan. It is also possible that radioactive particles were transported at higher altitudes and may have been removed in the lower layer of the atmosphere due to various reasons, e.g. rainfall characteristics, fog formation or growth of aerosol particles and their deposition.

# Back trajectories analysis

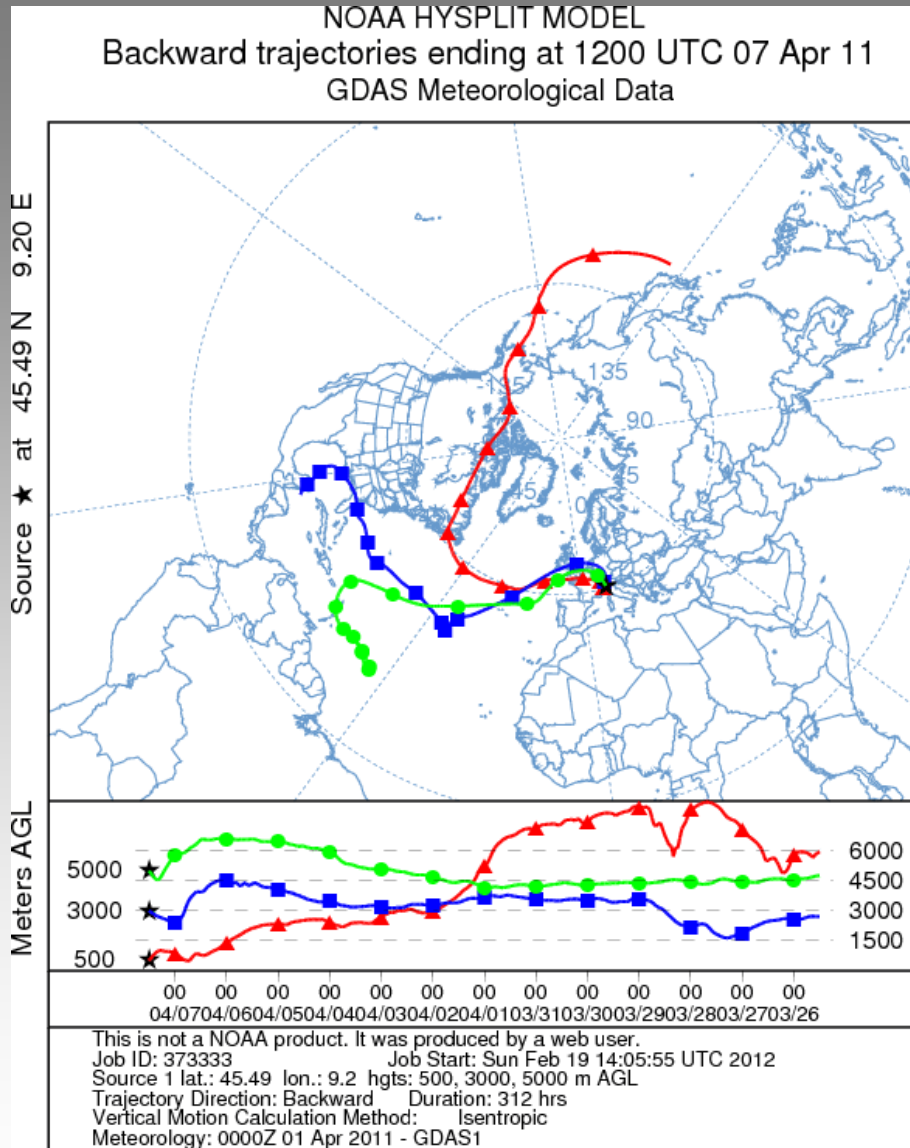

An example of transported air mass at **07 of April 2011** at Milano is presented.

The results showed a direct transfer from Fukushima across the Pacific Ocean, a transport through the North Pole and a pathway through the Greenland and Iceland at height of 500 m to Milano.

The air masses at higher altitudes were rapidly transported, while the air masses at 500 m exhibited rather slow transport.



# Back trajectories analysis

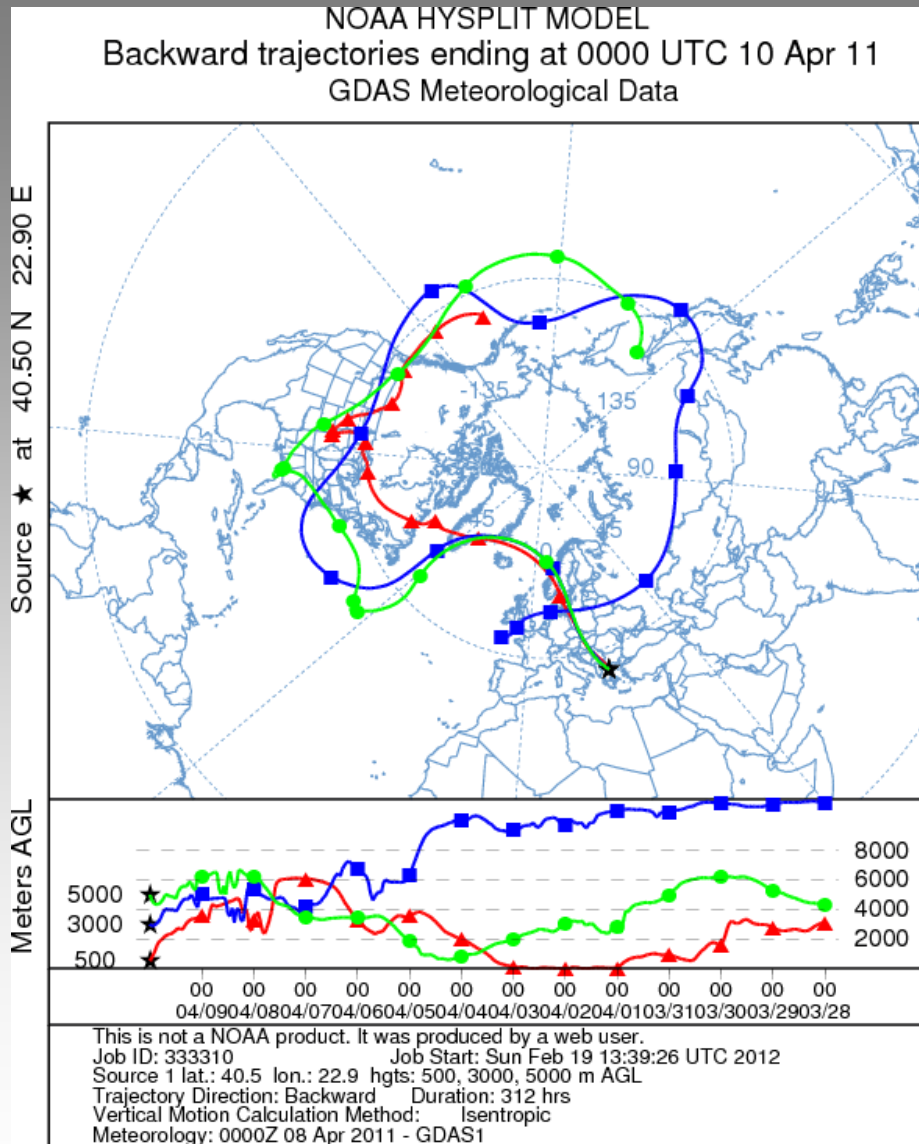

On **10th of April** back-trajectory analysis showed a direct transfer from Fukushima across the Pacific Ocean, a transport through the North Pole and a pathway through the Greenland and Iceland to Thessaloniki.

The air masses on that day reach Thessaloniki from Northwest direction and this is possible the reason why no maximum concentration was observed at Milan.

# Wet deposition of $^{131}\text{I}$ , $^{137}\text{Cs}$ and $^{134}\text{Cs}$

Fallout isotopes in rainwater samples						
Site	Date of Sampling	Volume	Surface area $\text{m}^2$	$^{131}\text{I}$ $\text{mBq L}^{-1}$ ( $\text{Bq m}^{-2}$ )	$^{137}\text{Cs}$ $\text{mBq L}^{-1}$ ( $\text{Bq m}^{-2}$ )	$^{134}\text{Cs}$ $\text{mBq L}^{-1}$ ( $\text{Bq m}^{-2}$ )
Segrate	28/03/11	0.685	0.1739	$891 \pm 115$ ( $3.51 \pm 0.45$ )	$^{b}122 \pm 89$ ( $0.48 \pm 0.35$ )	$< 58^a$ ( $< 0.23$ )
Senago	28/03/11	0.500	0.1739	$725 \pm 133$ ( $2.08 \pm 0.38$ )	$< 11^a$ ( $< 0.03$ )	$< 86^a$ ( $< 0.25$ )
Segrate	12/04/11	0.016	0.5217	$< 36^a$ ( $< 0.011$ )	$859 \pm 435$ ( $0.271 \pm 0.137$ )	$< 308^a$ ( $< 0.097$ )
Segrate	15/04/11	0.925	0.5217	$291 \pm 87$ ( $0.52 \pm 0.15$ )	$45 \pm 32$ ( $0.08 \pm 0.06$ )	$57 \pm 26$ ( $0.10 \pm 0.05$ )

<sup>a</sup> MDA

<sup>b</sup> Critical Level

$^{131}\text{I} < 1 \text{ Bq L}^{-1}$

The Food and Drug Administration (FDA) fixed intervention level for  $^{131}\text{I}$  in drinking water and infant milk, **to  $170 \text{ Bq L}^{-1}$**  while in Japan, the  **$^{131}\text{I}$  limit for consumption of tap water is  $100 \text{ Bq L}^{-1}$  for infants, and  $300 \text{ Bq L}^{-1}$  for adults** (RIKEN, 2011).

# Dry deposition of $^{131}\text{I}$ , $^{137}\text{Cs}$ and $^{134}\text{Cs}$

Date of Sampling	Fallout isotopes in dry deposition samples			
	$^{131}\text{I}$ Bq m <sup>-2</sup>	$^{137}\text{Cs}$ Bq m <sup>-2</sup>	$^{134}\text{Cs}$ Bq m <sup>-2</sup>	ratio $^{134}\text{Cs}/^{137}\text{Cs}$
06/04/11	0.40±0.16	0.24±0.11	< 0.05 <sup>a</sup>	-

Dry Deposition:

$^{131}\text{I}$ : 11% of wet

$^{137}\text{Cs}$ : 50% of wet

➤ If these data are compared with the ones obtained by rainwater, it is clear that the dry deposition of  $^{137}\text{Cs}$  and  $^{134}\text{Cs}$  is greater than that of  $^{131}\text{I}$ .

➤ This can be explained because, contrary to the iodine mainly found in gaseous form, caesium is rapidly bound to aerosols and thus highly subject to dry deposition.

# $^{131}\text{I}$ , $^{137}\text{Cs}$ and $^{134}\text{Cs}$ in soil

Site	Date of Sampling	Fallout isotopes in soil samples			
		$^{131}\text{I}$ Bq kg <sup>-1</sup>	$^{137}\text{Cs}$ Bq kg <sup>-1</sup>	$^{134}\text{Cs}$ Bq kg <sup>-1</sup>	ratio $^{137}\text{Cs}/^{134}\text{Cs}$
Segrate	30/03/11	0.63±0.29	12.26±0.70	0.83±0.30	0.07
Senago uncovered	04/04/11	0.57±0.25	85.17±4.40	0.29±0.13	0.0034
Senago covered	04/04/11	<0.15 <sup>a</sup>	84.65±4.40	0.47±0.28	0.01
Segrate <sup>b</sup>	06/04/11	0.85±0.34	18.73±1.02	<sup>c</sup> 0.48±0.27	0.03
Segrate	13/04/11	0.95±0.60	18.65±1.04	< 0.21 <sup>a</sup>	-
Segrate	20/04/11	1.99±1.32	19.08±1.05	< 0.19 <sup>a</sup>	-
Segrate	04/05/11	< 0.24 <sup>a</sup>	9.62±0.56	0.45±0.19	0.05
Segrate	11/05/11	< 0.21 <sup>a</sup>	11.99±0.63	< 0.06	-
Segrate	18/05/11	< 0.48 <sup>a</sup>	24.95±1.30	< 0.07	-

<sup>a</sup> MDA

<sup>b</sup> Sample taken in an unplowed area

<sup>c</sup> Critical Level

Dry Deposition:

$^{131}\text{I}$ : 0.70 Bq m<sup>-2</sup>

# $^{131}\text{I}$ , $^{137}\text{Cs}$ and $^{134}\text{Cs}$ in grass - LASA

Date of Sampling	Fallout isotopes in grass samples			
	$^{131}\text{I}$ mBq kg <sup>-1</sup>	$^{137}\text{Cs}$ mBq kg <sup>-1</sup>	$^{134}\text{Cs}$ mBq kg <sup>-1</sup>	ratio $^{134}\text{Cs}/^{137}\text{Cs}$
30/03/11	66±24	47±19	<18 <sup>a</sup>	-
06/04/11	<sup>b</sup> 37±33	60±20	<sup>b</sup> 21±17	0.3
13/04/11	<51 <sup>a</sup>	<sup>b</sup> 41±35	<30 <sup>a</sup>	-
20/04/11	<sup>b</sup> 135±119	89±32	<21 <sup>a</sup>	-

Total surface: 1 m<sup>2</sup>

Total mass: 0.35-0.45 kg

Surface deposition

$^{131}\text{I}$ : 0.016-0.029 Bq m<sup>-2</sup>

$^{137}\text{Cs}$ : 0.014-0.026 Bq m<sup>-2</sup>

Dry Deposition:

$^{131}\text{I}$ : 0.40 Bq m<sup>-2</sup>

$^{137}\text{Cs}$ : 0.24 Bq m<sup>-2</sup>

# Activity concentrations of $^{131}\text{I}$ , $^{137}\text{Cs}$ and $^{134}\text{Cs}$ in snow

Samples collected at 3000 m s.l.m.  
Monte Moro - Macugnaga (VB), Italy



# Activity concentrations of $^{131}\text{I}$ , $^{137}\text{Cs}$ and $^{134}\text{Cs}$ in snow

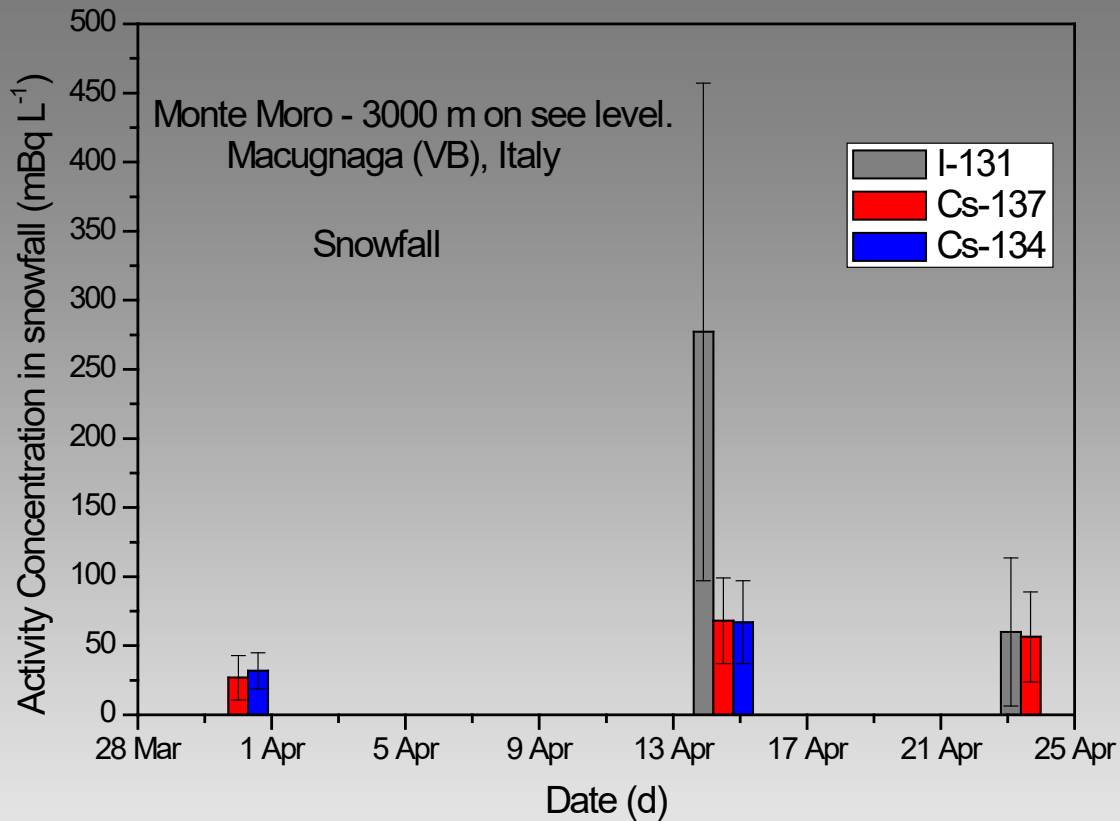

Date of Sampling	Fallout isotopes in snowfall samples			
	$^{131}\text{I}$ mBq L <sup>-1</sup>	$^{137}\text{Cs}$ mBq L <sup>-1</sup>	$^{134}\text{Cs}$ mBq L <sup>-1</sup>	ratio $^{134}\text{Cs}/^{137}\text{Cs}$
28/03/11	< 12.04 <sup>a</sup>	< 8.98 <sup>a</sup>	< 6.92 <sup>a</sup>	
31/03/11	< 20.88 <sup>a</sup>	27±16	<sup>b</sup> 32 ±13	1.19
14/04/11	277±180	68±31	67±30	0.98
23/04/11	<sup>b</sup> 60±53	56±33	< 29 <sup>a</sup>	

# $^{131}\text{I}$ , $^{137}\text{Cs}$ and $^{134}\text{Cs}$ in milk

Samples of sheeps and cows milk collected in Val Anzasca (VB), Italy at 400 m s.l.m.

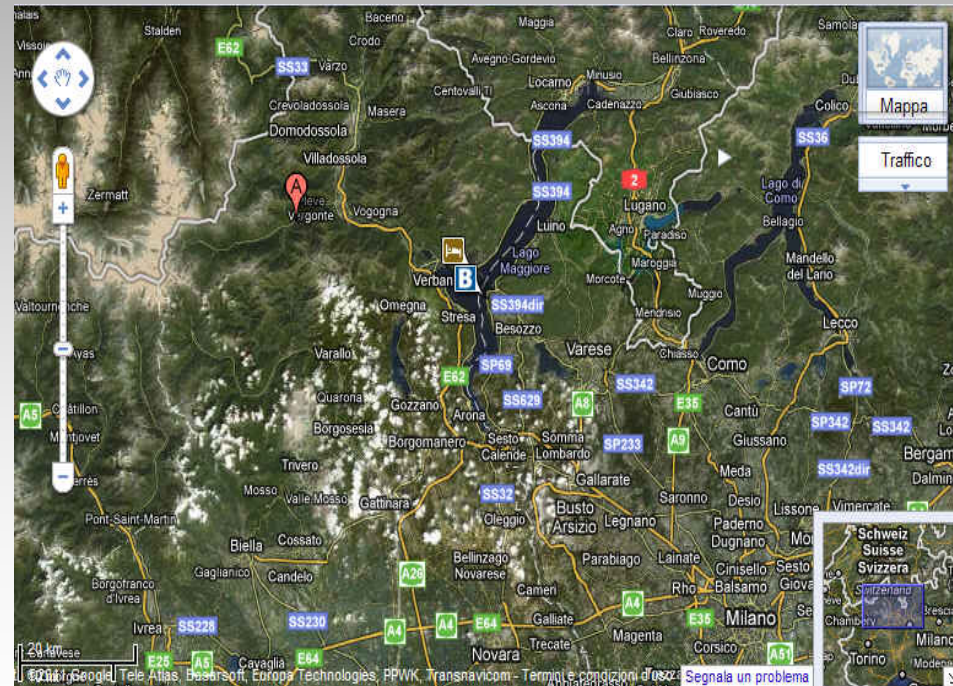



# $^{131}\text{I}$ , $^{137}\text{Cs}$ and $^{134}\text{Cs}$ in milk

Fallout isotopes in milk samples								
Date of Sampling	Goat Milk				Cow Milk			
	$^{131}\text{I}$ mBq L <sup>-1</sup>	$^{137}\text{Cs}$ mBq L <sup>-1</sup>	$^{134}\text{Cs}$ mBq L <sup>-1</sup>	Ratio $^{134}\text{Cs}/^{137}\text{Cs}$	$^{131}\text{I}$ mBq L <sup>-1</sup>	$^{137}\text{Cs}$ mBq L <sup>-1</sup>	$^{134}\text{Cs}$ mBq L <sup>-1</sup>	Ratio $^{134}\text{Cs}/^{137}\text{Cs}$
9/04/11	246±107	481±52	< 33 <sup>a</sup>	-	208± 97	333±44	< 31 <sup>a</sup>	
1/05/11	101±68	506±48	< 26 <sup>a</sup>		<sup>b</sup> 68±67	421±44	< 31 <sup>a</sup>	
8/05/11	87±72	448±47	< 26 <sup>a</sup>		< 40 <sup>a</sup>	263±39	< 26 <sup>a</sup>	
16/05/11	< 24 <sup>a</sup>	526 ±50	< 30 <sup>a</sup>		< 38 <sup>a</sup>	302±47	67±35	0.22
21/05/11	<sup>b</sup> 77±73	527±63	<sup>b</sup> 59±44	0.11	< 53 <sup>a</sup>	684±54	< 28 <sup>a</sup>	
29/05/11	60±46	474±47	69 ±26	0.15	110±58	473±44	< 27 <sup>a</sup>	
05/06/11	< 25 <sup>a</sup>	398±44	< 33 <sup>a</sup>		< 34	354±41	< 27 <sup>a</sup>	
11/06/11	< 68 <sup>a</sup>	378±55	< 34 <sup>a</sup>		77±68	279±37	41±24	0.15
20/06/11	< 32 <sup>a</sup>	298±37	< 22 <sup>a</sup>		< 28 <sup>a</sup>	197 ±35	< 22 <sup>a</sup>	
26/06/11	< 29 <sup>a</sup>	460±45	< 25 <sup>a</sup>		81±60	283±64	< 34 <sup>a</sup>	
03/07/11	< 28	796±67	<sup>b</sup> 48±30		< 32 <sup>A)</sup>	296±36	< 0.23	

a. MDA  
b. Critical level

I-131 1200±350 mBq L<sup>-1</sup>

Cs-137 150±30 mBq L<sup>-1</sup>

# Activity concentrations of $^{131}\text{I}$ and $^{134,137}\text{Cs}$ in goat milk at Monte Rosa mountain, after the Fukushima nuclear accident

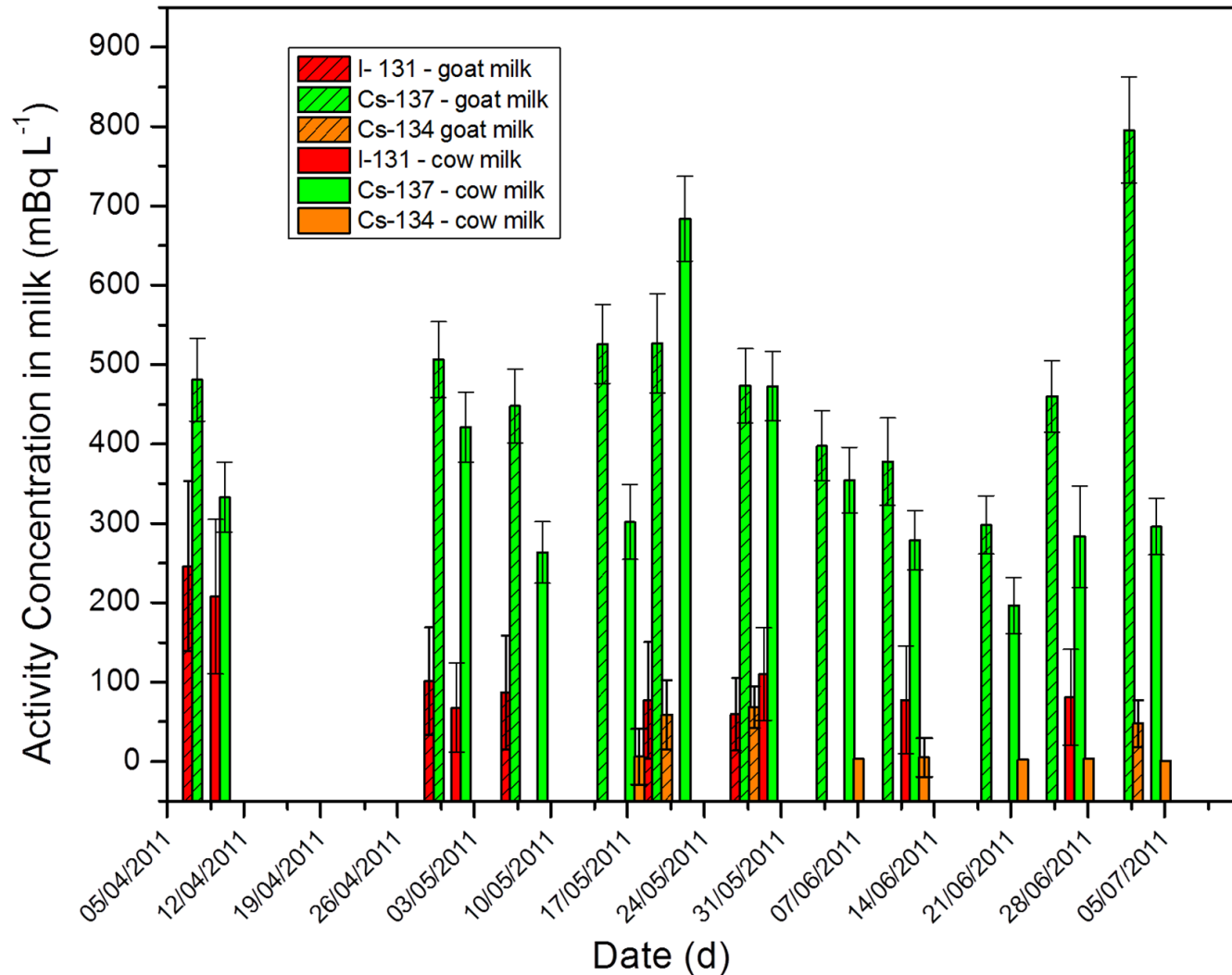

# Dose assessment

The limit of the effective dose for the population is fixed for the Italian Law of Radioprotection in **1 mSv a<sup>-1</sup>** (Italian Government Legislative Decree, 1995).

The evaluation of the effective dose is done by the relation:

$$E = E_{est} + \sum_j h(g)_{j,ing} J_{j,ing} + \sum_j h(g)_{j,inh} J_{j,inh} < 1 \text{ mSv a}^{-1}$$

where,  $E_{est}$  is the effective dose for exposure;

$J_{j,ing}$  and  $J_{j,inh}$  are the intake activity (Bq) by ingestion and by inhalation of radionuclide  $j$ , respectively;

$h(g)_{j,ing}$ ,  $h(g)_{j,inh}$  (Sv Bq<sup>-1</sup>) are the coefficients of committed dose for unit of intake by ingestion and/or by inhalation for the population of age group  $g$ , due to radionuclide  $j$ .

# Dose assessment

Coefficients of committed dose for unit of intake by ingestion and/or by inhalation for the population of age group  $g$ , for the radionuclides of interest, per unit of intake – Sv Bq<sup>-1</sup>

Nuclide	age < 1 a $h(g)_{ing}$	age > 17 a $h(g)_{ing}$	age < 1 a <sup>(*)</sup> $h(g)_{inh}$	age > 17 a <sup>(*)</sup> $h(g)_{inh}$
I-131	$1,8 \cdot 10^{-7}$	$2,2 \cdot 10^{-8}$	$7,2 \cdot 10^{-8}$	$7,4 \cdot 10^{-9}$
Cs-137	$2,1 \cdot 10^{-8}$	$1,3 \cdot 10^{-8}$	$8,8 \cdot 10^{-9}$	$4,6 \cdot 10^{-9}$
Cs-134	$2,6 \cdot 10^{-8}$	$1,9 \cdot 10^{-8}$	$1,1 \cdot 10^{-8}$	$6,6 \cdot 10^{-9}$

(\*) Fast Type of Absorption

Annual individual usage factors for external exposure, inhalation and consumption of foods. reported in NCRP-123 publication

Pathways - External <i>and</i> Inhalation	Unit	Exposure
Inhalation	m <sup>3</sup> a <sup>-1</sup>	8 000
Pathways - Ingestion	Unit	Intake
Water and beverages	L a <sup>-1</sup>	800
Milk	L a <sup>-1</sup>	300

# Dose assessment

The evaluation of the Effective Dose was done using the highest concentration value for  $^{131}\text{I}$ ,  $^{134}\text{Cs}$  and  $^{137}\text{Cs}$  measured, and are taken into account only the h(g) coefficients for population of age less than 1 year old and greater than 17 a.

Effective doses due to different pathways

Pathways	age < 1 a	age > 17 a
Air	$E = 0.2 \cdot 1_{I-1} + 4.7 \cdot 1_{C-1} + 0.5 \cdot 1_{C-1} = 0.3 \mu\text{S} \cdot \text{a}^{-1}$	$E = 3 \cdot 1_{I-1} + 2.3 \cdot 1_{C-1} + 3.2 \cdot 1_{C-B} = 3 \cdot 1_{I-1} \mu\text{S} \cdot \text{a}^{-1}$
Water	$E = 1 \cdot 0.3_{I-1} + 1 \cdot 8_{C-1} = 0.1 \mu\text{S} \cdot \text{a}^{-1}$	$E = 1 \cdot 0.7_{I-1} + 9.3_{C-1} = 2.8 \mu\text{S} \cdot \text{a}^{-1}$
Goat Milk	$E = 1 \cdot 0.3_{I-1} + 5.0_{C-1} + 0.4_{C-1} = 1 \cdot 7 \mu\text{S} \cdot \text{a}^{-1}$	$E = 1.6_{I-1} + 3.1_{C-1} + 0.3_{C-1} = 5.0 \mu\text{S} \cdot \text{a}^{-1}$
Cow Milk	$E = 1 \cdot 0.2_{I-1} + 4.3_{C-1} + 0.4_{C-1} = 1 \cdot 9 \mu\text{S} \cdot \text{a}^{-1}$	$E = 1.4_{I-1} + 2.7_{C-1} + 0.3_{C-1} = 4.3 \mu\text{S} \cdot \text{a}^{-1}$

< 1 mSv y<sup>-1</sup>

# Activity concentrations of $^{137}\text{Cs}$ in goat and cow milk at Monte Rosa mountain, after the Fukushima nuclear accident up to 2 years later

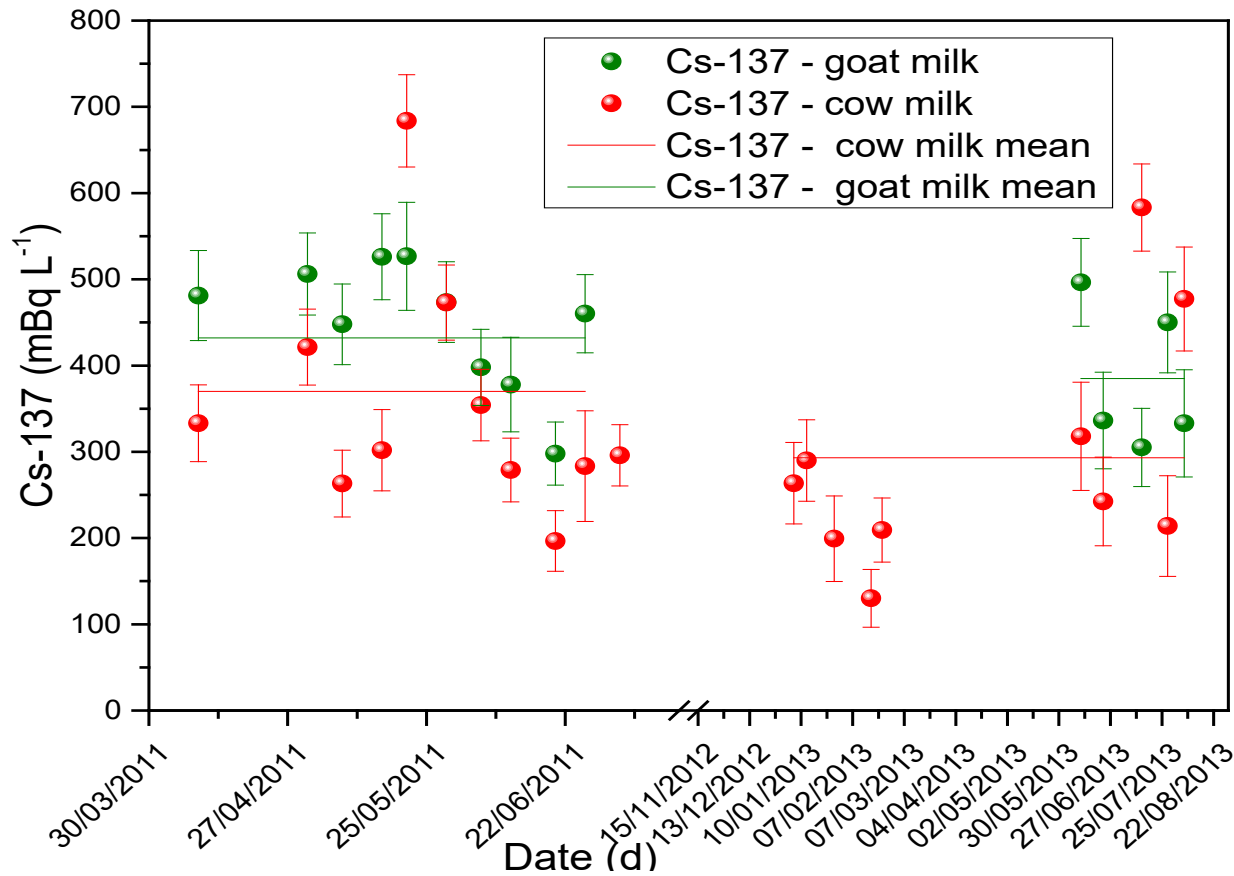

The relative high activity concentrations of  $^{137}\text{Cs}$  and the very low values of the activity ratio of  $^{134}\text{Cs}/^{137}\text{Cs}$ , in combination with the absence of  $^{134}\text{Cs}$  in most of the cases indicate a strong contribution from “older”  $^{137}\text{Cs}$  from the Chernobyl accident and past global fallout and not from Fukushima accident. Some measurements were conducted in order to find a correlation between the  $^{137}\text{Cs}$  concentration values and the animals pasture and environments which are utilized for food production (due to the pathway: fodder-animal-milk). Further research is necessary.

# Radioactivity measurement in environmental and food samples

Measurements of milk and derivatives to:

- . addresses the importance of food safety and risk assessment following nuclear incidents like Fukushima one;
- . quantify contamination levels, particularly in Northern Italy, providing valuable insights into the long-term persistence of radionuclides in food chains and their implications for human health.

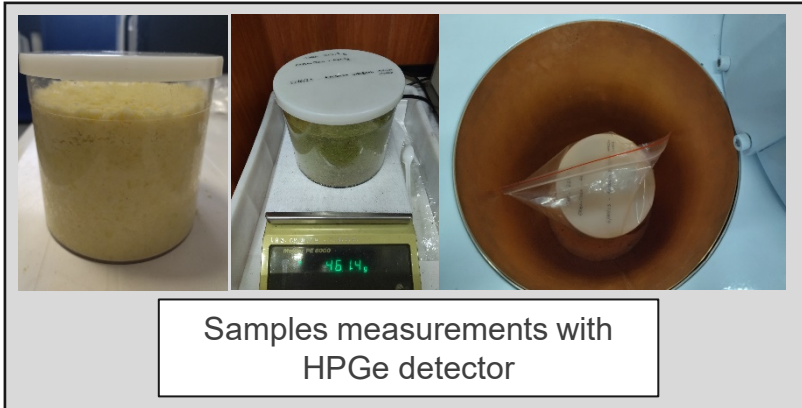

# Some results

Concentrations comparison in environmental matrices

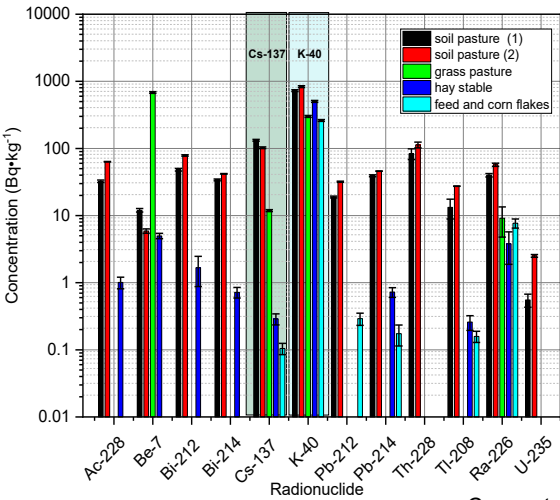

Cs-137 concentration in the milk samples collected at the same height in two different stables in the same valley are comparable. The value in pasture is the first experimental data

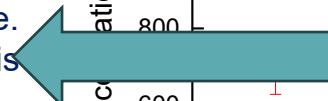

Concentrations Comparison in food samples

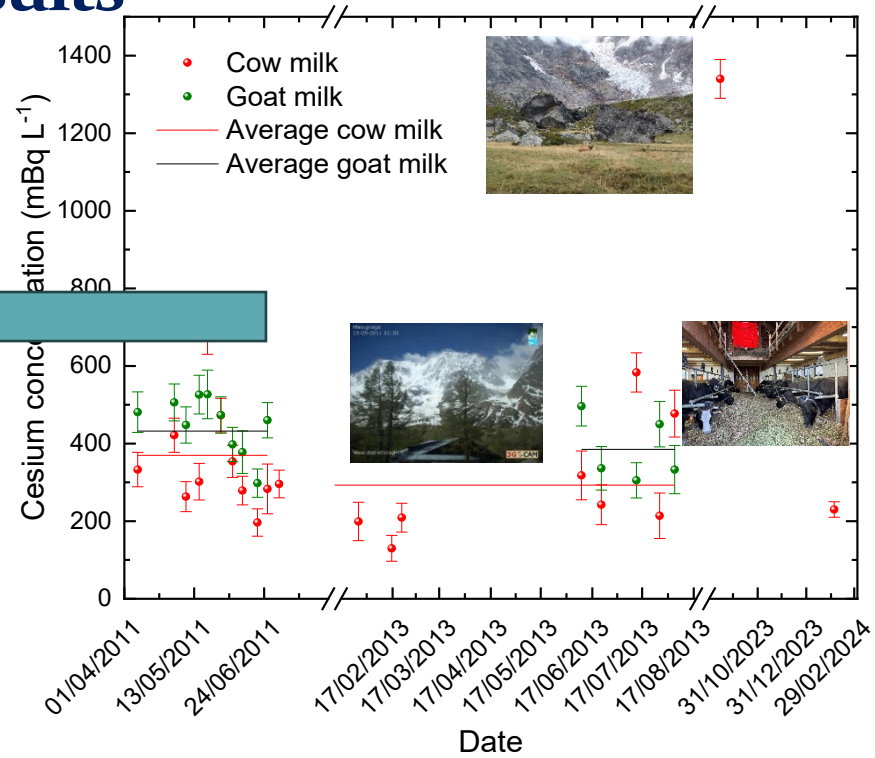
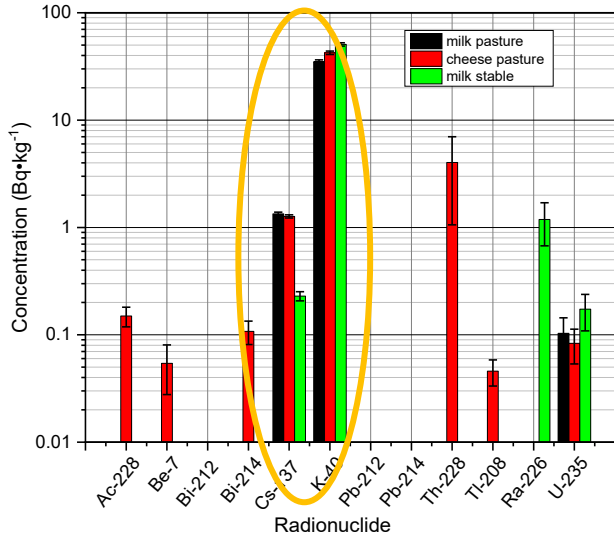

←—————→      ←—————→  
Ioannidou A. et al.      Conti E. et al.



# EyeRAD Project



Aluminum Outdoor Shelter

TSP High Volume Particulate Sampler designed and manufactured in full compliance with EPA requirements

- Project born from the awareness that the research activity within the INFN in the field of nuclear measurements is of the highest level and constitutes unique potential capable of offering a **service to society in environmental measurements**, in particular, in the **detection of artificial radioactivity issued following occasional anomalous events**, in parallel with the regional and national agencies and bodies that already deal with them for an institutional duty.

## Goal

- **environmental radioactivity monitoring network** focusing on measuring the concentration of radionuclides present in atmospheric particulate matter;
- inclusion of any other initiatives regarding **environmental monitoring and radiation protection**
- **Dissemination of these information to the population**

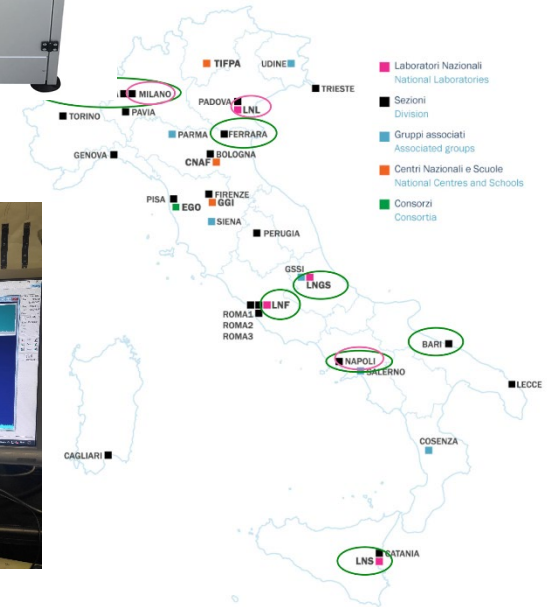
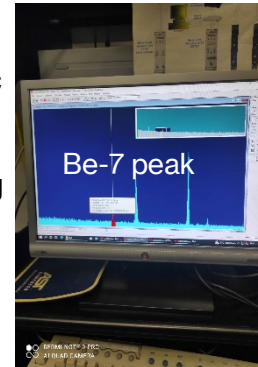

# Activity concentrations of $^{137}\text{Cs}$ in urine of children from Fukushima region - 2017

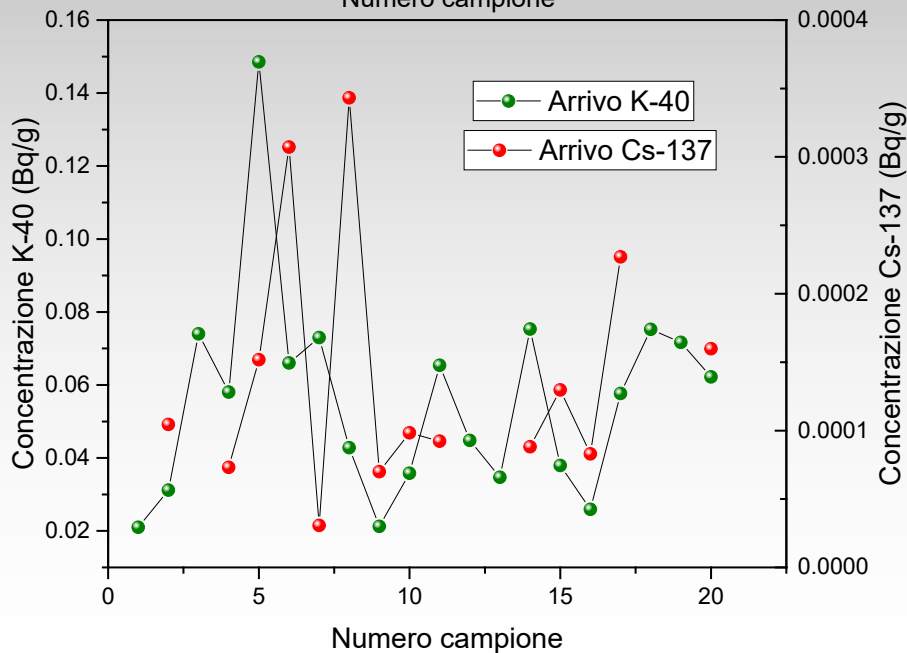
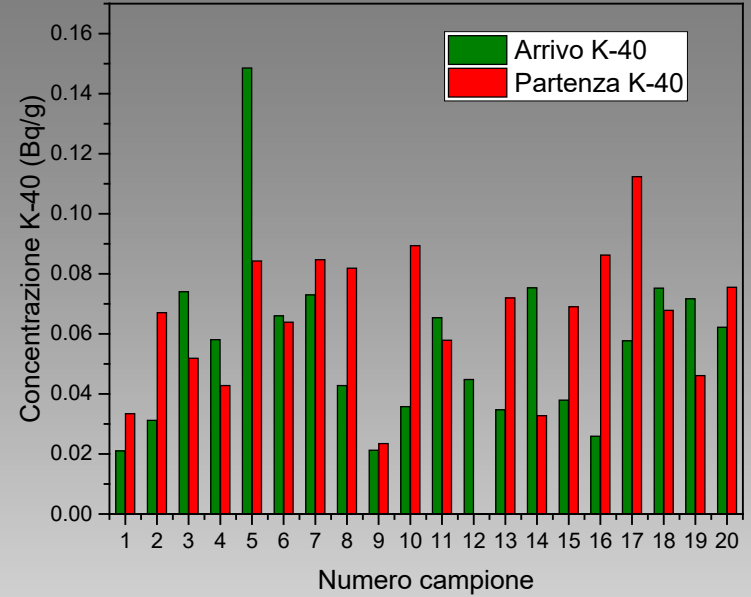
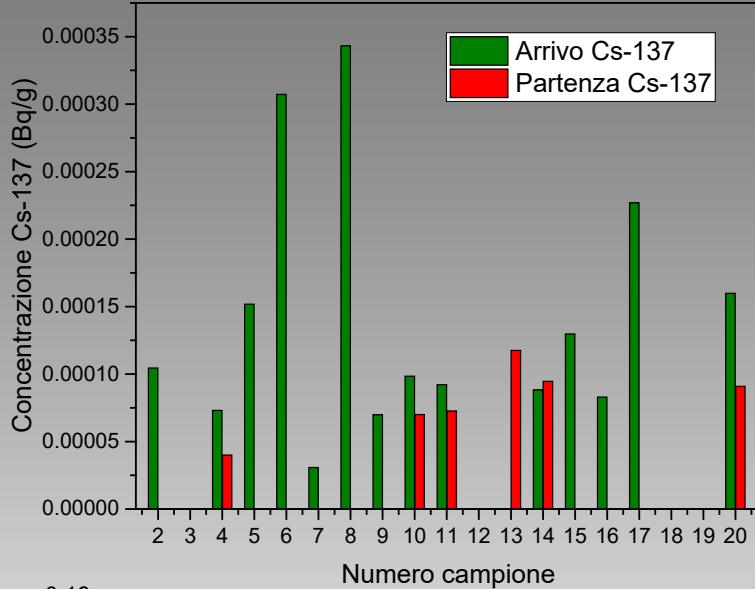

Nel grafico sono riportati i dati delle concentrazioni in arrivo del Cs-137 a confronto con i dati delle concentrazioni del K-40: sembra evidenziarsi la tendenza di una corrispondenza che vede che al valore più alto di concentrazione di Cs-137 corrisponda la concentrazione minore di K-40 e viceversa.

# CONCLUSIONS

- The Fukushima plume was detected in Milano, Italy and Thessaloniki, Greece, with the highest value concentration in surface air of  $467 \mu\text{Bq m}^{-3}$  almost in the same period on April 3-4, 2011
- The presence of more than one peaks of  $^{131}\text{I}$  and  $^{137,134}\text{Cs}$  is an index that air masses continuously transferred from Fukushima, Japan till the end of April, 2011.
- HYSPLIT backward trajectories interpreted the measured atmospheric concentrations
- The relative high concentrations of  $^{137}\text{Cs}$  in grass, soil and fresh milk samples, correspond to previous fallout rather than Fukushima accident
- $^{131}\text{I}$  and  $^{137,134}\text{Cs}$  isotopes were found above their detection limits in all environmental samples but very far below levels of concern

---



# Detecting and evaluating minimal traces of radioisotopes in environment and foods

---

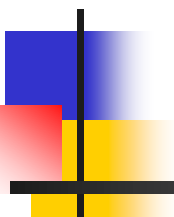

Paolo Randaccio



DSF (Dipartimento di Fisica – Università di Cagliari - Italy)  
INFN (Istituto Nazionale di Fisica Nucleare- Italy)



Paolo Randaccio NRC8 - Como  
18..21 September 2012



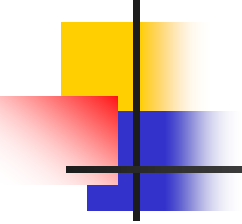

# Cs-137 & Cs-134 in urine of some japanese children

---

During the last August, 12 children from Japan have spent their holidays in Italy

When they arrived we collected their urine and we found traces of Cs-137 and Cs-134

We again collected the urine before they leave Italy

# The first measurement

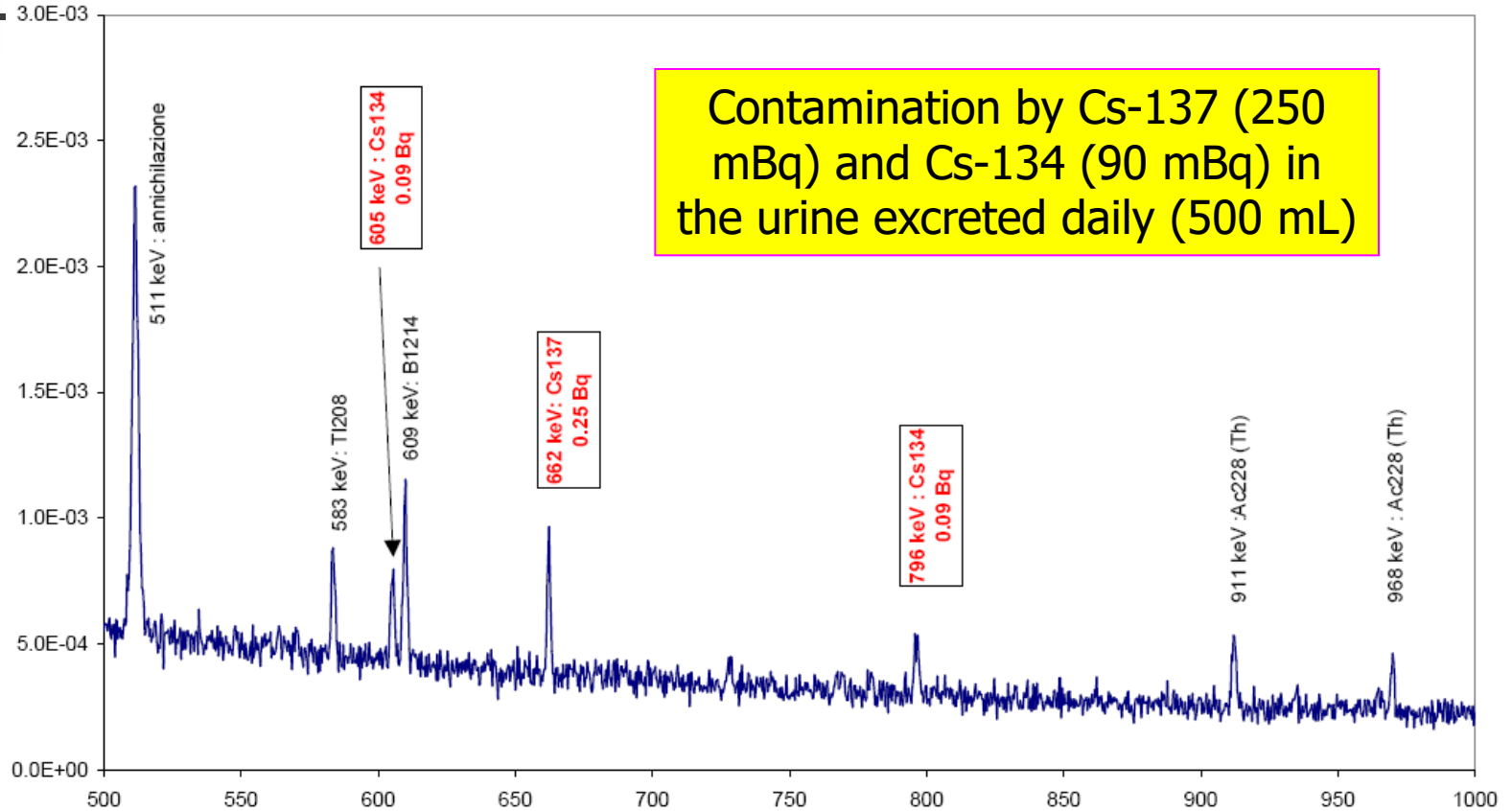

# Not only Cs-137 & Cs-134

Gamma Spectrum

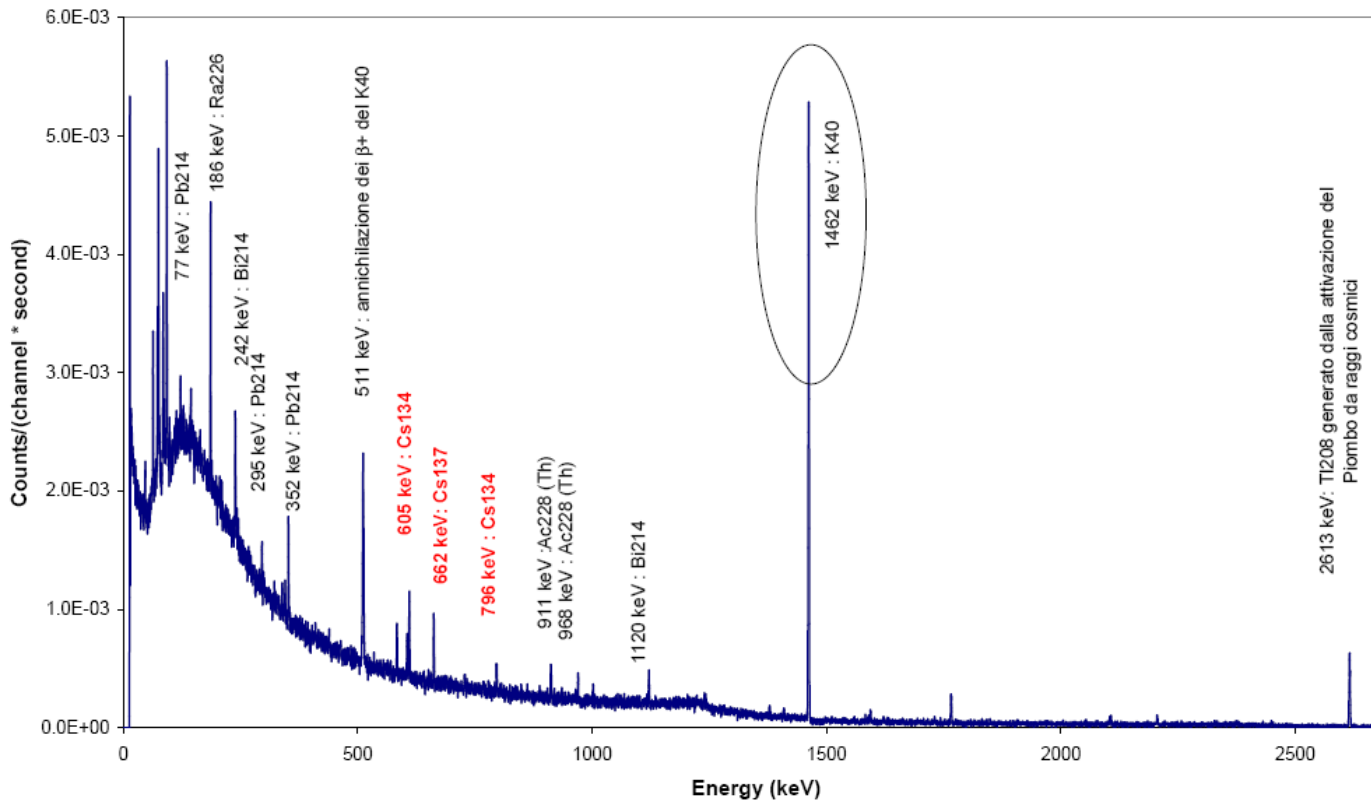

The contribution to the dose from the incorporated natural radionuclide K-40 is more important than Cs-137 & Cs-134

There are also the U & Th daughters

# The first hypothesis: acute contamination

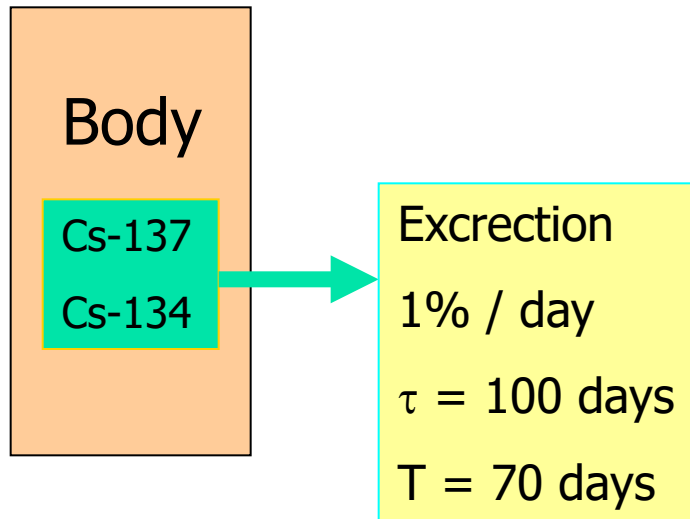

- We can assume that the cesium contamination occurred during the first days after the accident in Fukushima.
- Currently the cesium is eliminated slowly.
- The daily amount of cesium excreted in urine is approximately 1% of the total cesium incorporated.
- The biological mean-life time of cesium is about 100 days.



# We must consider the biological and radioactive decay

radioactive decay of Cs-137 and Cs-134

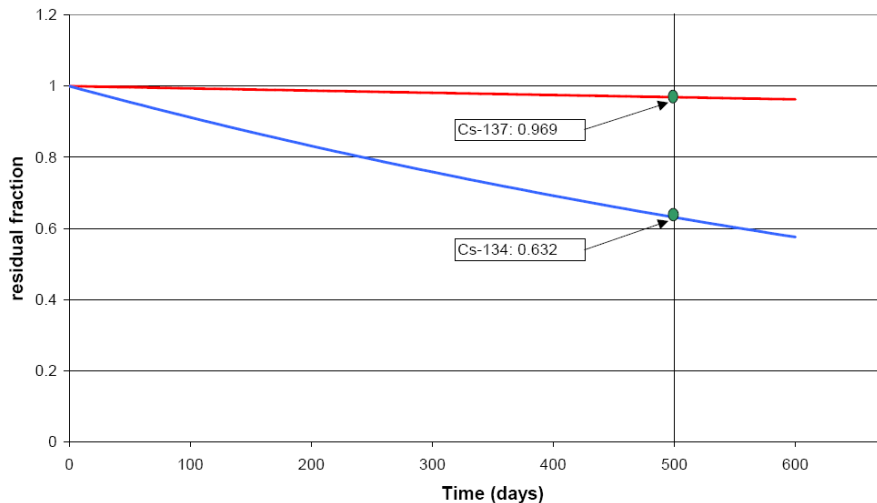

biological decay of Cesium

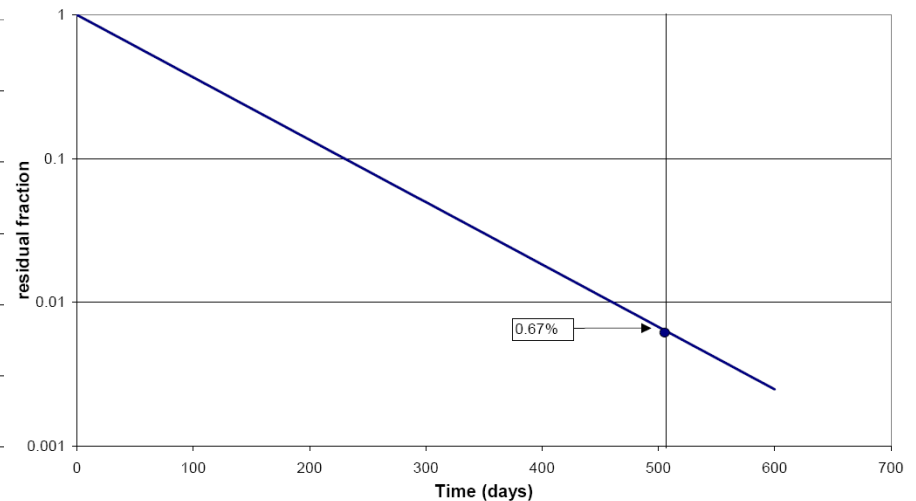

Based on the first hypothesis, the amount of cesium incorporated on August 1, 2012 was 25 Bq of Cs-137 and 9 Bq of Cs-134.

Taking into account the biological and radioactive decay, the activity initially was about 33 kBq of Cs-137 and 22 kBq of Cs-134.



# Wrong !

---

- This assumption has been proved false by the final measurement after 25 days

# The second measurement

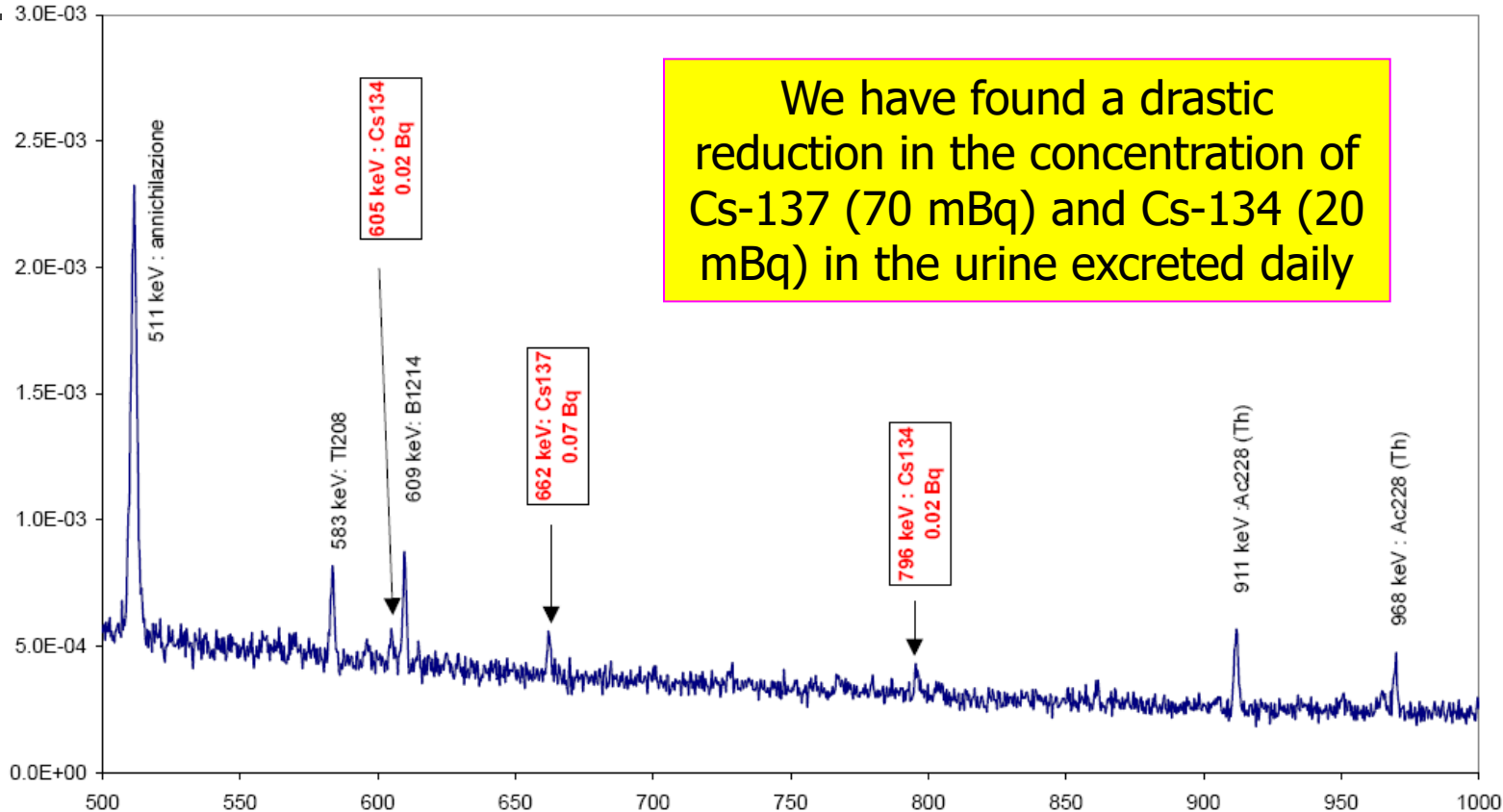

# It is a chronic contamination

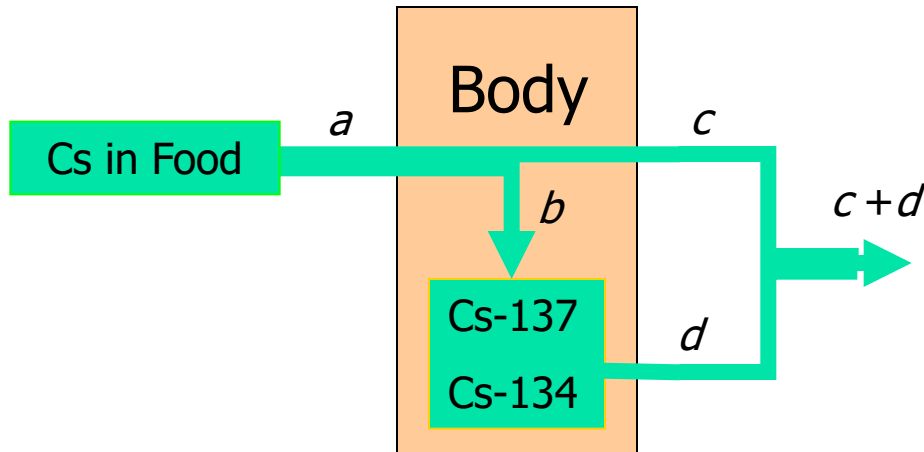

We measured  $c + d$  on the first day of arrival of the children, then we have an estimate of  $a$ , the amount of cesium taken daily with food.

- Cesium content in food ( $a$ ) is partly absorbed ( $b$ ) and partly excreted ( $c$ ) in the urine.
- Under equilibrium conditions the absorbed amount of cesium is constant.
- The amount of cesium excreted ( $c + d$ ) daily is equal to the amount of cesium taken ( $a$ ) daily with food.

# The balance has been modified

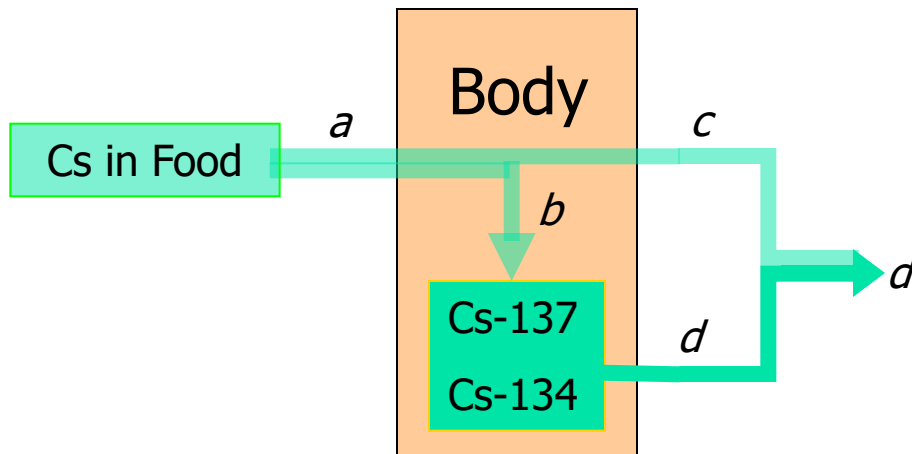

- The balance has been modified eating uncontaminated food for a month.
- The cesium found in urine corresponds to the fraction of incorporated cesium which is excreted daily.
- We measured the amount of cesium excreted ( $d$ ) daily in the last days of the holiday so we can evaluate the total amount of cesium incorporated.



# The cesium counter

---

- Cs-137 incorporated: 7 Bq
  - Cs-134 incorporated: 4 Bq
  - Cs-137 introduced daily with food: 0.25 Bq
  - Cs-134 introduced daily with food: 0.09 Bq
- 
- The activity of K-40 is much more, hundreds times greater ...

# Radioactivity in the food

Many foods are naturally radioactives.

The foods contribute for 10% to the total individual exposition to radioactivity, for about a total of 400  $\mu\text{Sv}$  per year.

Bananas are one of the more radioactive food because contain a lot of potassium and so also potassium-40 that is the radionuclide of K with an half-life of 1.277 bilions of years. The equivalent dose of ONE banana is about 1% of the dose that individually we receive from the natural environmental exposition.

It is introduced a new way to compute the dose:

***DOSE EQUIVALENT TO A BANANA***

***BED***

***THE RADIATION DOSE THAT WE RECEIVE EATING ONE BANANA***



# Radiation Dose Chart

This is a chart of the ionizing radiation dose a person can absorb from various sources. The unit for dose is "sievert" (Sv), and measures the effect a dose of radiation will have on the cells of the body. One sievert (all at once) will make you sick, and too many more will kill you, but we safely absorb small amounts of natural radiation daily. Note: The same number of sieverts absorbed in a shorter time will generally cause more damage, but your cumulative long-term dose plays a big role in things like cancer risk.

**Banana  
Equivalent  
Dose  
BED**

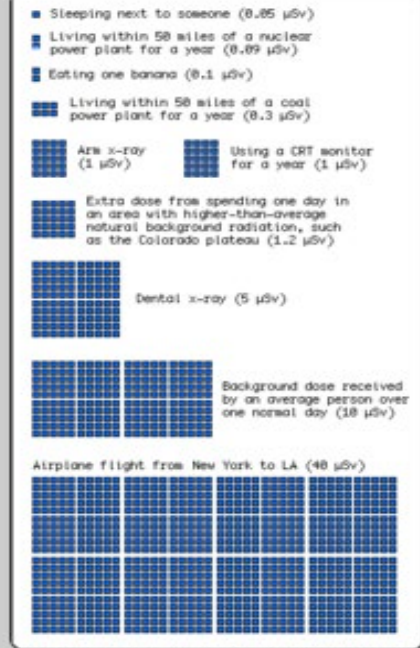

Using a cell phone (0 µSv)—a cell phone's transmitter does not produce ionizing radiation\* and does not cause cancer.  
\* Unless it's a banana phone.

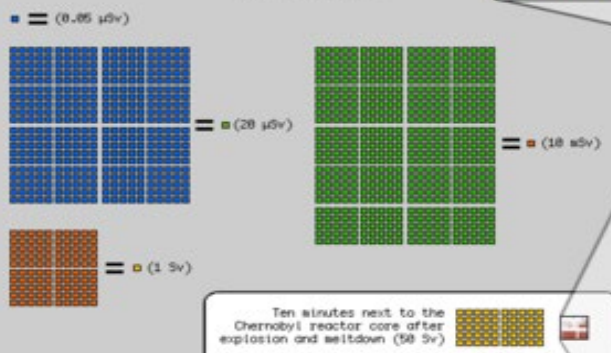

Sources:

- <http://www.nrc.gov/radiation/rad-dose-collections/uv-part002/>
- [www.nrc.gov/technological/dose-calcs.html](http://www.nrc.gov/technological/dose-calcs.html)
- [http://www.dhs.gov/xlibrary/assets/radiation/dose\\_calculator.xls](http://www.dhs.gov/xlibrary/assets/radiation/dose_calculator.xls)
- [http://www.dhs.gov/xlibrary/assets/radiation/radiation\\_guide.xls](http://www.dhs.gov/xlibrary/assets/radiation/radiation_guide.xls)
- <http://www.iaea.org/>
- <http://www.epa.gov/rse/rse-006-00200-00200-01.pdf>
- <http://www-nsd.nsl.edu/~nsd/npw/bvns/rrn/rrn.html.pdf>
- <http://people.reed.edu/~eevason/radiation.html>
- <http://en.wikipedia.org/wiki/Sievert>
- <http://blog.vonsoestri.com/2010/07/18/into-the-zone-chenobyl-prigovet/>
- <http://www.nrc.gov/radiation/rad-dose-collections/rad-dose-calculator/uv-dose-radiation-uv.html>
- [http://www.nrc.gov/xpress/c2/c2main/other/detec/detec/c2detec/c2detec/2010/03/16/000727\\_076.pdf](http://www.nrc.gov/xpress/c2/c2main/other/detec/detec/c2detec/c2detec/2010/03/16/000727_076.pdf)
- <http://radiology.rmc.org/content/263/1/234>

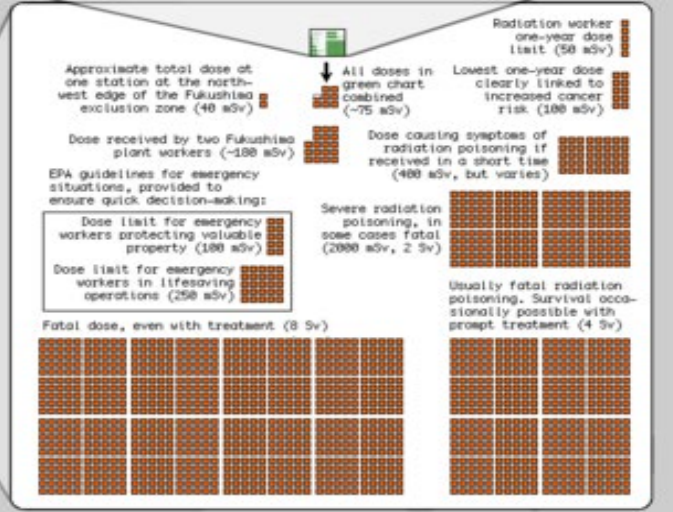
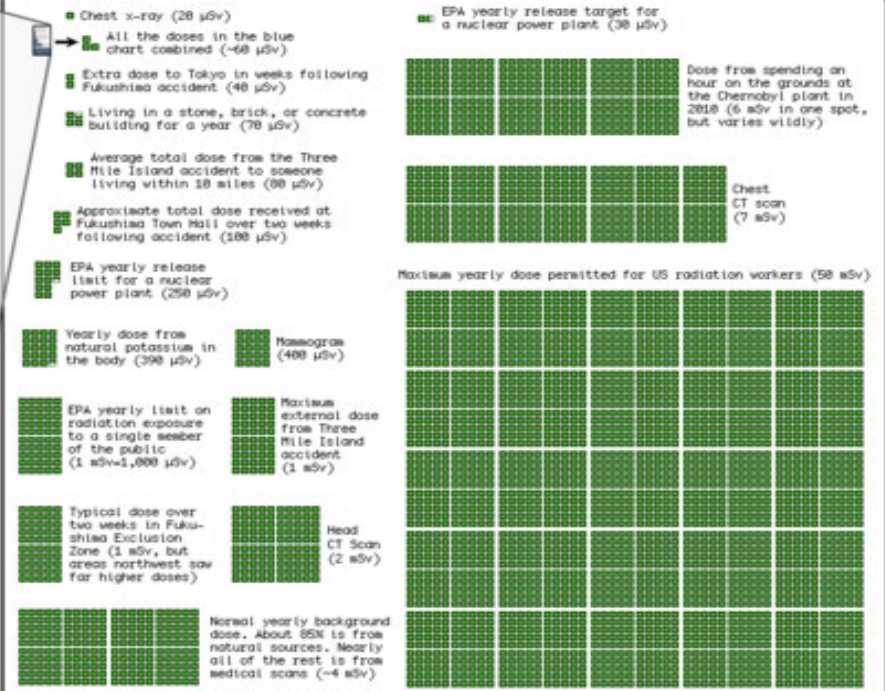



# Radioactivity in the food

**0,1  $\mu\text{Sv}$**  is the radiation dose for a banana of **150 g**  
as a comparison

the natural daily dose is equivalent to **100 BED**,

the absorbed dose sleeping near another person is **0,5 BED**

the absorbed dose from a person at a distance of 16 km during the [Three Mile Island](#) is **700 BED**

the maximum allowed emission from a thermonuclear plant is **2 500 BED**,

the absorbed dose during a lung radiography is around **70 000 BED**

a letal dose of radiation is about **80 billion of BED**

# Radioactivity in the food

**0,1  $\mu\text{Sv}$**  is the radiation dose for a banana of **150 g**

To reach the maximum dose allowed for Italian Radioprotection Law for the public that is equal to **1 mSv/a** the adults have to eat about **20.000** bananas per year.

**BUT**

The radiation dose in the human body related to eat the bananas is NOT cumulative in the sense that the potassium follows the **homeostatic law** and is kept at a constant value: the exceeded amount is discharged by the kidney.

Some foods rich in potassium are: **potatoes, beans, sun flower seeds and some kind of dry fruit**. Some other foods like the **nut of Brasil** (*Bertholletia excelsa*), are rich not only of potassium but also of **radium**, that is accumulated in the bones due to its chemical affinity with calcium.

# Comparison between different kind of exposition to ionizing radiation

The medium exposition in the 10 years after Chernobyl for Italian population is about 0,7 mSv and can be expressed like to eat 11,5 bananas per day.

The risk to die for a cancer developed to exposition to ionizing radiation is **100  $\mu$ Sv (= three bananas per day for one year) and this increase the dead risk of 1 milion,**

The same risk is obtained with some activity of daily activities like:

- Drive a car for 65 km,
- Flight for 4 000 km,
- Eat 40 spoon of peanut butter
- Smoke 1,4 sigaretttes
- Play canoeing for 6 minutes
- Stay for 2 days in [New York](#) (exposed to urban pollution)

# LE SORGENTI NATURALI DI RADIAZIONI IONIZZANTI

Com'è noto, la radioattività è una normale componente dell'ambiente naturale. L'uomo è stato costantemente esposto alle radiazioni di origine naturale fin dal suo apparire sulla terra e queste sono rimaste l'unica fonte di irradiazione fino a poco meno di un secolo fa. Ancora adesso, malgrado il largo impiego di sostanze radioattive artificiali e di impianti radiogeni di vario genere, la radioattività naturale continua a fornire il maggior contributo alla dose ricevuta dalla popolazione mondiale ed è assai improbabile che ciò non continui a verificarsi anche in futuro.

Nella radioattività naturale si distinguono:

Componente  
terrestre:



radionuclidi cosiddetti primordiali presenti in varie quantità nei materiali inorganici della crosta terrestre (rocce, minerali) fin dalla sua formazione.

Componente  
extra-terrestre



- raggi cosmici
- radionuclidi cosmogenici.

**Quando ci si riferisce a tutte queste sorgenti si parla di  
fondo naturale di radiazioni.**

# RAGGI COSMICI

I raggi cosmici provengono, per la maggior parte, dal profondo spazio interstellare e sono costituiti principalmente da **particelle cariche positivamente: protoni (85%), alfa (14%) e nuclei pesanti, con energie di parecchi MeV**, che quando giungono in prossimità della terra, risentono dell'azione derivante dal campo magnetico terrestre.

I flussi sono modulati dal vento solare e dai campi magnetici interplanetari.

C'è anche una componente solare che trae origine dalle esplosioni nucleari sul sole e consiste ancora di protoni e particelle cariche positive.

I raggi cosmici sono in gran parte intrappolati nel campo magnetico terrestre in due zone:

- **prima: a circa 1 RAGGIO terrestre dalla superficie, è popolata principalmente da protoni con energie di qualche centinaio di MeV;**
- **seconda: più esterna a 4 RAGGI terrestri, è popolata principalmente da elettroni con energia media di circa 7 MeV.**

# RAGGI COSMICI

L'interazione di queste particelle di alta energia – raggi cosmici primari – con l'atmosfera terrestre comporta l'emissione di numerosi prodotti secondari, quali ad esempio mesoni (particelle di massa compresa tra l'elettrone ed il protone), elettroni, fotoni, protoni e neutroni che a loro volta possono creare altre particelle secondarie.

**Per la maggior parte i raggi cosmici primari vengono assorbiti nello strato più alto dell'atmosfera e sulla terra i raggi cosmici secondari.**

**Quindi, parte della radiazione cosmica giunge sino a terra, generando nell'interazione con l'atmosfera cascate elettro – fotoniche.**

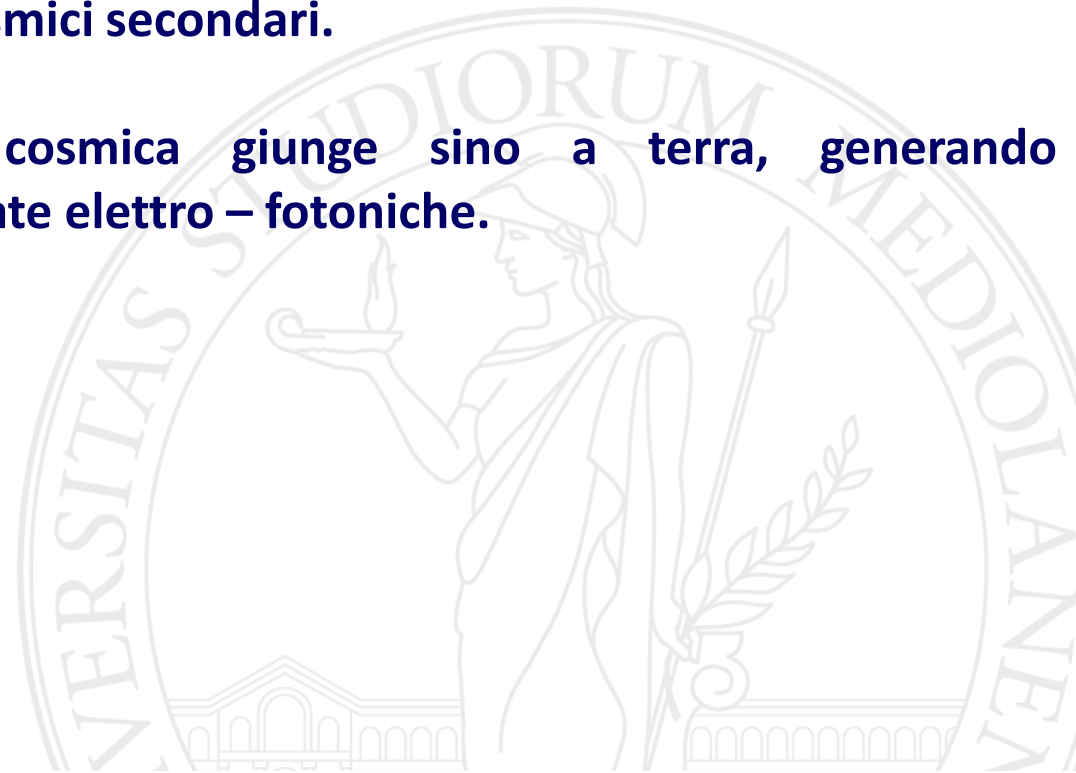

# RAGGI COSMICI

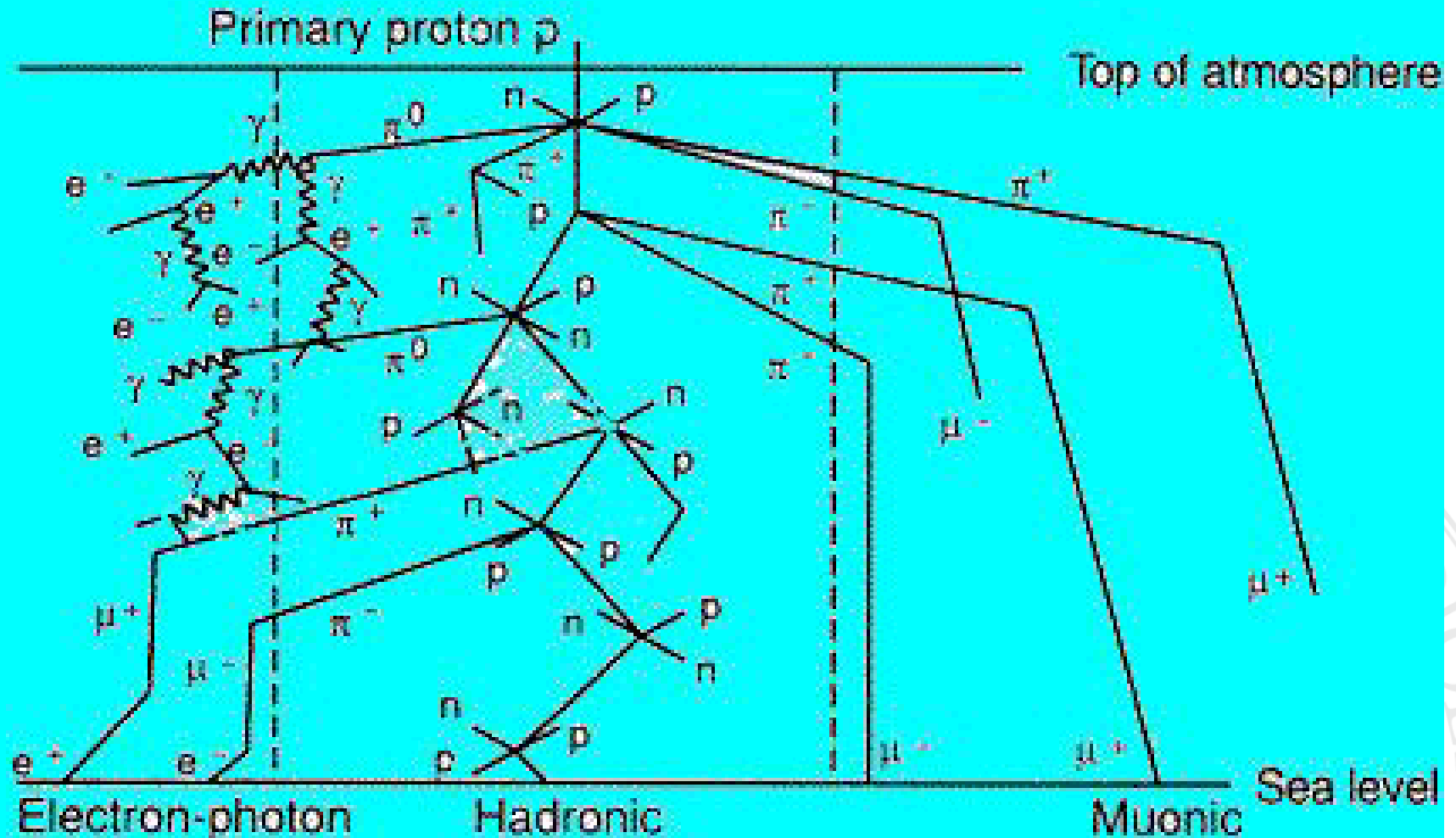

Rappresentazione schematica della produzione di particelle in atmosfera

# RAGGI COSMICI

Ai poli il contributo di dose dovuto ai raggi cosmici è maggiore rispetto alle zone equatoriali, per effetto dell'azione del campo magnetico terrestre.

Il livello di dose dovuta ai raggi cosmici livello di dose aumenta con l'altitudine, con il ridursi dello spessore d'aria che fa da schermo:

- a livello del mare è di circa  $0.4 \text{ mSv a}^{-1}$ ; raddoppia ogni circa 1500 metri;
- a 10 km di altitudine, l'esposizione alla radiazione cosmica è quasi 100 volte più elevata di quella a livello del mare.

L'atmosfera produce infatti al livello del mare una protezione equivalente a quella di uno schermo di calcestruzzo di circa 4 m di spessore, mentre alla quota di 10000 m l'effetto di schermaggio si riduce a circa 1 m.

**L'esposizione alla radiazione cosmica è di notevole interesse per gli equipaggi degli aerei destinati ai voli intercontinentali.**

**Per i piloti e assistenti di volo questi livelli, dell'ordine di  $5 \text{ mSv h}^{-1}$  costituiscono un problema reale, soprattutto se effettuano voli con rotte polari.**



# RAGGI COSMICI



livello di dose aumenta con l'altitudine, con il ridursi dello spessore d'aria che fa da schermo:

a livello del mare **è di circa 0.4 mSv a<sup>-1</sup>; raddoppia ogni circa 1500 metri.**

# RAGGI COSMICI

Figure IV. Components of the dose equivalent rate due to cosmic rays in the atmosphere [U3]

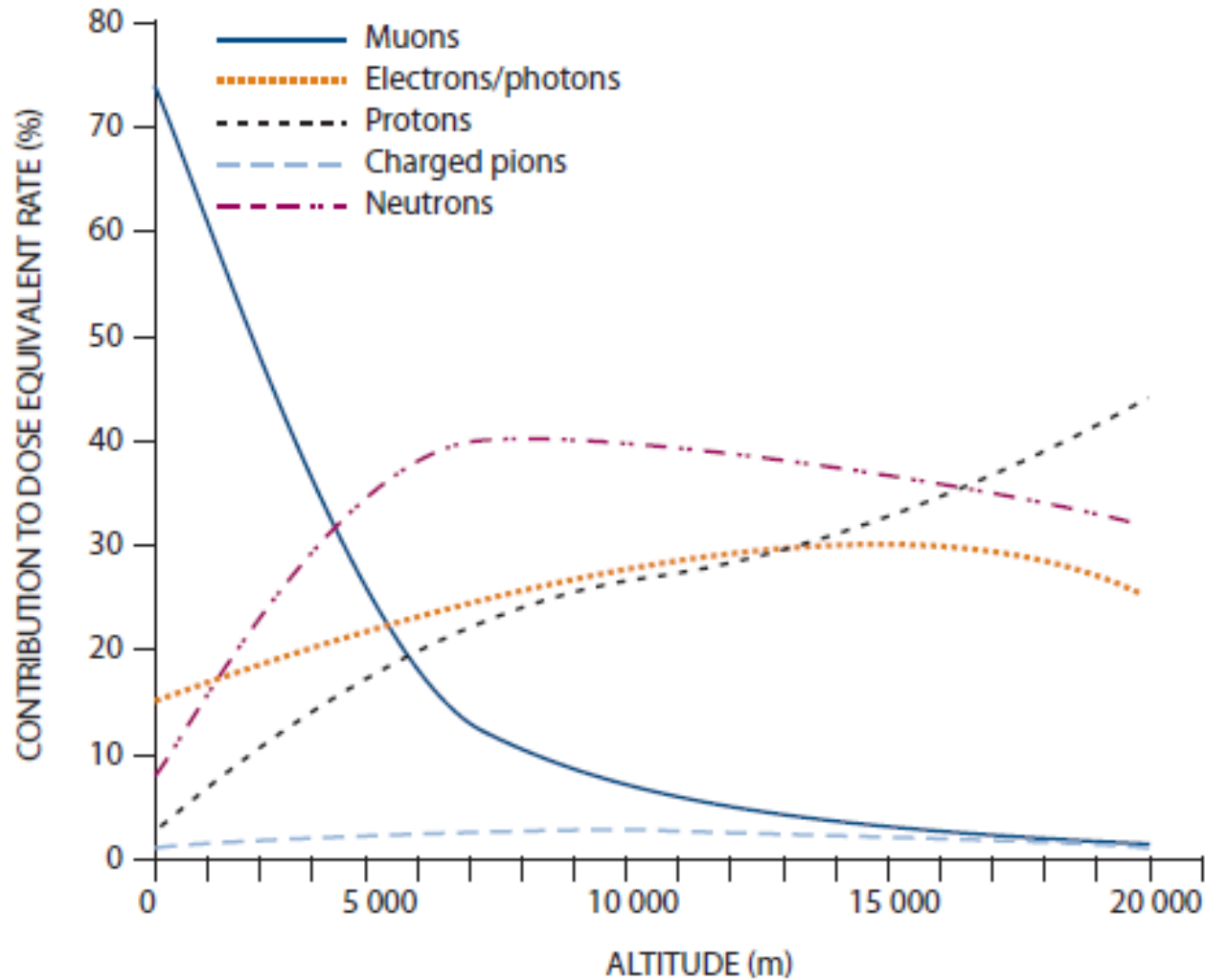

# RAGGI COSMICI

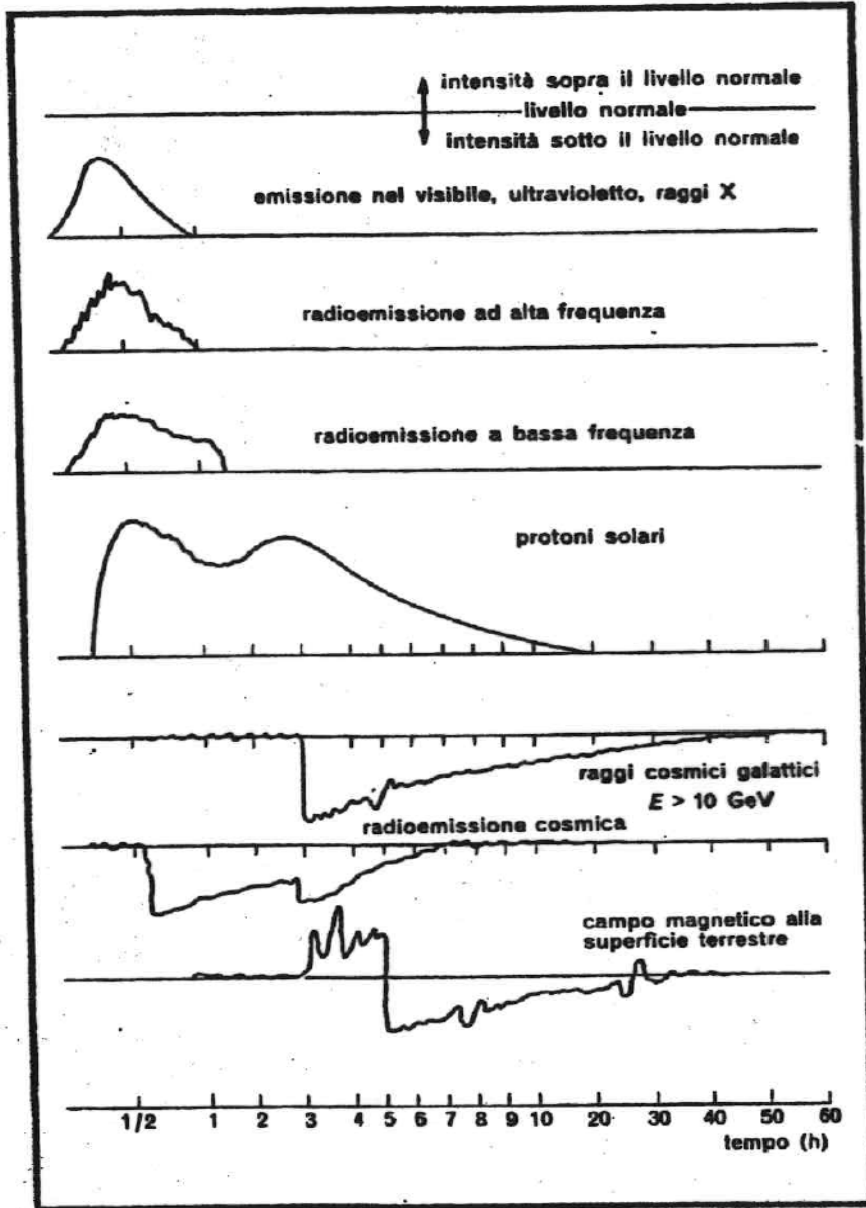

**Fig.7** I diversi effetti prodotti sulla radiazione cosmica e registrati durante un medesimo brillamento solare. Le linee orizzontali stanno a indicare il livello normale della radiazione stessa.

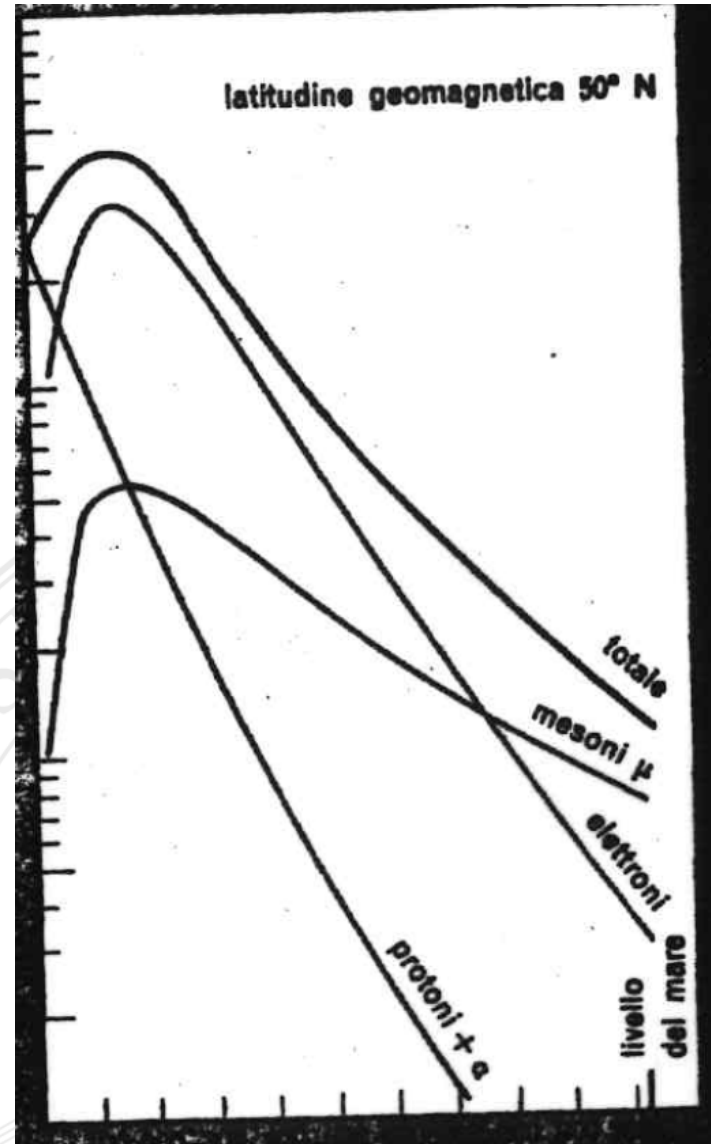

Sviluppo nell'atmosfera della componente secondaria carica

# RAGGI COSMICI

Figure I. Variation in solar activity in terms of the historical monthly average sunspot numbers during solar cycles [N4]

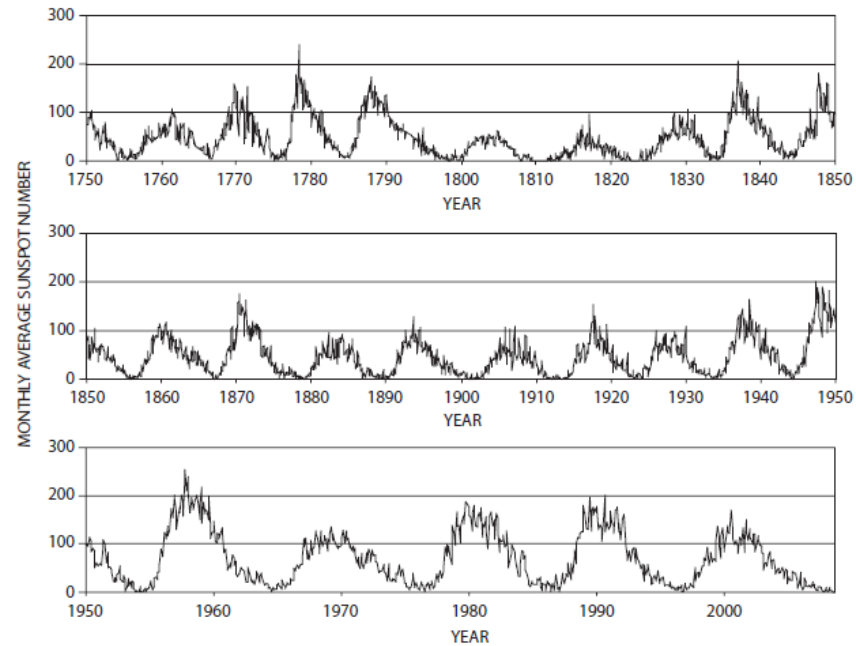
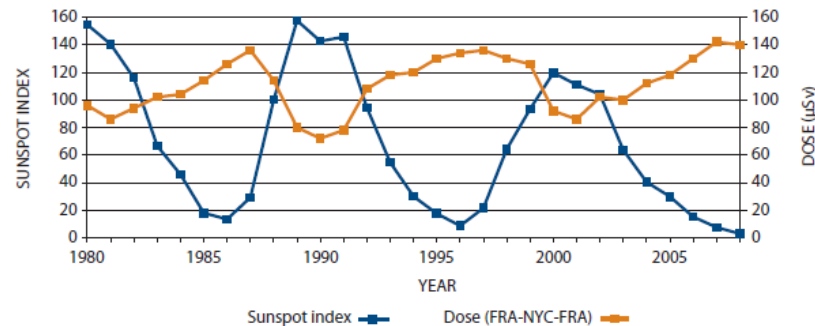

Figure II. Example of the influence of variation in solar activity on cosmic ray dose received during a return transcontinental flight between Frankfurt and New York City [S38]



# RAGGI COSMICI

Route	Subsonic flight at 36,000 ft (11 km)			Supersonic flight at 62,000 ft (19 km)		
	Flight duration (hrs)	Dose per round trip		Flight duration (hrs)	Dose per round trip	
		(mrad)	( $\mu$ Gy)		(mrad)	( $\mu$ Gy)
<b>Los Angeles - Paris</b>	11.1	4.8	48	3.8	3.7	37
<b>Chicago - Paris</b>	8.3	3.6	36	2.8	2.6	26
<b>New York - Paris</b>	7.4	3.1	31	2.6	2.4	24
<b>New York - London</b>	7.0	2.9	29	2.4	2.2	22
<b>Los Angeles - New York</b>	5.2	1.9	19	1.9	1.3	13
<b>Sydney - Acapulco</b>	17.4	4.4	44	6.2	2.1	21

# RADIONUCLIDI COSMOGENICI

Sono prodotti principalmente dalla interazione dei raggi cosmici con i nuclei presenti nell'atmosfera.

Si formano prevalentemente per l'interazione di neutroni. Ad esempio:

C-12 (n,2n) C-11

C-12 (n,2n  $\alpha$ ) Be-7 ;

N-14 (n,p) C-14

## Dati relativi ad alcuni radionuclidi cosmogenici (dati UNSCEAR 82)

Radionuclide	Tempo di dimezzamento	Numero totale di atomi prodotti nell'atmosfera per unità di tempo e di superficie terrestre ( $m^{-2} s^{-1}$ )	Inventario globale (PBq)	Attività per unità di volume di aria ( $\mu Bq m^{-3}$ )	Attività per unità di volume nelle acque della superficie continentale ( $Bq m^{-3}$ )	Attività specifica nella biosfera terrestre ( $Bq kg^{-1}$ )
H-3	12.3 a	2500	1300		200 ÷ 900	
Be-7	53.6 g	810	37	3000		
C-14	5730 a	16000 ÷ 25000	8500			230
Na-22	2.62 a	0.86	0.4	0.3		

# RADIONUCLIDI PRODOTTI IN ATMOSFERA DALLA RADIAZIONE COSMICA (MOE)

$^3\text{H}$	12.5 a	$\beta$ 18 keV	spallazione di C, O, N e Ar <sup>I</sup>	$(0,25 \pm 0,05)$	3,5 kg
$^7\text{Be}$	53 d	$\gamma$ 48 keV	spallazione di C, O, N e Ar <sup>I</sup>	$(8,2 \times 10^{-2})$	3.2 g
$^{10}\text{Be}$	$2,7 \cdot 10^6$ a	$\beta$ 550 keV	spallazione di C, O, N e Ar <sup>I</sup>	$5 \times 10^{-2}$	450 t
$^{14}\text{C}$	5570 a	$\beta^-$ 156 keV	spallazione $^{14}\text{N}$ (n,p), $^{14}\text{C}$	1.8	54 t
$^{22}\text{Na}$	2.6 a	$\left\{ \begin{array}{l} \beta^+ 540 \text{ keV} \\ \gamma 1,3 \text{ MeV} \end{array} \right.$	spallazione argo	$5,6 \times 10^{-5}$	1.2 kg
$^{32}\text{P}$	14.3 d	$\beta^-$ 1.7 MeV	spallazione argo	$8,1 \times 10^{-4}$	0.4 g
$^{33}\text{P}$	25 d	$\beta^-$ 250 keV	spallazione argo	$6,8 \times 10^{-4}$	0.6 g
$^{32}\text{Si}$	710 a	$\beta^-$ 100 keV	spallazione argo	$1,6 \times 10^{-4}$	1.4 kg
$^{35}\text{S}$	87 d	$\beta^-$ 167 keV	spallazione argo	$1,4 \times 10^{-3}$	4.5 g
$^{36}\text{Cl}$	$3,1 \cdot 10^5$	$\beta^-$ 714 keV	$\left\{ \begin{array}{l} \text{spallazione argo;} \\ \text{cattura n da } ^{35}\text{Cl} \\ \text{sulla Terra} \end{array} \right.$	$1,1 \times 10^{-3}$	15 t <sup>2</sup>
$^{39}\text{Cl}$	55 min	$\beta^-$ 1.5 MeV	spallazione argo $^{40}\text{Ar}$ ( $\mu^-, n$ ), $^{39}\text{Cl}$	$1,6 \times 10^{-2}$	2.5 mg



# RADIONUCLIDI PRIMORDIALI

I principali radionuclidi primordiali sono quelli riportati in tabella e le famiglie radioattive naturali dell'uranio, del torio e dell'attinio.

Radionuclide	$T_{1/2}$ (anni)	Principali radiazioni emesse
<b>K-40</b>	$1.3 \cdot 10^9$	$\beta, \gamma$
<b>Rb-87</b>	$5 \cdot 10^{10}$	$\beta$
<b>La-138</b>	$1.1 \cdot 10^{11}$	$\beta, \gamma$
<b>Sm-147</b>	$1.3 \cdot 10^{11}$	$\alpha$
<b>Lu-176</b>	$3 \cdot 10^{10}$	$\beta, \gamma$
<b>Re-187</b>	$5 \cdot 10^{10}$	$\beta$

La radioattività naturale fornisce il maggior contributo alla dose collettiva ricevuta dalla popolazione mondiale.

Da questo punto di vista i radionuclidi più importanti sono quelli appartenenti alle famiglie **dell'uranio, del torio e il K-40**.



# RADIONUCLIDI PRIMORDIALI

## RADIONUCLIDI NATURALI

isotopo	abbondanza (%)	t dimezzamento (y)	transizioni
$^{40}_{19}\text{K}$	0.0119	$1.2 \cdot 10^9$	$\beta^-$ , EC, $\gamma$
$^{87}_{37}\text{Rb}$	27.85	$6 \cdot 10^{10}$	$\beta^-$
$^{115}_{49}\text{In}$	95.77	$6 \cdot 10^{14}$	$\beta^-$
$^{130}_{52}\text{Te}$	34.49	$1 \cdot 10^{21}$	produzione di $^{130}_{54}\text{Xe}$
$^{138}_{57}\text{La}$	0.089	$2 \cdot 10^{11}$	$\beta^-$ , EC
$^{144}_{60}\text{Nd}$	23.9	$1 \cdot 10^{15}$	$\alpha$
$^{147}_{62}\text{Sm}$	15.07	$1.4 \cdot 10^{11}$	$\alpha$
$^{176}_{71}\text{Lu}$	2.6	$7.5 \cdot 10^{10}$	$\beta^-$ , $\gamma$
$^{187}_{75}\text{Re}$	62.93	$4 \cdot 10^{12}$	$\beta^-$
$^{232}_{90}\text{Th}$	100	$1.4 \cdot 10^{10}$	$\alpha$
$^{235}_{92}\text{U}$	0.715	$7.1 \cdot 10^8$	$\alpha$
$^{238}_{92}\text{U}$	99.28	$4.5 \cdot 10^9$	$\alpha$