



Istituto Nazionale di Fisica Nucleare
Laboratori Nazionali di Frascati

DAΦNE: the circular *Crab-Waist* Collider



Catia Milardi

Scientific Head of the DAΦNE Accelerator Complex

Frascati, April 2023

Particle Accelerator Physics

Particle Accelerators

ATOMI

MATERIA animata ed inerte

Strumenti per:
 Diagnostica Medica
 Terapia Oncologica

Produzione di
 componenti avanzate
 per l'elettronica

Presently in the world
 there are **30000** operating
 particle accelerators

ATOMI variamente organizzati

Proprietà atomiche e molecolari
 Studio delle strutture cristalline

	1 st	2 nd	3 rd					
QUARKS	u up 2.3 M 2/3 1/2	c charm 1.27 G 2/3 1/2	t top 173.1 G 2/3 1/2	strong nuclear force	H higgs 126 G 0 0			
	d down 4.8 M -1/3 1/2	s strange 95 M -1/3 1/2	b bottom 4.2 G -1/3 1/2					
						g gluon 0 0 1		
						electromagnetic force		
							weak nuclear force	
LEPTONS	e electron 0.511 M -1 1/2	μ muon 105.7 M -1 1/2	τ tau 1.78 G -1 1/2	W W boson 80.4 G -1 1	Z Z boson 91.2 G 0 1			
	ν_e e neutrino 0 -22 1/2	ν_μ μ neutrino 0 0.17 M 1/2	ν_τ τ neutrino 0 1.55 M 1/2					
						W W boson 80.4 G -1 1	Z Z boson 91.2 G 0 1	
								GAUGE BOSONS
						FERMIONS		

NUCLEO

NUCLEONE

quark

Struttura del nucleo
 Studio delle particelle elementari

Topics

- *Transverse beam dynamics*
- *Longitudinal beam dynamics*

Particle motion in a uniform magnetic field

A uniform magnetic field \mathbf{B} can be used to maintain a particle on a circular orbit

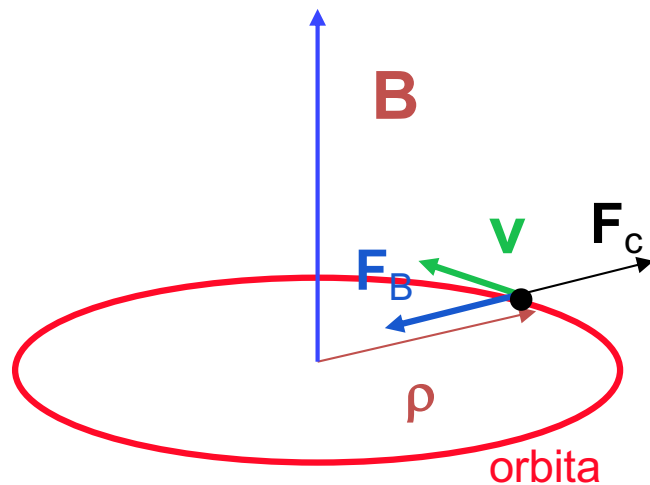

- charge q

$$F_c = \frac{mv^2}{\rho}$$

centrifugal force

$$F_B = q\mathbf{v} \times \mathbf{B}$$

Lorentz force

$$qvB = \frac{mv^2}{\rho}$$

equilibrium condition

$$\rho = \frac{mv}{qB} = \frac{p}{qB}$$

bending radius

$$\rho[m]B[T] = \frac{p}{q}$$

magnetic rigidity

Transverse Dynamics of a Particle in a Storage Ring

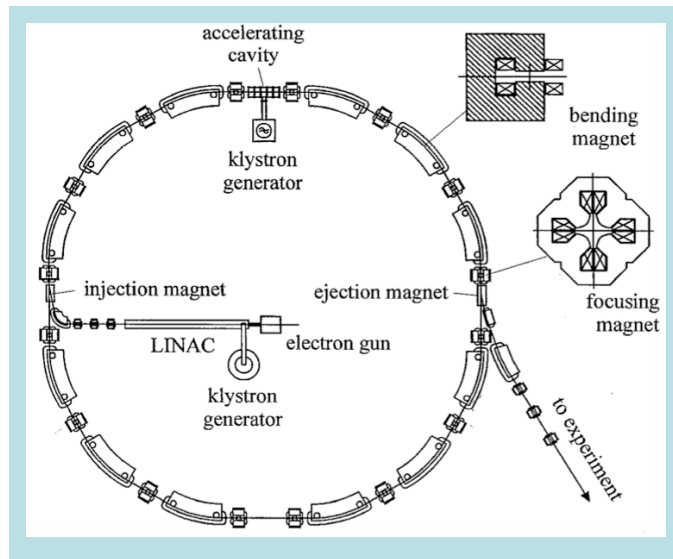

Reference System (x,y,s)

$$x' = \frac{\Delta x}{\Delta s}$$

$$y' = \frac{\Delta y}{\Delta s}$$

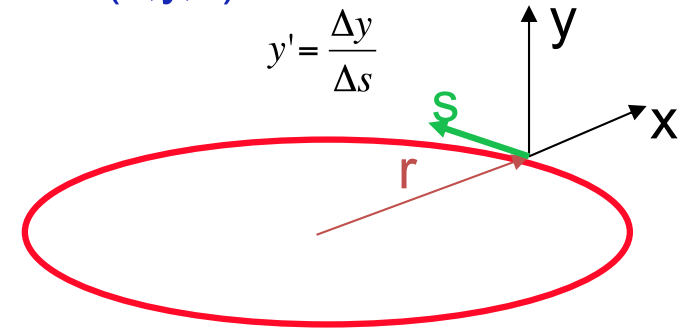

the nominal orbit corresponds to the design energy E_0

Main concepts:

nominal orbit

revolution period T

revolution frequency f_r

$$T = \frac{2\pi r}{v} \quad f_r = \frac{1}{T} = \frac{v}{2\pi r}$$

A particle injected on the nominal orbit with initial conditions:

$$x_0 = 0 \quad x'_0 = 0 \quad y_0 = 0 \quad y'_0 = 0 \quad E = E_0$$

stays on the nominal orbit ideal particle

As soon as one of the parameters: x_0 , x'_0 , y_0 , y'_0 , E is different from zero the particle starts to oscillate

Linear Beam Optics

Assumptions

Cartesian coordinate system whose origin moves along the beam orbit $\rightarrow K \equiv (x, z, s)$

Particles move mainly along s direction $\rightarrow v \equiv (0, 0, v_s)$

Magnetic field only has transverse components $\rightarrow B \equiv (B_x, B_z, 0)$

Magnetic field is constant with time and is symmetric w.r.t. the orbit plane

Equilibrium condition between Lorentz and centrifugal forces:

$$\frac{1}{R(x, z, s)} = \frac{e}{p} B(x, z, s)$$

Magnetic field can be expanded around the nominal trajectory since transverse beam dimension are small w.r.t R and multiplying by e/p

$$\begin{aligned} \frac{e}{p} B_z(x) &= \frac{e}{p} B_{z0} + \frac{e}{p} \frac{dB_z}{dx} x + \frac{1}{2!} \frac{e}{p} \frac{d^2 B_z}{dx^2} x^2 + \frac{1}{3!} \frac{e}{p} \frac{d^3 B_z}{dx^3} x^3 + \dots \\ &= \frac{1}{R} + kx + \frac{1}{2!} mx^2 + \frac{1}{3!} ox^3 + \dots \end{aligned}$$

Linear Beam Optics as far as the first two terms are taken into account

Linear Beam Optics

Assumptions:

Cartesian coordinate system whose origin moves along the beam orbit $\rightarrow K \equiv (x, z, s)$

Particles move mainly along s direction $\rightarrow v \equiv (0, 0, v_s)$

Magnetic field only has transverse components $\rightarrow B \equiv (B_x, B_z, 0)$

Magnetic field is constant with time and is symmetric w.r.t. orbit plane i.e. $B(z) = B(-z)$

Equilibrium condition between Lorentz and centrifugal forces:

K rotates when the beam is steered and the unit vector \mathbf{x}_0 and \mathbf{s}_0 transform as:

$$\mathbf{x}_0 = \mathbf{x}_{0a} \cos \varphi + \mathbf{s}_{0a} \sin \varphi$$

$$\mathbf{s}_0 = -\mathbf{x}_{0a} \sin \varphi + \mathbf{s}_{0a} \cos \varphi$$

unit vector derivatives

$$\frac{ds_0}{d\varphi} = -x_0 \quad \frac{dx_0}{d\varphi} = s_0$$

$$ds = R d\varphi \quad \frac{d\varphi}{dt} = \frac{1}{R} \frac{d\varphi}{dt}$$

unit vector time derivatives

$$\dot{\mathbf{x}}_0 = \frac{dx_0}{d\varphi} \frac{d\varphi}{dt} = \frac{1}{R} \dot{\mathbf{s}}_0$$

$$\dot{\mathbf{s}}_0 = \frac{ds_0}{d\varphi} \frac{d\varphi}{dt} = -\frac{1}{R} \dot{\mathbf{x}}_0 \quad \dot{z}_0 = 0$$

K origin moves as

$$d\mathbf{r}_0 = \mathbf{s}_0 ds \quad \dot{\mathbf{r}}_0 = \dot{\mathbf{s}}_0 s$$

General expression for the particle position on the trajectory

$$\mathbf{r} = \mathbf{r}_0 + x\mathbf{x}_0 + z\mathbf{z}_0$$

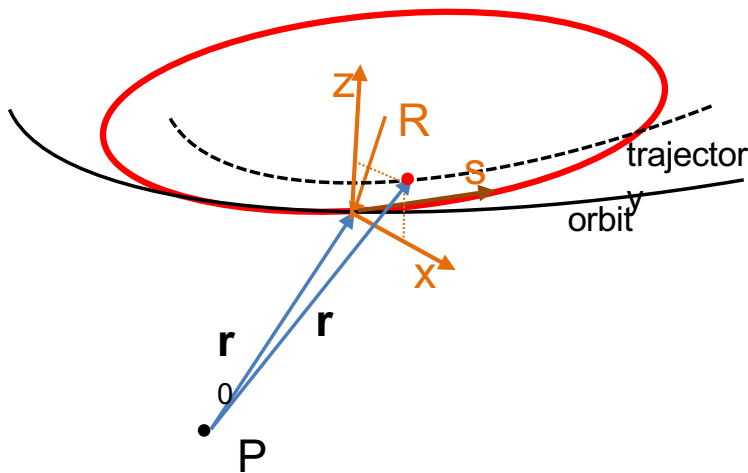

Rotating co-moving reference system
named also Frenet-Serret reference
system

Linear Beam Optics

Equations of motion

To determine $\dot{\mathbf{r}}$ and $\ddot{\mathbf{r}}$ is useful to set:

$$\dot{x} = \frac{dx}{ds} \frac{ds}{dt} = x' \dot{s} \quad \ddot{x} = x'' \dot{s}^2 + x' \ddot{s}$$

then

$$\dot{\mathbf{r}} = x' \dot{s} \mathbf{x}_0 + z' \dot{s} \mathbf{z}_0 + \left(1 + \frac{x}{R}\right) \dot{s} \mathbf{s}_0$$

$$\ddot{\mathbf{r}} = \left[x'' \dot{s}^2 + x' \ddot{s} - \left(1 + \frac{x}{R}\right) \frac{\dot{s}^2}{R} \right] \mathbf{x}_0 + (z'' \dot{s}^2 + z' \ddot{s}) \mathbf{z}_0 + \left[\frac{2}{R} x' \dot{s}^2 + \left(1 + \frac{x}{R}\right) \ddot{s} \right] \mathbf{s}_0$$

The Lorentz force in presence of $\mathbf{B} \equiv (B_x, B_z, 0)$ is

$$\ddot{\mathbf{r}} = \frac{e}{m} (\dot{\mathbf{r}} \times \mathbf{B})$$

Computing the vector product, using the expressions for $\dot{\mathbf{r}}$ and $\ddot{\mathbf{r}}$ and considering only the transverse components

$$x'' \dot{s}^2 + x' \ddot{s} - \left(1 + \frac{x}{R}\right) \frac{\dot{s}^2}{R} = \frac{e}{m} B_z \left(1 + \frac{x}{R}\right) \dot{s}$$

$$z'' \dot{s}^2 + z' \ddot{s} = \frac{e}{m} B_x \left(1 + \frac{x}{R}\right) \dot{s}$$

Assuming

$$\ddot{s} \approx 0 \quad p = mv \quad \text{and writing} \quad v = \left(1 + \frac{x}{R}\right) \dot{s}$$

$$x'' - \left(1 + \frac{x}{R}\right) \frac{1}{R} = -\frac{v e}{\dot{s} p} B_z \left(1 + \frac{x}{R}\right)$$

$$z'' = \frac{v e}{\dot{s} p} B_x \left(1 + \frac{x}{R}\right)$$

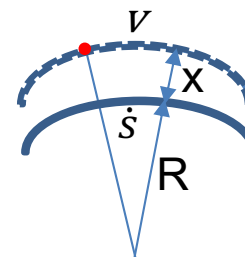

Linear Beam Optics

Equations of motion

Writing the beam momentum p as

$$p = p_0 + \Delta p \quad \text{with } \Delta p \text{ of the order of few } /_{00} \quad \rightarrow \quad \frac{1}{p} = \frac{1}{p_0} \left(1 - \frac{\Delta p}{p} \right)$$

And using the expressions for the dipolar component of the B field

$$x'' - \left(1 + \frac{x}{R} \right) \frac{1}{R} = - \left(1 + \frac{x}{R} \right)^2 \left(\frac{1}{R} - kx \right) \left(1 - \frac{\Delta p}{p} \right)$$

$$z'' = - \left(1 + \frac{x}{R} \right)^2 kx \left(1 - \frac{\Delta p}{p} \right)$$

$$\frac{e}{p_0} B_z = \frac{1}{R} - kx \quad \frac{e}{p_0} B_x = -kz$$

Since $x \ll R$, $z \ll R$ and $\frac{\Delta p}{p} \ll 1$

All the higher order terms in x , z and $\frac{\Delta p}{p}$ can be ignored

$$x''(s) + \left(\frac{1}{R^2(s)} - k(s) \right) x(s) = \frac{1}{R} \frac{\Delta p}{p}$$

$$z'' = k(s)z(s) = 0$$

Hill's equations describe the linear motion of a particle in a storage ring:

they are non-linear

focusing terms have opposite sign in the transverse planes

In first approximation $\frac{\Delta p}{p}$ affects the horizontal motion only

they look like harmonic oscillator

are the starting point for any calculations in the beam optics field

Linear Beam Optics

General solution of the motion equations

Aiming at computing the motion properties of a beam (many particles)

Betatron oscillations:

Starting from

$$x''(s) + \left(\frac{1}{R^2(s)} - k(s) \right) x(s) = \frac{1}{R} \frac{\Delta p}{p} \quad (a)$$

assuming $1/R = 0$ and $\Delta p/p_0 = 0$

$$x''(s) - k(s)x(s) = 0$$

harmonic oscillator having a restoring term depending on s

solution can be obtained by the trial function

$$x(s) = Au(s) \cos[\psi(s) + \varphi] \quad \text{with } A \text{ and } \varphi \text{ set by initial conditions}$$

computing x'' , substituting in (a) and grouping all the terms in $A \cos[\psi(s) + \varphi]$ and $A \sin[\psi(s) + \varphi]$ it gets to an equation which can only be satisfied if :

$$\begin{aligned} u'' - u\psi'^2 - k(s)u &= 0 & (b) \\ 2u'\psi' + u\psi'' &= 0 \quad \rightarrow \quad 2\frac{u'}{u} + \frac{\psi''}{\psi'} = 0 \quad \text{integrating} \quad \psi(s) = \int_0^s \frac{d\sigma}{u^2(\sigma)} \quad \text{ins. in (b)} \\ u'' - \frac{1}{u^3} - k(s)u &= 0 \end{aligned}$$

non linear differential equation, having no general analytical solution, which can be solved numerically only

Linear Beam Optics

Betatron oscillations:

Replacing

$$A = \sqrt{\varepsilon} \quad \text{and} \quad \beta(s) = u^2(s)$$

$$x(s) = \sqrt{\varepsilon} \sqrt{\beta(s)} \cos[\psi(s) + \varphi]$$

in a magnetic structure beam particles move executing betatron oscillation, around the nominal orbit, in each one of the transverse plane (x,z)

Betatron oscillation are:

- anharmonic
- non periodic
- their amplitude along s is modulated by the function β
- their phase varies as $\psi'(s) = \frac{1}{\beta(s)}$
- their maximum amplitude defines the envelope, X , of the particle trajectories $X = \pm \sqrt{\varepsilon} \sqrt{\beta(s)}$ -> the transverse beam size
- the number of betatron oscillations in a turn depends on the focusing strength in the corresponding plane

β function is:

- always positive
- periodic $\beta(s) = \beta(s + L)$
- single value
- reach its maximum in the Q_F and its minimum in Q_D
- unit of measurement [m]

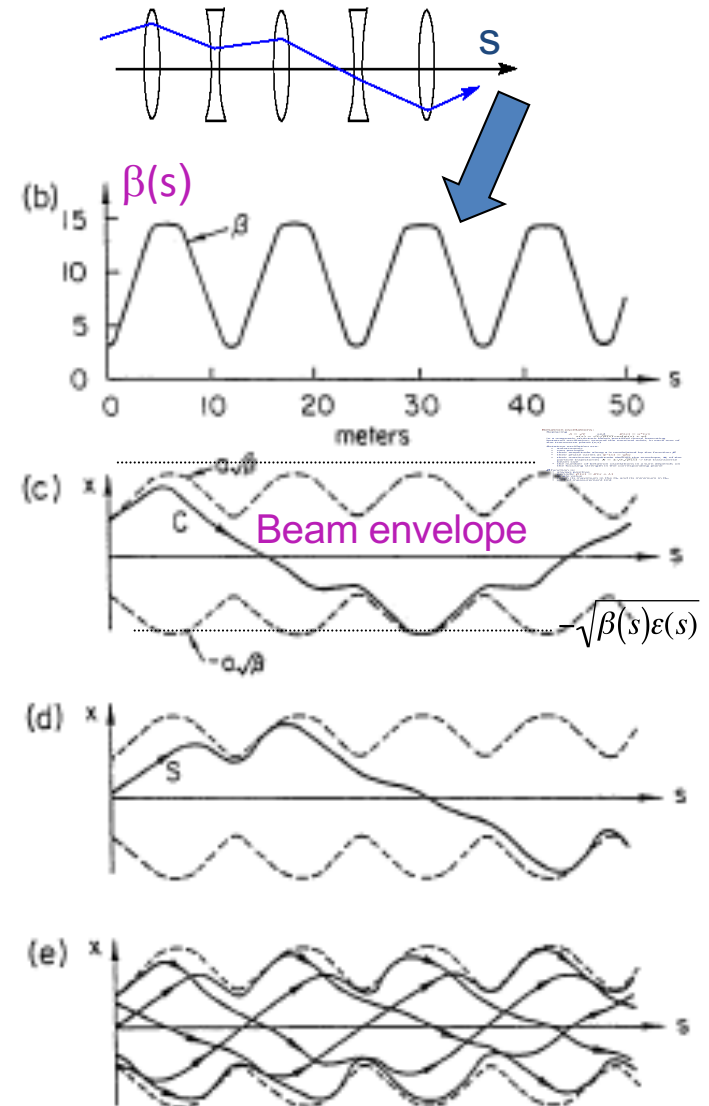

All the stable trajectories lie within the envelope

Betatron Oscillation Amplitude β

Can be easily measured, since a focusing error induces $\Delta\mu$

$$\Delta\mu = \frac{1}{4\pi} \beta \Delta k ds$$

Quadrupole strength is varied by modifying the current I of the magnet power supply

To measure β it's necessary to know the calibration constant

$$k = cst * I$$

QUAI1023 (ks100, ci1023)

$ks100 = (ci1023 / ABS(ci1023)) * (c1s * (ABS(ci1023) + eps + di1023) + c2s) / en$

$c1s = 9.1277$

$c2s = 4.53$

Betatron Oscillation Phase Advance

$$\psi(s) = \int_0^L \frac{1}{\beta(s)} ds$$

As far as a circular accelerator is considered:
consisting of N cells
having a total circumference C

The phase change per revolution becomes:

$$N\psi(s)$$

From operative point of view becomes very useful to define the ***betatron phase advance per turn***

$$\mu = \frac{N\psi(s)}{2\pi}$$

$$\mu = \frac{1}{2\pi} \int_s^{s+C} \frac{1}{\beta(s)} ds \quad \text{tunes } \mu_x, \mu_z$$

Tunes:

must avoid integer values

are dimensionless and measurable parameters (principally their fractional part)

Linear Beam Optics

Emittance

To unveil ε properties it's worth writing an expression for the particle motion in $x(s)$ and $x'(s)$

$$x(s) = \sqrt{\varepsilon} \sqrt{\beta(s)} \cos[\psi(s) + \varphi]$$

$$x'(s) = -\frac{\sqrt{\varepsilon}}{\sqrt{\beta(s)}} [\alpha(s) \cos[\psi(s) + \varphi] + \sin[\psi(s) + \varphi]]$$

$$\alpha(s) = -\frac{\beta'(s)}{2}$$

Eliminating the terms depending on the phase $\psi(s)$

$$\frac{x^2}{\beta(s)} + \left(\frac{\alpha(s)}{\sqrt{\beta(s)}} x + \sqrt{\beta(s)} x' \right)^2 = \varepsilon$$

$$\gamma(s) = \frac{1 + \alpha^2(s)}{\beta(s)}$$

$$\gamma(s)x^2(s) + 2\alpha(s)x(s)x'(s) + \beta(s)x'^2(s) = \varepsilon$$

Courant-Snyder invariant

This is the general equation for the area of an ellipse A_{ell}

$$A_{ell} = \varepsilon \pi$$

A beam contains many particles so it's necessary to understand which is the ellipse to associate to the beam emittance

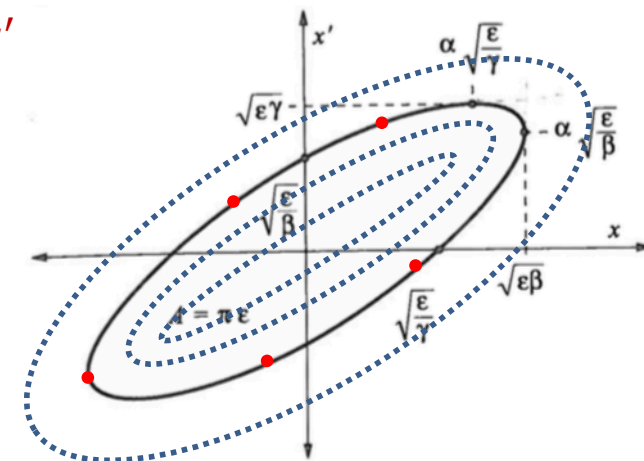

Linear Beam Optics

Liouville's Theorem

Consider an ensemble obeying canonical equations, the volume element defined by any trajectory in the phase space is invariant w.r.t. time

For a particle accelerator this holds if:

energy = constant

synchrotron radiation emission and space charge related effects are negligible

In the case of a lepton beam the charge density distribution function is Gaussian in the transverse and longitudinal dimension

$$\rho(x, z) = \frac{Ne \beta \gamma_e}{2\pi\sigma_x\sigma_z} e^{-\frac{x^2}{2\sigma_x^2} - \frac{z^2}{2\sigma_z^2}}$$

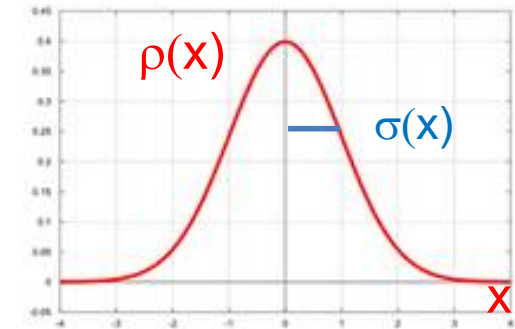

It's reasonable to take $1 \sigma_x$ of the statistical particle distribution as reference emittance value for the whole beam

$$\sigma_x = \sqrt{\varepsilon_{ave} \beta(s)}$$

$$\pi \varepsilon_{ave} = [mm \ mrad]$$

synchrotron radiation emission determines fluctuations in ε_{ave}

In the case of accelerated particles the Liouville's theorem can be still used after applying a canonical transformation to the motion equation

Linear Beam Optics

Emittance evolution through a storage ring cell

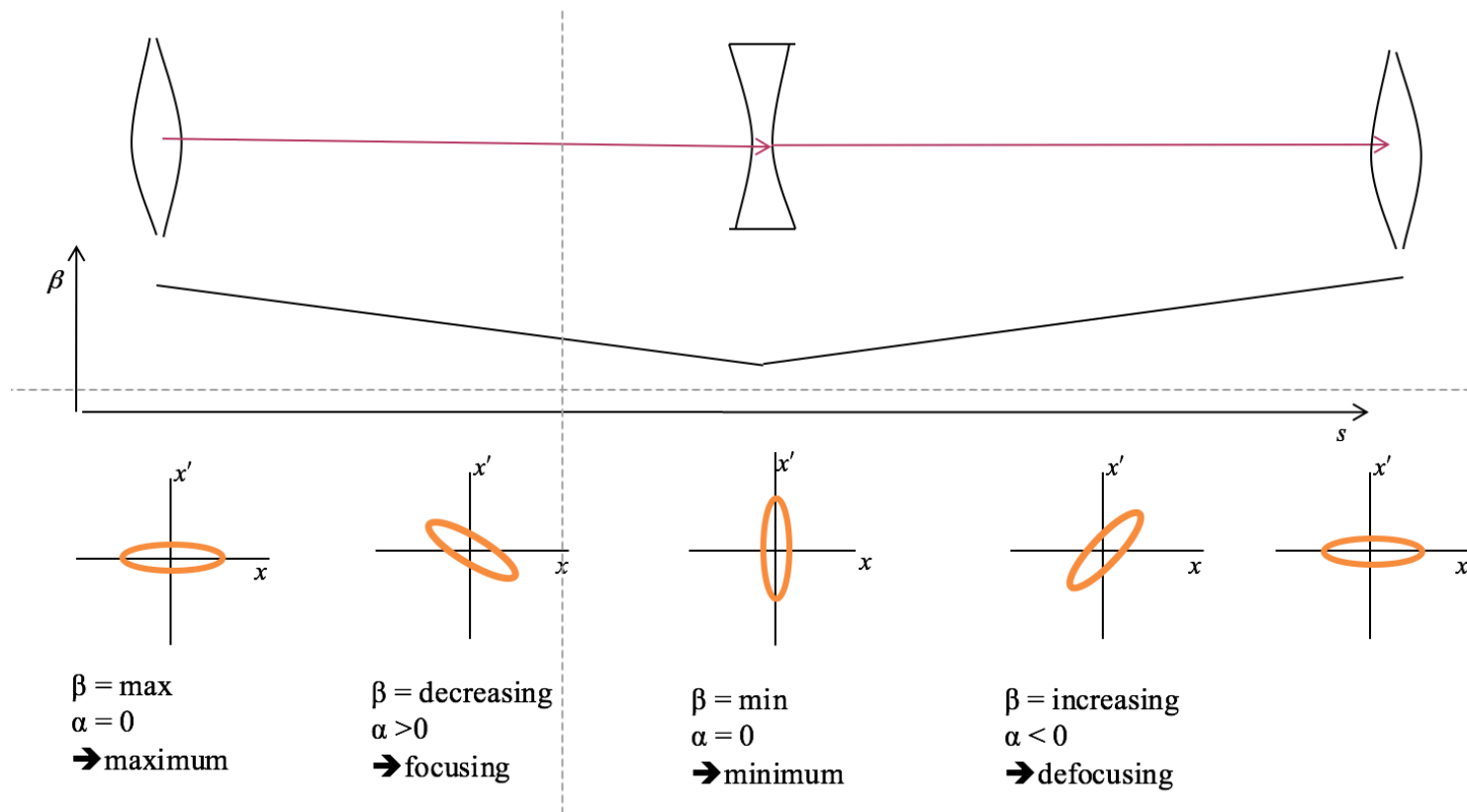

Ellipse shape and orientation vary along the storage ring cell but its area remains constant as far as the beam energy is constant

Particle Accelerator basic components

- *Bending magnets*
- *Quadrupoles*
- *Sextupoles*
- *RF cavity*

Magnete curvante dipolo

Consentono di curvare la traiettoria delle particelle
Dipolo elettromagnetico

Rigidità magnetica $\rho B [Tm] = \frac{p}{q} = \frac{E}{cq}$

$$\frac{1}{\rho} \approx 0.3 \frac{B [T]}{p [GeV/c]}$$

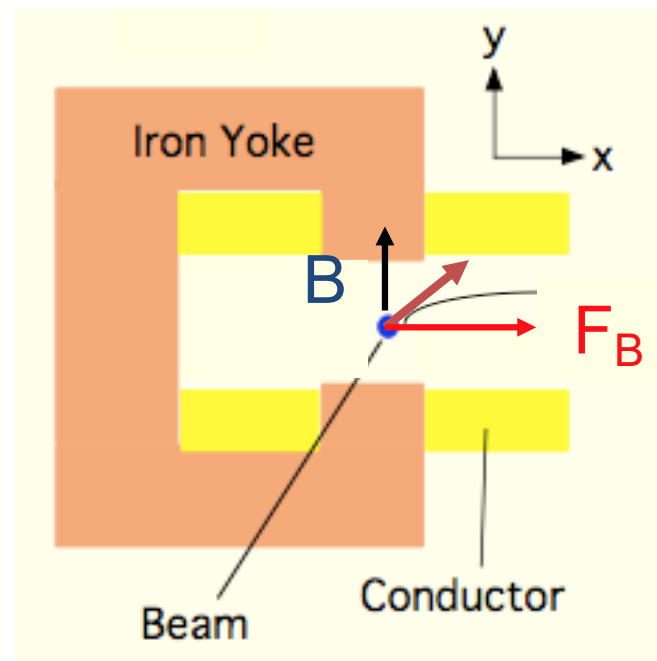
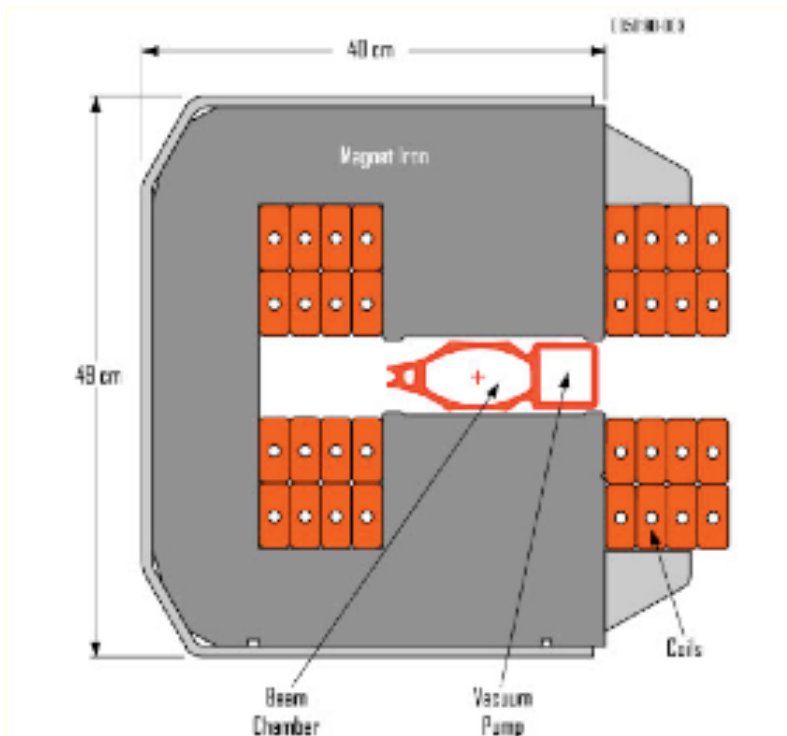

i dipoli elettromagnetici vengono usati per produrre B non oltre
 $B_{MAX} \leq 2 T$

Cosa fare per ottenere campi magnetici più intensi?



B = 1 ÷ 8 T

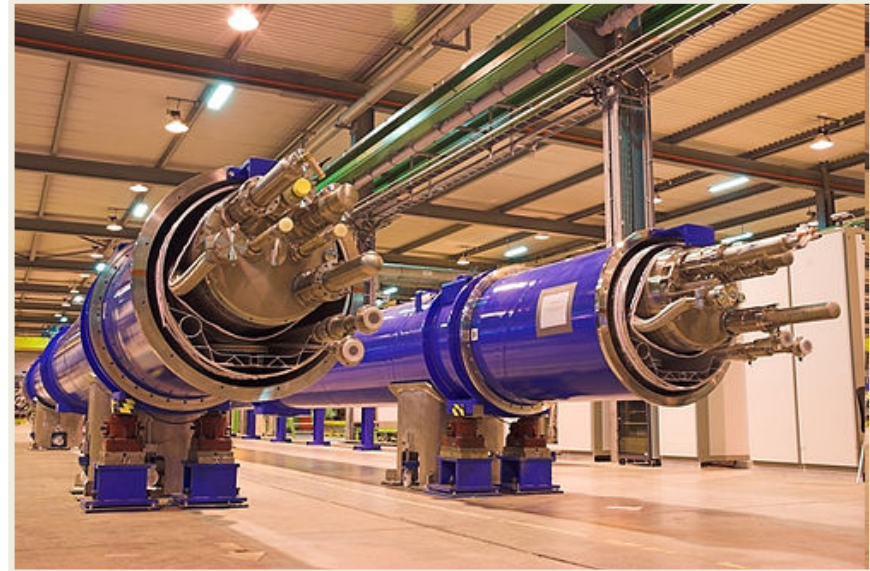

Quadrupole Magnets

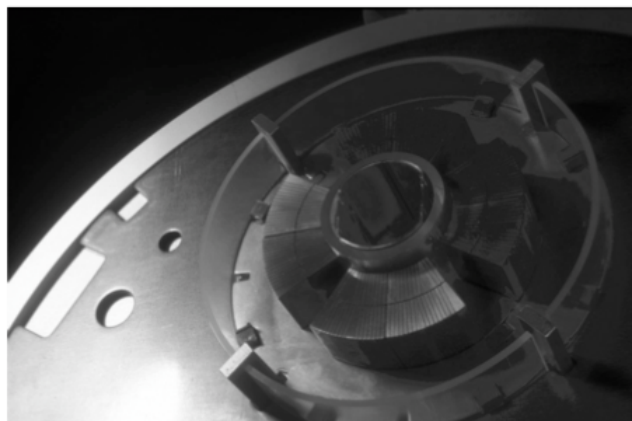
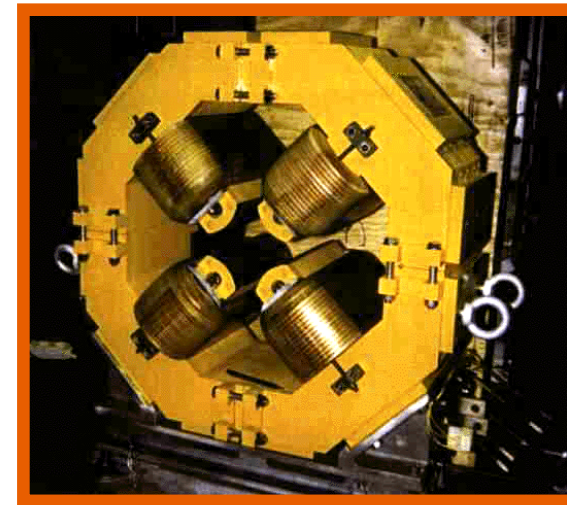
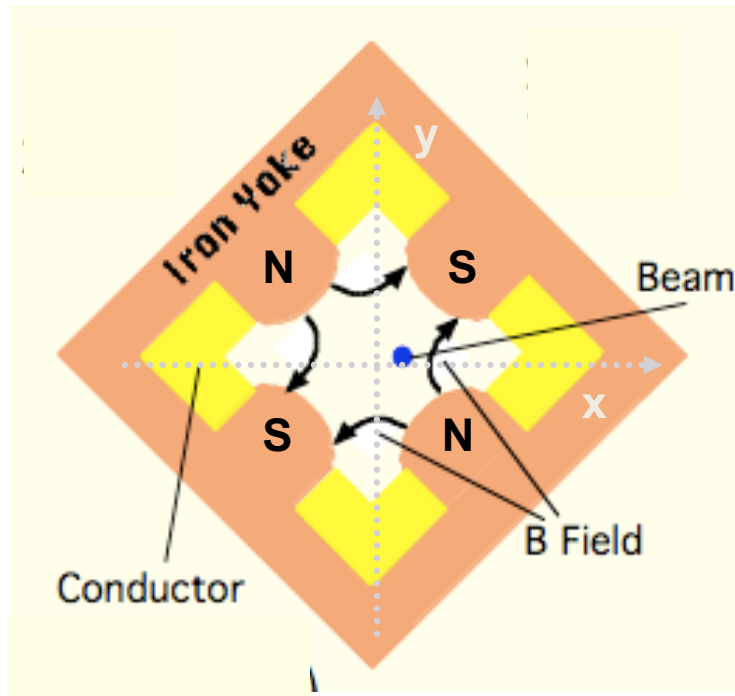

LHC main quadrupole magnet

$g \approx 25 \dots 220 \text{ T/m}$

B

- $B=0$ at $x=0$ $z=0$
- **B** strength grows linearly with the displacement w.r.t. the reference axis

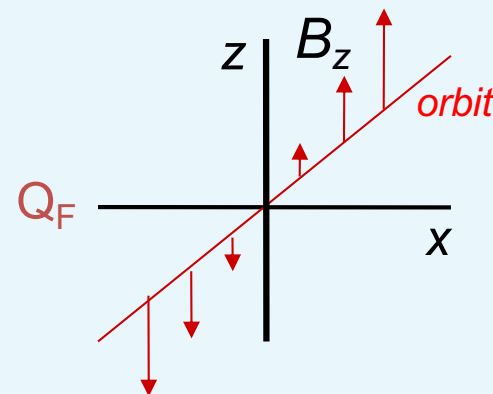

$$F_x = -gx$$

$$F_z = gx$$

$$g = \left[\frac{T}{m} \right]$$

Alternating Gradient Focusing

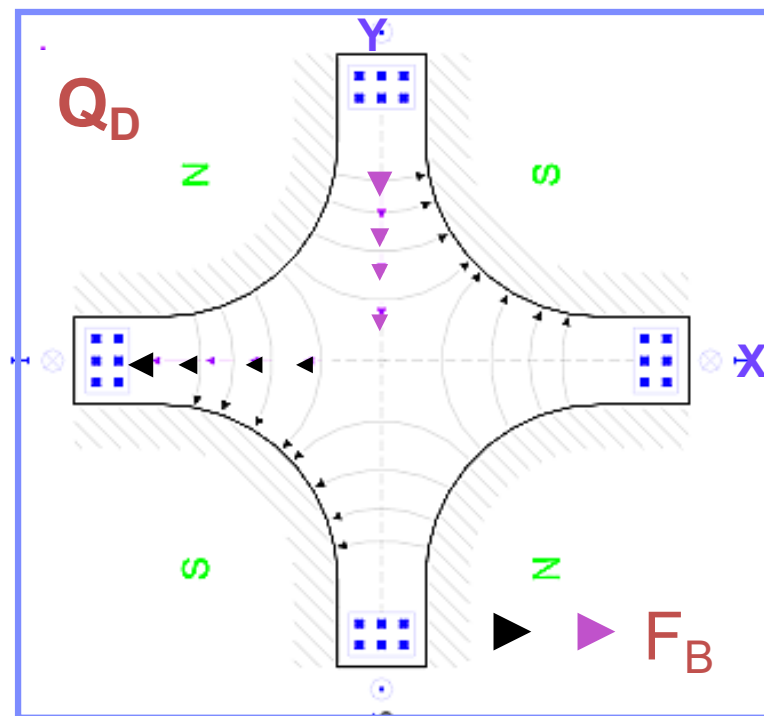
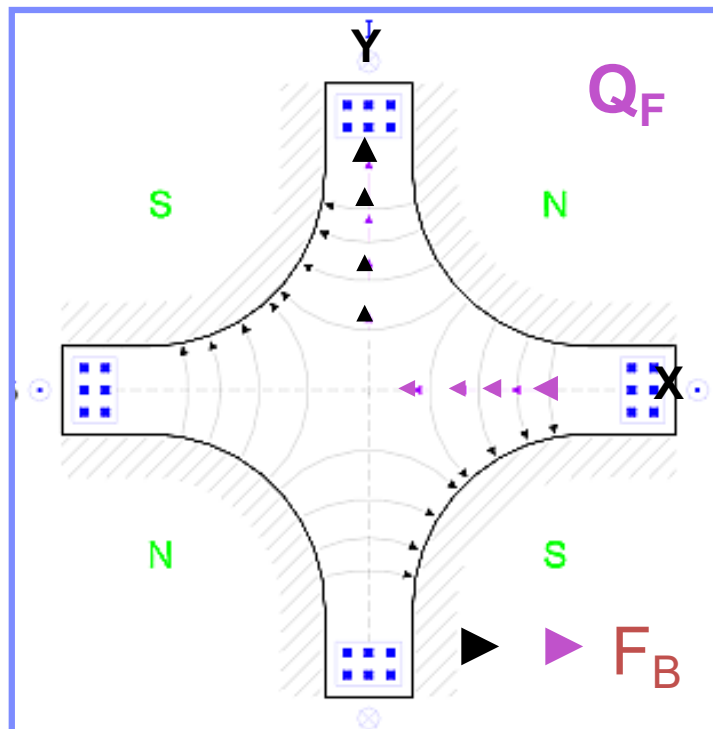

Strong Focusing

Per ottenere il foccheggiamento complessivo di un fascio di particelle lungo un canale di trasporto o in un acceleratore circolare bisogna usare una sequenza di quadrupoli con il segno alternato

Tale configurazione è in grado di garantire traiettorie stabili con piccole deviazioni dai valori nominali

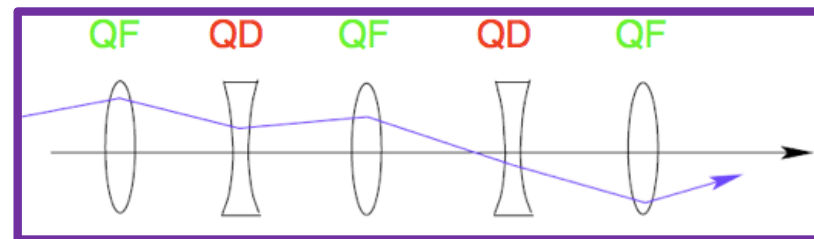

Sestupolo

Aberrazioni cromatiche:
I quadrupoli focheggiano in maniera
diversa particelle con diversa energia

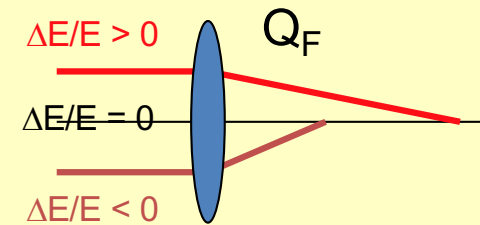

Sestupolo

Genera un campo nullo nel centro del magnete
La variazione del campo magnetico dipende quadraticamente
dallo spostamento trasversale

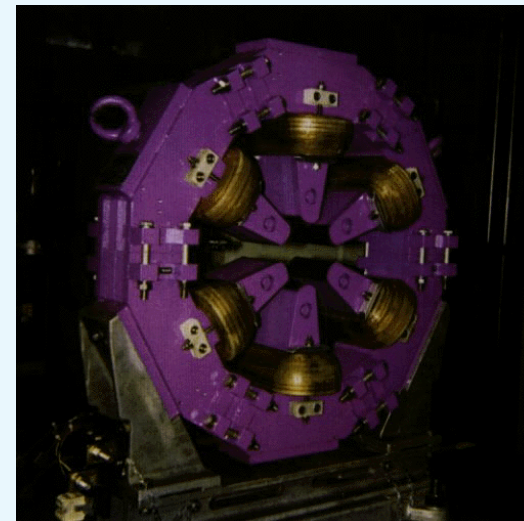
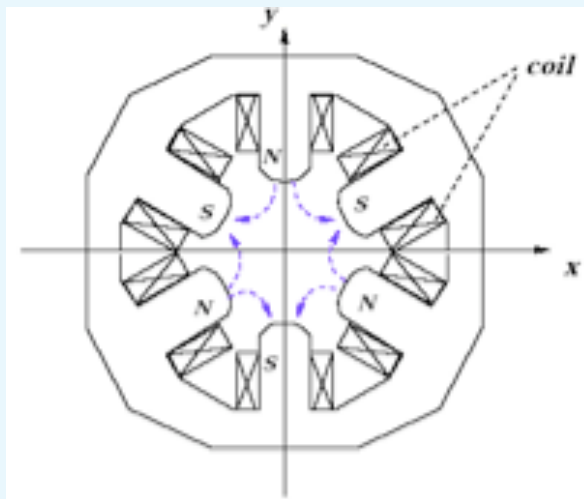

Trajectories for $\Delta p/p \neq 0$

Particles with different momentum passing through bending magnets follow different orbit or trajectory

$$x''(s) + \left(\frac{1}{R^2(s)} - k(s) \right) x(s) = \frac{1}{R} \frac{\Delta p}{p}$$

inhomogeneous differential equations

Considering a $x_d(s)$
$$x_d''(s) + \left(\frac{1}{R^2(s)} \right) x_d(s) = \frac{1}{R} \frac{\Delta p}{p}$$

normalizing by $\Delta p/p$ and defining
$$\eta(s) = \frac{x_d(s)}{\frac{\Delta p}{p}}$$

$$\eta''(s) + \left(\frac{1}{R^2(s)} \right) \eta(s) = \frac{1}{R} \quad (a)$$

Assuming a constant particular solution of (a) η_p

$$\eta_p = R$$

In analogy with what seen for a dipole

$$\eta(s) = A \cos \frac{s}{R} + B \sin \frac{s}{R} + R \quad \eta(0) = \eta_0 \quad \eta'_0(0) = \eta'_0 \quad A = \eta_0 - R \quad B = \eta'_0 R$$

$$\eta'(s) = -\frac{A}{R} \sin \frac{s}{R} + \frac{B}{R} \cos \frac{s}{R}$$

$$\eta(s) = \eta_0 \cos \frac{s}{R} + \eta'_0 R \sin \frac{s}{R} + R \left(1 - \cos \frac{s}{R} \right)$$

$$\eta'(s) = -\frac{\eta_0}{R} \sin \frac{s}{R} + \eta'_0 \cos \frac{s}{R} + \sin \frac{s}{R}$$

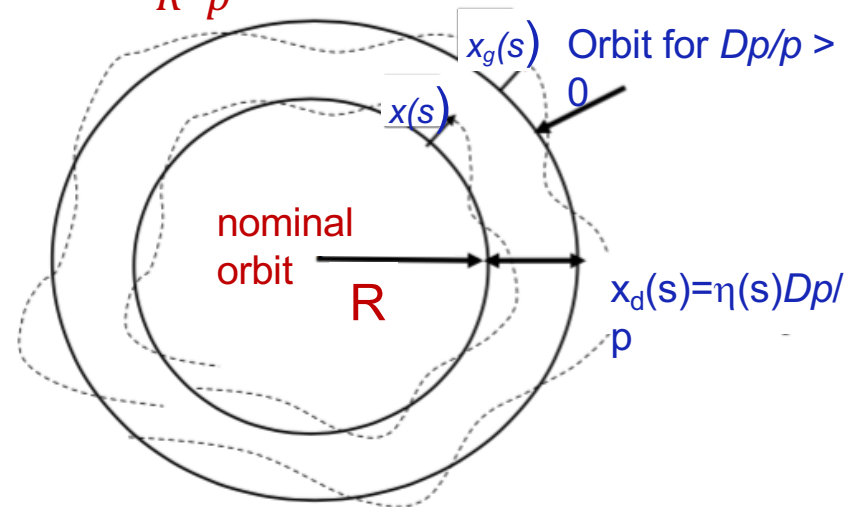

Dispersion Function η

The function η at a point s can be computed knowing its value at $s=0$ by using the matrix

$$\begin{pmatrix} \eta(s) \\ \eta'(s) \\ 1 \end{pmatrix} = \begin{pmatrix} \cos \frac{s}{R} & R \sin \frac{s}{R} & R \left(1 - \cos \frac{s}{R}\right) \\ -\frac{1}{R} \sin \frac{s}{R} & \cos \frac{s}{R} & \sin \frac{s}{R} \\ 0 & 0 & 1 \end{pmatrix} \begin{pmatrix} \eta_0 \\ \eta'_0 \\ 1 \end{pmatrix}$$

The general equation for the trajectory of a particle having a momentum different from the nominal one is

$$x_g(s) = \sqrt{\varepsilon} \sqrt{\beta(s)} \cos[\psi(s) + \varphi] + \eta(s) \frac{\Delta p}{p}$$

η function can be regarded as the orbit corresponding to a particle having $Dp/p = 1$
the orbit of a particle is the sum of $x(s)$ plus η

Unit measurement [m]

Dispersion Function η

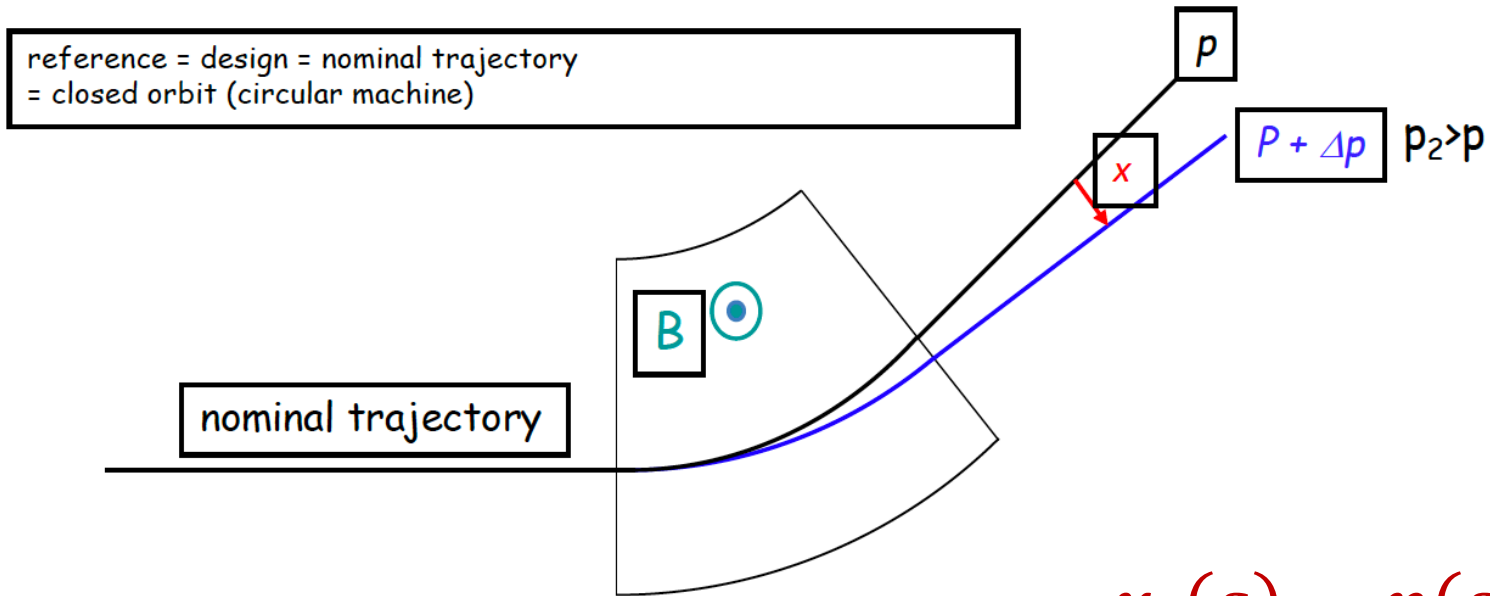

$$x_\eta(s) = \eta(s) \frac{\Delta p}{p}$$

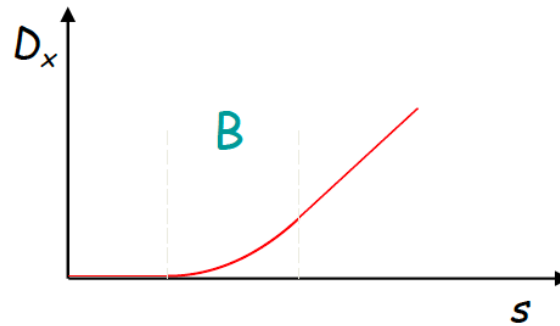

Effetto dei dipoli sul moto trasverso di particelle con energia E diversa da quella nominale E_0

Per particelle ultrarelativistiche $E = p \cdot c$

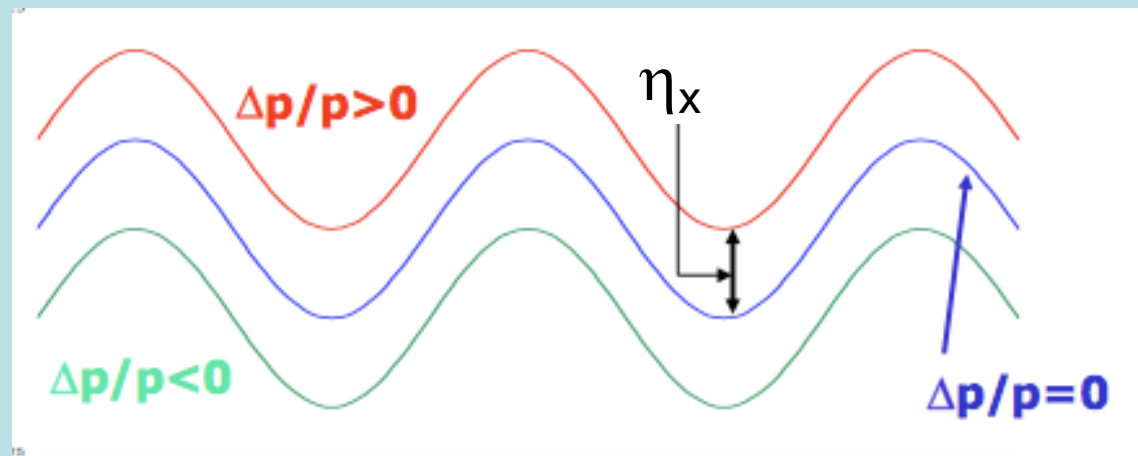

La particella con $Dp/p \neq 0$ compie oscillazioni di betatrone intorno ad un'orbita diversa da quella nominale

La funzione che descrive di quanto l'orbita fuori energia si discosta da quella nominale si chiama dispersione

$$\eta(s) [m]$$

Momentum Compaction Factor α_c

It's important to study the dependence of the relative variation of the orbit length on the relative variation of momentum

$$\frac{ds'}{R + x_\eta} = \frac{ds}{R}$$

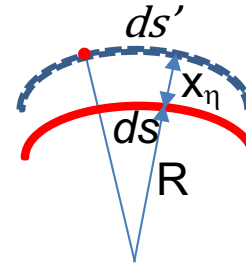

$$\oint ds' = \oint \frac{R + x_\eta}{R} ds$$

$$L' = L_0 + \frac{\Delta p}{p} \oint \frac{\eta(s)}{R(s)} ds$$

$$\frac{\frac{\Delta L}{L_0}}{\frac{\Delta p}{p_0}} = \frac{1}{L_0} \frac{\Delta p}{p} \oint \frac{\eta(s)}{R(s)} ds$$

$$\alpha_c = \frac{1}{L_0} \frac{\Delta p}{p} \oint \frac{\eta(s)}{R(s)} ds$$

$$\frac{\Delta L}{L_0} = \alpha_c \frac{\Delta p}{p_0}$$

Effetto dei quadrupoli sul moto trasverso di particelle con energia E diversa da quella nominale E_0

$Dp/p > 0$ le particelle sentono un foccheggiamento minore $\rightarrow v < v_0$

$Dp/p < 0$ le particelle sentono un foccheggiamento maggiore $\rightarrow v > v_0$

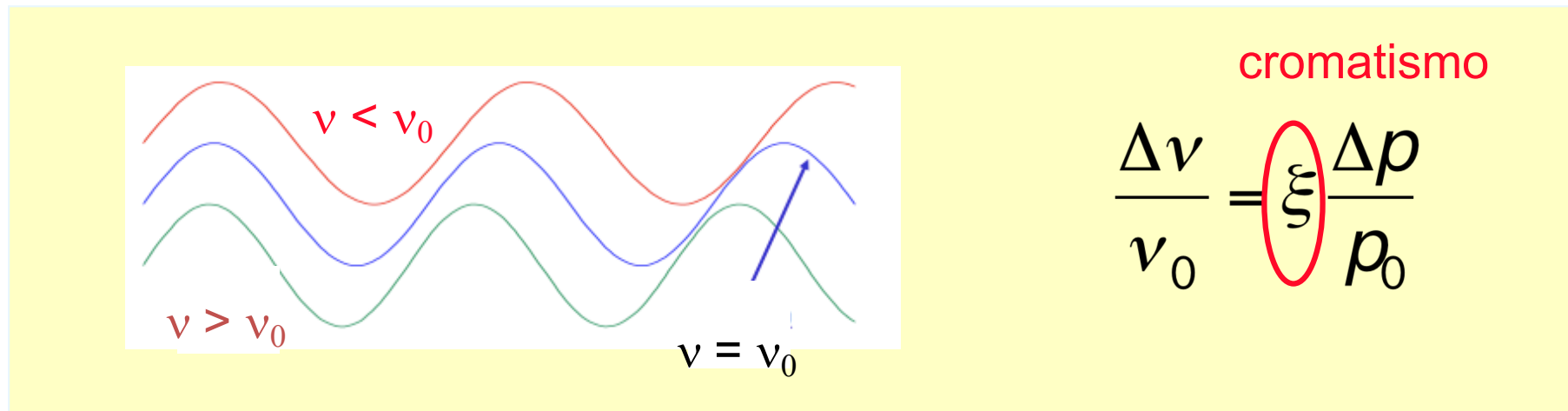

La dipendenza del numero di oscillazione di betatrone delle particelle accumulate dall'energia è cruciale per la stabilità del fascio

ξ deve essere corretto accuratamente

Chromaticity ξ

Consider a particle having $\Delta p \ll p_0$ passing through a quadrupole magnet

$$k(p) = -\frac{e}{p_0} g = \frac{e}{p_0 + \Delta p} g$$

$$k(p) \simeq -\frac{e}{p_0} g \left(1 - \frac{\Delta p}{p_0}\right) \quad k(p) = k_0 + \Delta k \quad \Delta k = k_0 \frac{\Delta p}{p_0}$$

A momentum error induces a focusing error $\rightarrow \Delta\mu$

$$\Delta\mu = \frac{1}{4\pi} \beta \Delta k ds \quad \Delta\mu = \frac{1}{4\pi} \beta k_0 \frac{\Delta p}{p_0} ds$$

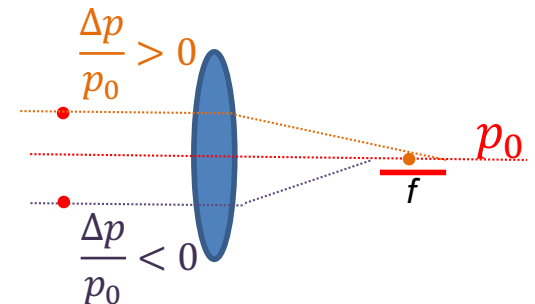

Since the particle maintain the same Δp for several turns it's possible to integrate the r.h.s. over all the quadrupoles

$$\frac{\Delta\mu}{\Delta p/p_0} = \frac{1}{4\pi} \oint \beta k_0 ds \quad \xi = \frac{\Delta\mu}{\Delta p/p_0}$$

Properties of ξ :

measurable and dimensionless quantity

generated always when a particle is focused $\xi = f(k(s))$

Is due to the lattice elements $\rightarrow \xi_n$ **natural chromaticity**

It indicates the size of the tune spot in the tune diagram

For an accelerator based on strong focusing ξ_n will be predominantly < 0

Chromaticity Correction

Can be implemented by means of magnet elements having:

$B=0$ on the nominal orbit

focusing strength depending quadratically on x (z)

$$k_{sxt} = \frac{e}{p} g' x = m_{sxt}(s) x$$

$$x_g = x(s) + \eta(s) \frac{\Delta p}{p}$$

$$x_d(s) = \eta(s) \frac{\Delta p}{p}$$

Sextupoles should be installed at place where there is dispersion

SEXTUPOLES

$$\xi_{tot} = \frac{1}{4\pi} \oint [m_{sxt}(s)\eta(s) + k(s)] \beta(s) ds$$

Chromaticity must be corrected to avoid to incur in resonances and must be moved to values >0 to avoid the head-tail instability

However too high Sextupole gradients can lead to lose particles

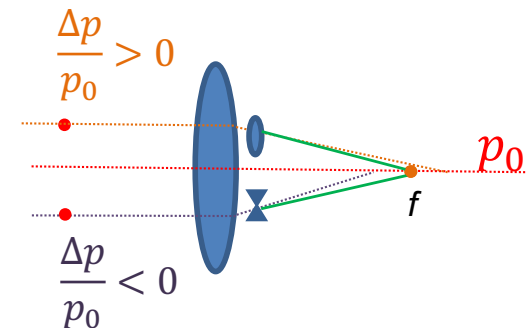

Radiazione di Sincrotrone

Particelle in moto su un'orbita circolare quando passano all'interno di un magnete curvante emettono radiazione in direzione tangente alla loro traiettoria

U energia persa per giro

$$U = \frac{4\pi}{3} \frac{r_o}{(m_0 c^2)^3} \frac{E^4}{\rho}$$

E energia della particella
 ρ raggio di curvatura
 m_0 massa della particella

$$\frac{m_p}{m_e} = 1836$$

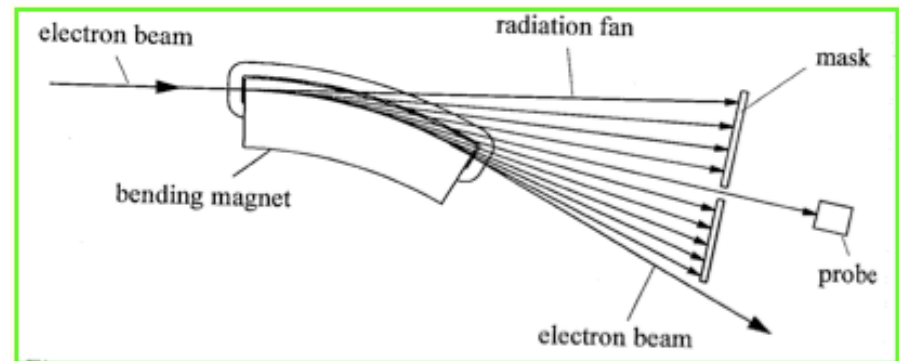

$$\frac{U_{e^-}}{U_p} = \frac{m_p^3}{m_e^3} \approx 10^{13}$$

- A parità di **E** e **ρ** un elettrone emette molta più radiazione di sincrotrone di un protone
- La radiazione di sincrotrone emessa da protoni è stata osservata per la prima volta al Tevatron

Limiti imposti dalla Radiazione di Sincrotrone

L'energia persa per emissione di radiazione di sincrotrone viene reintegrata mediante una **cavità a Radio Frequenza**

$$U_{MAX} = P_{MAX}^{RF}$$

$$E_{MAX} [GeV] \propto (\rho [m] U_{MAX})^{1/4}$$

- *Data una certa potenza RF si può costruire un acceleratore con energia maggiore aumentandone il raggio*
- *Raddoppiare l'energia a parità di potenza RF richiede un acceleratore con raggio 16 volte maggiore*

e ⁺ e ⁻	DAΦNE	U ~ 9.7 KeV	E = .51 GeV	L = 97.58 m	}
e ⁺ e ⁻	LEP	U ~ 700 MeV	E = 70 GeV	L = 27 Km	
p p	LHC	U ~ 7 KeV	E = 7000 GeV	L = 27 Km	

Acceleratori con energia $E \gg 200$ GeV è preferibile che usino adroni (protoni, antiprotoni o ioni) oppure che siano acceleratori lineari

Longitudinal Dynamics

Circular accelerators use powerful **Radio Frequency** structure to generate high intensity \mathcal{E}_f with frequency f_{RF} in the range: $100 \text{ MHz} \leq f_{RF} \leq \text{GHz}$

The field \mathcal{E}_f is intended to restore the energy lost by synchrotron radiation emission

E_0 nominal energy

W_0 average energy lost per turn

$$V = V_0 \sin(\omega t + \omega_0)$$

$$\omega = 2\pi f_{RF}$$

$$f_{RF} = n f_r = n \frac{2\pi}{T_r}$$

Energy balance for a nominal particle over a turn

$$E_0 = eV_0 \sin \psi_0 - W_0 \quad (a)$$

Energy balance for a particle with small $\Delta p \rightarrow \Delta \psi$

$$E = eV_0 \sin(\psi_0 + \Delta \psi) - W \quad (b)$$

Subtracting (a) from (b) and considering

$$\Delta \dot{E} = \frac{\Delta E}{T_r}$$

$$E - E_0 = eV_0 [\sin(\psi_0 + \Delta \psi) - \sin \psi_0] - \frac{\Delta W}{\Delta E} \Delta E$$

$$\Delta \dot{E} = \frac{eV_0}{T_r} [\sin(\psi_0 + \Delta \psi) - \sin \psi_0] - \frac{\Delta W}{\Delta E} \frac{\Delta E}{T_r}$$

How does T_r changes with Δp ?

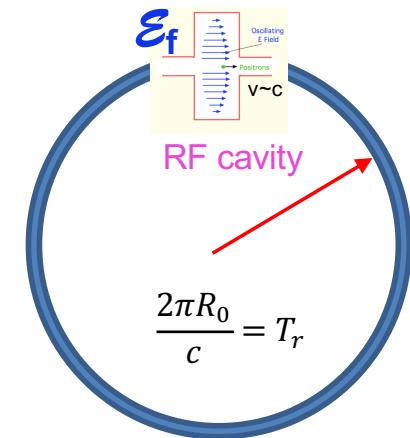

Longitudinal Dynamics

How does T_r changes with Δp ?

$$T_r = \frac{2\pi R_0}{\beta c}$$

$$\beta = \frac{v_0}{c} \quad (\text{beware!!!!})$$

$$\frac{\Delta T}{T_r} = \frac{dR}{R_0} - \frac{d\beta}{\beta_0}$$

$$\frac{dR}{R_0} = \alpha_c \frac{\Delta p}{p} \quad \text{and} \quad \frac{d\beta}{\beta_0} = \frac{1}{\gamma^2} \frac{\Delta p}{p}$$

being $f_r = 1/T_r$

$$f_r = \frac{\beta c}{2\pi R_0}$$

$$\frac{\Delta f}{f_r} = \frac{d\beta}{\beta_0} - \frac{dR}{R_0} = \frac{1}{\gamma^2} \frac{\Delta p}{p} - \alpha_c \frac{\Delta p}{p}$$

defining

$$\eta_c = \frac{\frac{\Delta f}{f_r}}{\frac{\Delta p}{p}}$$

$$\text{phase slip factor} \quad \eta_c = \left(\frac{1}{\gamma^2} - \alpha_c \right)$$

in a lepton storage ring $\eta_c = -\alpha_c$

linear accelerator structures $\alpha_c = 0$

in a synchrotron may happen $\eta_c = 0$

Phase Focusing Effect

$$V(t) = V_0 \sin \omega t = V_0 \sin \psi$$

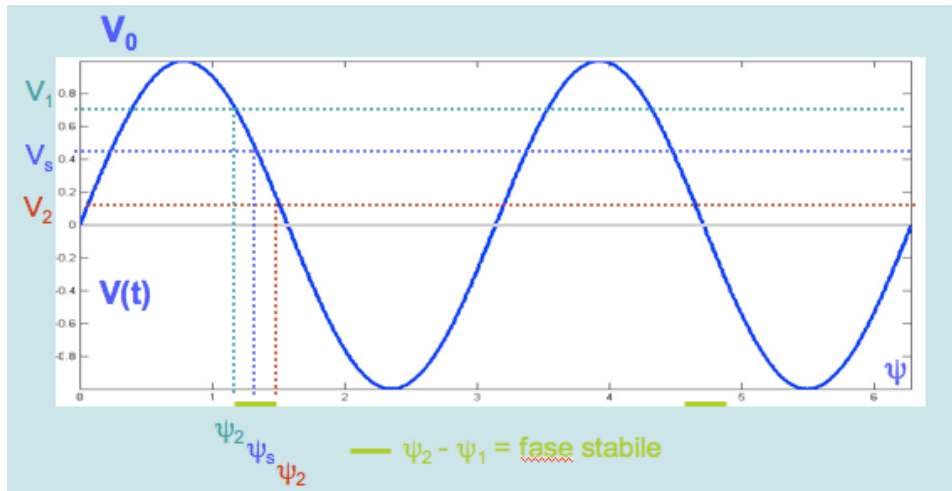

$$\omega = 2\pi f_{RF} = 2\pi n f_r$$

f_r revolution frequency
 f_{RF} RF frequency
 n harmonic number

$$n = \frac{f_{RF}}{f_r}$$

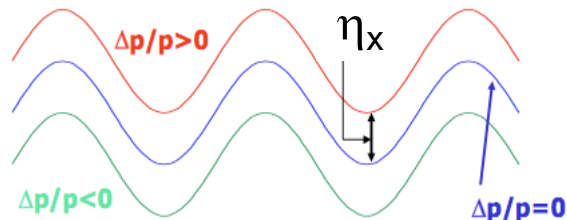

$\Delta p/p = 0$	$V = V_0$	synchronous particle, unchanged
$\Delta p/p > 0$	$V_2 < V_0$	slowed
$\Delta p/p < 0$	$V_1 > V_0$	accelerated

Particles undergo energy oscillation **SYNCHROTRON OSCILLATION**

$n_s =$ number of oscillation per turn

Particles arriving in the RF cavity at t :

$$t \notin t_2 - t_1$$

are lost -> **BUNCHES**

Longitudinal Dynamics

Let us writing the **longitudinal motion equation** going back to the equation

$$\Delta \dot{E} = \frac{eV_0}{T_r} [\sin(\psi_0 + \Delta\psi) - \sin \psi_0] - \frac{\Delta W}{dE} \frac{\Delta E}{T_r}$$

Since $\Delta\psi \ll \psi_0$

$$\sin(\psi_0 + \Delta\psi) - \sin \psi_0 \approx \Delta\psi \cos \psi_0$$

an expression for $\Delta\psi$ is required

$$\Delta\psi = \frac{2\pi\Delta t}{T_{RF}} = \omega_{RF}\Delta t$$

$$\Delta\psi = n\omega_r \Delta t$$

$$\Delta\psi = 2\pi n \frac{\Delta t}{T_r}$$

$$\frac{\omega_{RF}}{\omega_r} = n$$

$$\Delta\psi = 2\pi n \left(\alpha_c - \frac{1}{\gamma^2} \right) \frac{\Delta p}{p}$$

$$\Delta\dot{\psi} = \frac{2\pi n}{T_r} \left(\alpha_c - \frac{1}{\gamma^2} \right) \frac{\Delta p}{p} \quad \frac{\Delta p}{p} = \frac{1}{\beta^2} \frac{\Delta E}{E}$$

$$\Delta\dot{\psi} = \frac{2\pi n}{\beta^2 T_r} \left(\alpha_c - \frac{1}{\gamma^2} \right) \frac{\Delta E}{E}$$

$$\Delta \dot{E} = \frac{eV_0}{T_r} \Delta\psi \cos \psi_0 - \frac{\Delta W}{dE} \frac{\Delta E}{T_r}$$

differentiating again w. r. t. time

$$\Delta \ddot{E} = \frac{eV_0}{T_r} \Delta \dot{\psi} \cos \psi_0 - \frac{\Delta W}{dE} \frac{\Delta E}{T_r}$$

$$\Delta \ddot{E} + 2\alpha_s \Delta \dot{E} + \Omega^2 \Delta E = 0$$

Longitudinal Dynamics

$$\Omega^2 = \frac{1}{T_r} \left[-\frac{2\pi n e V_0}{\beta^2 E} \cos \psi_0 \left(\alpha_c - \frac{1}{\gamma^2} \right) \right]^{1/2} \quad \text{Synchrotron frequency}$$

$$\alpha_s = \frac{1}{2T_r} \frac{\Delta W}{dE} \quad \text{damping term usually small} \quad \alpha_s \ll \Omega$$

and the solution

$$\Delta E(t) = \Delta E_0 e^{-\alpha_s t} e^{i\Omega t}$$

There are **stable longitudinal oscillation only if** $\Omega \in \Re$

$$\cos \psi_0 \left(\alpha_c - \frac{1}{\gamma^2} \right) < 0$$

which defines two stable phase areas

$$\begin{aligned} \frac{\pi}{2} < \psi_0 < \frac{3\pi}{2} & \quad \text{when} & \quad \alpha_c > \frac{1}{\gamma^2} \\ -\frac{\pi}{2} < \psi_0 < \frac{\pi}{2} & \quad \text{when} & \quad \alpha_c < \frac{1}{\gamma^2} \end{aligned}$$

When $\gamma_{tr} = \frac{1}{\sqrt{\alpha_c}} \quad \Omega \rightarrow 0$ the longitudinal focusing effect vanishes

Colliders

Cinematica delle collisioni tra fasci

VANTAGGI

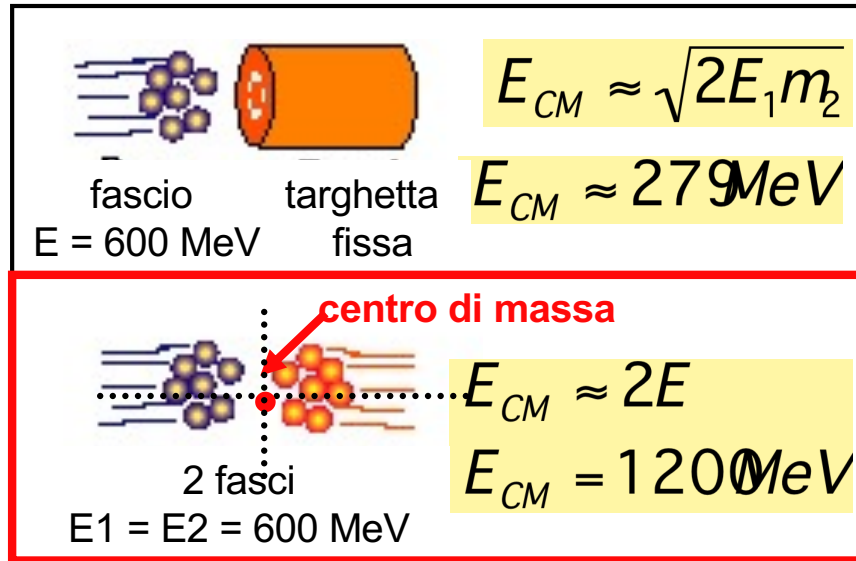

Parte dell'energia del fascio incidente è spesa nel loro rimbalzo sulla targhetta

Tutta l'energia dei due fasci è a disposizione per realizzare le collisioni

LIMITE

La densità dei fasci relativistici che si sanno realizzare è molto bassa rispetto a quella della materia condensata di una targhetta.

Uno dei fasci circolanti in DAFNE contiene un numero di particelle n_p

$$N_p = 100 \cdot 10^{10}$$

IL CONCETTO di SEZIONE D'URTO

Due particelle che collidono possono produrre tipi diversi di eventi, alcuni più probabili di altri

la *sezione d'urto* σ di un determinato evento è proporzionale alla probabilità che l'evento avvenga
si misura in cm^2

Luminosità L

Come ottenere il più alto numero di eventi possibili?

N_e è il numero di eventi prodotti dalle collisioni

σ_p è la probabilità di ottenere un dato evento dall'urto tra particelle collidenti (sezione d'urto del processo da studiare)

L è il numero di collisioni realizzate per unità di superficie A per unità di tempo

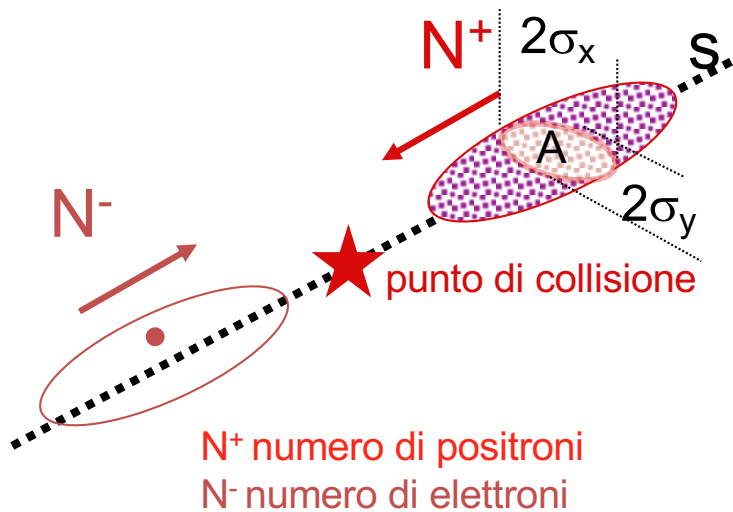

$$\frac{\Delta N_e}{\Delta t} = \sigma_p L \quad \text{Numero di eventi nell'unità di tempo}$$

$$\frac{\Delta N_e}{\Delta t} = \sigma_p \frac{f_r b N^+ N^-}{4\pi\sigma_x\sigma_y}$$

$$I = N b f_e$$

$$L = \frac{f_r b N^+ N^-}{4\pi\sigma_x\sigma_y}$$

$$L = \frac{I^+ I^-}{4\pi e^2 f_r b \sigma_x \sigma_y}$$

$$L_{\text{integrata}} = L \Delta t$$

Unità di misura

$$L[\text{cm}^{-2}\text{s}^{-1}] = L[10^{33} \text{ nb}^{-1}\text{s}^{-1}]$$

$$1 \text{ b} = 10^{-24} \text{ cm}^2$$

$$\text{nb} = 10^{-9} \text{ b}$$

$f_r = c/L$ frequenza di rivoluzione

b numero dei pacchetti

$f_r b$ frequenza di collisione

Parasitic Crossings

Colliding beams consist of many bunches

Head on collisions determine many parasitic crossings

Crossing angle is introduced to minimize *parasitic crossings*

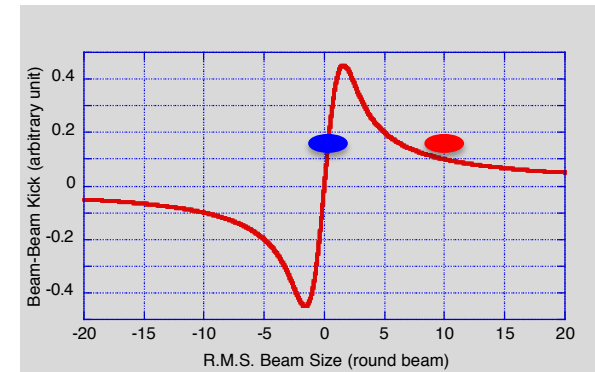
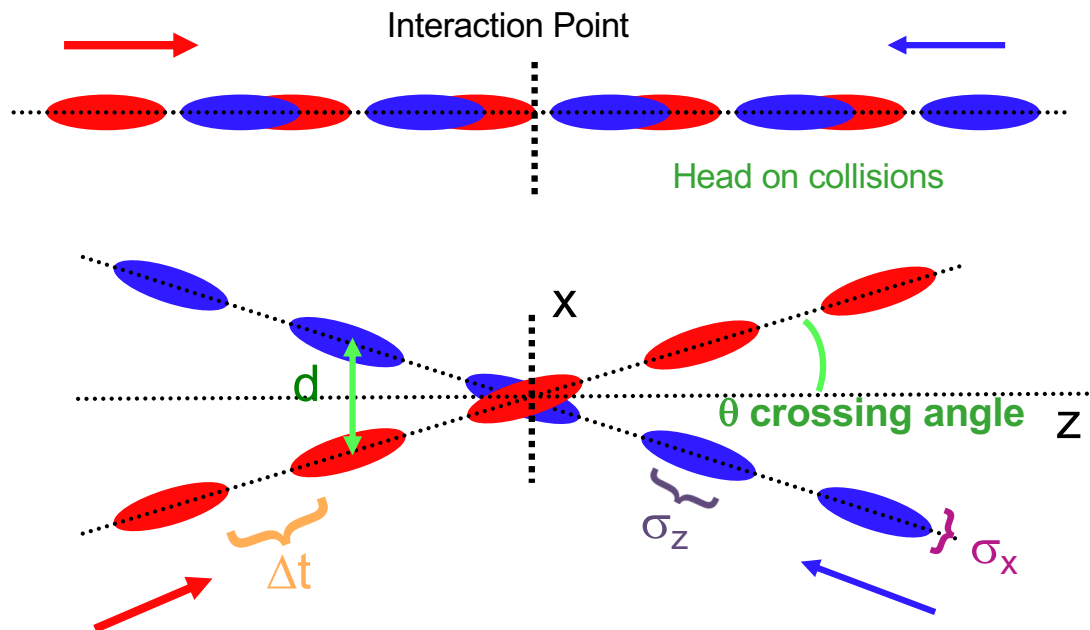

$$\Phi \approx \frac{\sigma_z}{\sigma_x^*} \operatorname{tg}\left(\frac{\theta}{2}\right) < 1$$

Still **Long Range Beam-Beam (LRBB) interactions** is not negligible in fact it cause:

- closed orbit distortion
- correlation between the transverse and longitudinal motion
- excite dangerous resonances

The DAΦNE Accelerator Complex

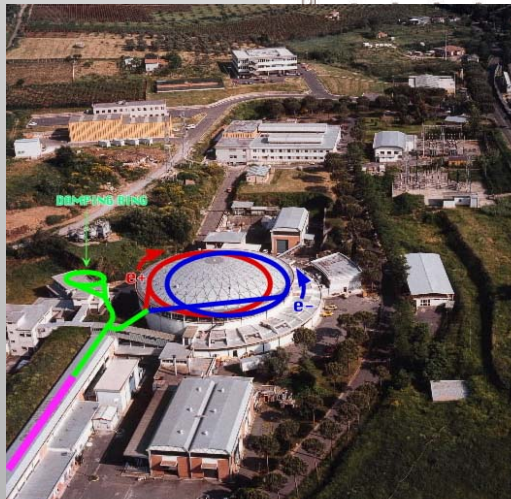
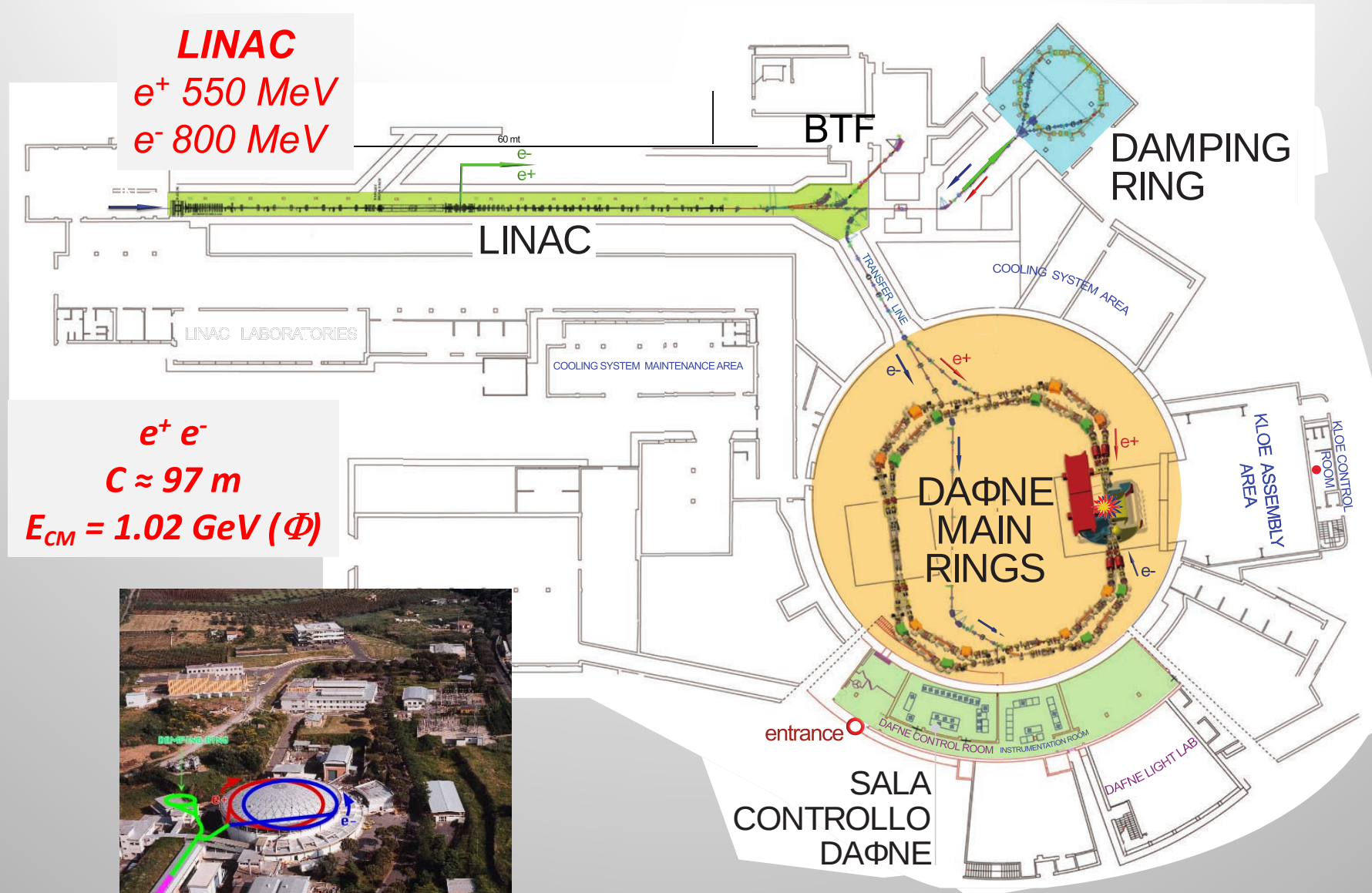

Outline

- *DAΦNE*
- *path toward higher luminosity*
- *Crab-Waist Collision Scheme*
- *Performances of Crab-Waist collisions with:
SIDDHARTA
KLOE-2*
- *Preparation for SIDDHARTA-2 run*
- *Conclusions*

DAΦNE Main Ring Layout and Parameters

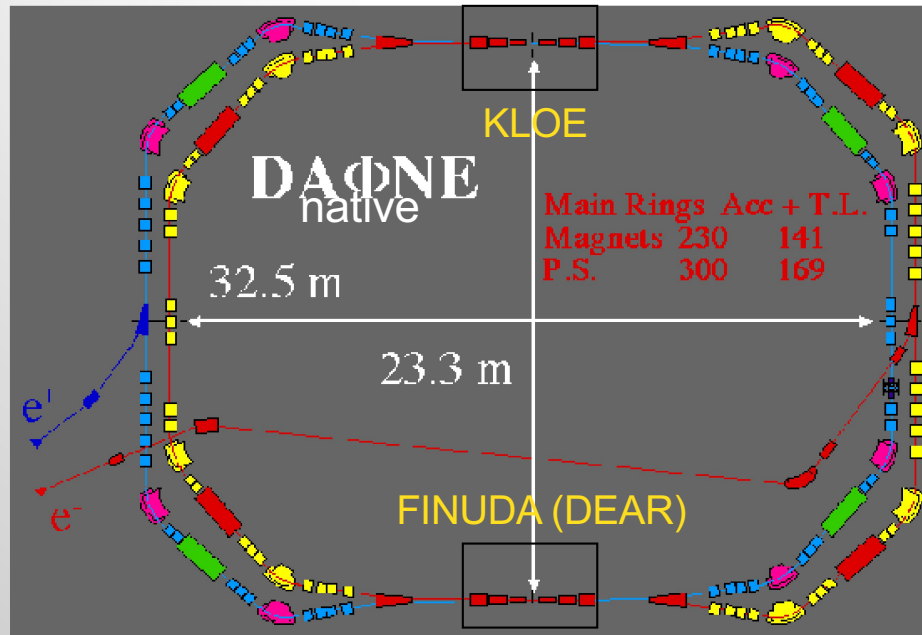

“Proposal for a Φ -factory”, LNF-90/031 (IR), 1990.



	DAΦNE native	DAΦNE Crab-Waist
Energy (MeV)	510	510
$\theta_{\text{cross}}/2$ (mrad)	12.5	25
ϵ_x (mm·mrad)	0.34	0.28
β_x^* (cm)	160	23
σ_x^* (mm)	0.70	0.25
Φ_{Piwinski}	0.6	1.5
β_y^* (cm)	1.80	0.85
σ_y^* (μm) low current	5.4	3.1
Coupling, %	0.5	0.5
Bunch spacing (ns)	2.7	2.7
I_{bunch} (mA)	13	13
σ_z (mm)	25	15
N_h	120	120

Colliding Beams have:
 low E
 high currents
 short bunch spacing 2.7 nsec
 long damping time

Conventional Approach to High Luminosity

$$L = N_b f_0 \frac{N^2}{4\pi\sigma_x^* \sigma_y^*} \quad \xi_{x,y} = \frac{Nr_e}{2\pi\gamma} \frac{\beta_{x,y}^*}{\sigma_{x,y}^* (\sigma_x^* + \sigma_y^*)} \quad L = N_b f_0 \frac{\pi\gamma^2 \xi_x \xi_y \epsilon_x}{r_e^2 \beta_y^*} \left(1 + \frac{\sigma_y^*}{\sigma_x^*}\right)^2$$

Small β_y^*

Higher number of particle per bunch N

More bunches N_b

Higher tune shift $\xi_{x,y}$

Greater horizontal rms beam size σ_x

Small crossing angle θ_x

Small Piwinsky angle $\Phi = \frac{\sigma_z}{\sigma_x} \tan \frac{\theta_x}{2} < 1$

Conventional Approach Meets Limitations

$\beta_y^* \sim \sigma_z$ to avoid hourglass effect

σ_z reduction led to:

- single bunch instability
- bunch lengthening and microwave instabilities
- CSR production

Higher N and N_b

- led to enhanced power losses
- increase wall plug power requirements
- causes coupled bunch instabilities

Tune shifts $\xi_{x,y}$ are constrained by beam-beam limit

Larger σ_x conflicts with

- beam stay clear and dynamical aperture requirements

Long-range beam-beam interactions causing $\tau^+ \tau^-$ reduction limiting $I_{MAX}^+ I_{MAX}^-$ and $\rightarrow L_{peak}$ and L_f

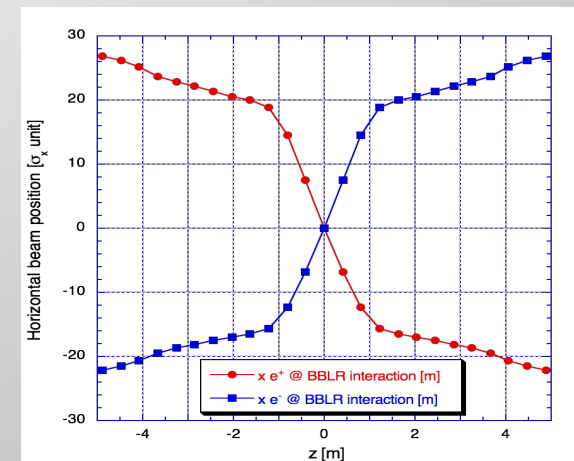
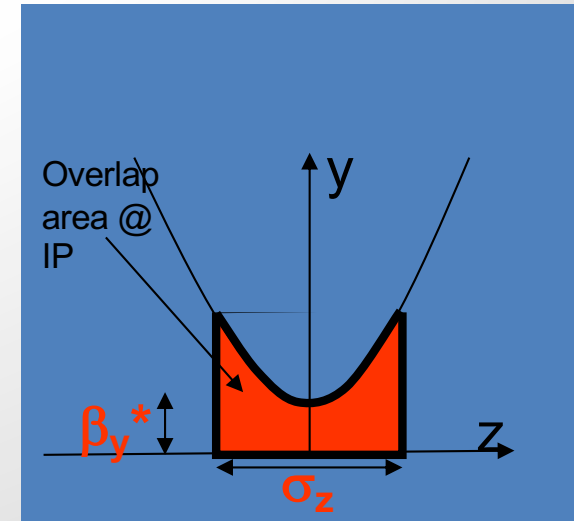

L_{peak} at DAΦNE 2001 ÷ 2007

L_{peak} had a remarkable evolution mainly due to several machine upgrades
Experiments took data one at the time, although DAΦNE had been originally conceived as collider with two IRs

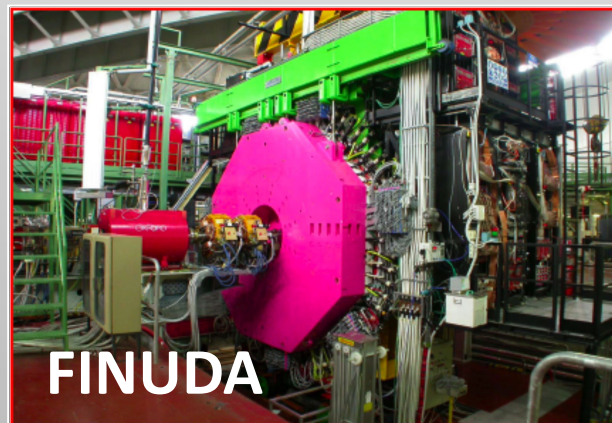
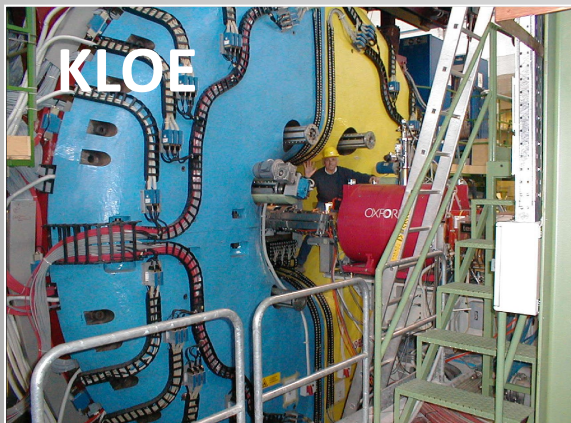
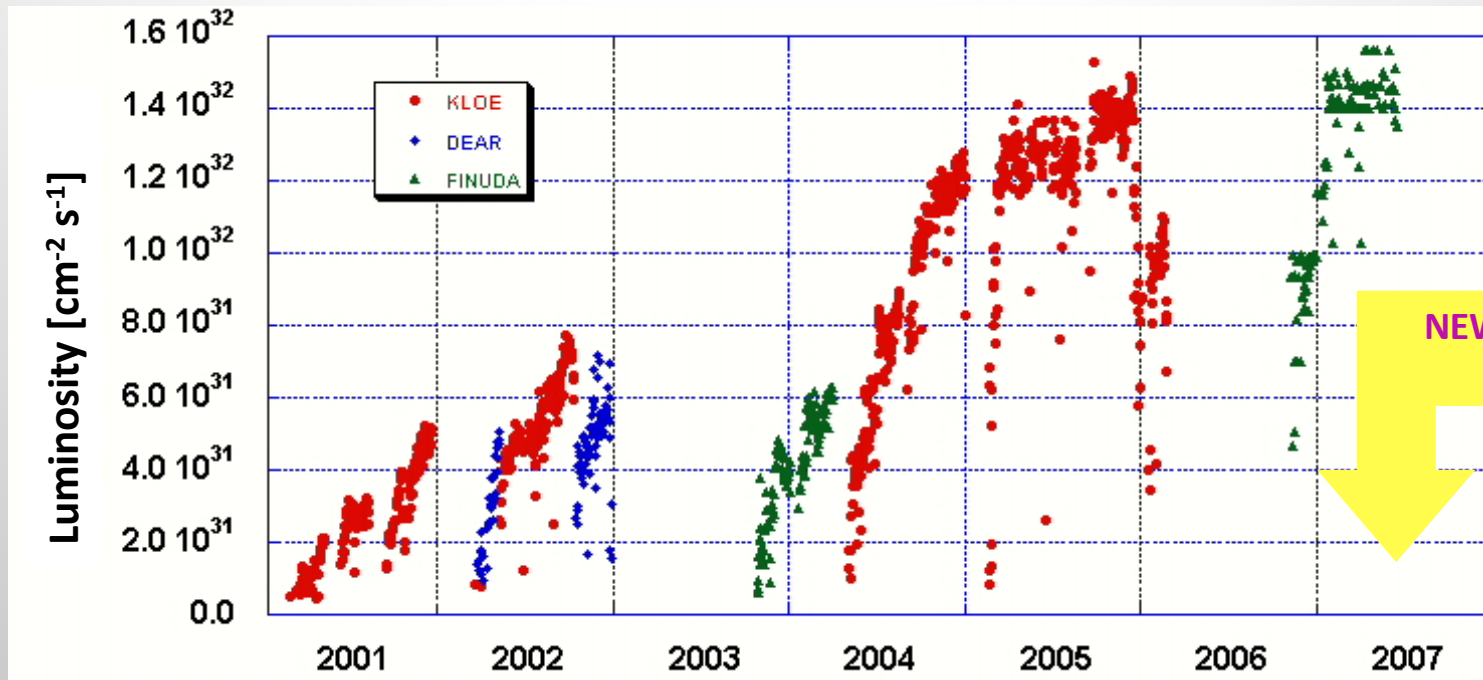

$L_{\text{logged}} (\text{fb}^{-1})$ 2001 ÷ 2007

KLOE	3.0
FINUDA	1.2
DEAR	0.2

Crab-Waist Collision Scheme

The innovative approach to the beam-beam interaction

Large Piwinski angle

Horizontal crossing angle θ

Large Piwinski angle Φ

$$\Phi \approx \frac{\sigma_z}{\sigma_x^*} \frac{\theta}{2}$$

large θ
small σ_x

New IR layout
Lower beam ε

$$\xi_y \propto \frac{N\sqrt{\beta_y^*}}{\sigma_z\theta} \quad \xi_x \propto \frac{N}{(\sigma_z\theta)^2} \quad L \propto \frac{N\xi_y}{\beta_y^*}$$

- lower ζ_x (tune shift)
- $L_{\text{geometric}}$ gain

β_y^* can be reduced for sake of the beams overlap region Σ

$$\Sigma \propto \frac{\sigma_x}{\theta} \quad \beta_y \propto \frac{\sigma_x}{\theta} \ll \sigma_z$$

New low- β section
Ad hoc low- β optics

- L_{geo} gain with the same I_b
- lower ζ_y
- vertical *Synchro-Betatron* resonances suppression
- ζ_y reduction with the synchrotron oscillation amplitude

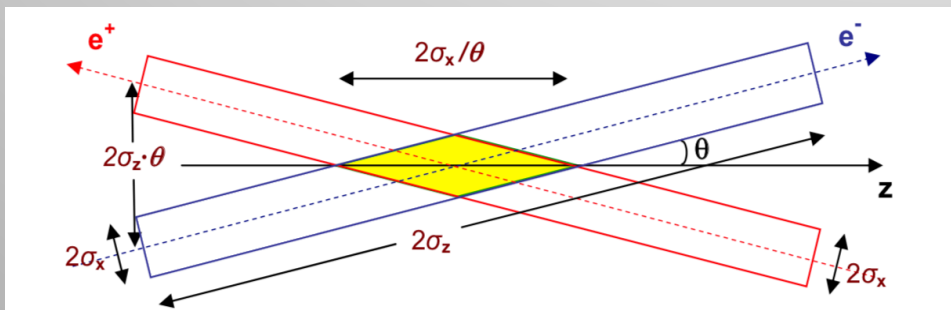

P. Raimondi et al., LNF-07/003 (IR) 29 Gennaio 2007

Crab-Waist Transformation

Collisions with large θ is not a new idea

Crab-Waist transformation is

P. Raimondi, 2^o SuperB Workshop, March 2006,
 P. Raimondi, D. Shatilov, M. Zobov, physics/0702033,
 C. Milardi et al., Int.J.Mod.Phys.A24, 2009.

Powerful Sextupoles
 Proper IR optics

$$y = \frac{xy'}{2\theta}$$

sextupole

(anti)sextupole

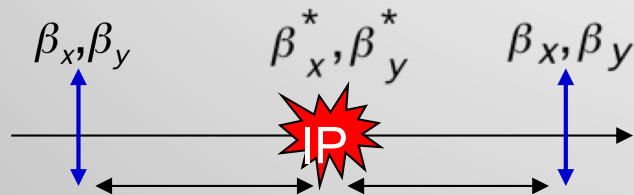

$$\Delta\nu_x = \pi$$

$$\Delta\nu_y = \frac{\pi}{2}$$

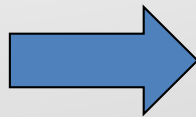

- $L_{\text{geometric}}$ gain
- X-Y synchro-betatron and betatron resonance suppression

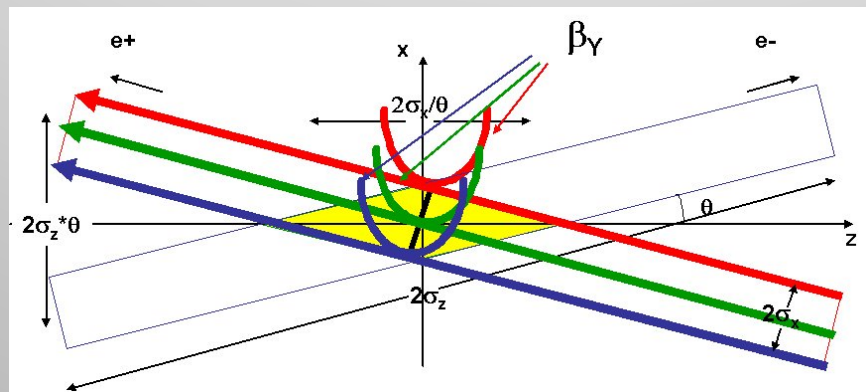

without CW Sextupoles

Large Piwinski angle

Collisions with large θ is not a new idea

Crab-Waist transformation it is

P. Raimondi, 2^o SuperB Workshop, March 2006,
 P.Raimondi, D.Shatilov, M.Zobov, physics/0702033,
 C. Milardi et al., Int.J.Mod.Phys.A24, 2009.

$$y = \frac{xy'}{2\theta}$$

sextupole

(anti)sextupole

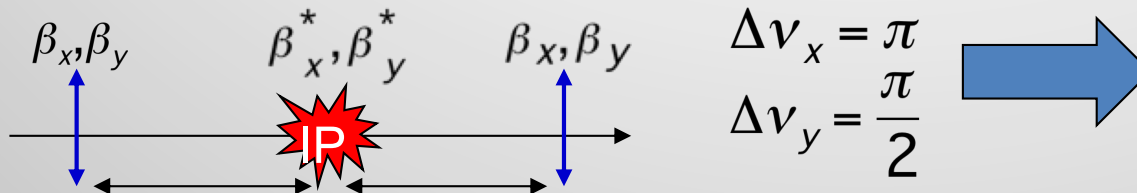

Powerful Sextupoles
 Proper IR optics

- $L_{\text{geometric}}$ gain
- X-Y and synchro-betatron resonances suppression

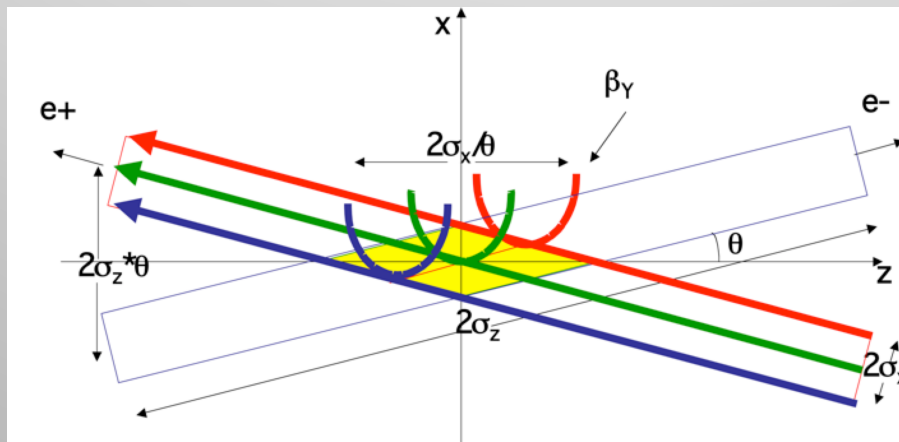

with CW Sextupoles

DAΦNE Upgrade Parameters

	DAΦNE KOE	DAΦNE Upgrade
$\theta_{\text{cross}}/2$ (mrad)	12.5	25
ε_x (mmxrad)	0.34	0.26
β_x^* (cm)	160	26
σ_x^* (mm)	0.70	0.26
Φ_{Piwinski}	0.6	1.9
β_y^* (cm)	1.80	0.85
σ_y^* (μm) low current	5.4	3.1
Coupling, %	0.5	0.5
I_{bunch} (mA)	13	13
σ_z (mm)	25	20
N_{bunch}	110	110
L ($\text{cm}^{-2}\text{s}^{-1}$) $\times 10^{32}$	1.6	5

Beam distribution @ IP

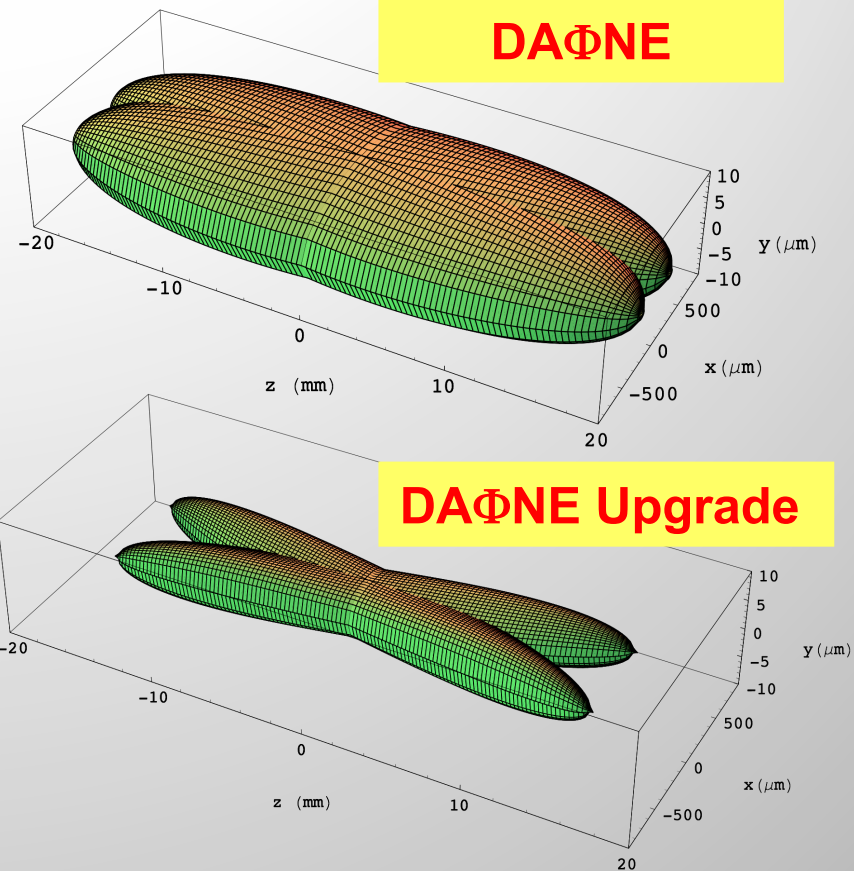

- In 2007 the DAΦNE accelerator complex has been upgraded in order to implement a new collision scheme based on **large Piwinski angle**, **low- β** and **Crab-Waist compensation** of the synchrotron resonances
- The upgrade took **~ five months**
- **Since May 2008** DAΦNE is delivering luminosity to the SIDDHARTA experiment.

Crab-Waist Achievements during SIDDHARTA Run

Crab-Waist collisions and SIDDHARTA

- Large crossing angle and *Crab-Waist* collisions proved to be effective in *increasing luminosity by a factor 3*
- The DAΦNE collider, based on the new collision scheme including Large Piwinski angle and *Crab-Waist*, has been successfully commissioned achieving record performances

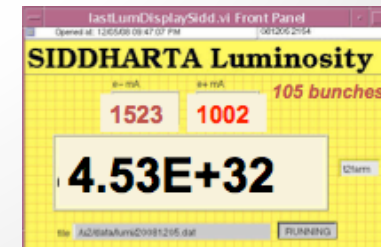

$L_{\text{peak}} = 4.5 \cdot 10^{32} \text{ cm}^{-2} \text{ s}^{-1}$
 $L_{\text{f1 day}} = 15.0 \text{ pb}^{-1}$
 $L_{\text{f1 hour}} = 1.033 \text{ pb}^{-1}$
 $L_{\text{f run}} \sim 2.8 \text{ fb}^{-1}$ (delivered in 18 months)

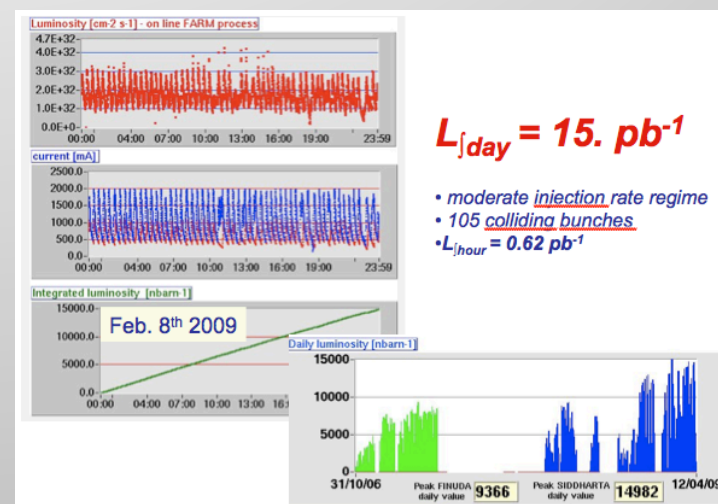
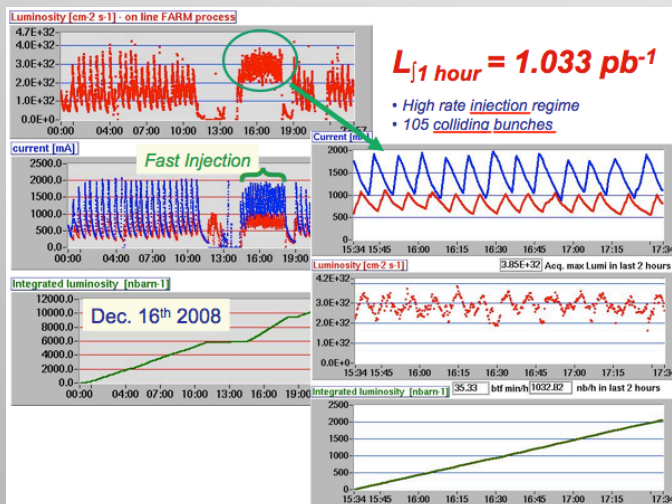
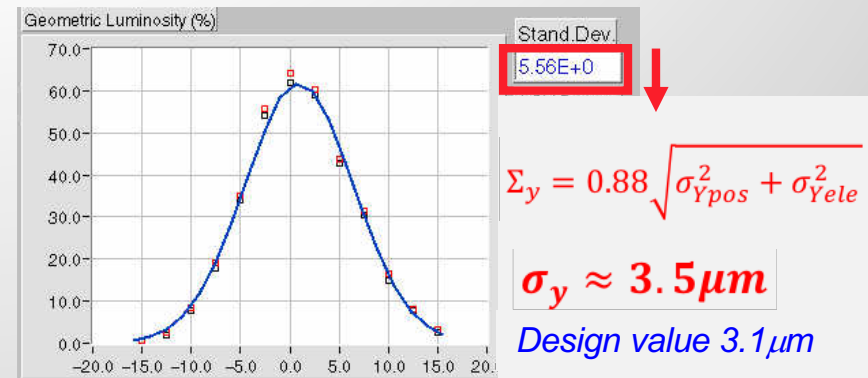

Luminosity at DAΦNE 2001 ÷ 2009

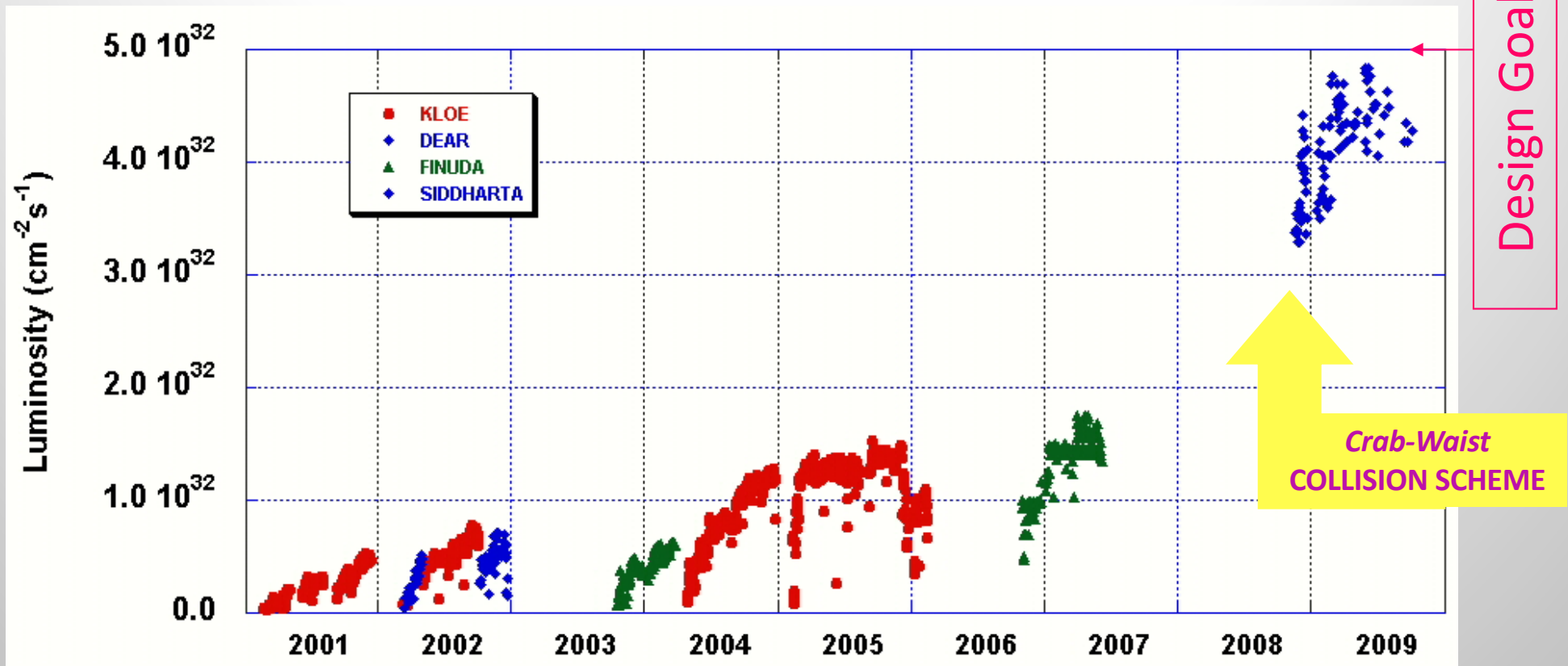

A factor 3 higher luminosity achieved without increasing beam currents

No evidence of vertical BB saturation with *CW-Sextupoles* on ($\xi_y = 0.044$)

LRBB interaction cancelled



Crab-Waist Achievements during KLOE-2 Run

CW-Collision scheme for the KLOE detector

Integrating the high luminosity collision scheme with a large experimental detector introduces new challenges in terms of IR layout, optics, beam acceptance, coupling correction

Crucial Points:

IR optics complying with:

Low- β

Crab-Waist collision scheme

Coupling compensation

Beam trajectory control

IR mechanical design allowing:

Large crossing angle

Early vacuum pipe separation after IP

Mechanical stability of the low- β doublet

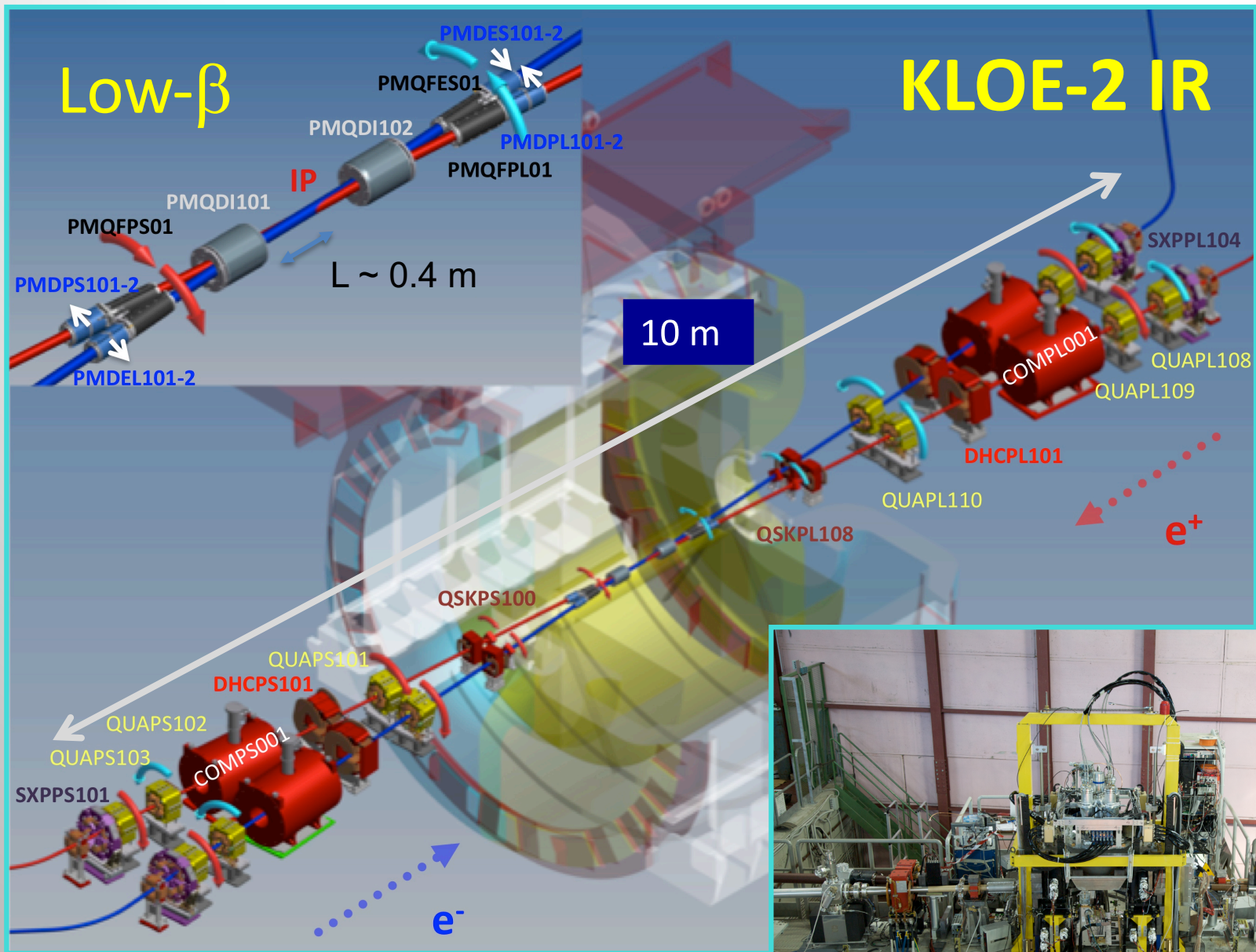

C. Milardi *et al* 2012 JINST 7 T03002.



SIDDHARTA IR

Betatron Coupling correction

$\int_{KLOE} B \cdot dl$ canceled by 2 anti-solenoids for each beam

$$\int_{KLOE} B \cdot dl = 2.048 \quad [Tm] \quad \rightarrow \quad I_{KLOE} = 2300. [A]$$

$$\int_{comp} B \cdot dl = \pm 1.024 \quad [Tm] \quad \rightarrow \quad I_{comp} = 86.7 [A]$$

In order to have coupling compensation also for off-energy particles

Fixed QUAD rotations

K is expected to be lower than for KLOE past

$$K_{KLOE1} = 0.2 \div 0.3 \%$$

	Z from the IP [m]	Quadrupole rotation angles [deg] <i>Anti-solenoid current [A]</i>
PMQDI101	0.415	0.0
PMQFPS01	0.963	-4.48
QSKPS100	2.634	used for fine tuning
QUAPS101	4.438	-13.73
QUAPS102	8.219	0.906
QUAPS103	8.981	-0.906
COMPS001	6.963	72.48 (optimal value 86.7)

C. Milardi et al 2012 JINST 7 T03002.

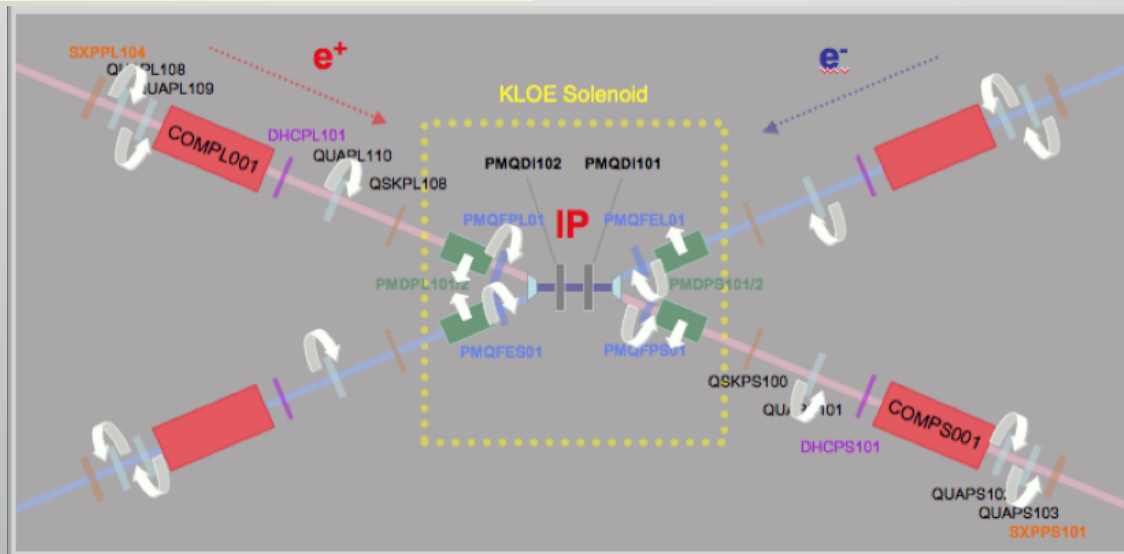

DAΦNE Activity Program for KLOE-2

Preliminary Test Phase

fall 2010 ÷ Dec 2012

Collider Consolidation

KLOE-2 detector layers installed *Dec 2012 ÷ Jun 2013*

KLOE-2 data taking

I Run *Nov 16th 2014 ÷ Jul 3rd 2015*

goal 1 fb^{-1}

II Run *Spt 28th 2015 ÷ Jun 29th 2016*

goal 1.5 fb^{-1}

III Run *Spt 12nd 2016 ÷ Aug 1st 2017*

goal 2 fb^{-1}

IV Run *Spt 6th 2017 ÷ Mar 31st 2018*

goal 1.5 fb^{-1}

KLOE-2 Run Overview

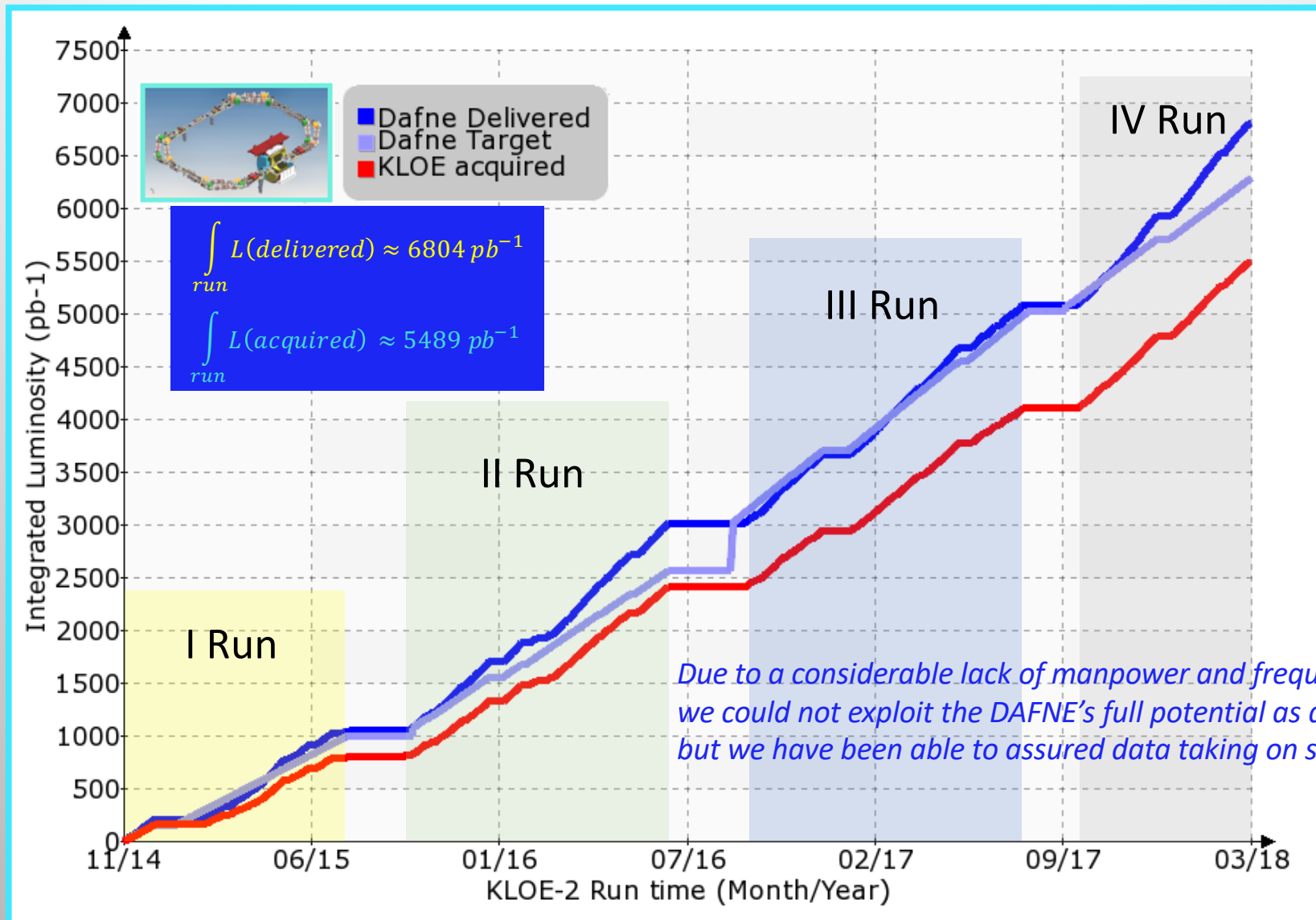

Crab-Waist Luminosity Gain

Crab-Waist provides a 59% increase in terms of peak luminosity as evidenced by data taken by the same detector with the same accuracy

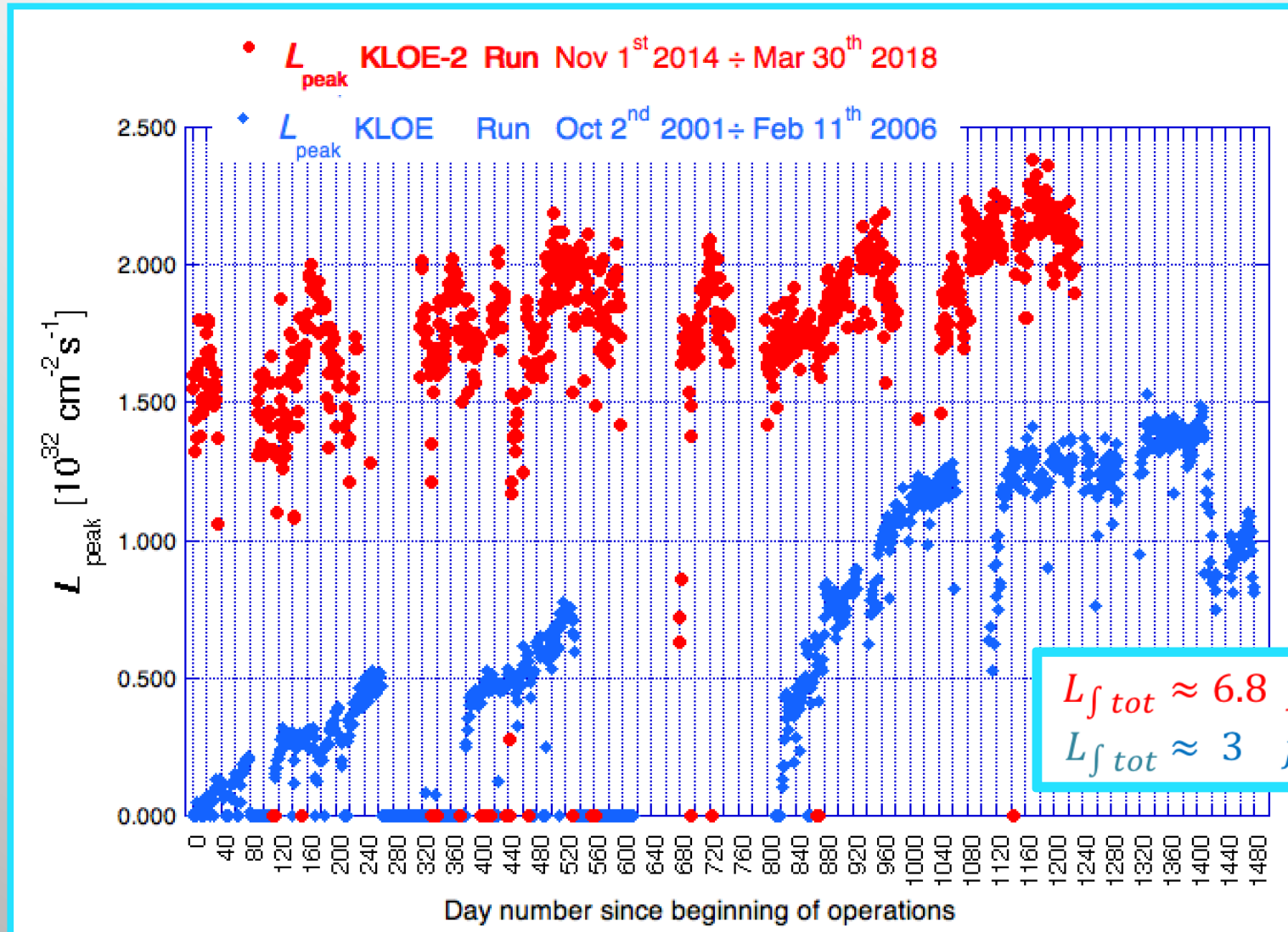

Crab-Waist Interaction Region for SIDDHARTA-2 Run

PMQs specifications

New PMQs are Halbach type magnets made of SmCo_{2:17}
 PMQs have been designed in collaboration with the ESRF magnet group.

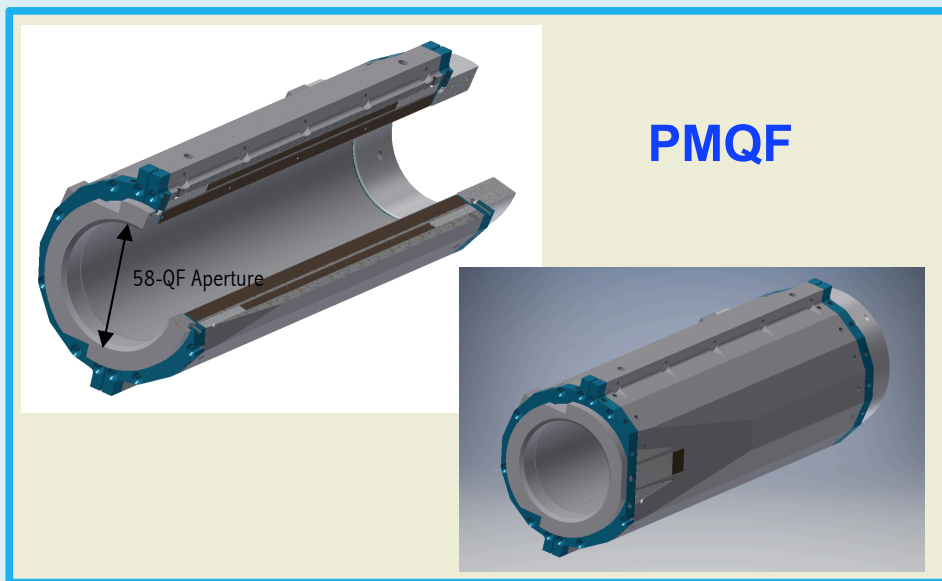
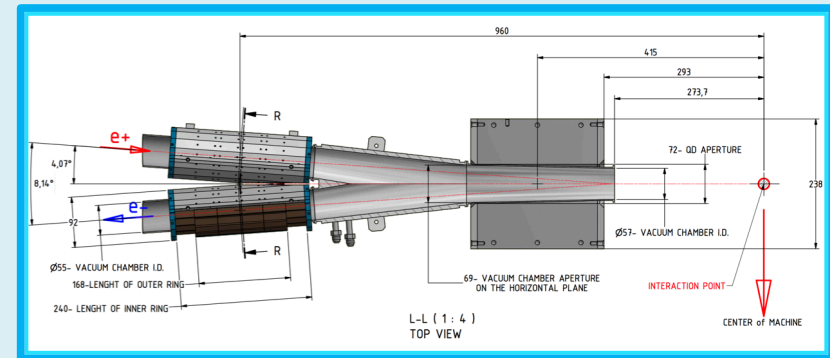
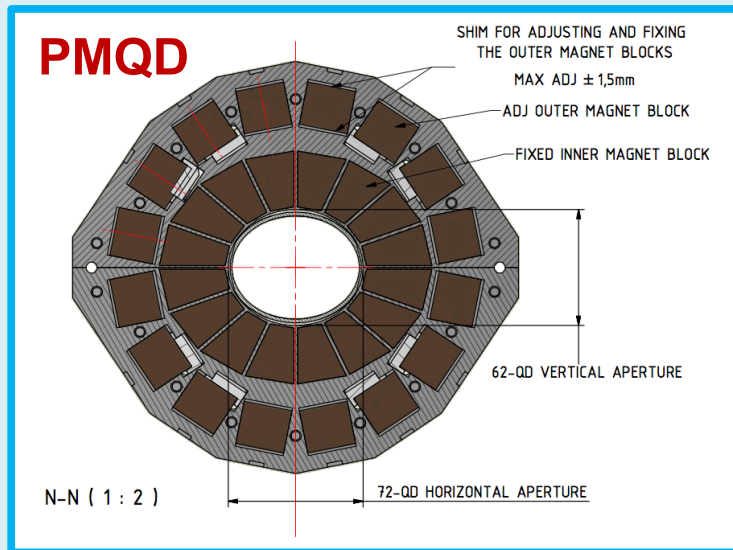

	PMQD	PMQF
Beam Pipe Aperture H-V (mm) at IP (I row) and at Y (II row) side	57 69 - 55	54
Inner Apert. With Case H-V (mm)	72 - 62	58
Outer Diameter H-V (mm)	238 - 220	95.6
Mech. Length Inner-Outer (mm)	220	168 - 240
Nominal Gradient (T/m)	29.2	12.6
Integrated Gradient (T)	6.7	3.0
Good Field Region (mm)	±20	±20
Integrated Field Quality dB/B	5.00E-4	5.00E-4
Magnet Assembly	2 halves	2 halves

DAΦNE IR and SIDDHARTA-2



Conclusions

DAFNE is the first and only Collider running with the *Crab-Waist* Collision Scheme, presently the third different detector is preparing to take data.

The new collision scheme including Large Piwinski angle and Crab-Waist compensation of the beam-beam interactions has proved to be a viable approach to increase the luminosity

- *It has been successfully tested and routinely used during the SIDDHARTA run when a factor ~ 3 higher instantaneous luminosity has been measured*
- *Crab-Waist collision scheme has also been the leading concept in designing the new IR for the KLOE-2 experiment. KLOE-2 data-taking profited from a daily integrated luminosity comparable with the best ever measured at DAFNE, despite the instantaneous luminosity gain was a factor 2 lower wrt the one measured with the SIDDHARTA configuration. NO TIME for MD!*
- *KLOE-2 run has clearly stated the Crab-Waist collision scheme effectiveness even in presence of a large detector including high intensity longitudinal field at low energy colliding beams*
- *Presently DAFNE operations are finalized to provide data to the SIDDHARTA-2 experiment.*

Crab-Waist Colliders

Colliders	Location	Status
DAΦNE	Φ-Factory Frascati, Italy	In operation (SIDDHARTA, KLOE-2, SIDDHARTA-2)
SuperKEKB	B-Factory Tsukuba, Japan	Adoped CW collision Scheme few years ago
SuperC-Tau	C-Tau-Factory Novosibirsk, Russia	Russian mega-science project
FCC-ee	Z,W,H,tt-Factory CERN,Switzerland	100 km, CDR
CEPC	Z,W,H,tt-Factory China	100 km, CDR released in September 2018
HIERA	2-7 GeV China	Considered option

.... let me joke

M. Schulz

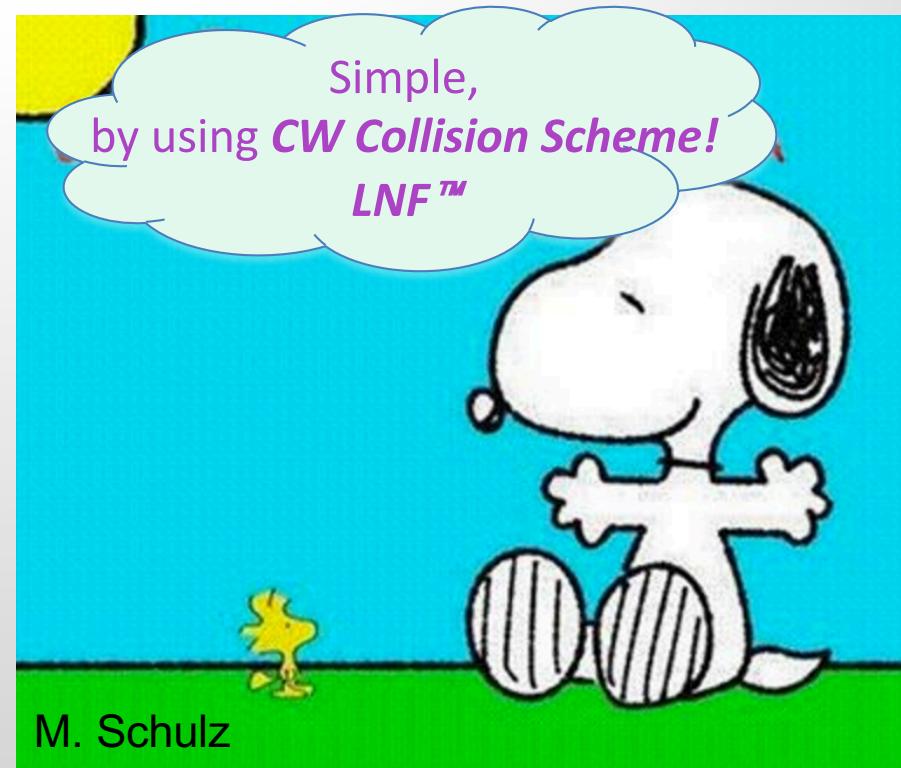
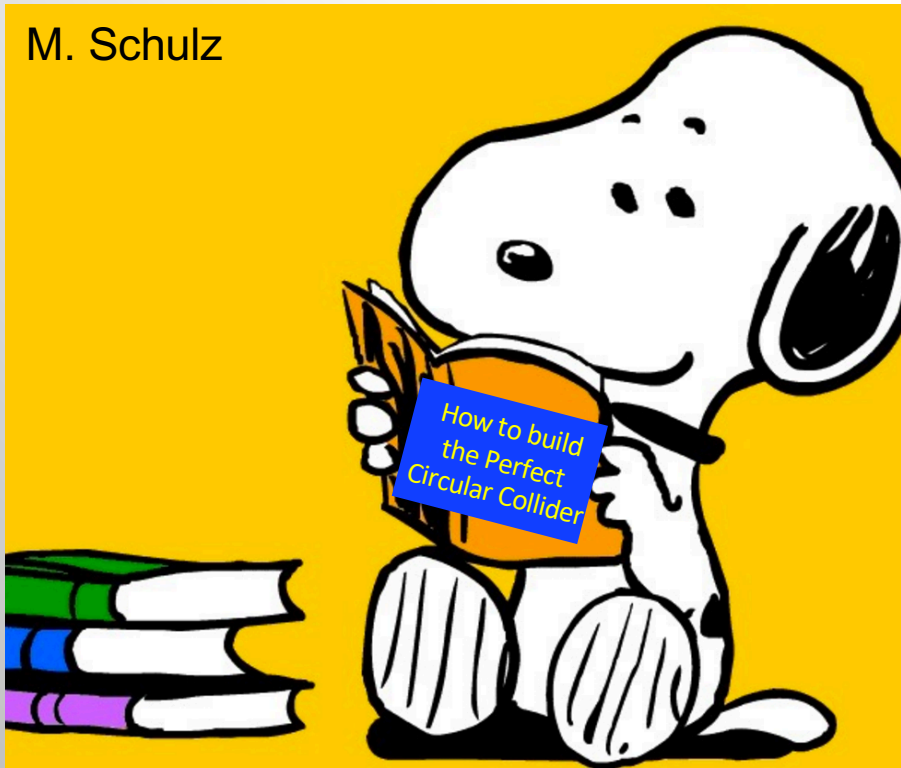

Thank you for your attention

Spare Slides

Betatron Tune

One defines the tune per lattice as :

$$Q = \frac{\bar{\mu}}{2\pi} = \frac{1}{2\pi} \oint \frac{ds}{\beta(s)}$$

In synchrotron, the **tune** is the number of betatron oscillations over one turn.

Resonance : $n_x \cdot Q_x + n_y \cdot Q_y = n$

Resonance' s order : $|n_x| + |n_y|$

Avoid resonances :
find the best working point in tune
diagram

