

High energy resolution x-ray detectors for IAXO: advantages in pre- and post-discovery phases

Loredana Gastaldo

Kirchhoff Institute for Physics
Heidelberg University

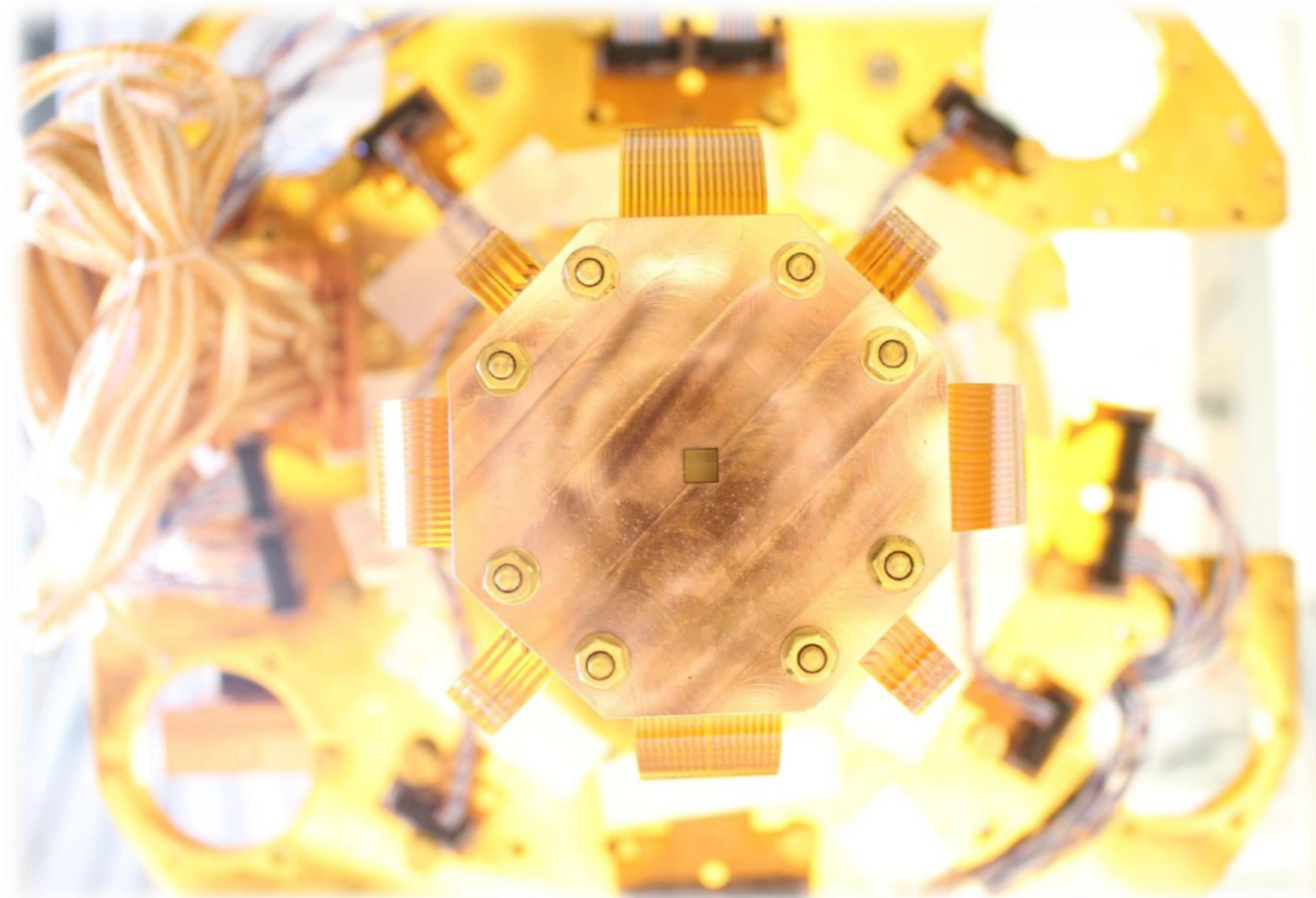

Outline

- Helioscope

 - Overview

 - IAXO

 - Post detection

- Metallic magnetic calorimeter for IAXO

 - Basic concepts

 - First results

- Conclusions

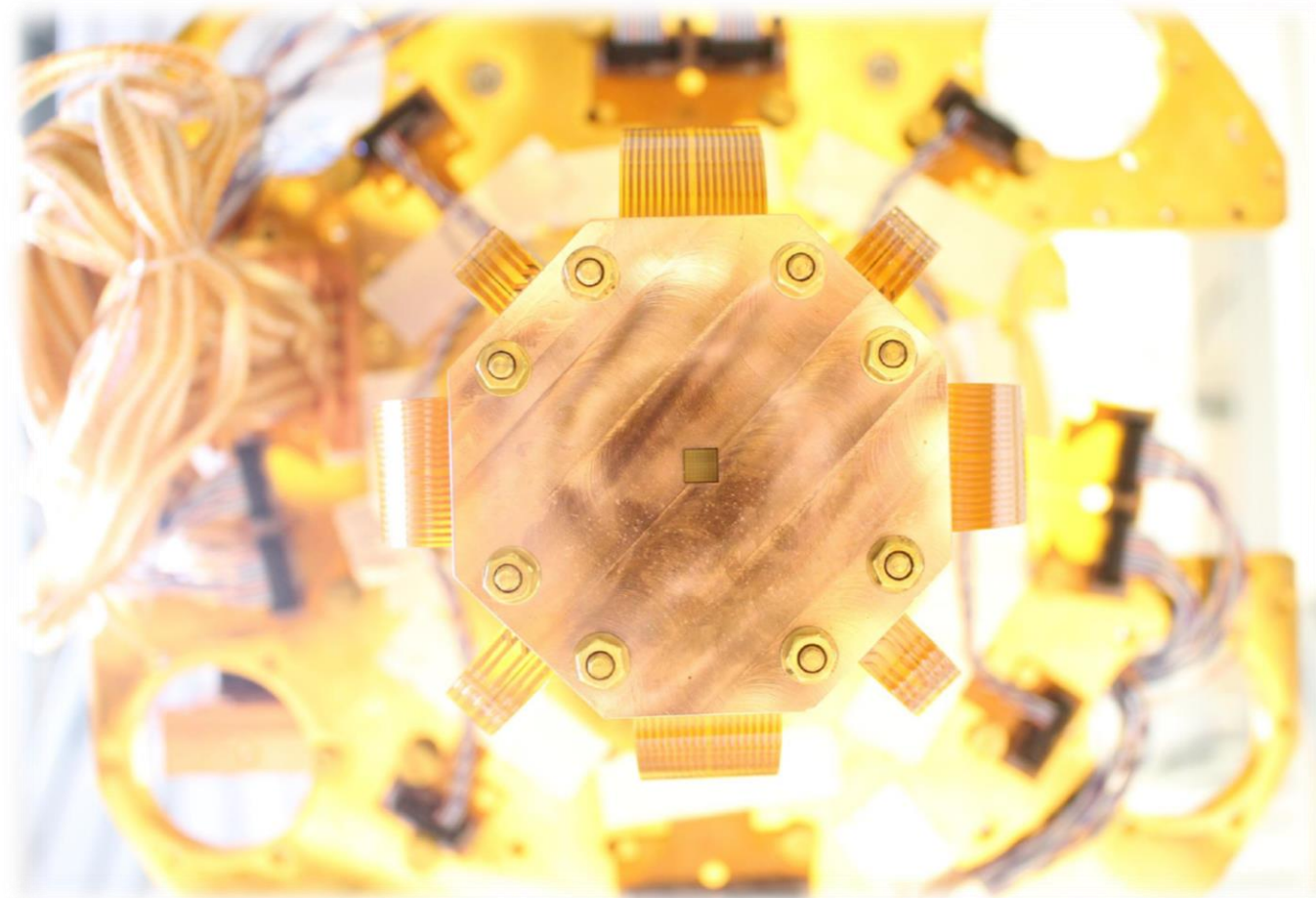

Solar Axions in Helioscope

Search for an evidence for solar axions

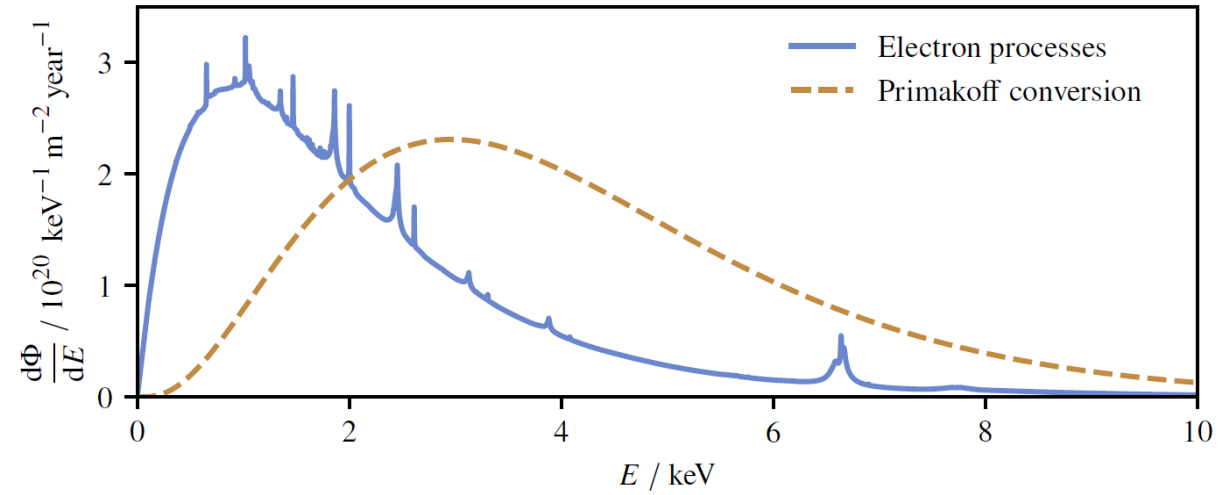
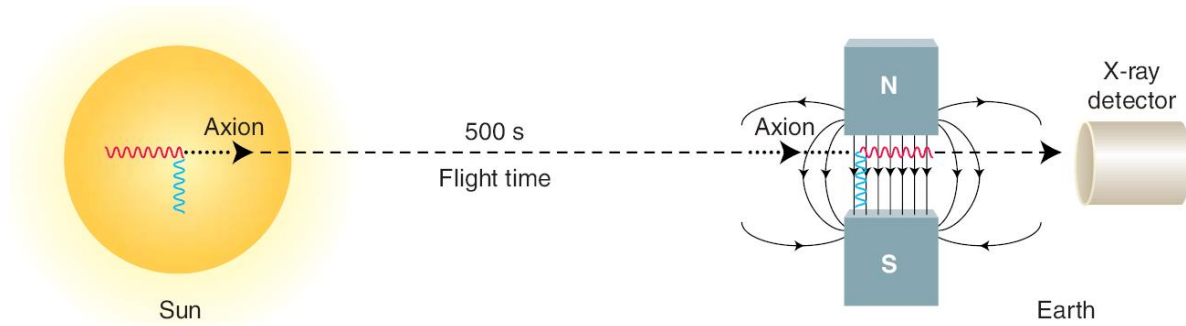

$$g_{a\gamma}^4 \propto \underbrace{b^{1/2} \epsilon^{-1}}_{\text{detectors}} \times \underbrace{a^{1/2} \epsilon_o^{-1}}_{\text{optics}} \times \underbrace{(BL)^{-2} A^{-1}}_{\text{magnet}} \times \underbrace{t^{-1/2}}_{\text{exposure}}$$

Low background and high efficiency x-ray detectors

CAST

3rd generation: CERN Axion Solar Telescope (CAST)

- Most sensitive axion helioscope to date (10m, 9T)
- Best experimental limit on axion-photon coupling over broad axion mass range

$$g_{a\gamma} < 0.66 \times 10^{-10} \text{ GeV}^{-1} \text{ (95\% C.L.)}$$

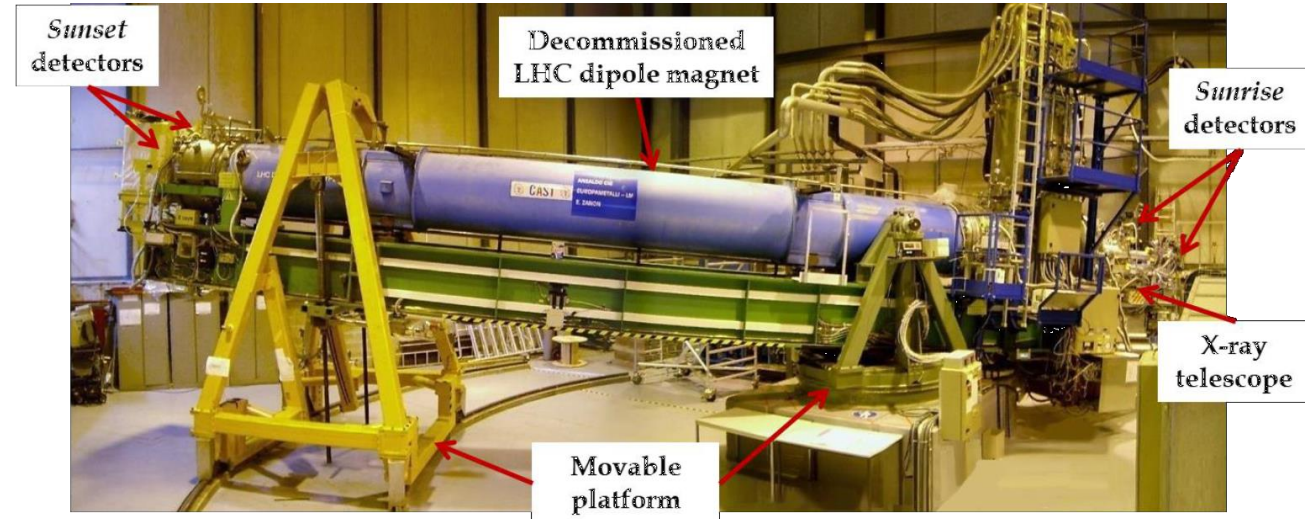
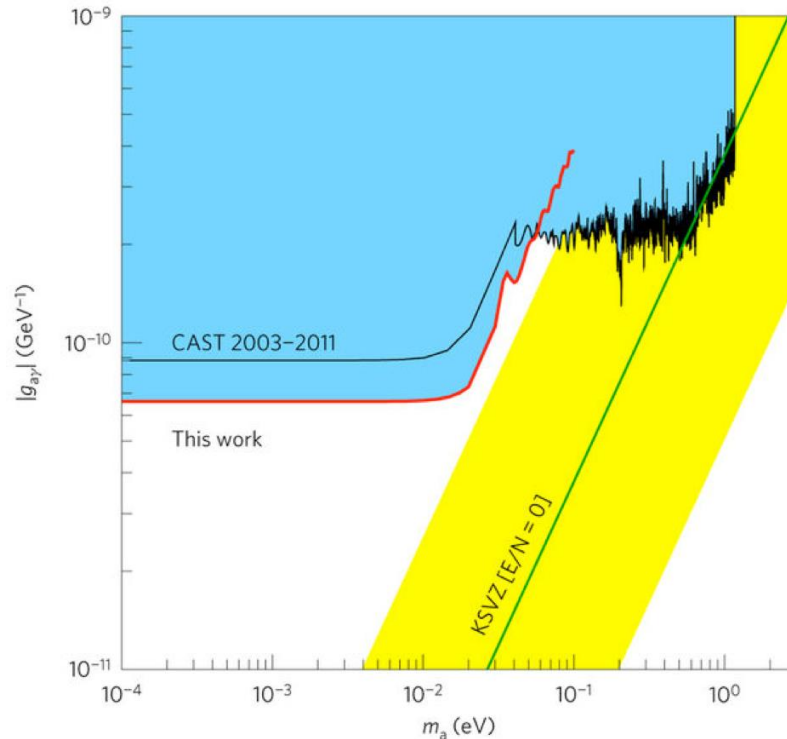

More tomorrow by [Serkant Cetin's talk](#)
"CAST and more than CAST; A Dark Sector
Probe for 20+ Years"

IAXO

IAXO-The International Axion Observatory

IAXO aims to improve CAST sensitivity to solar axions in 1 order of magnitude!

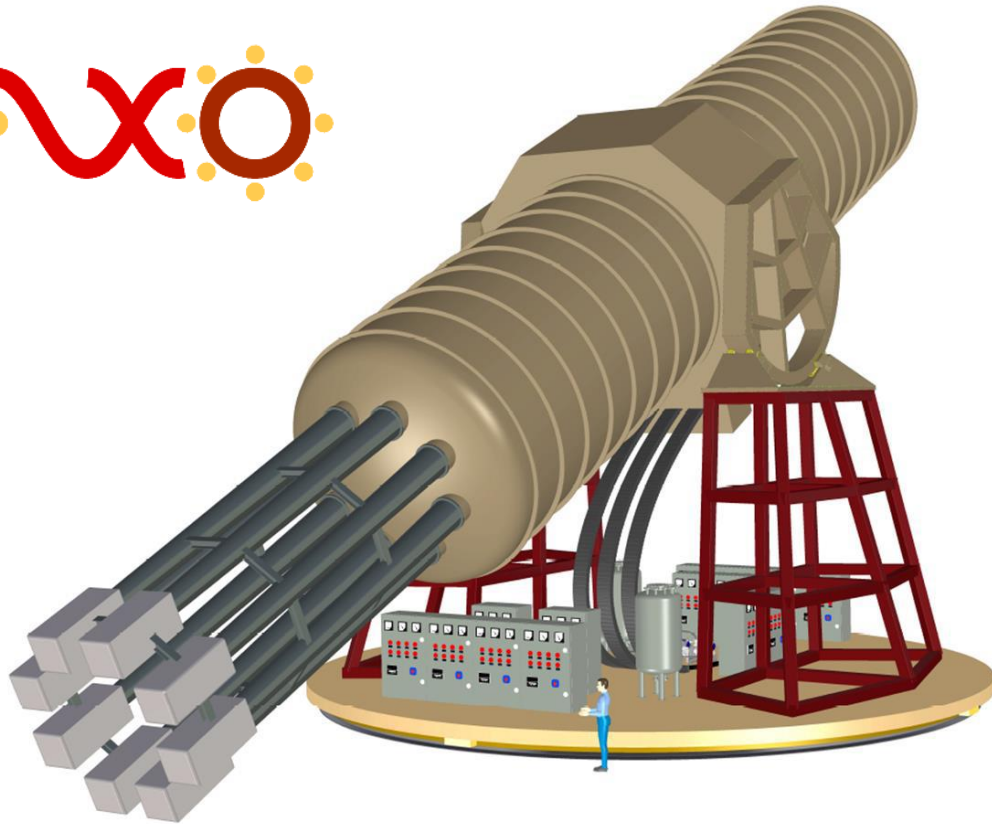

Super toroidal magnet

- 20 meters long
- Magnetic field up to 5.4 T
- 8 bores of 60 cm \varnothing

Dedicated X-ray optics

- 0.2 cm² focal spot

Tracking system

- Based on gamma ray telescopes
- 50% of Sun-tracking time

X-ray detector technologies

- Micromegas
- GridPix
- Metallic Magnetic Calorimeters (MMC)
- Transition Edge Sensors (TES)
- Silicon Drift Detectors (SDD)

Baby-IAXO

Baby-IAXO is currently under construction at DESY!

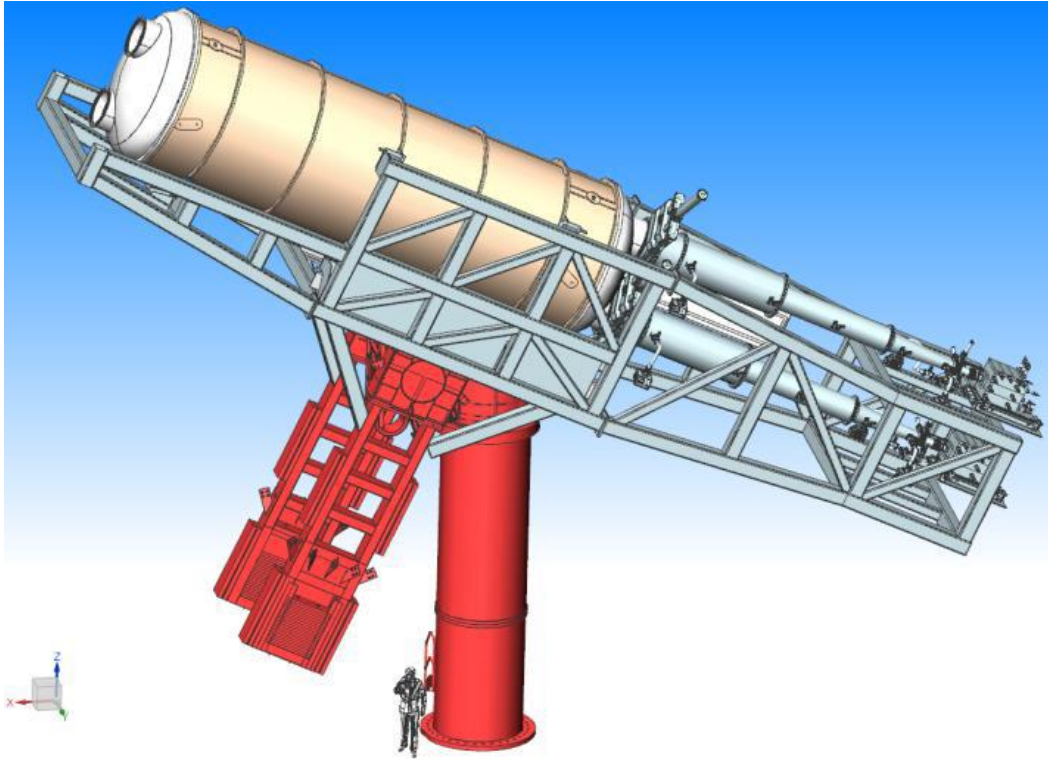

Dipole magnet

- 10 meters long
- Magnetic field ~ 2 T
- 2 bores of 70 cm \varnothing

Dedicated X-ray optics

- 0.2 cm² focal spot

Tracking system

- Based on gamma ray telescopes

X-ray detector technologies

- Micromegas (baseline)

IAXO & baby-IAXO: Sensitivity Perspectives

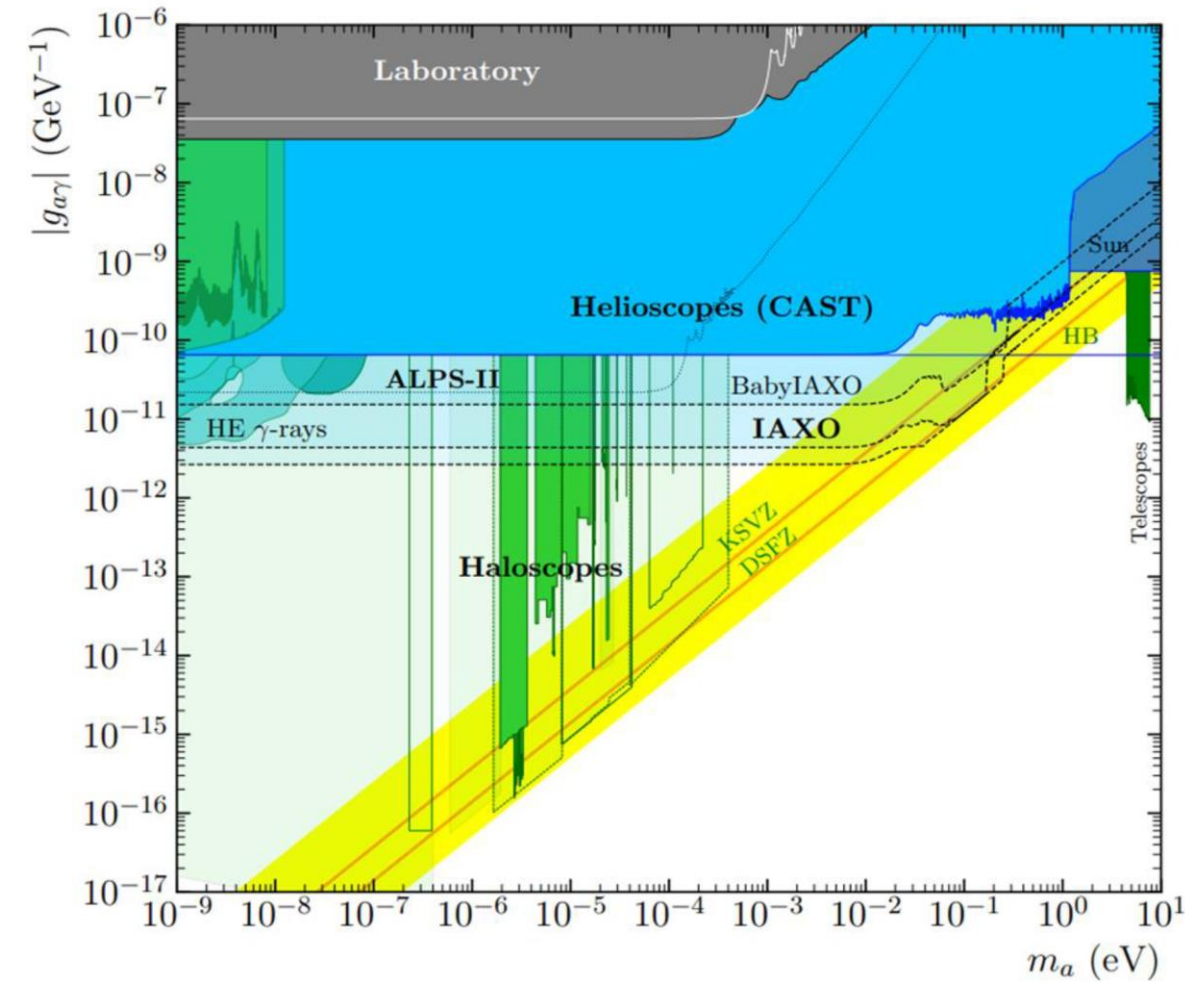

BabyIAXO will be sensitive to realistic QCD axion models!

IAXO will improve CAST sensitivity in more than a factor 10

Further physics potential of (Baby)IAXO:

- Axion-electron coupling
- Interesting ALPs parameter space
- Cold Dark Matter axions using the haloscope technique

Post-discovery investigation

Distinguishing Axion Models with IAXO

J. Jaeckel and L. J. Thormaehlen,
JCAP 03 (2019) 039

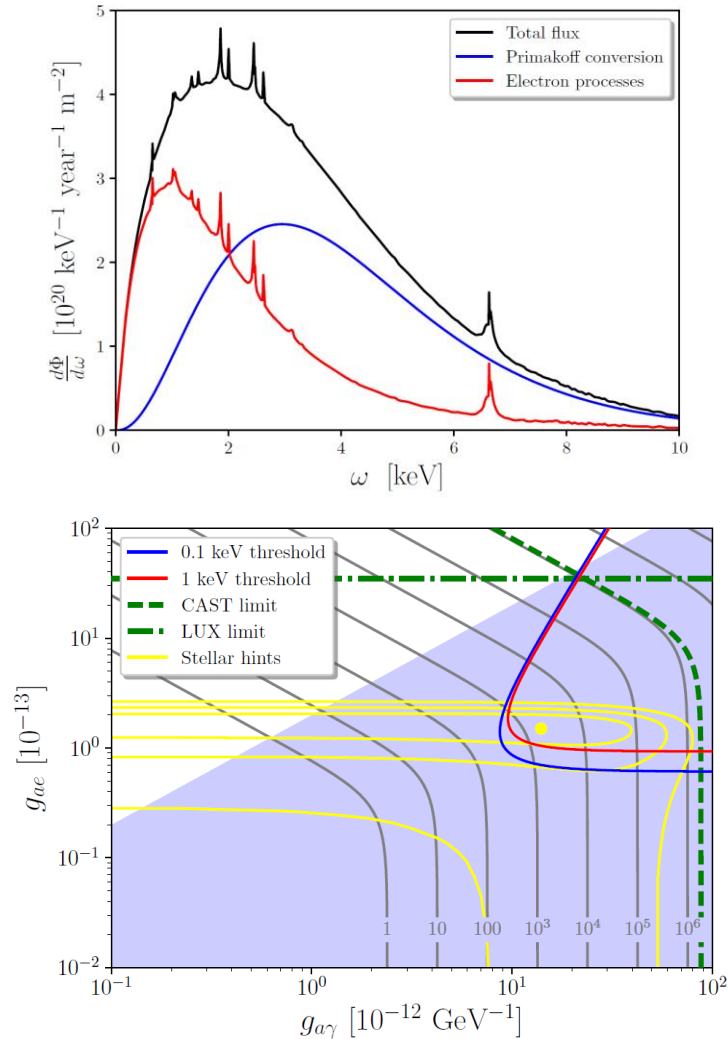

Solar metallicity

J. Jaeckel and L. J. Thormaehlen,
Phys. Rev. D 100, 123020 (2019)

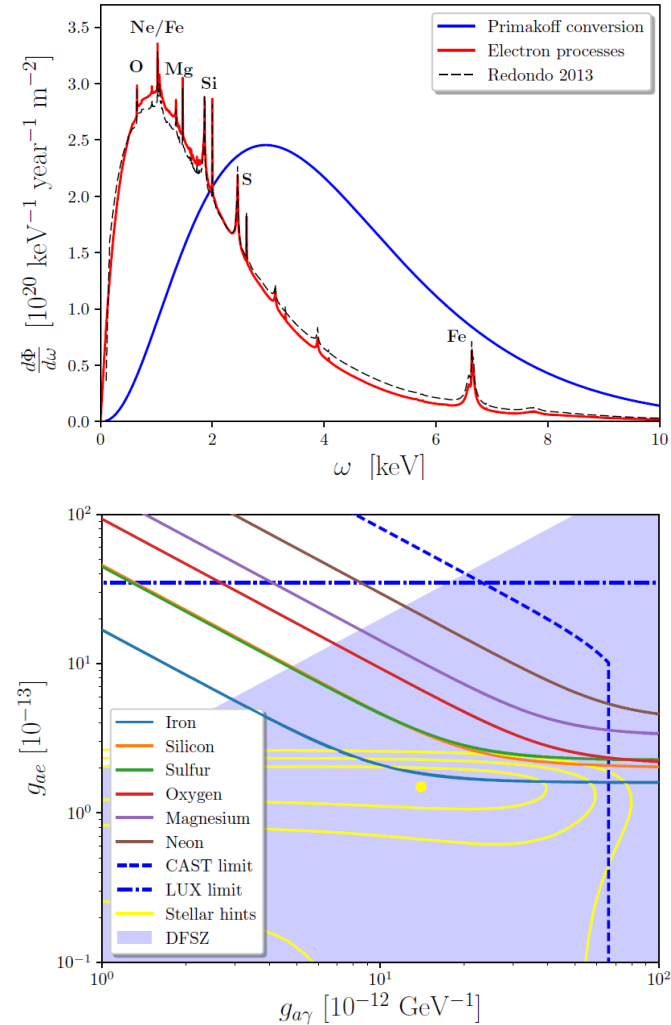

Post-discovery investigation

Weighing the Solar Axion

T. Dafni et al., Phys. Rev. D 99, 035037 (2019)

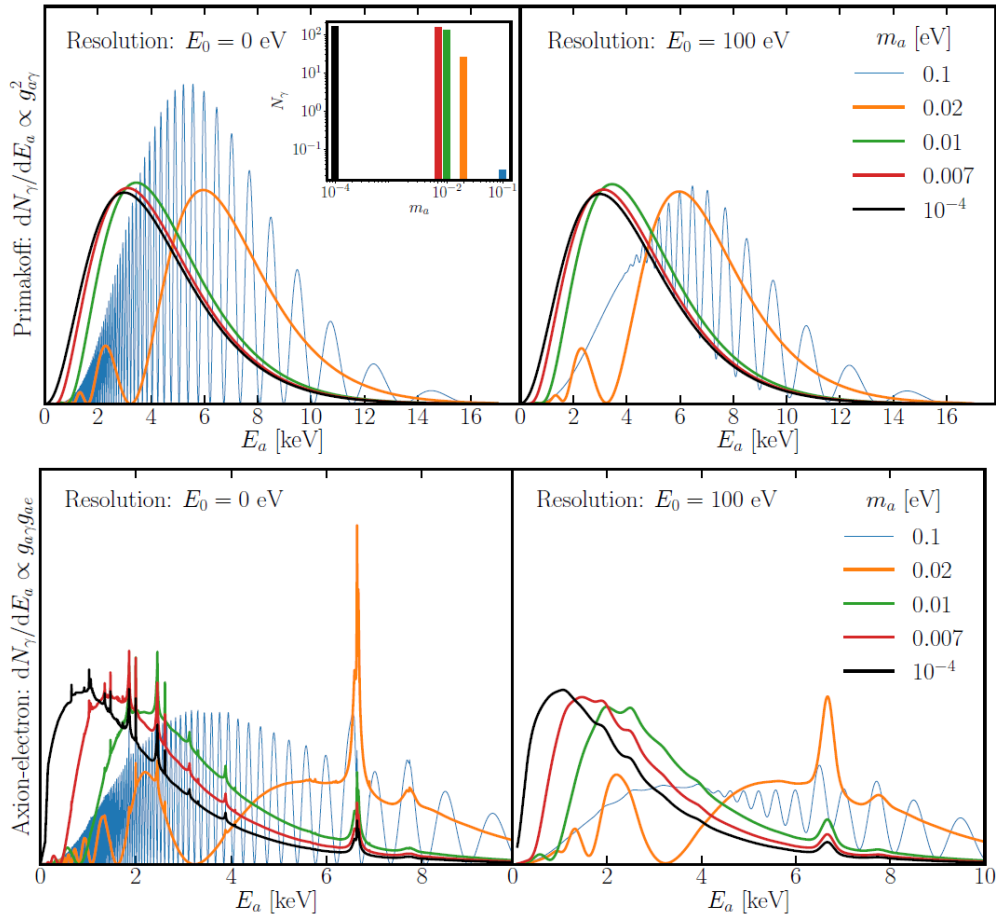

Probing the axion–nucleon coupling with the next generation of axion helioscopes

L. Di Luzio et al., EPJC 82 (2022) 120

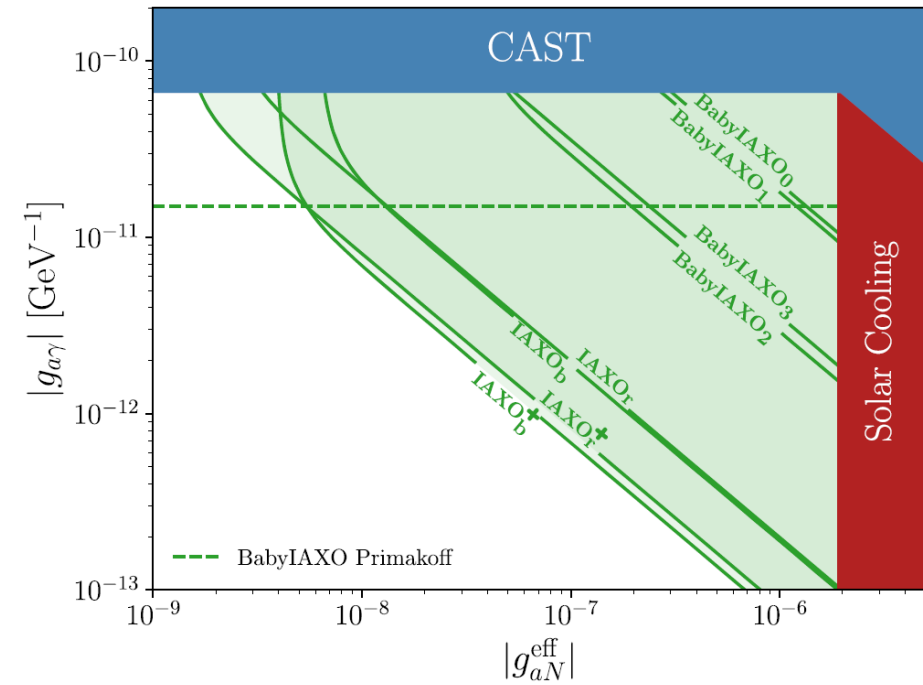

MMC for IAXO

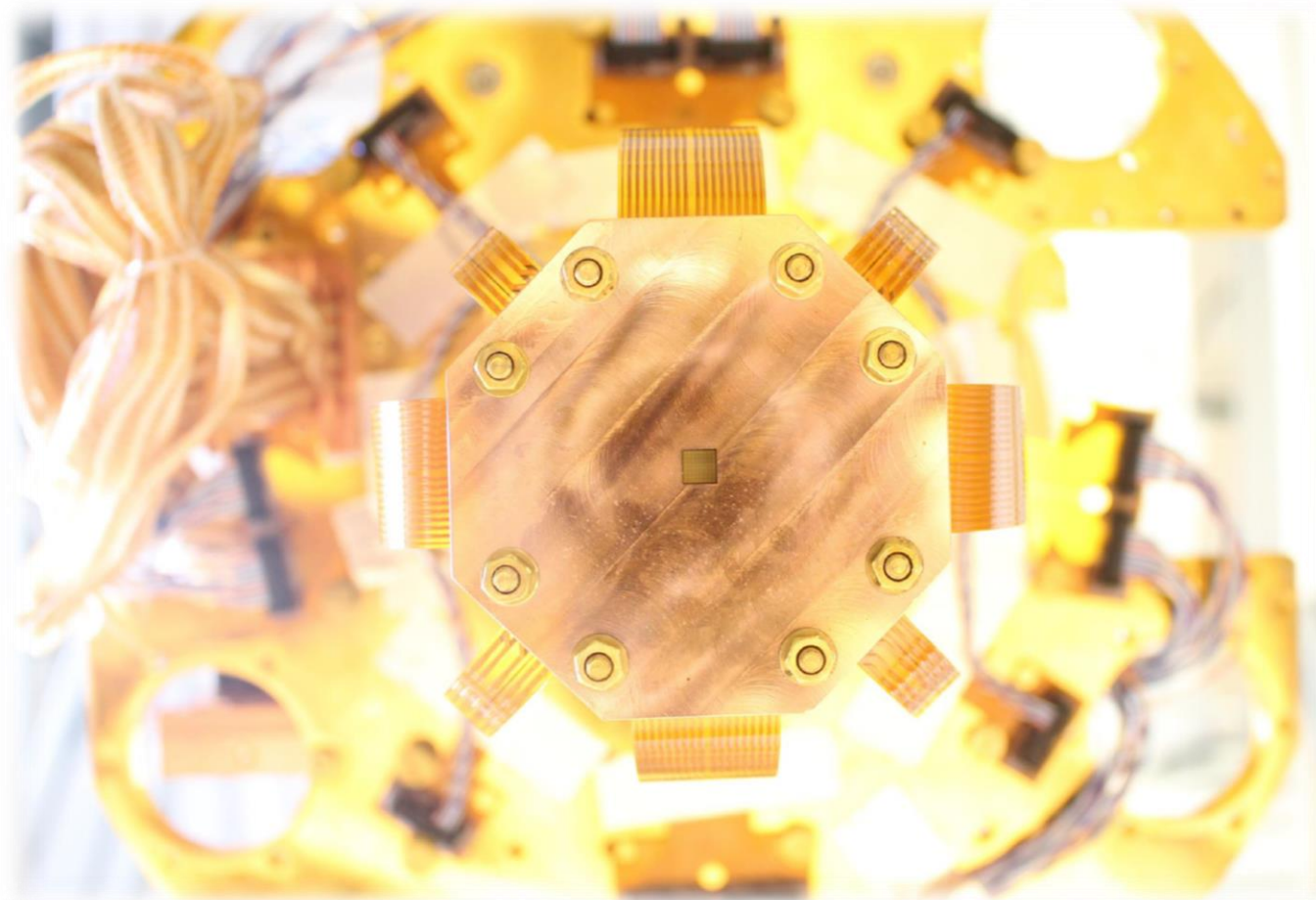

Low Temperature Calorimeters

Near equilibrium detectors

Energy deposition induces increase of temperature

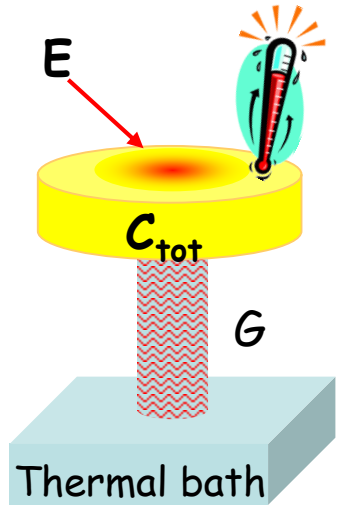

$$\Delta T \cong \frac{E}{C_{\text{tot}}}$$

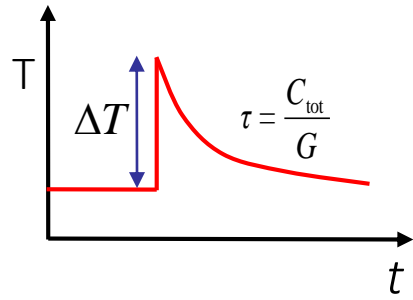

Low Temperature Calorimeters

Near equilibrium detectors

Energy deposition induces increase of temperature

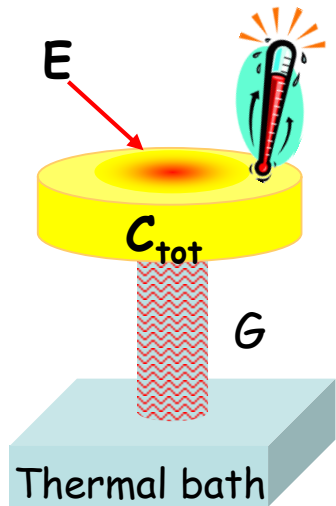

$$\Delta T \cong \frac{E}{C_{\text{tot}}}$$

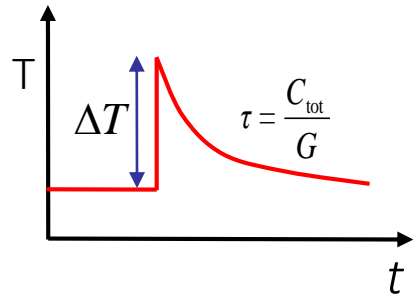

- Very small volume
- Working temperature below 100 mK
 - small specific heat
 - small thermal noise
- **Very sensitive temperature sensors**

Low Temperature Calorimeters

Near equilibrium detectors

Energy deposition induces increase of temperature

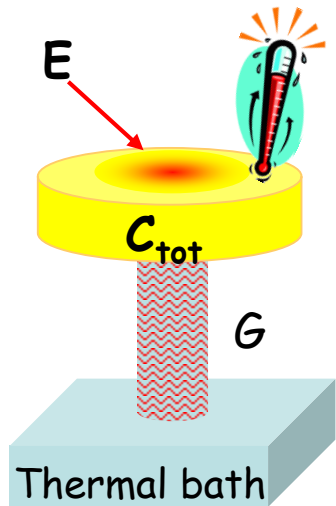

$$\Delta T \cong \frac{E}{C_{\text{tot}}}$$

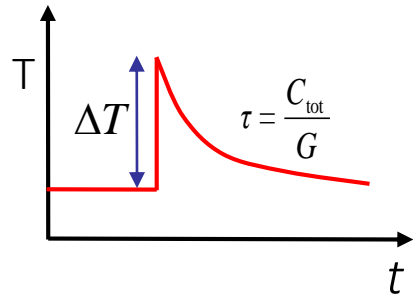

- Very small volume
- Working temperature below 100 mK
small specific heat
small thermal noise
- **Very sensitive temperature sensors**

Resistance of highly doped semiconductors

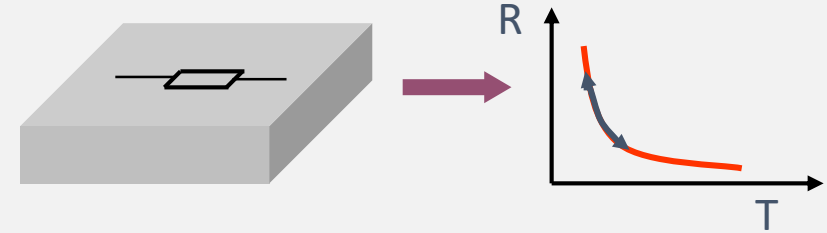

Resistance at superconducting transition, TES

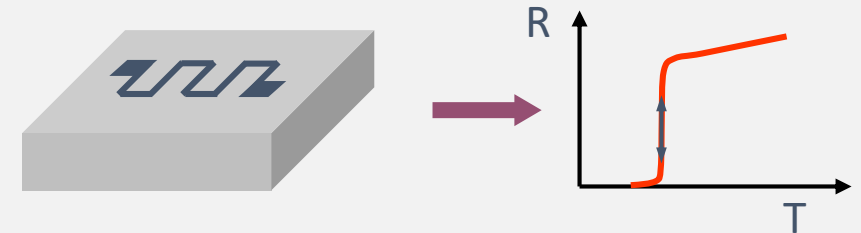

Magnetization of paramagnetic material, MMC



Metallic Magnetic Calorimeters

A.Fleischmann, C. Enss and G. M. Seidel,
Topics in Applied Physics **99** (2005) 63

A.Fleischmann et al.,
AIP Conf. Proc. **1185** (2009) 571

Paramagnetic temperature sensor

Dilute alloy Au:Er or Ag:Er (Er concentration: a few hundred ppm)

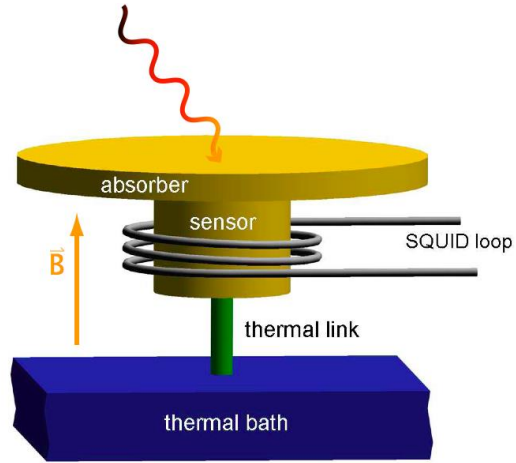

$$\Delta T \cong \frac{E}{C_{\text{tot}}}$$

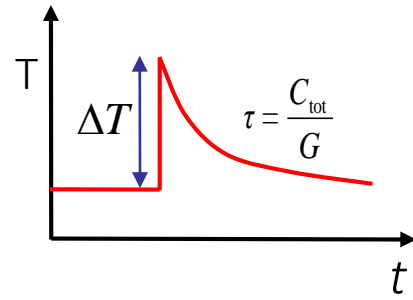

Metallic Magnetic Calorimeters

A.Fleischmann, C. Enss and G. M. Seidel,
Topics in Applied Physics **99** (2005) 63

A.Fleischmann et al.,
AIP Conf. Proc. **1185** (2009) 571

Paramagnetic temperature sensor

Dilute alloy Au:Er or Ag:Er (Er concentration: a few hundred ppm)

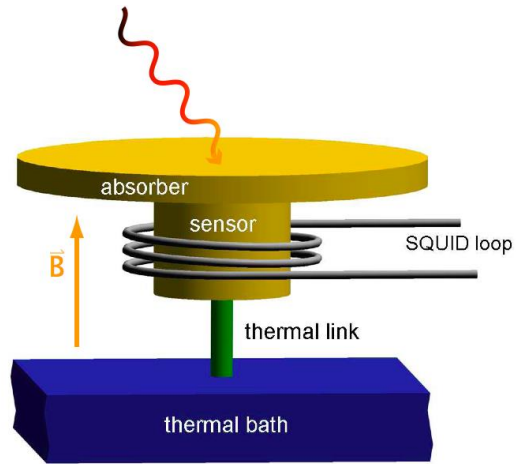

$$\Delta T \cong \frac{E}{C_{\text{tot}}} \xrightarrow{\text{MMC}} \Delta\Phi_s \propto \frac{\partial M}{\partial T} \Delta T \rightarrow \Delta\Phi_s \propto \frac{\partial M}{\partial T} \frac{E}{C_{\text{tot}}}$$

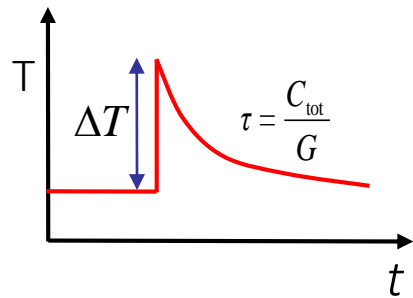

Metallic Magnetic Calorimeters

A.Fleischmann, C. Enss and G. M. Seidel,
Topics in Applied Physics **99** (2005) 63

A.Fleischmann et al.,
AIP Conf. Proc. **1185** (2009) 571

Paramagnetic temperature sensor

Dilute alloy Au:Er or Ag:Er (Er concentration: a few hundred ppm)

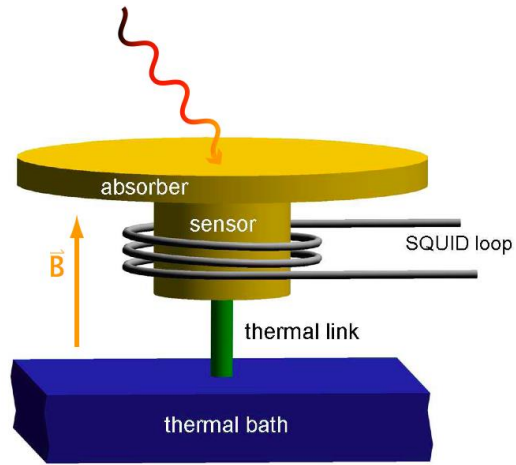

$$\Delta T \cong \frac{E}{C_{\text{tot}}} \xrightarrow{\text{MMC}} \Delta \Phi_s \propto \frac{\partial M}{\partial T} \Delta T \rightarrow \Delta \Phi_s \propto \frac{\partial M}{\partial T} \frac{E}{C_{\text{tot}}}$$

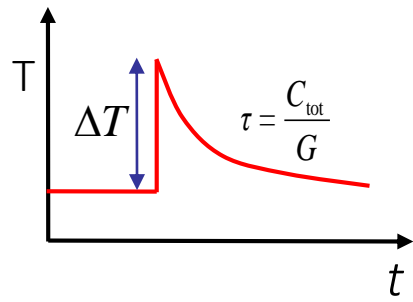

Very good agreement between data and theoretical expectation for interacting spin system

Optimization of detector geometries for wished applications

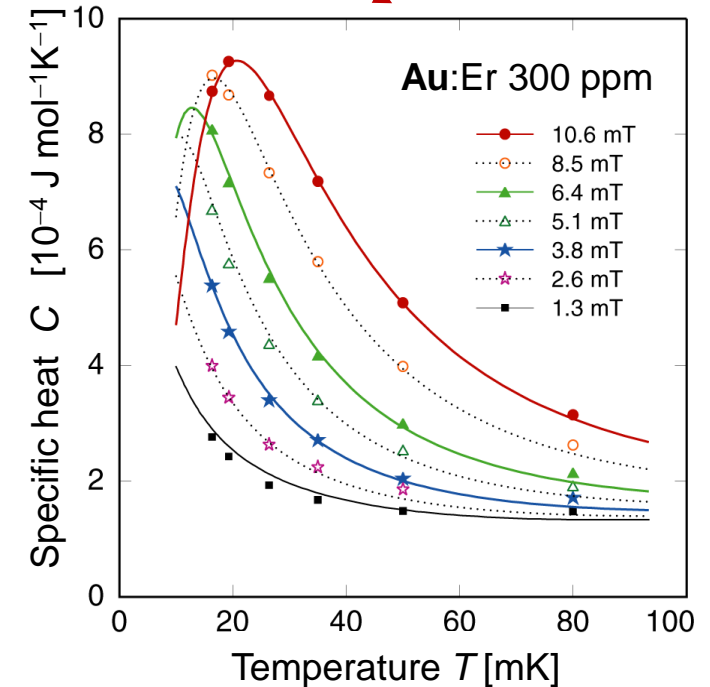
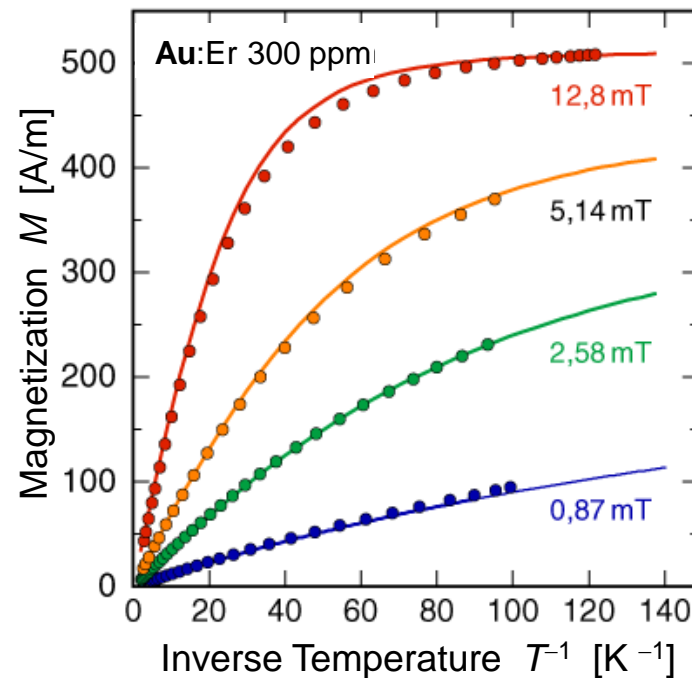

Detector geometries

- planar paramagnetic sensor
- superconducting coil
- transformed coupled to a dc SQUID

Well established:

- superconducting meander shaped pickup loop
- planar sensor on top of meander-shaped coil
- gradiometric design

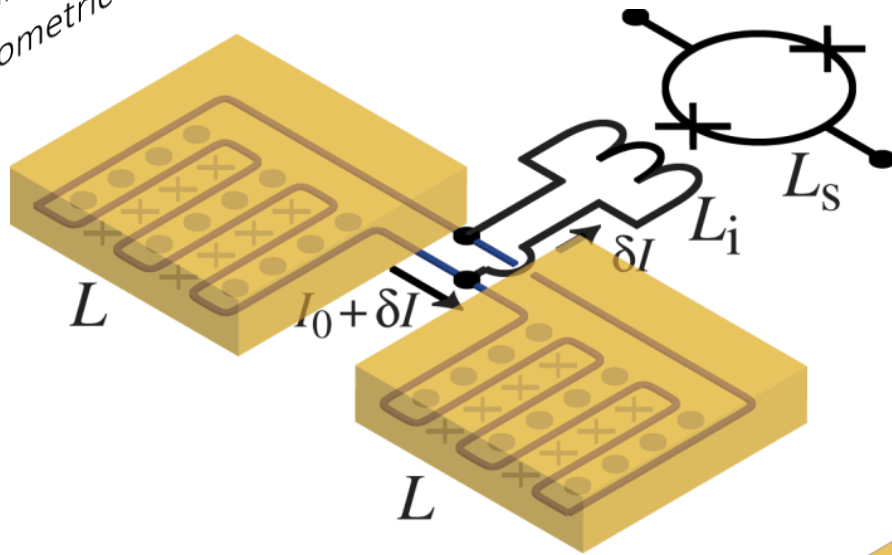

Sandwich geometry:

- planar sensor sandwiched between stripline
- best magnetic flux coupling

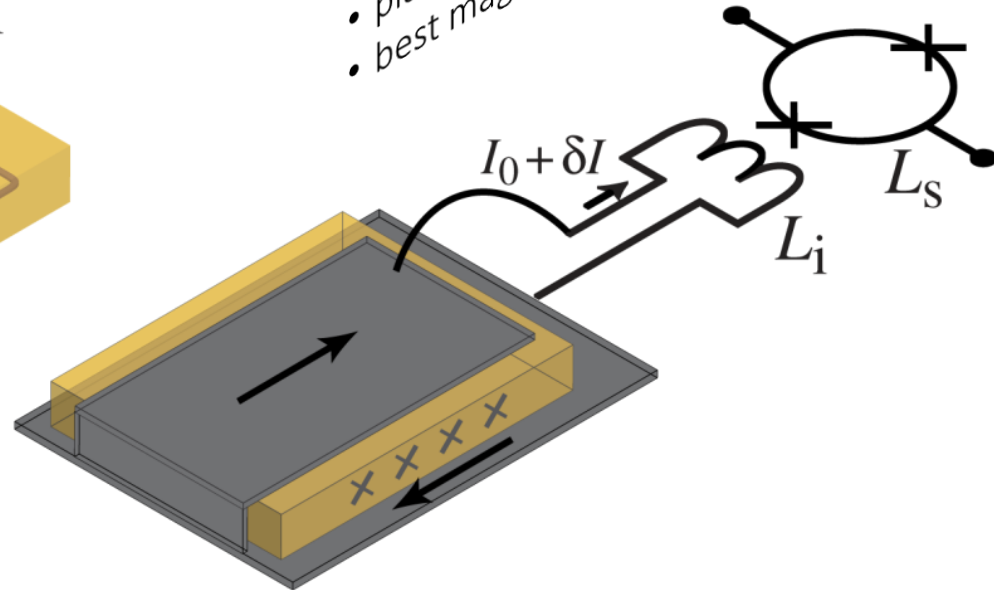

MMC readout

Two-stage dc-SQUID readout with flux-locked loop

low noise

small power dissipation on detector SQUID chip (voltage bias 1st stage)

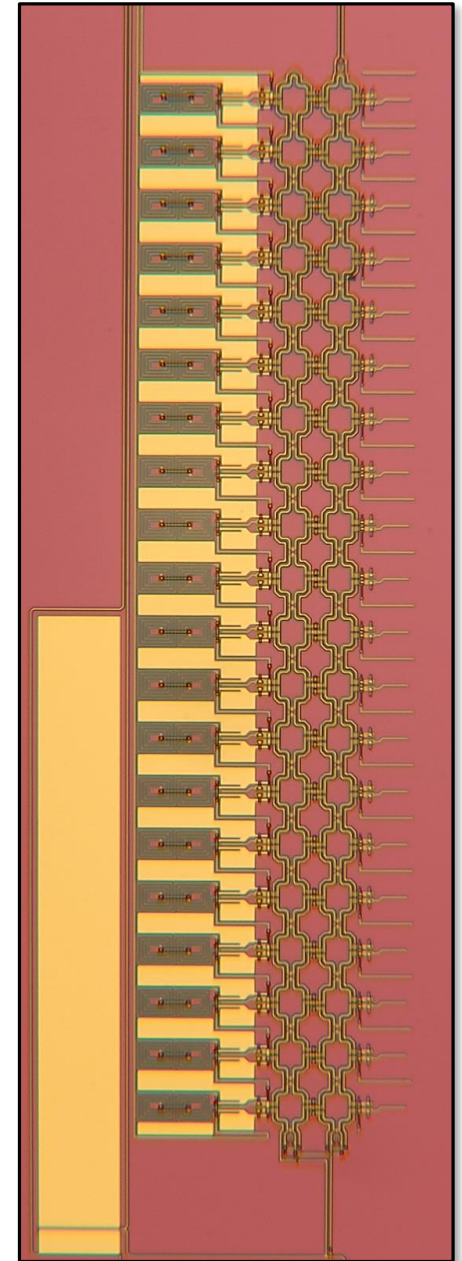
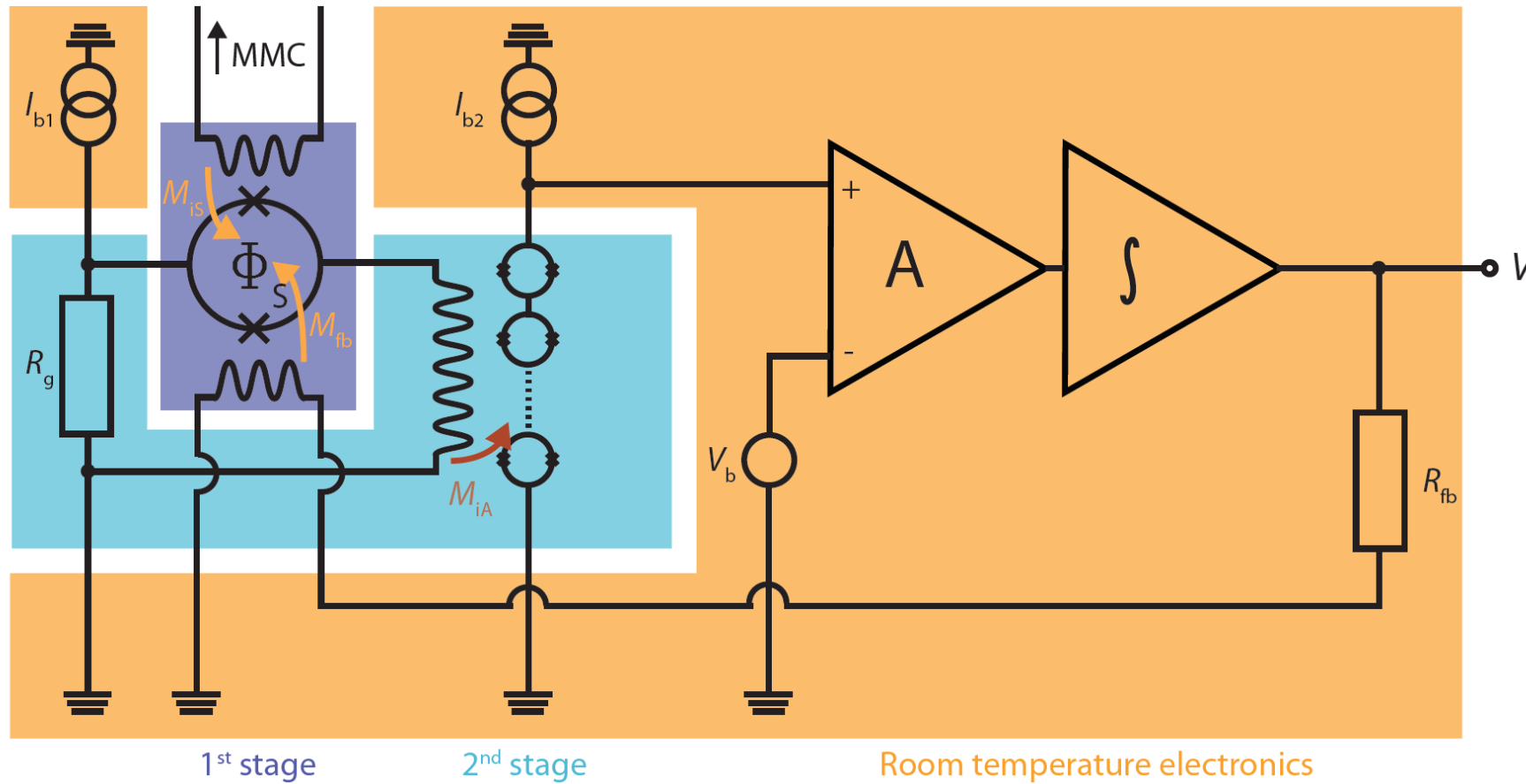

In house produced SQUID array

MMC readout

Detector module

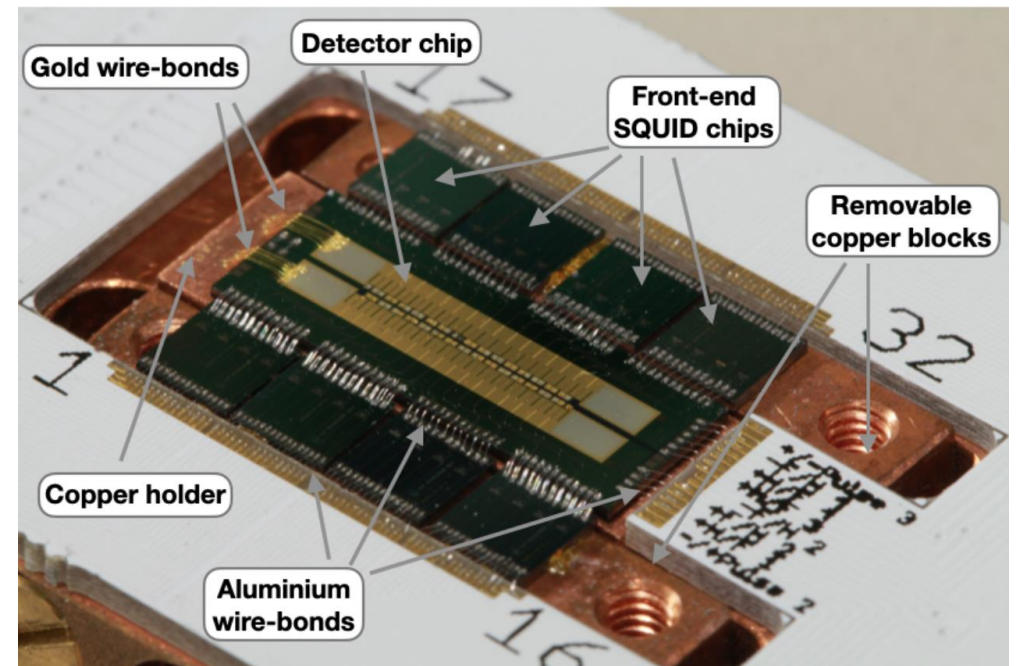

Amplifier module

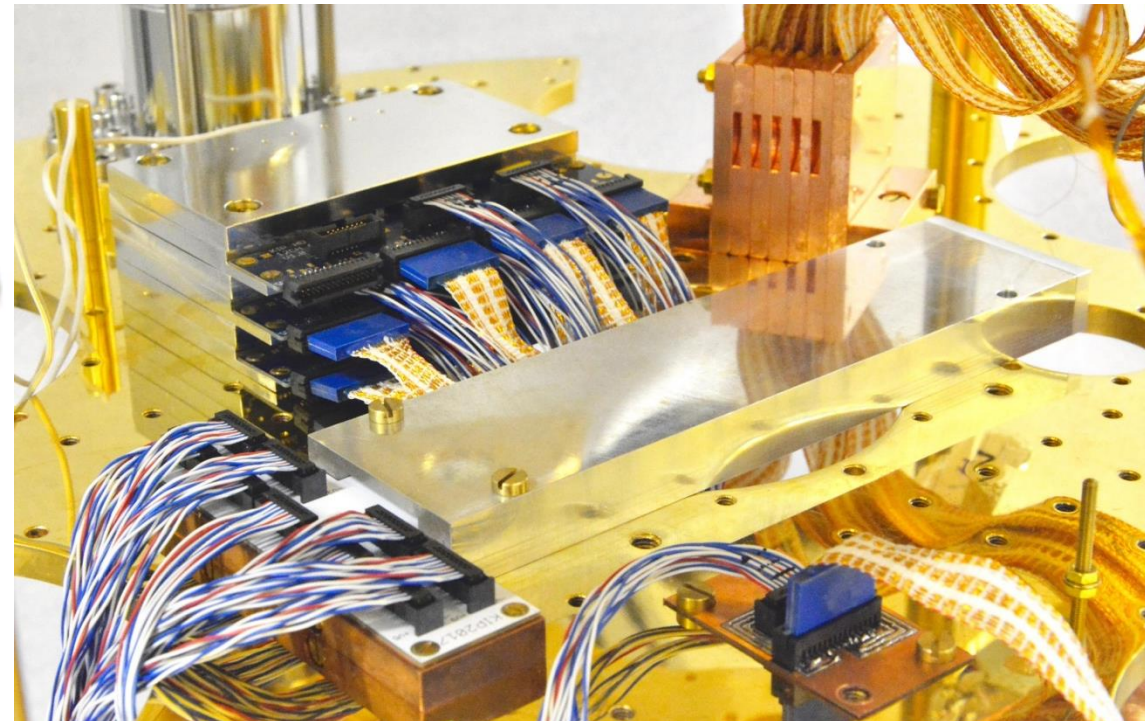
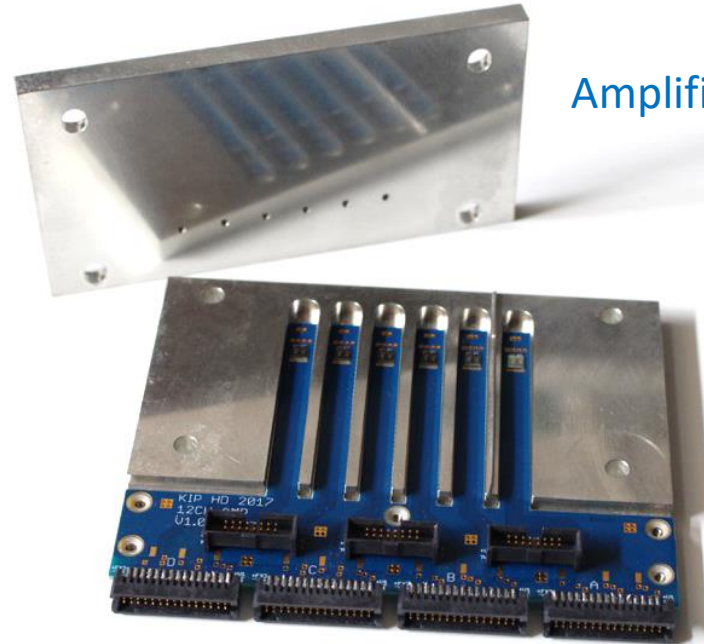

Detector and amplifier module mounted on the mixing chamber plate

MMC readout

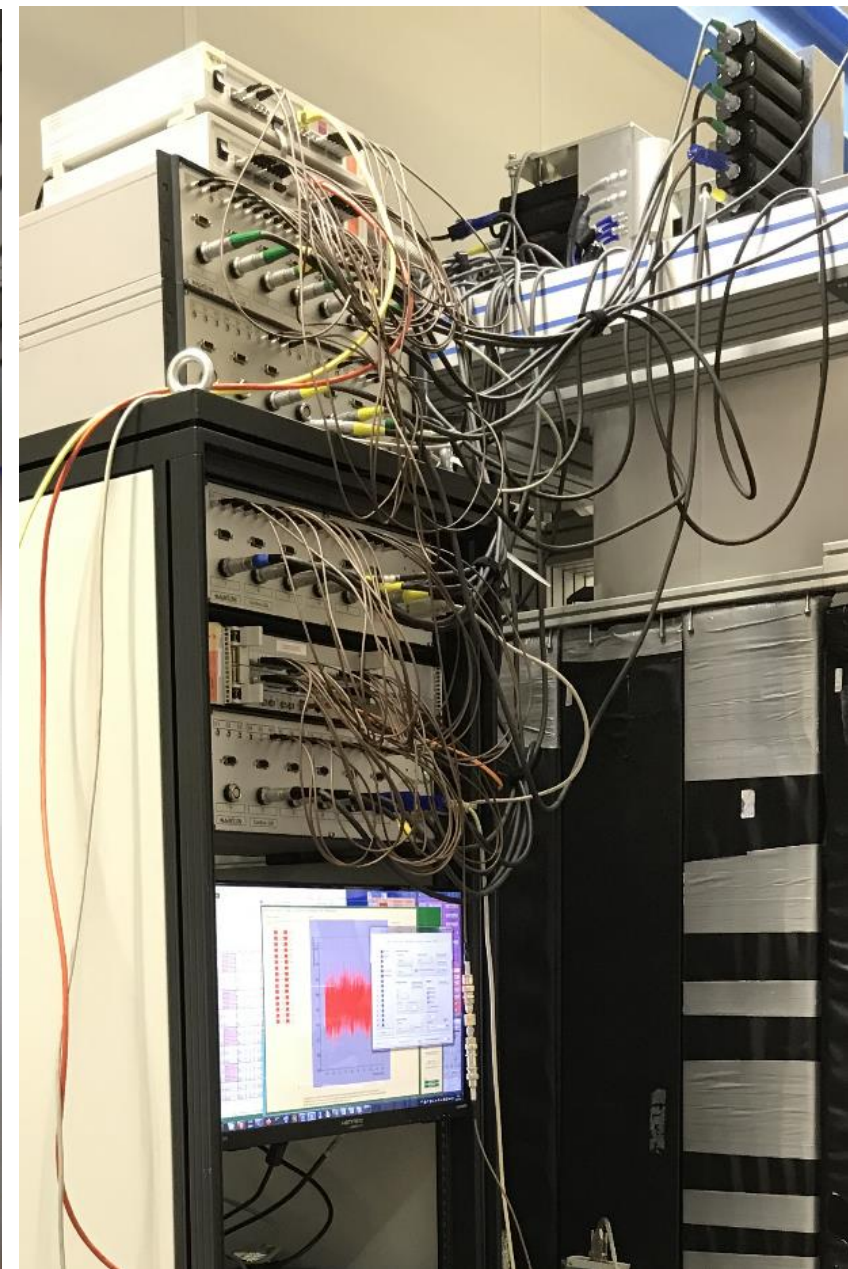
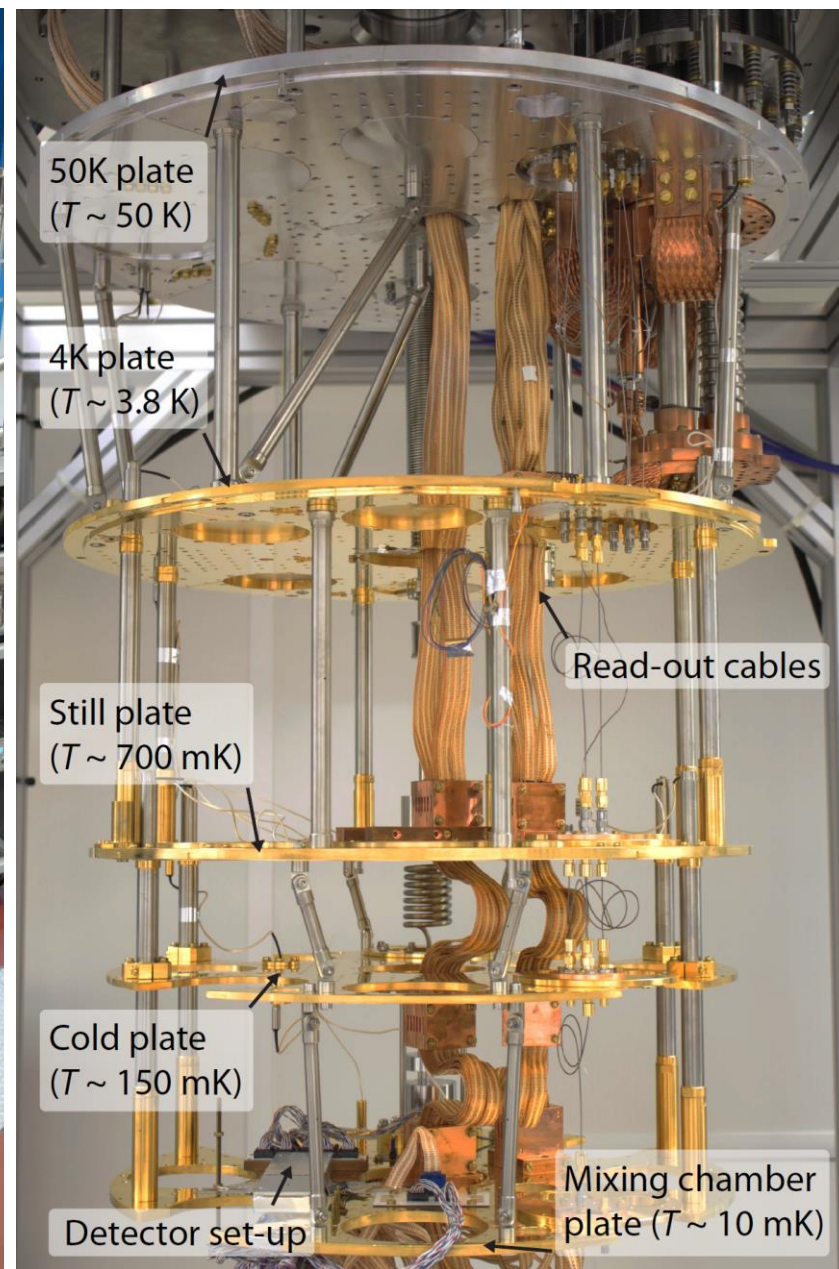
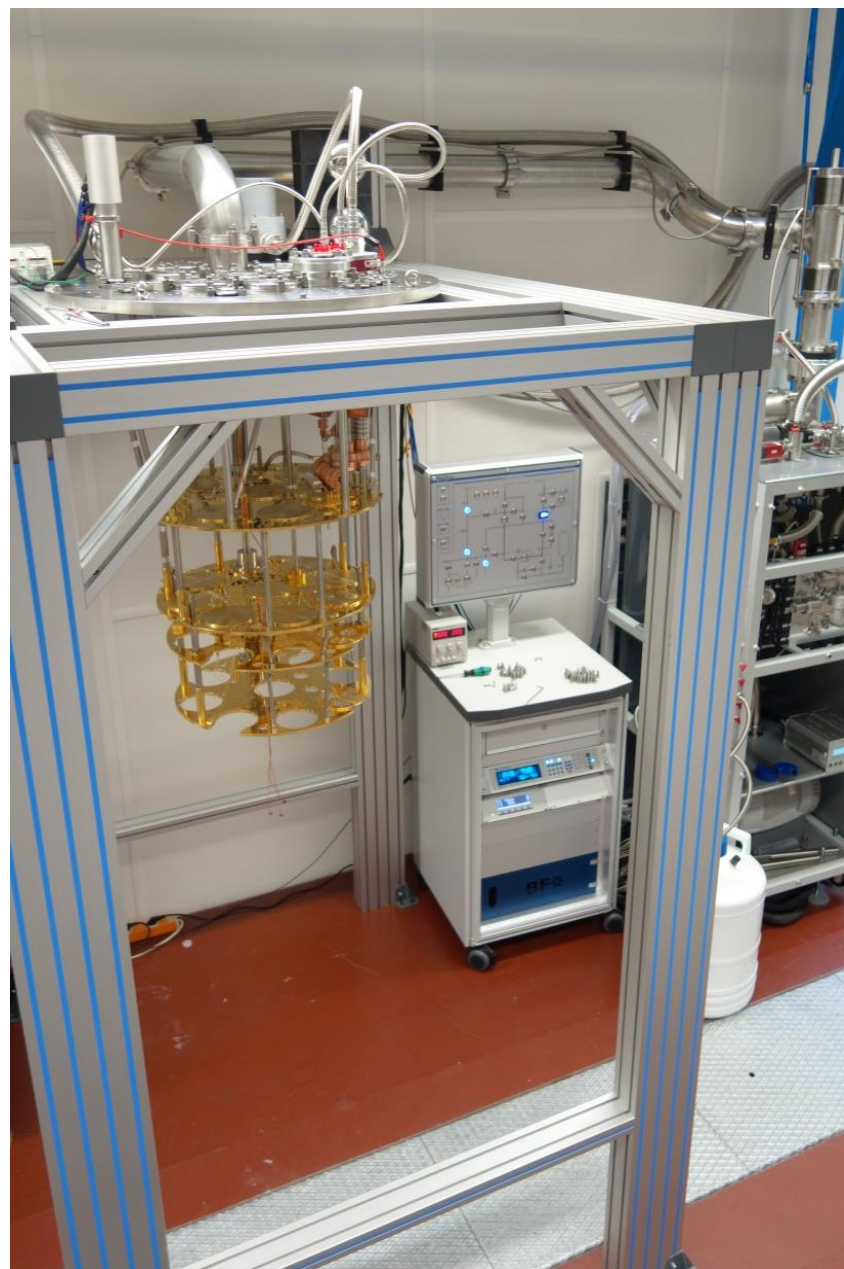

Performance

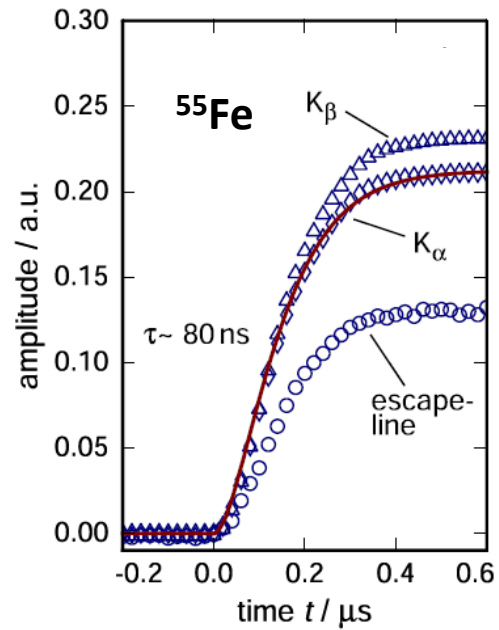

Fast risetime

→ Reduction

un-resolved pile-up

→ coincidence study

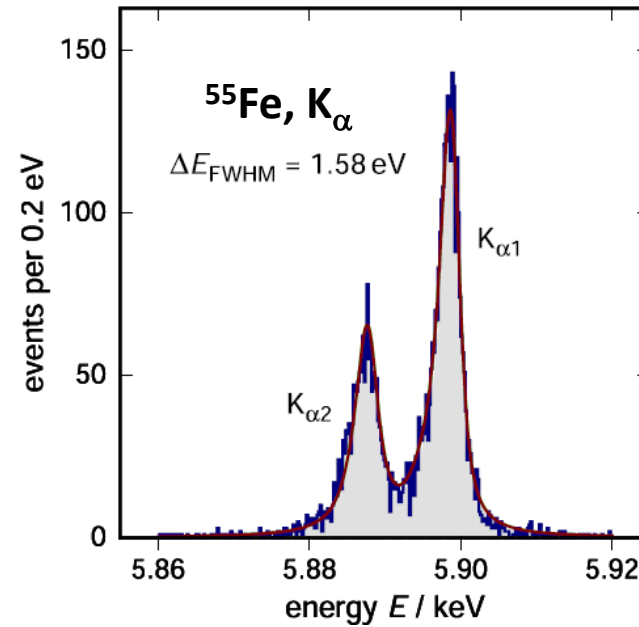

Extremely good energy resolution

→ identification of small structures

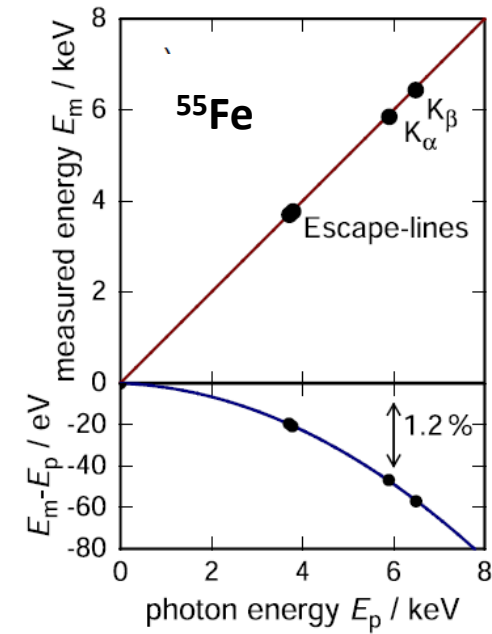

Excellent linearity

→ precise definition of the energy scale

Microcalorimeter arrays for X-rays spectroscopy - maXs

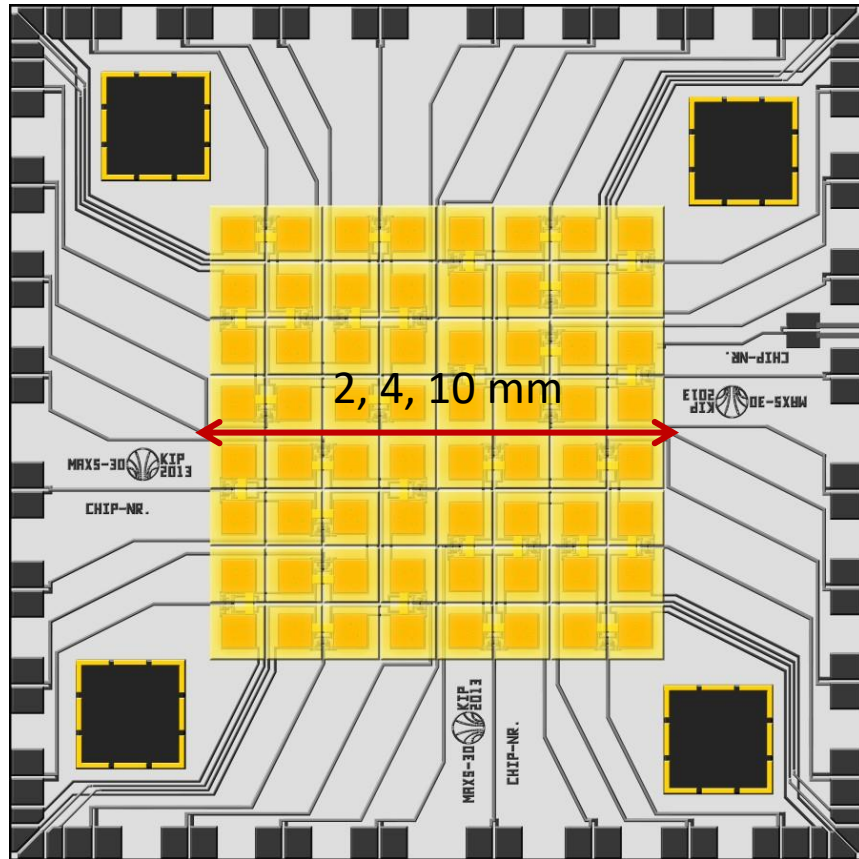

maXs-20/30/100:

- 8×8 pixels for photons up to 20/30/100 keV
- with $\Delta E_{\text{FWHM}} = 2/5/30$ eV
- 32 two-stage dc-SQUIDs

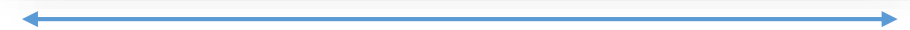
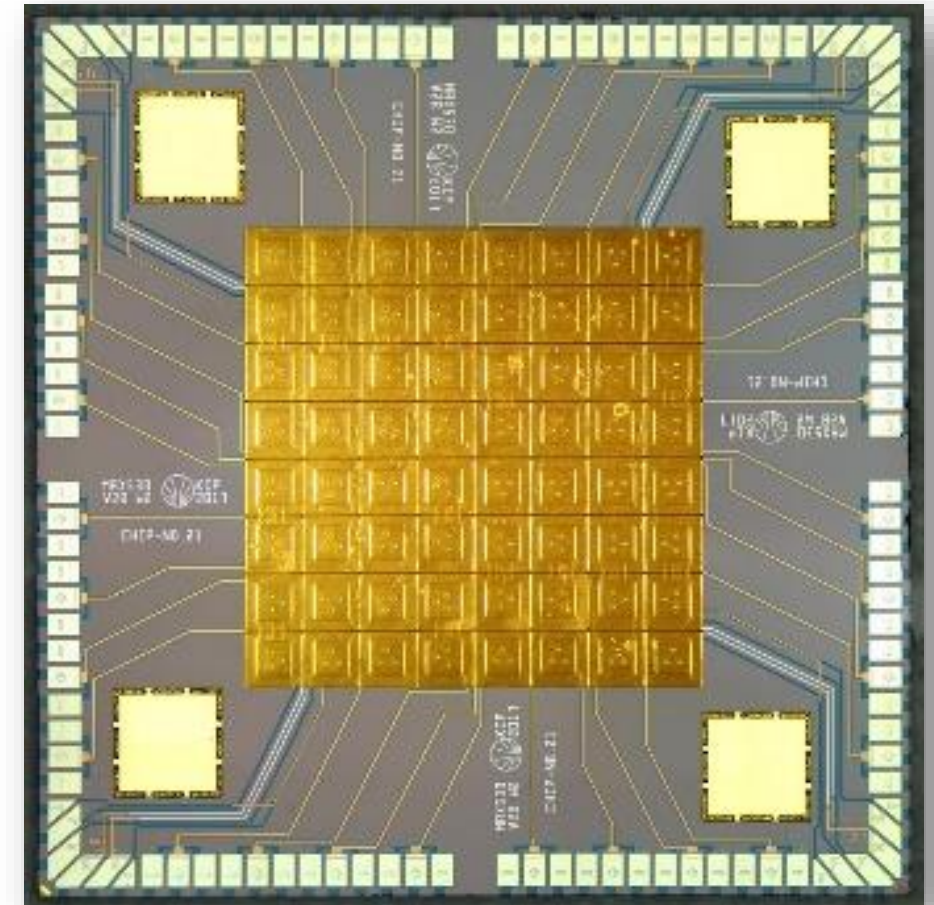

8 mm

maXs-30

Absorber size: $500 \times 500 \times 30 \mu\text{m}^3$

maXs-30 set-up for IAXO

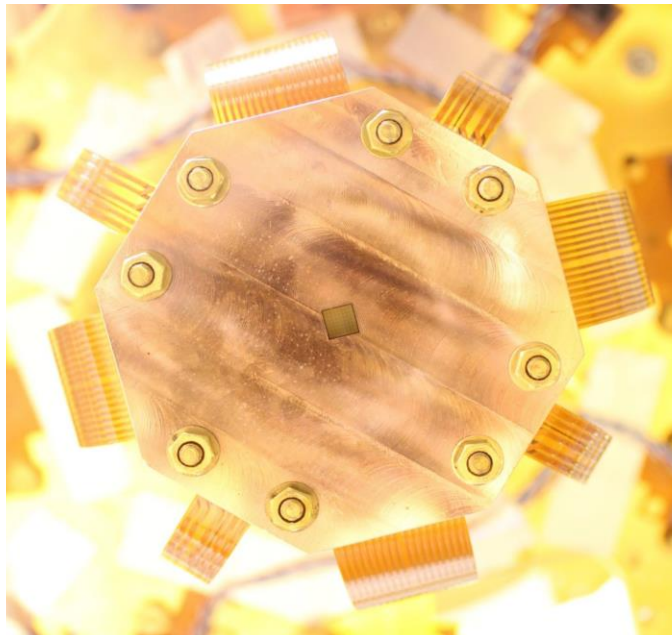
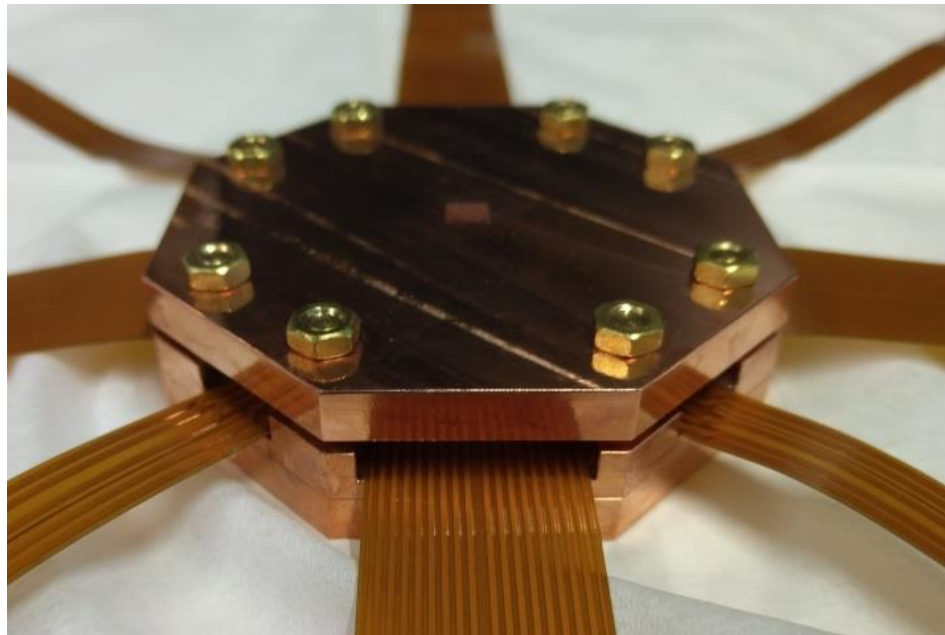
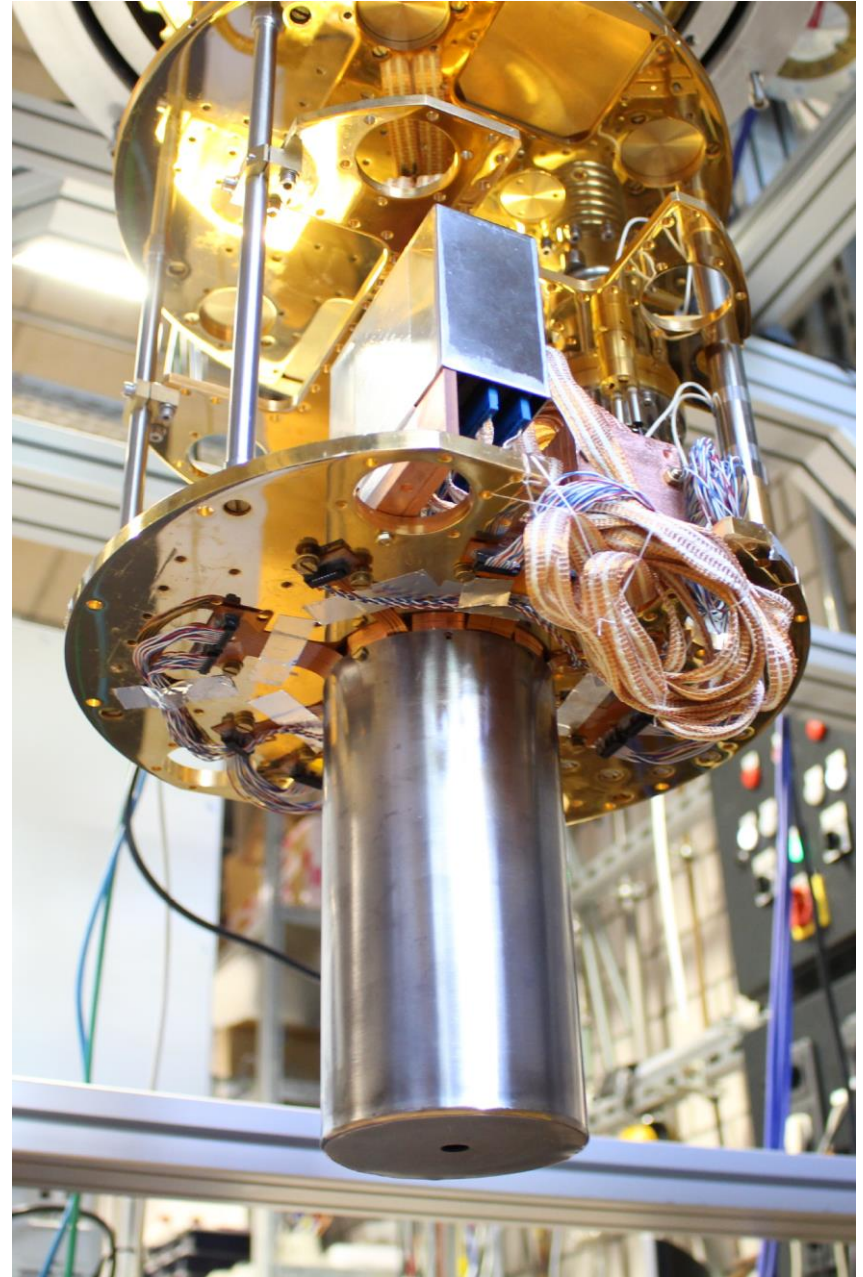
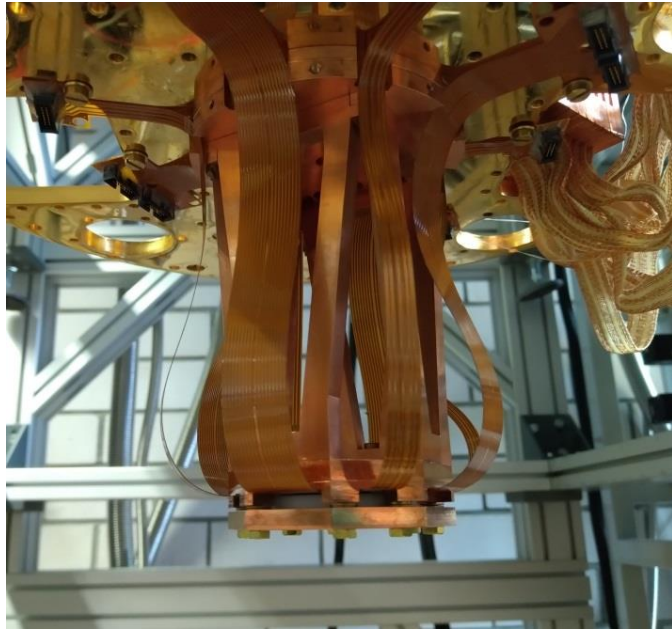
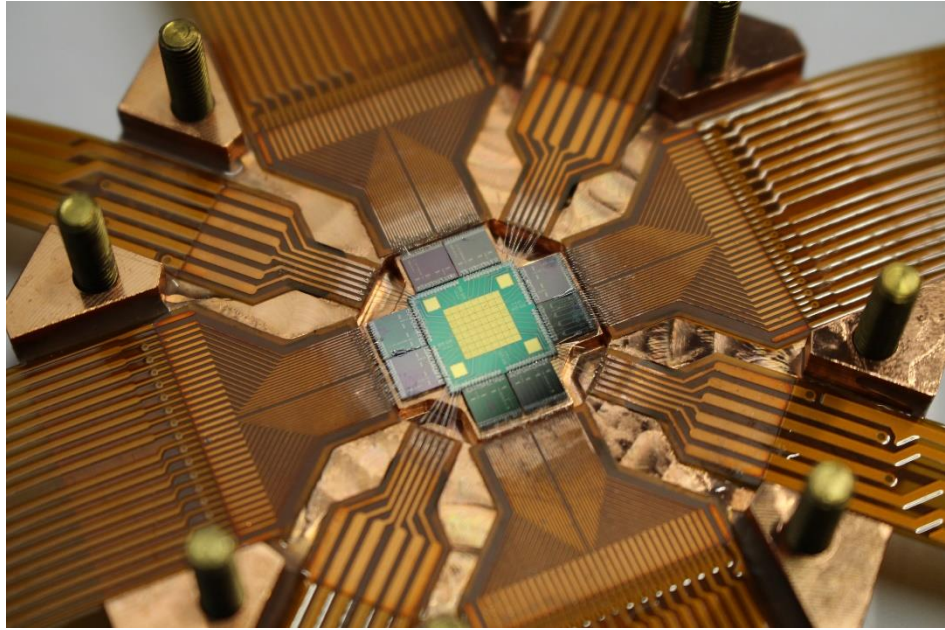

maXs-30 set-up for IAXO

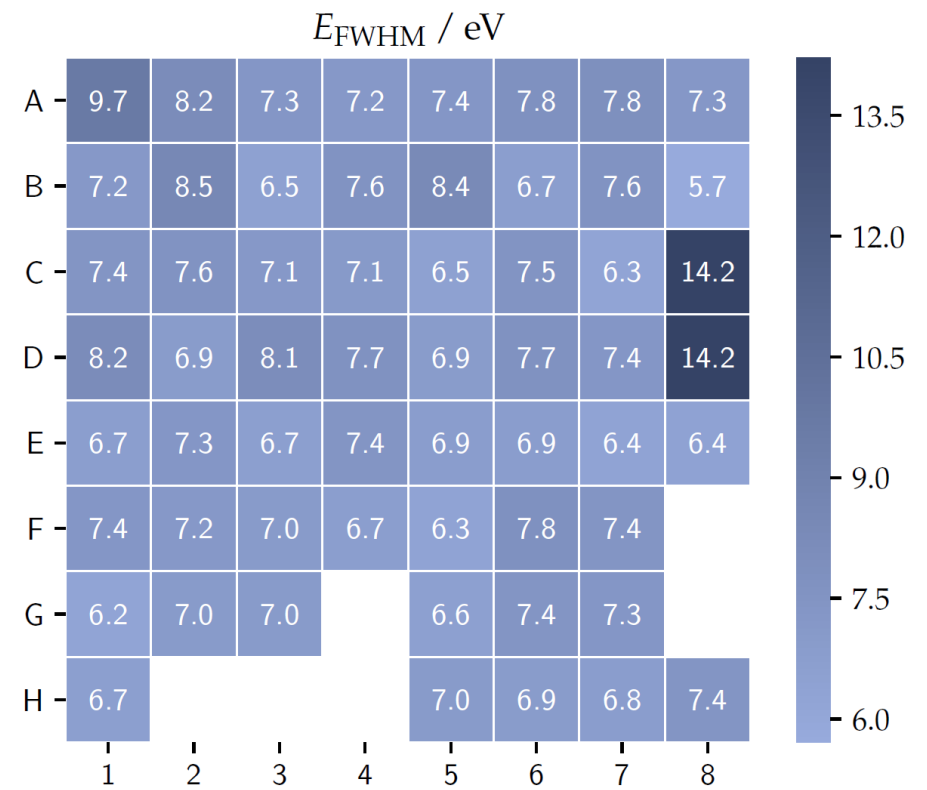
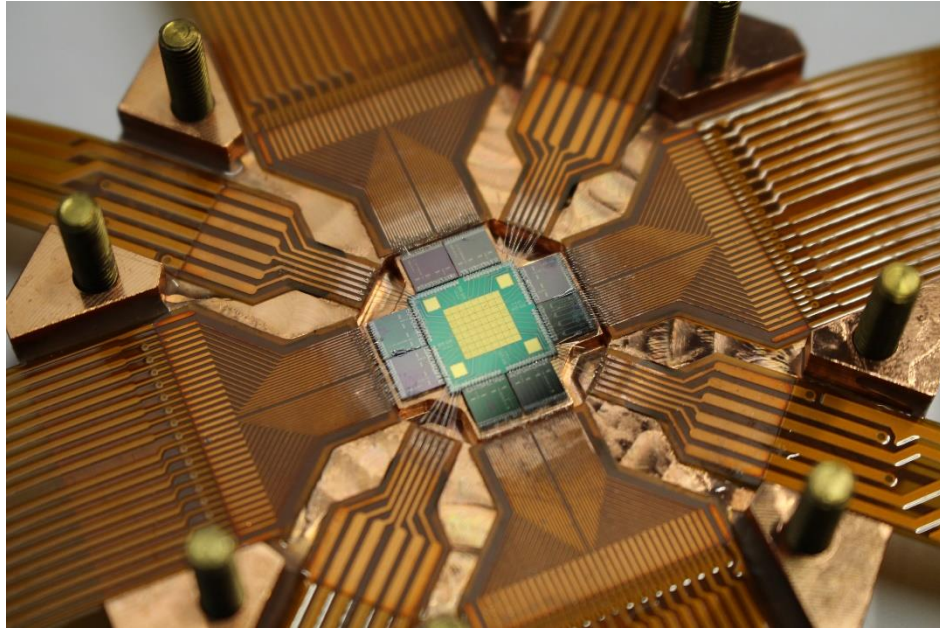

^{55}Fe calibration source

Stopping power @10 keV $\sim 100\%$

- Homogeneous performance over the array
- Stable operation over 1 month

D. Unger et al., *JINST* **16** (2021) P06006,
[arXiv:2010.15348](https://arxiv.org/abs/2010.15348) [physics.ins-det]

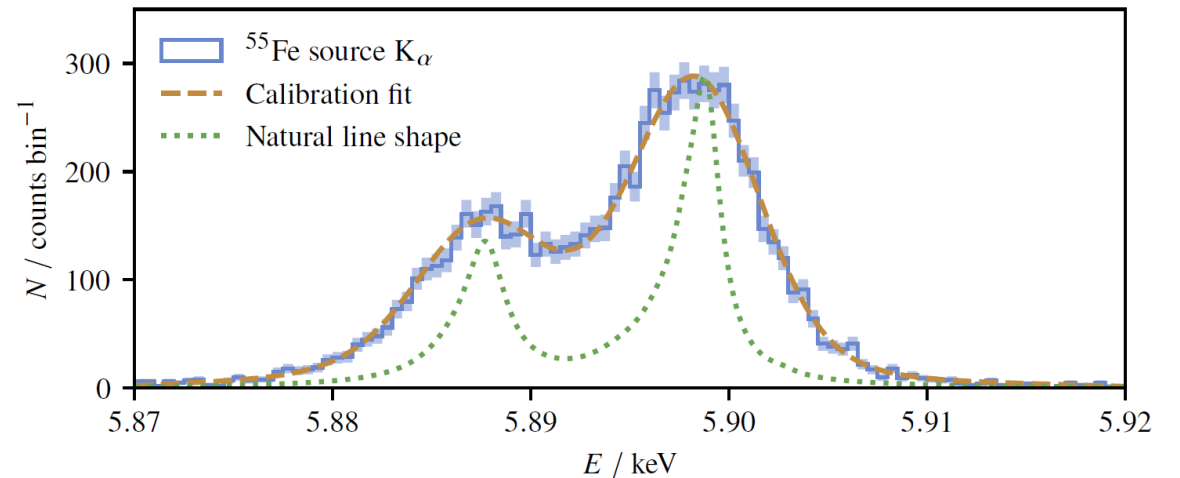

maXs-30 set-up for IAXO

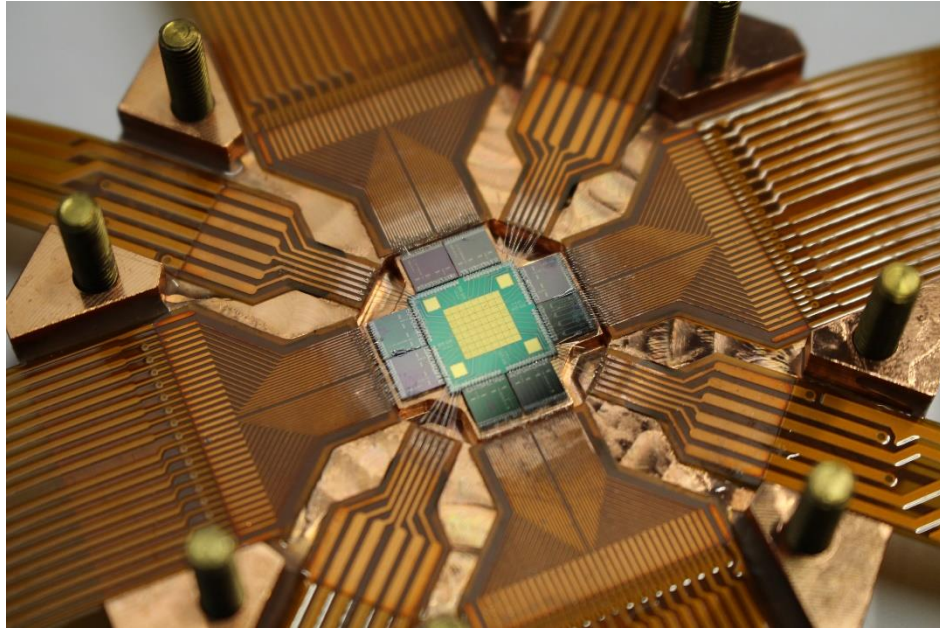

^{55}Fe calibration source

Stopping power @10 keV ~100%

- Homogeneous performance over the array
- Stable operation over 1 month

D. Unger et al., *JINST* **16** (2021) P06006,
[arXiv:2010.15348](https://arxiv.org/abs/2010.15348) [physics.ins-det]

Background spectrum (one month, no special shielding, no muon veto)

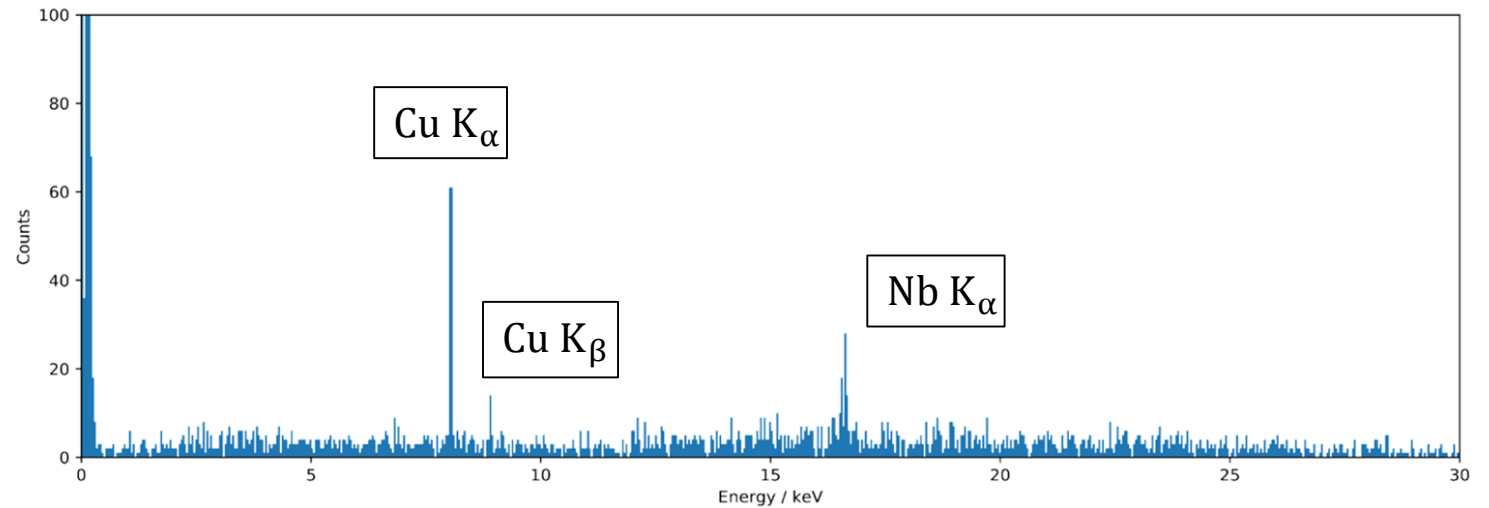

Cut efficiency > 90% (based on calibration lines)

Background estimation: $2 \cdot 10^{-4} \frac{\text{counts}}{\text{keV cm}^2 \text{ s}}$
(from 1 to 10 keV)

Still too high

→ development of a cryogenic veto

From maXs-30 to maXs-100

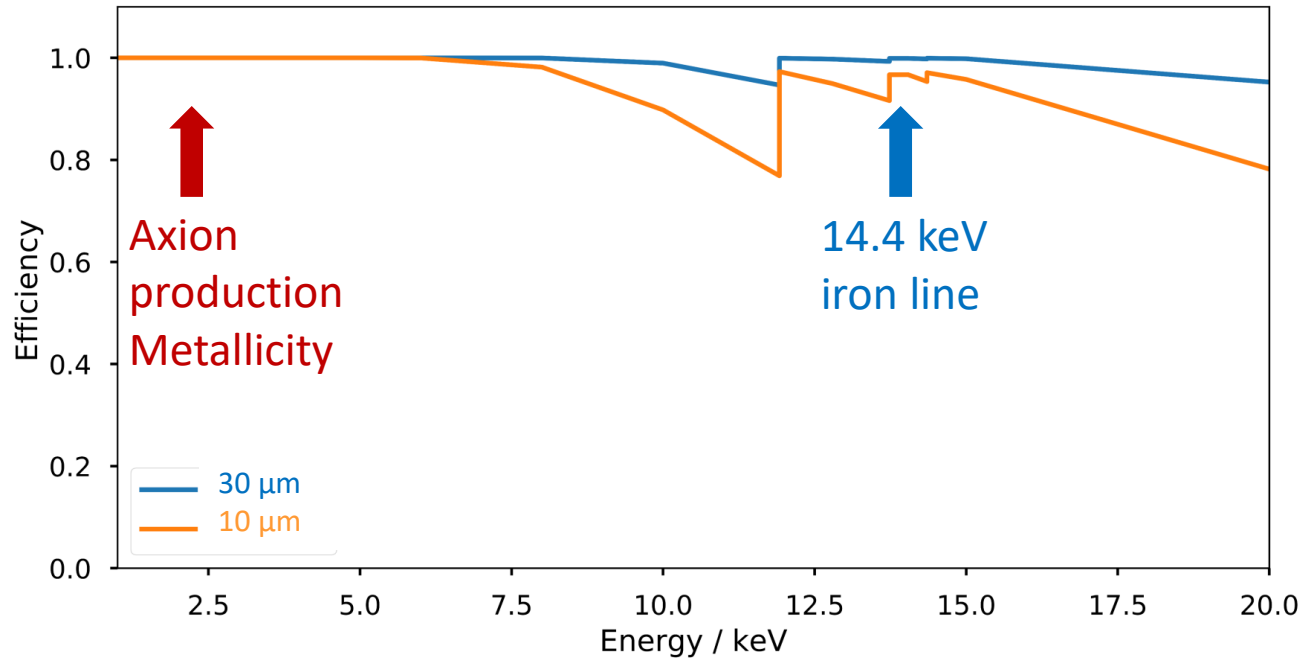

Au absorber volume can be adjusted for the particles to be detected

Sensor volume is optimized to match the heat capacity of the absorber at the working temperature

maXs-30

8 mm

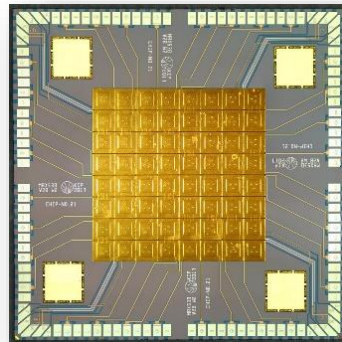

Same design, but scaled up!

maXs-100

15 mm

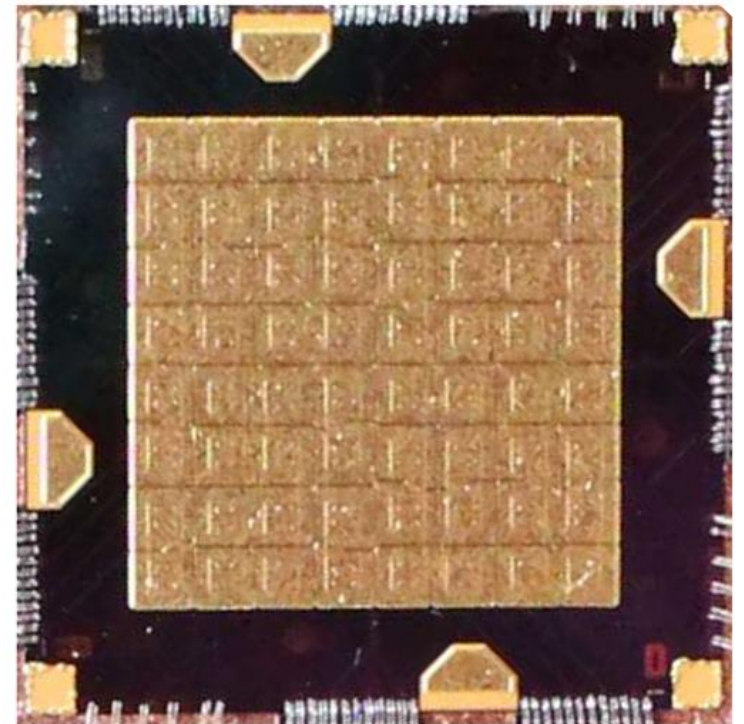

MMCs in IAXO: Challenges

Detector challenges:

- High efficiency in energy range 0 ... 10 keV
- High energy resolution
- Active area matching IAXO optics focal spot size

Setup challenges:

- Extremely low background of $10^{-8} \frac{\text{counts}}{\text{keV cm}^2 \text{ s}}$
- Good mechanical stability for operating while moving/vibrating
- Good magnetic shielding

Cryostat challenges:

- Reliable operation @ 20 mK
- Tiltable to 30°

} existing technology

Conclusions

Metallic magnetic calorimeters for IAXO

- high resolution
- wide range of energies
- impressive resolving power

To demonstrate:

- suitable background
- stable operation while tracking the Sun

Achieved MMC performance motivates the efforts !

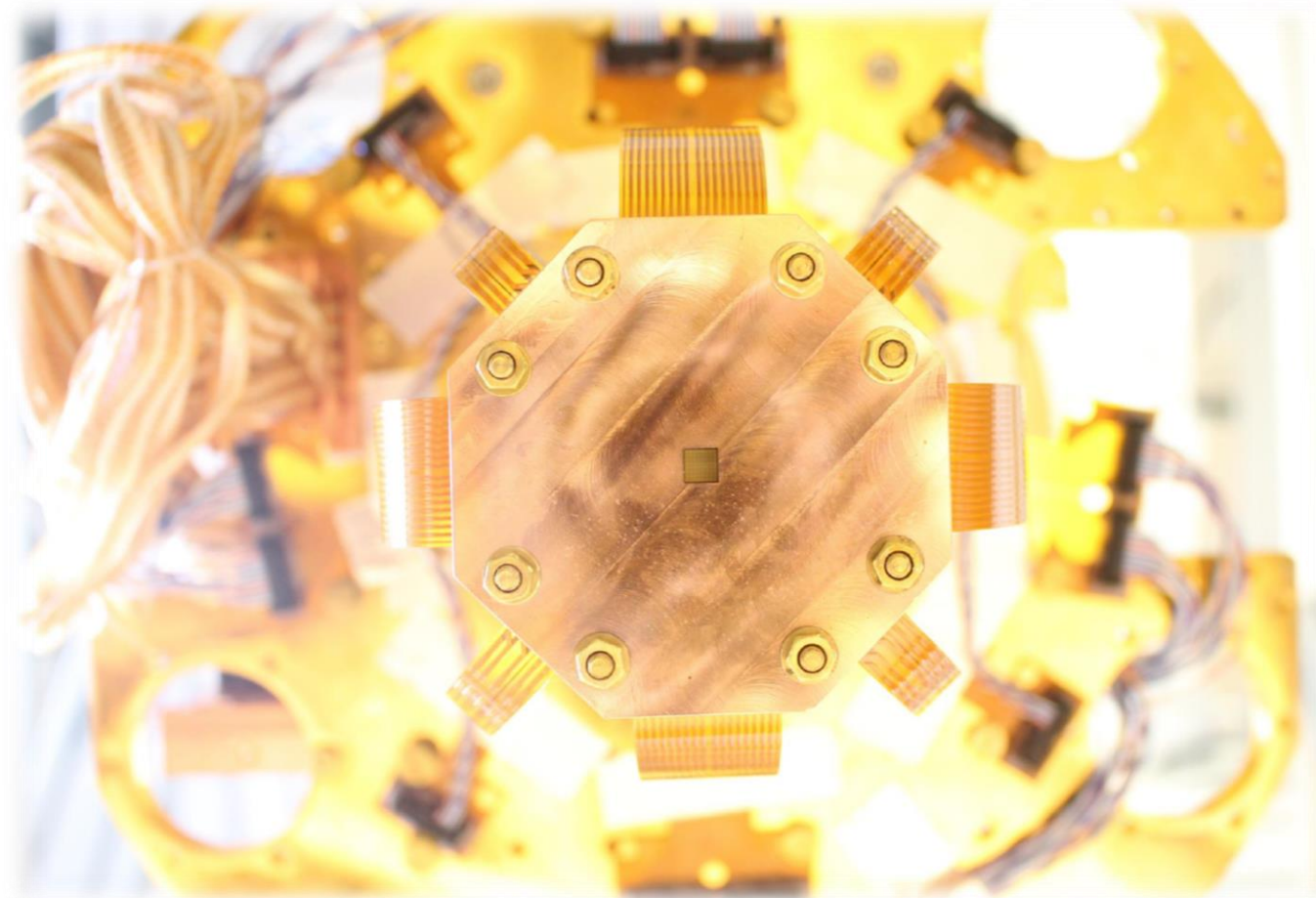

Conclusions

Metallic magnetic calorimeters for IAXO

- high resolution
- wide range of energies
- impressive resolving power

To demonstrate:

- suitable background
- stable operation while tracking the Sun

Achieved MMC performance motivates the efforts !

Thank you for the attention!

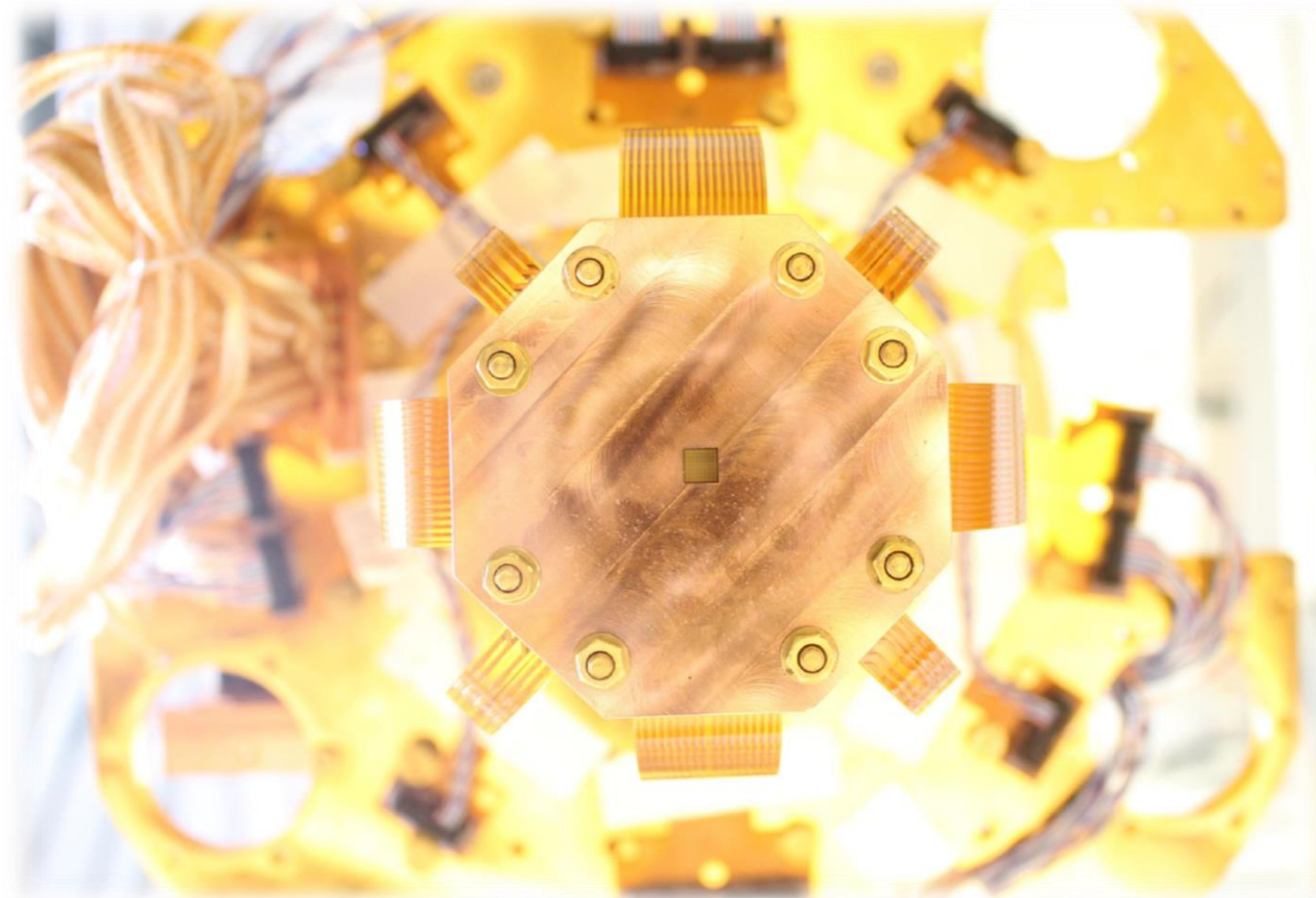

MMC fabrication

40 m² Cleanroom class 100
at Kirchhoff Institute for Physics

Wet bench

Chemistry bench

Maskless aligner

UHV sputtering system

Dry etching system

- Flexibility in design and fabrication
- Reliable processes for thin films
- Production of MMC array and superconducting electronics



Detector setup V1



- First IAXO detector setup
- Designed for and equipped with *maXs30* detector
- Only used radiopure materials (copper and Kapton)
- Magnetic shielding (Nb shield)
- Measured and characterized within last half year

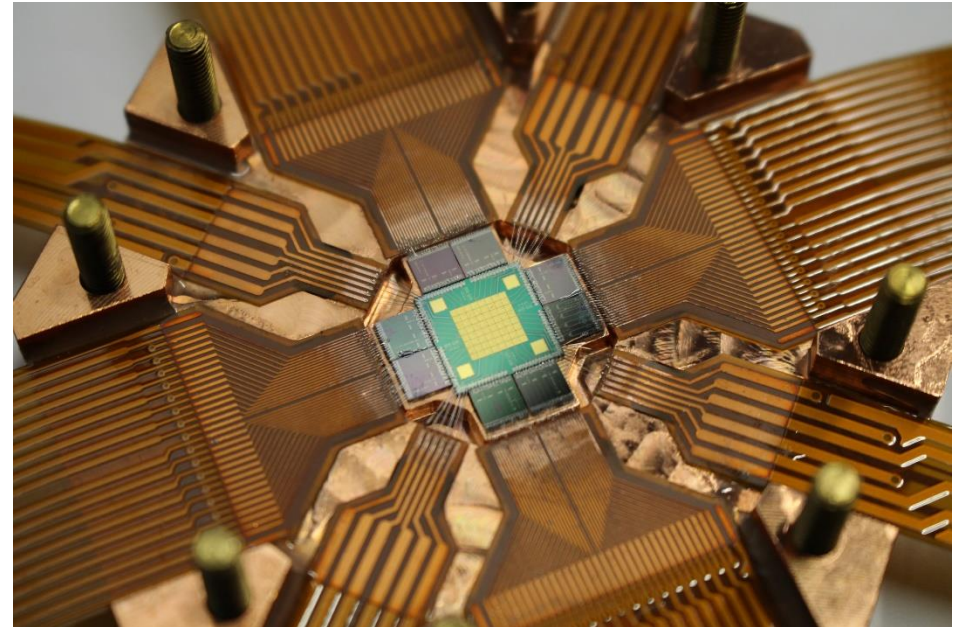

Detector setup V2

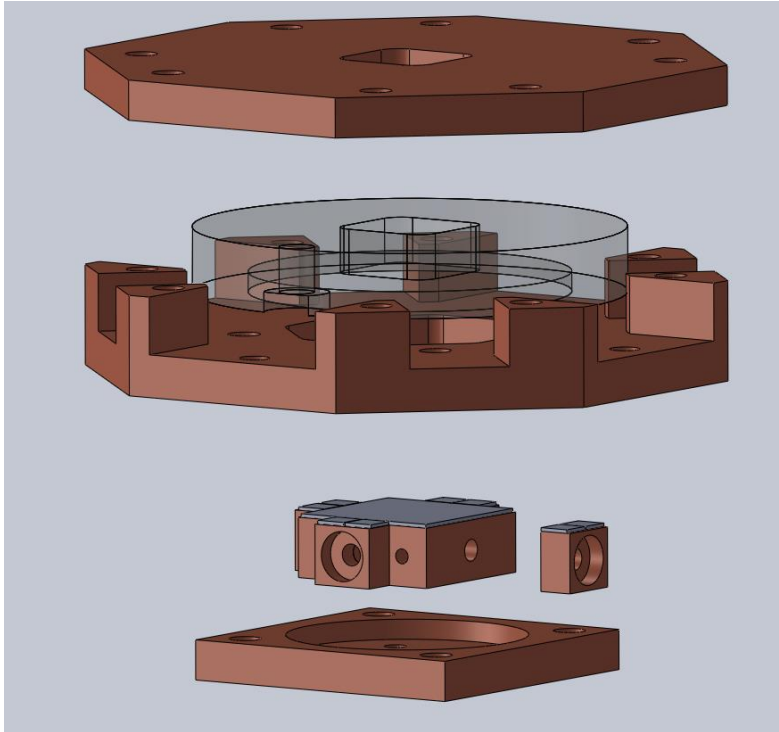

New features:

- Modularized detector and SQUID holder
→ easy repair
- Optimized for new detector
maXslAXO
- Additional inner teflon shield to
reduce background

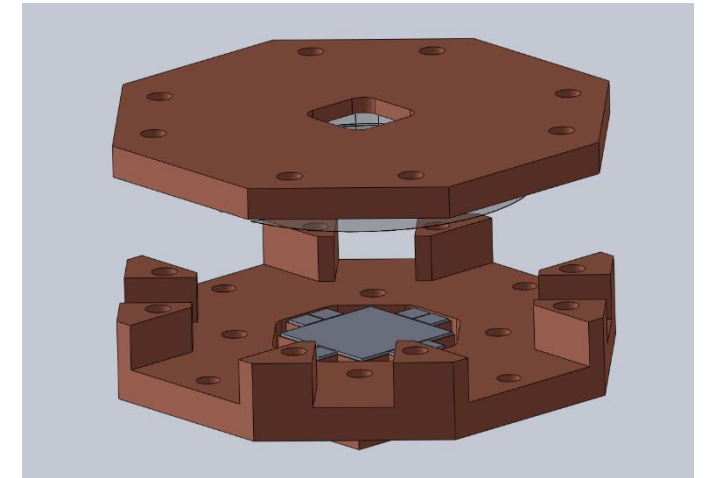

Detector setup V2

Current state:

- Copper parts are produced, ready to be assembled
- *maXslAXO* is prepared to be produced in cleanroom

Next steps:

- *maXslAXO* wafer production in cleanroom
- Assembling and characterization of *maXslAXO* V2 setup
- Background measurements

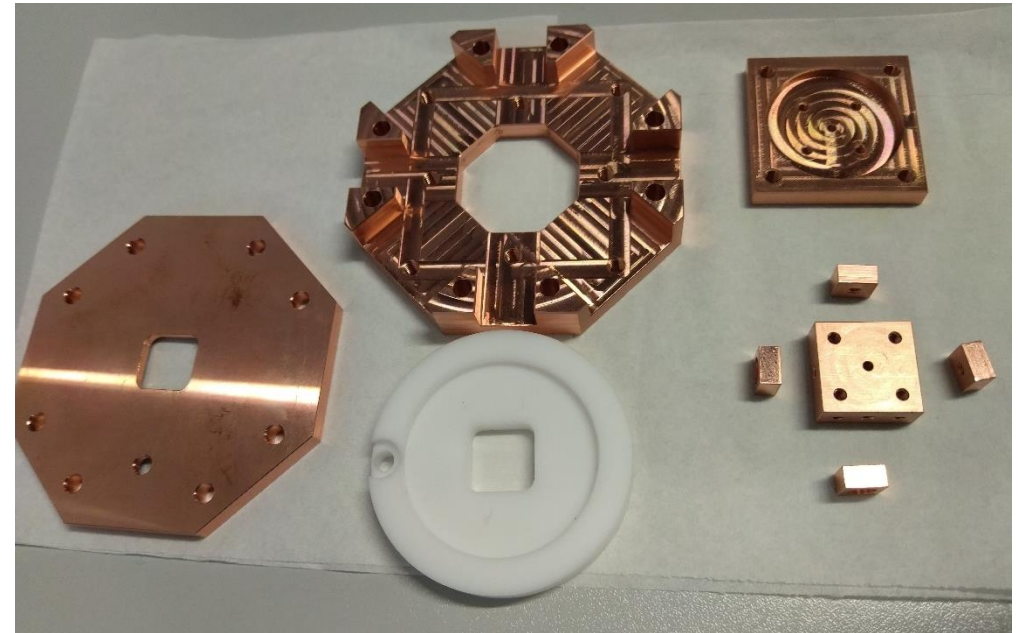

maXs-30 set-up for IAXO

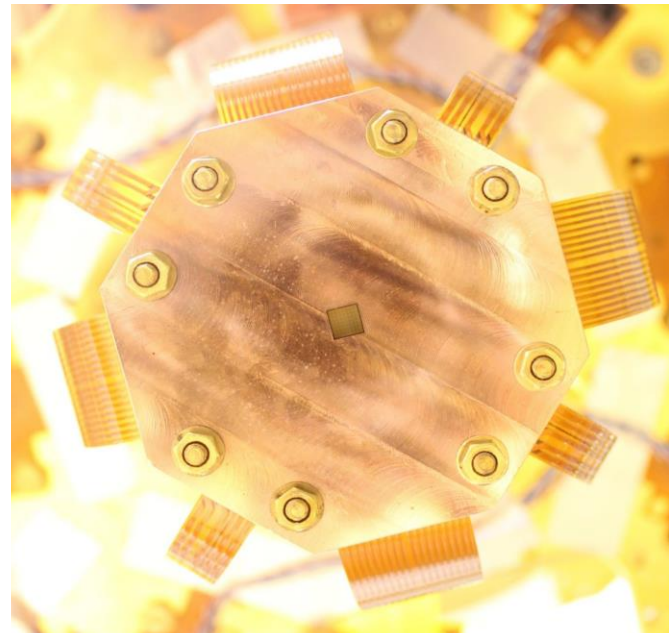
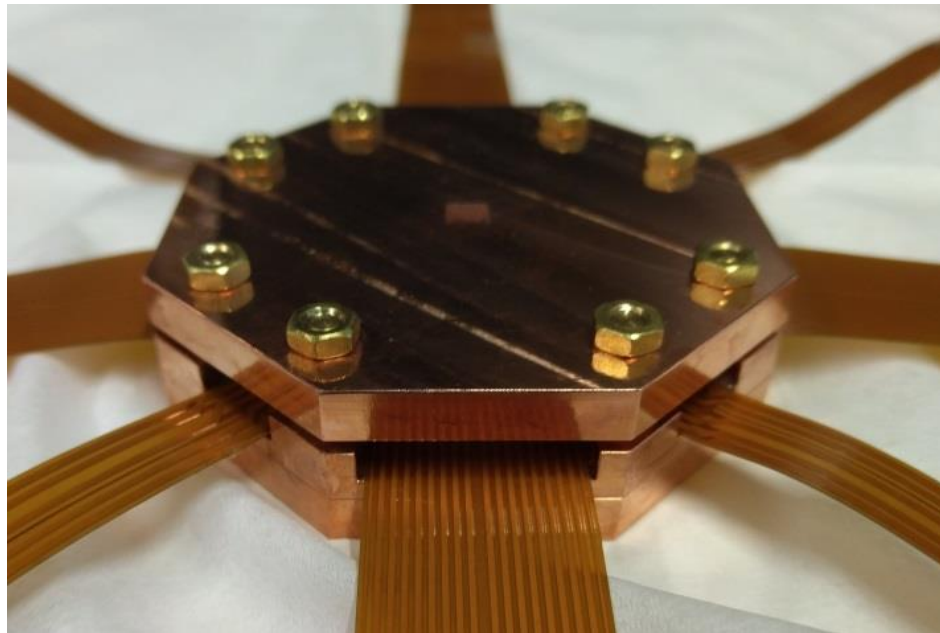
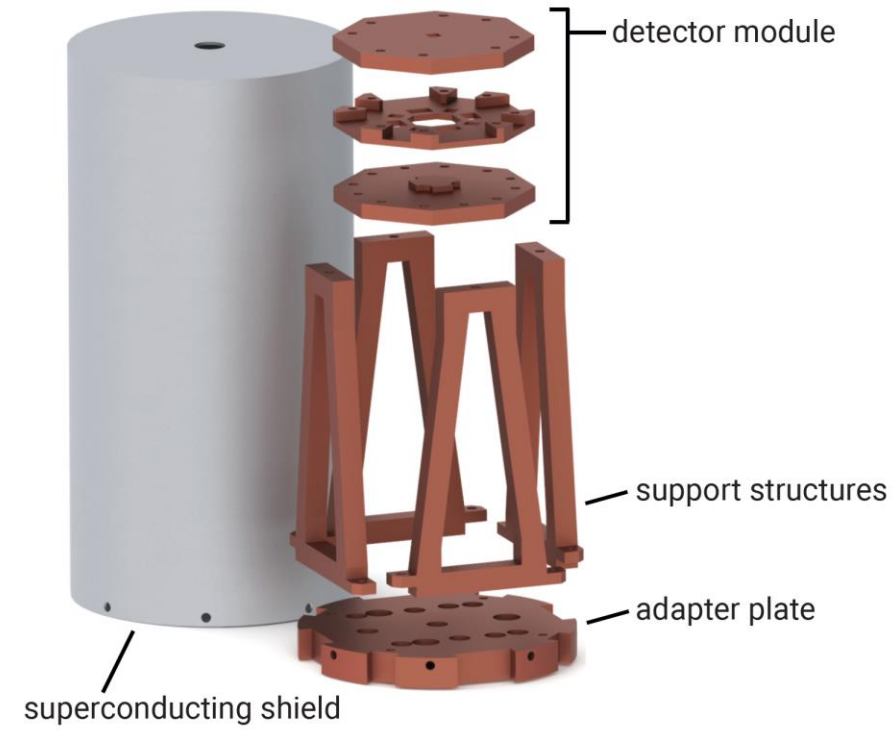
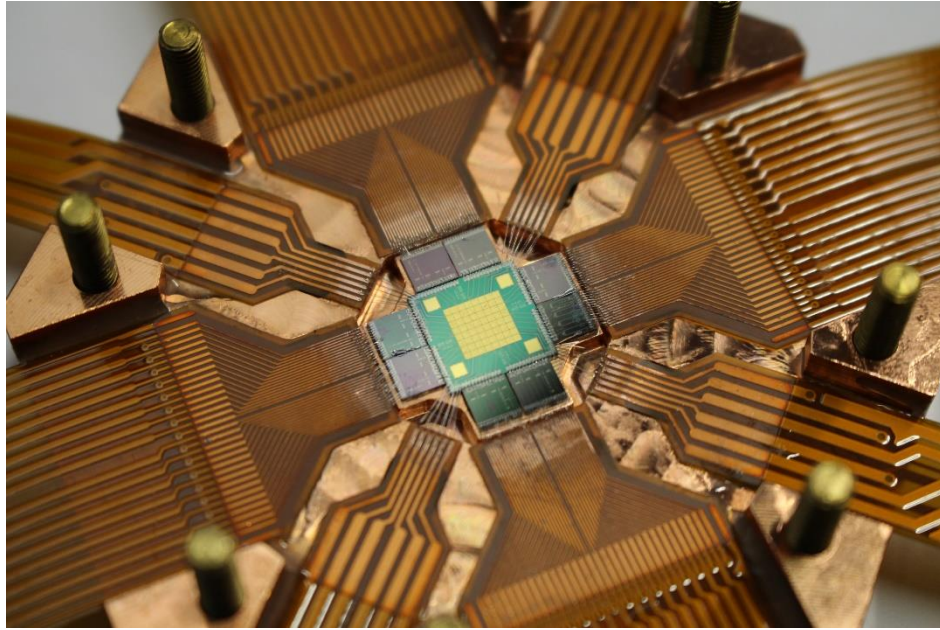

Design suitable for IAXO telescope

High purity materials for background reduction

D. Unger et al., *JINST* **16** (2021) P06006,
[arXiv:2010.15348](https://arxiv.org/abs/2010.15348) [physics.ins-det]

Tiltable cryostat: BlueFors ASM-LH250

