



UNIVERSITÀ DEGLI STUDI DI MILANO  
DIPARTIMENTO DI FISICA

# Atomi per la salute



Simone Manenti  
[simone.manenti@unimi.it](mailto:simone.manenti@unimi.it)

# 1986 - Chernobyl (2011 - Fukushima)

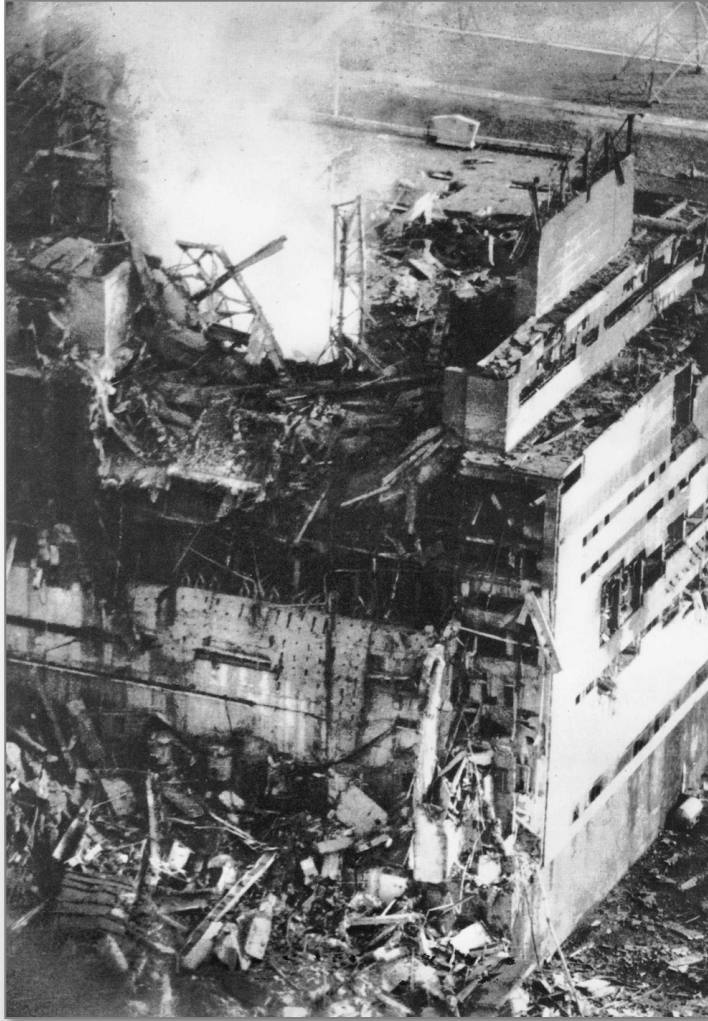

# 1945: Hiroshima and Nagasaki

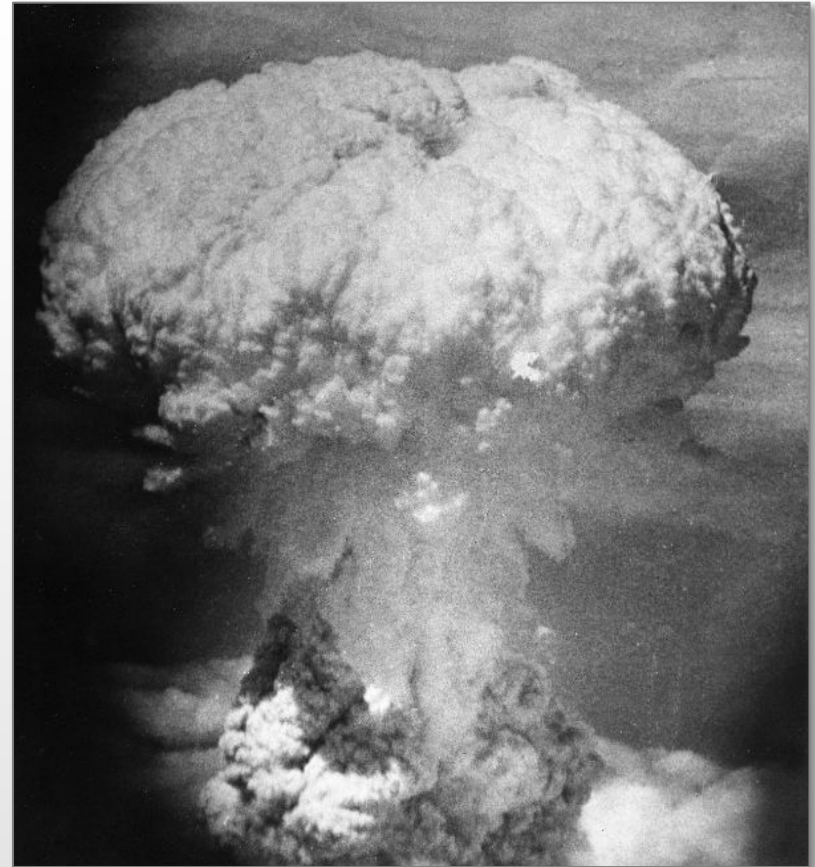

# Physics and Medicine

1895

Wilhelm Conrad Röntgen  
“X-ray discovery”

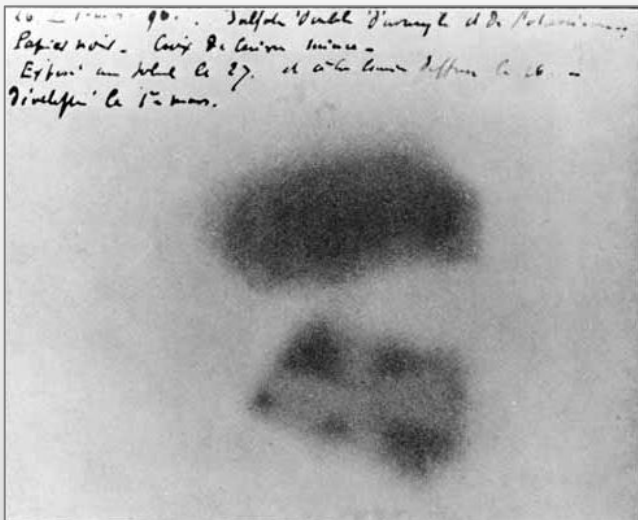
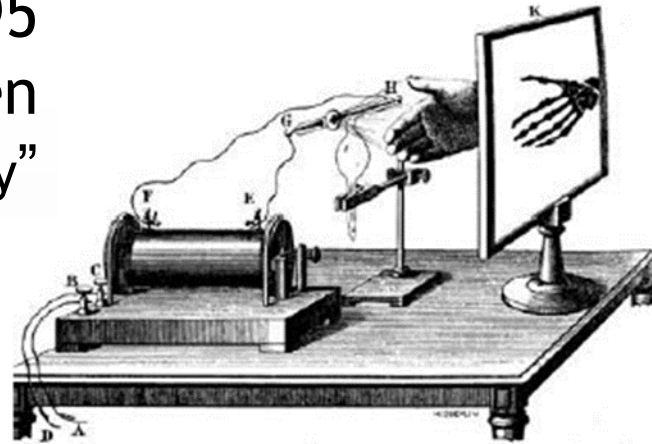

1896

Antoine Henri Becquerel

“...rays, whose effects have a great similarity to the effects produced by the rays studied by M. Lenard and M. Röntgen.”

# Physics and Medicine

1898

Maria Salomea Skłodowska  
and Pierre Curie

“discovery of spontaneous radioactivity”

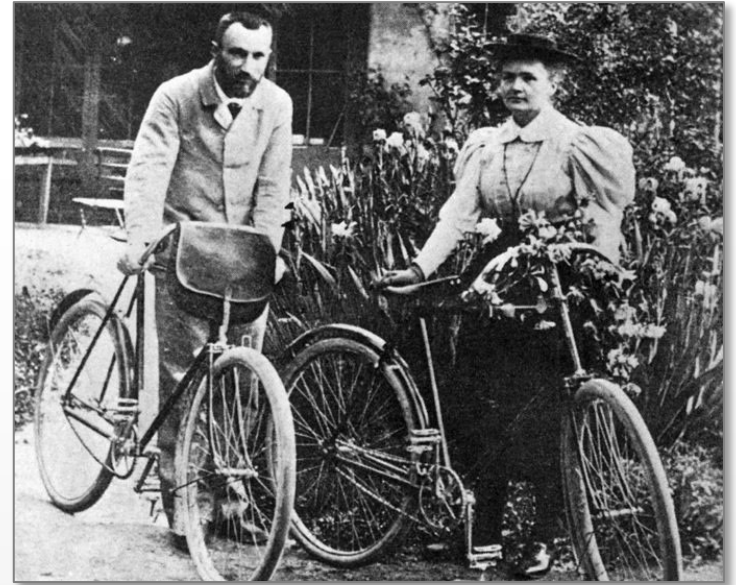

PHYSIOLOGIE. — *Action physiologique des rayons du radium.*  
Note de MM. **HENRI BECQUEREL** et **P. CURIE.**

1901



Pierre Curie  
1859-1906

Brûlure du bras de Pierre Curie

# Physics and Medicine

1898

Maria Salomea Skłodowska  
and Pierre Curie

“discovery of spontaneous radioactivity”

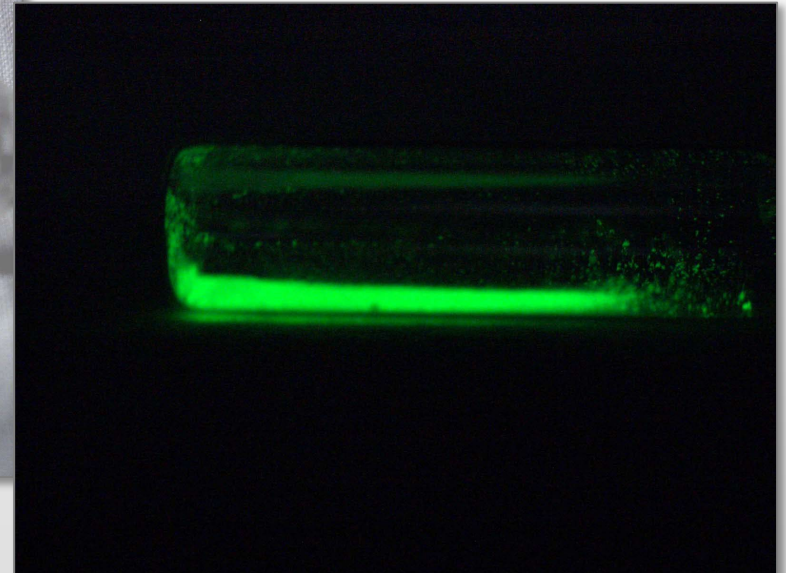
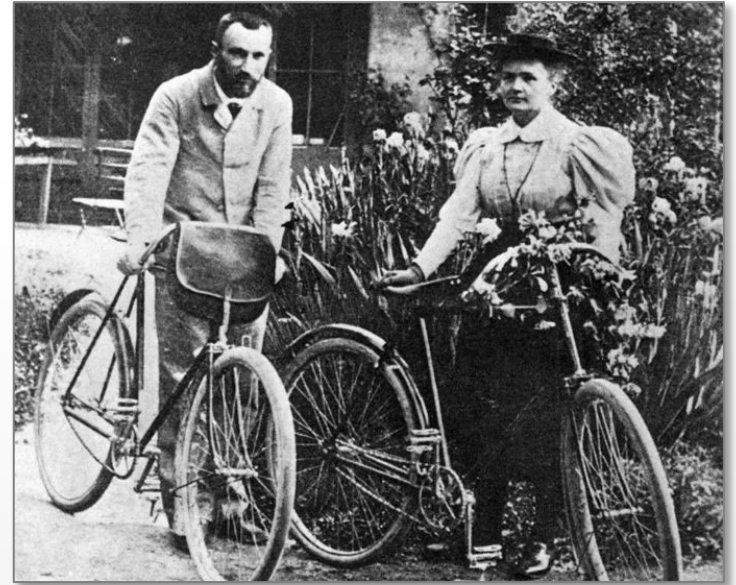

# 1914, Röntgenotherapy and “petites Curie”

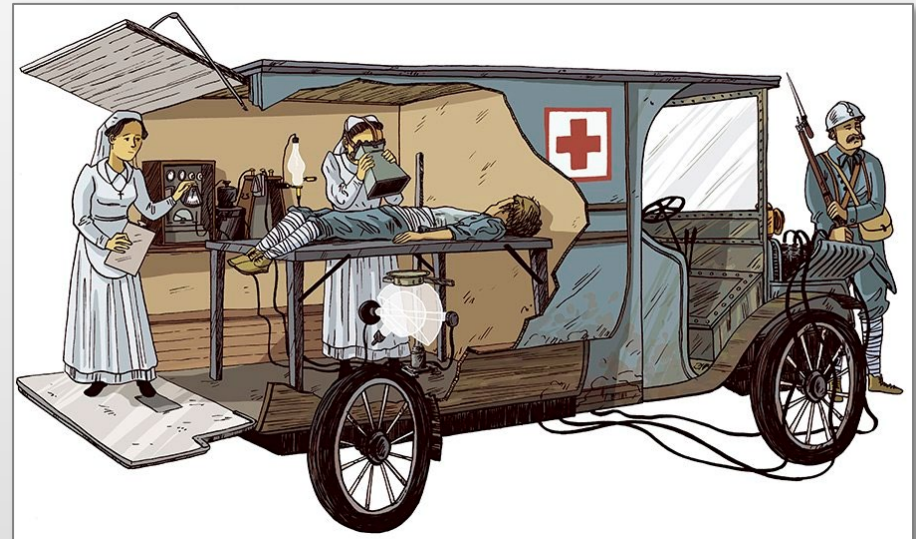
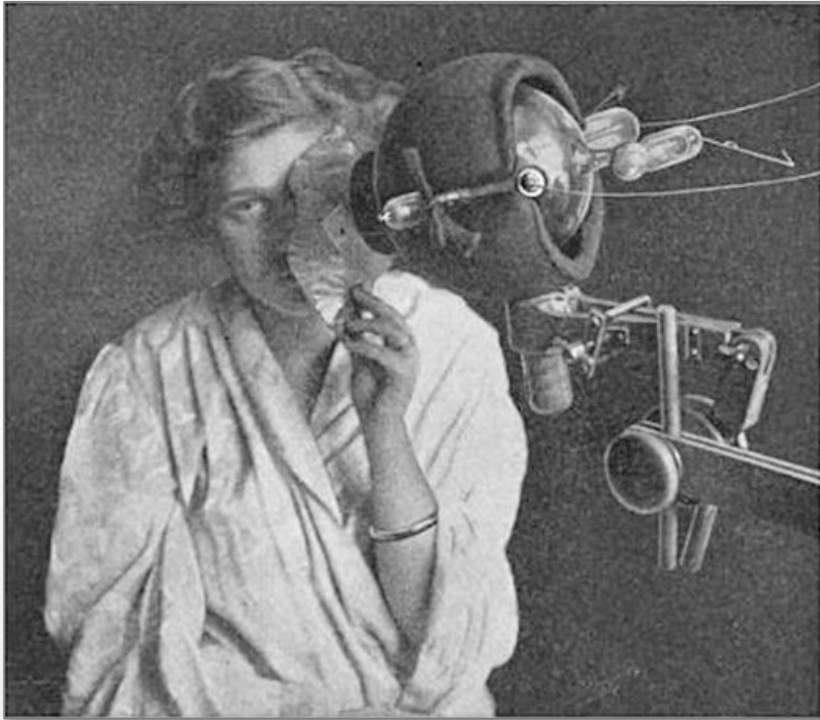

# Curietherapy (brachytherapy)

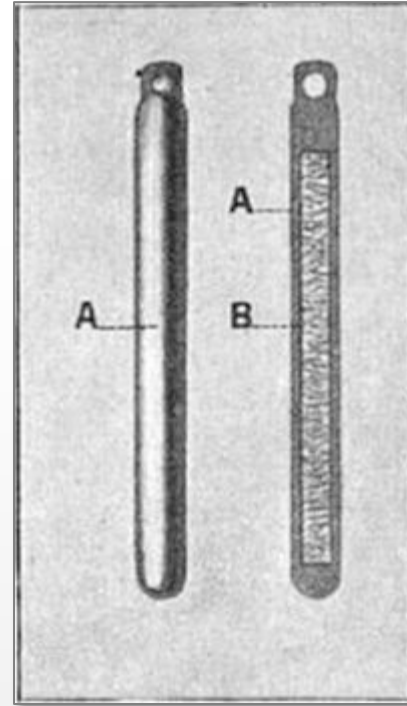

the use of radium salts

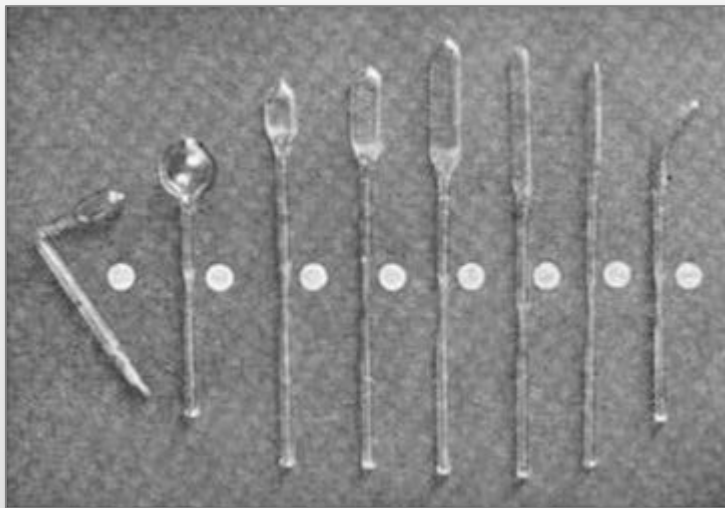

the use of radium emanation, niton (now referred to as radon)



# Physics and Medicine

1898

Maria Salomea Skłodowska  
and Pierre Curie

“discovery of spontaneous radioactivity”

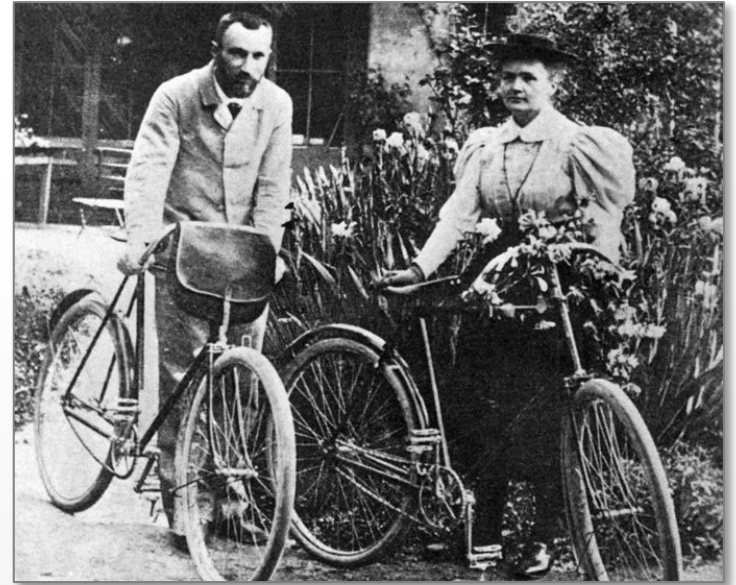

PHYSIOLOGIE. — *Action physiologique des rayons du radium.*  
Note de MM. **HENRI BECQUEREL** et **P. CURIE.**

1901

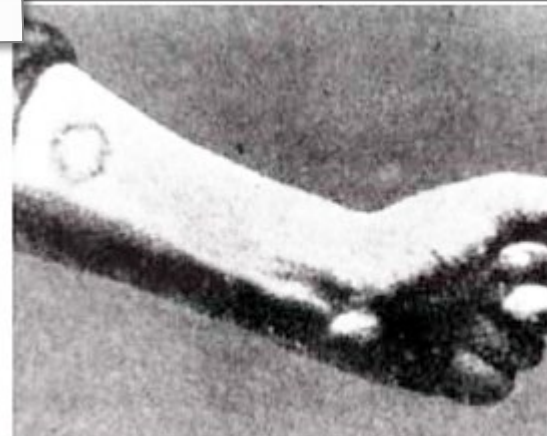

Pierre Curie  
1859-1906

Brûlure du bras de Pierre Curie

# Medical to non-medical application of radium



### LE RADIUM ET LES RIDES

☛☛☛

*Extrait de la Presse scientifique:*

... Il est aujourd'hui démontré que les grands cosmétologistes contiennent du radium, possèdent, contre les rides, contre la peau lasquée, un puissant régénérateur incomparable et sans danger. On sait que le radium est le meilleur régénérateur des tissus fatigués et qu'il leur restitue une vitalité nouvelle. On a donc imaginé d'incorporer dans une crème de beauté, dans un savon, dans un lait, des sels de radium, de manière à utiliser ce produit à une fin constante contre les lézards du visage et surtout contre ce terrible ennemi des cellules de la vie, cause primordiale des rides, l'est le, il faut le reconnaître, un moyen ingénieux d'employer, à peu de frais, les précieuses émanations de ce produit coûteux; et c'est, sans inconvénient, le meilleur moyen de combattre les rides, bien supérieur à tout ce qu'on a trouvé jusqu'ici. Fichons donc les Laboratoires Ramey d'arrêter ou d'éviter les rides d'acquiescer eux-mêmes les sels de radium dans leurs produits, vendus sous le nom de *Produits radiacés Ramey* (crème, savon, lait, shampooing), et de nous donner aujourd'hui cette merveilleuse Crème Ramey, qui veloute et parfume le visage, efface vraiment les rides, les fêlures, le rouge du nez, les taches de rousseur, les points noirs, l'acné.

Docteur PHILIPPON.

## LE RADIUM RÉGÈNÈRE L'ÉPIDERME

PLUS DE  
RIDES



TEINT  
VELOUTÉ

# LA CRÈME RAMEY

## RADIACÉE CONTIENT DU RADIUM

**CRÈME radiacée RAMEY**  
*Le Pot, grand modèle* 0 fr. 40  
*Le Pot, moyen modèle* 5 fr. 50  
*Le Tube* 2 fr. 50

**LAIT radiacé RAMEY**  
*Le Flacon* 11 fr. 75

**SAVONS radiacés RAMEY**  
*Savonnette enveloppée* 2 fr. 95  
*La Boîte riche* 8 fr. 50  
*Bath Sapsolo D'opéra* 2 fr. 95

**SHAMPOOING radiacé RAMEY**  
*(avec et sans Quinquina)*  
*Le Sachet pour 1 lit. d'eau* 0 fr. 45  
*Les 12 sachets* 5 fr.

**POUDRE RAMEY (6 teintes)**  
*Bianche - Naturelle*  
*Ocre Africain*  
*Rachel - Rose - Ocre*  
*La boîte, grand modèle* 5 fr. 50  
*Le petit modèle* 3 fr.  
*Le petit modèle* 0 fr. 95

**EN VENTE :**  
chez Coiffeurs-Parfumeurs,  
et Grands Magasins,  
et aux Laboratoires des  
**Produits radiacés**  
**RAMEY**  
5 bis, rue Jean-Jacques  
PUTEAUX (Seine)  
qui enverront franco recommandé  
contre timbre ou mandat  
**GRATIS Notice détaillée**  
et attestations sur  
demande directe aux  
Laboratoires.



# Non-medical application of X-ray

**Hair Removed Permanently**



Patient receiving treatment on the back. No pain or sensation of any kind. The **INFALLIBLE** method successfully used for 16 years by Dr. Albert C. Geyser, late Professor of Electrical Therapeutics at Cornell University and endorsed by many leading physicians.  
*No Needle, No Wax, No Chemical*  
*Painless and Harmless—Guaranteed to be Permanent*

**Tricho System**

Central 5013 1010 State-Lake Bldg. 190 N. State St. Free needles

*An Innovation!*

## X-Ray Shoe Fitting With the Foot-O-Scope

HERE'S news that will be hailed with joy by thousands of Scrantonians who have long wished to KNOW EXACTLY how their shoes fit.

In keeping with our policy of "service first" we have just installed a FOOT-O-SCOPE—a wonderful X-Ray machine that enables you to ACTUALLY SEE the bones of your feet within the shoes. Think what an advantage that is—TO PLAINLY SEE YOUR FEET INSIDE YOUR SHOES!



**This Is the  
X-Ray Machine**

\* It is one of the wonders of science and by far the greatest help to proper shoe fitting any store ever had.

It shows conditions as they are beneath the surface. The three persons in the above illustration are actually seeing the young lady's feet in her shoes—the alignment of the bones and whether or not the shoes are a correct fit in length, breadth and shape.

What you see when you look in the Foot-O-Scope



This shows the foot of a 14-year-old girl. The shoe is too narrow and too short. The last (shape) is wrong and has forced the bones out of alignment and serious sprains are quite sure to follow.

What you see when you look in the Foot-O-Scope



This shows a correctly sized shoe. Note that the bones are straight and that they have room to spread lengthwise and sideways. This is the way ALL shoes should fit if comfort is a consideration.

## It's For Everybody!

By all means do not get the impression that this service is exclusively for patrons of the "Always Busy" store. THIS SERVICE IS FOR EVERYBODY, whether patrons of this store or not. We wouldn't be selfish enough to restrict the use of a machine that means so much to humanity—and we want you to feel perfectly free to come in at any time and SEE THE BONES OF YOUR FEET as they really are, without being obligated to us in the least.

So, just bear in mind, please, that this service is for EVERYBODY!

**"Always Busy"**  
(Trade-Mark)

# Lewis & Reilly

114-116 Wyoming Avenue



# Non-medical application of X-ray



**X-RAY  
SPECS**  
ONLY \$1<sup>00</sup>  
A Hilarious  
Optical Illusion

Scientific optical principle really works. Imagine - you put on the "X-Ray" Specs and hold your hand in front of you. You seem to be able to look right through the flesh and see the bones underneath. Look at your friend. Is that really his body you "see" under his clothes? Loads of laughs and fun at parties. Send only \$1 plus 25c shipping charges. Money back guarantee!

HONOR HOUSE PRODUCTS CORP., Lynbrook, N.Y. Dept. 97XR02



"I CAN SEE  
HIS TRUE  
INTENTIONS!"

**X-RAY  
FOR  
GIRLS**

FUTURE OF  
TORMENT  
AND  
PAIN

ONLY  
\$1<sup>00</sup>

**PREVENT  
A LIFE OF  
MISERY**

# Medical to non-medical application of radium



### LE RADIUM ET LES RIDES

☛☛☛

*Extrait de la Presse scientifique:*

... Il est aujourd'hui démontré que les grands cosmétologistes contiennent du radium, possèdent, contre les rides, contre la peau lasquée, un puissant régénérateur incomparable et sans danger. On sait que le radium est le meilleur régénérateur des tissus fatigués et qu'il leur restitue une vitalité nouvelle. On a donc imaginé d'incorporer dans une crème de beauté, dans un savon, dans un lait, des sels de radium, de manière à utiliser ce produit à une fin constante contre les lézards du visage et surtout contre ce terrible ennemi des cellules de la vie, cause primordiale des rides, l'est le, il faut le reconnaître, un moyen ingénieux d'employer, à peu de frais, les précieuses émanations de ce produit coûteux; et c'est, sans inconvénient, le meilleur moyen de combattre les rides, bien supérieur à tout ce qu'on a trouvé jusqu'ici. Fichons donc les Laboratoires Ramey d'arrêter ou d'éviter les rides d'acquiescer eux-mêmes les sels de radium dans leurs produits, vendus sous le nom de *Produits radiacés Ramey* (crème, savon, lait, shampooing), et de nous donner aujourd'hui cette merveilleuse Crème Ramey, qui veloute et parfume le visage, efface vraiment les rides, les fêlures, le rouge du nez, les taches de rousseur, les points noirs, l'acné.

Docteur PHILIPPON.

## LE RADIUM RÉGÈNÈRE L'ÉPIDERME

PLUS DE  
RIDES



TEINT  
VELOUTÉ

# LA CRÈME RAMEY

## RADIACÉE CONTIENT DU RADIUM

**CRÈME radiacée RAMEY**  
*Le Pot, grand modèle* 0 fr. 40  
*Le Pot, moyen modèle* 5 fr. 50  
*Le Tube* 2 fr. 50

**LAIT radiacé RAMEY**  
*Le Flacon* 11 fr. 75

**SAVONS radiacés RAMEY**  
*Savonnette enveloppée* 2 fr. 95  
*La Boîte riche* 8 fr. 50  
*Bath Sapsolo 10 gr. tin* 2 fr. 95

**SHAMPOOING radiacé RAMEY**  
*(avec et sans Quinquina)*  
*Le Sachet pour 1 lit. d'eau* 0 fr. 45  
*Les 12 sachets* 5 fr.

**POUDRE RAMEY (6 teintes)**  
*Bianche - Naturelle*  
*Ocre Africain*  
*Rachel - Rose - Ocre*  
*La boîte, grand modèle* 5 fr. 50  
*Le petit modèle* 3 fr.  
*Le petit modèle* 0 fr. 95

**EN VENTE :**  
chez Coiffeurs-Parfumeurs,  
et Grands Magasins,  
et aux Laboratoires des  
**Produits radiacés**  
**RAMEY**  
5 bis, rue Jean-Jacques  
PUTEAUX (Seine)  
qui enverront franco recommandé  
contre timbre ou mandat  
**GRATIS Notice détaillée**  
et attestations sur  
demande directe aux  
Laboratoires.



# Vanitas vanitatum et omnia vanitas

CRÈME THO-RADIA POUDRE

**THO-RADIA**

EMBELLISSANTES PARCE QUE CURATIVES  
à base de thorium et de radium selon la formule du

**DOCTEUR ALFRED CURIE**  
EXCLUSIVEMENT CHEZ LES PHARMACIENS

POUDRE  
Nettoyant, Vapor  
La Boite 12 50

BROCHURE GRATUITE SUR DEMANDE A THO-RADIA, 20 RUE DES CAPUCINES, PARIS

FIGUILLIO-SADDO

LA SCIENZA AL  
SERVIZIO DELLÀ  
VOSTRA BELLEZZA

Due preparati che daranno alla vostra epidermide freschezza e bellezza:

**CREMA TO-RADIA**  
**CIPRIA TO-RADIA**

05

**RADIUM v. GREY HAIR**

*Who'd dream she was 50?*

50—and not a grey hair to be seen. Wonderful! Yet an absolute fact. Let 'CARADIUM' do for you what it has done for thousands of our clients in all parts of the world. 'CARADIUM' will quickly restore, right from the hair roots, the natural colour, health and beauty to your hair, making you look 10 to 20 years younger.

*Write for Free Hair Book*

**'Caradium' is NOT A DYE**  
CONTAINING RADIO-ACTIVE WATER.

Regular application of 'Caradium' will revivify the colour glands of the hair and cause the natural pigment to flow afresh. 'Caradium' Restorer is just as efficacious in cases of premature or inherited greyness or greyness caused by illness, worry or overwork. It is absolutely sure. So natural is the course of restoration that the use of 'Caradium' is absolutely undetectable.

Grey Hair will never appear if CARADIUM IS USED ONCE WEEKLY AS A TONIC Olive Oil Shampoo Powders. The finest in the world for producing Soft and Glossy Hair, 6d. each. Packets of twelve, 5/-

WARNING.—Ask for Caradium Regd. and see that you get it; imitations are useless.

**Caradium** REGD. Large Size

4/- 7/6

A 4/- size is now available for those only slightly over.  
'Caradium' Hair Restorer is obtainable of all good Chemists, Harrod, Wiggins, Roberts, Selfridges, J. Lyons, White's, Booth, Taylor's Drug Stores, etc., or direct in glass wrapper.  
POST FREE U.K. Invoices 2/6 each 1/6 each.

'CARADIUM' (REGD.), 38, Great Smith Street, Westminster, LONDON



# “Atomic” heat



*Une saine et douce chaleur, radio-active...*

Une laine, souple, élastique, résistante, épaisse et confortable, qu'un traitement physico-chimique a doué d'un remarquable pouvoir : la radio-activité. Chacun connaît les extraordinaires effets de stimulation organique, d'excitation cellulaire, transmis par le radium. Une laine ainsi traitée allie aux avantages propres du textile une indéniable valeur hygiénique. Pour tricoter la layette de Bébé, les lainages des enfants, vos sous-vêtements et vos pull-over, utilisez la

## LAINE ORADIUM

Source précieuse de chaleur et d'énergie vitale, irrétrécissable, infuendable. C'est un Produit de la LAINE MÉDICALE, 20, rue St-Georges, PARIS - Trud. 07-28

La LAINE ORADIUM est vendue chez votre pharmacien au prix imposé de frs : 8.50 la pelote de 50 grammes.

DEMANDEZ LA BROCHURE ET LA CARTE DES COULEURS

*Si votre pharmacien habituel n'est pas encore approvisionné ou n'a pas en stock le couleur que vous désirez, veuillez nous en aviser en nous donnant son adresse et nous nous ferons un plaisir de vous faire parvenir les pelotes de LAINE ORADIUM par son intermédiaire.*



# A driver helper





# Pulchritudo et vigor

***Vous serez belle éternellement  
et toujours jeune..... Madame,***  
 EN PORTANT UNE DEMI-HEURE PAR JOUR LES  
**APPAREILS DE BEAUTÉ**

du **DOCTEUR MONTEIL**  
 Hygiéniste-Spécialiste  
 8, 10, Passage Choiseul, PARIS (Opéra)

**En caoutchouc radio-actif.**

Il<sup>s</sup> préviennent ou suppriment radicalement rides, bajoues, pattes d'oie, double menton, taches, rougeurs, etc.

**Embellissent, rajeunissent,** s'appliquent parfaitement à tous les visages.

La Ceinture "LA DÉSÈSE", entièrement en caoutchouc, s'applique directement sur la peau et fait maigrir rapidement les hanches et le ventre sans médication ni régime.

"LA DÉSÈSE" supprime et prévient toute obésité, tonifie, affine et harmonise le corps.

**SOUTIEN-GORGE assorti : 120 fr.**

**NOUVELLE CRÉATION**  
**Bandes en caoutchouc radio-actif.**  
 Spéciales pour amincir les chevilles.  
**LA PAIRE : 40 frs**

Demander notre Catalogue de Spécialités de Beauté.



Masque idéal. Prix, 30f.



Appareil du Papillon, 20f.



Mentonnière avec cou, 20 f.  
 Mentonnière sans cou, 15 f.  
 Front, 12 f. :: Loup, 15 f.

**Ceinture "LA DÉSÈSE"**  
 entièrement en caoutchouc  
 Taille ordinaire: 150 fr  
 Grande taille 170 fr  
 Mesures à donner : largeur de la taille et des hanches.

**VITA RADIUM SUPPOSITORIES**  
 FOR RESTORING SEX POWER

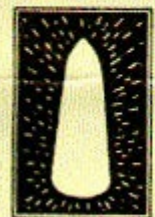

Actual Size of Vita Radium

VITA RADIUM SUPPOSITORIES, for rectal use by men, are tone restorers of sex and energizers for the entire nervous, glandular and circulatory systems. These Suppositories contain a result-producing amount of highly refined soluble RADIUM, carried in a cocoa butter base. The radium is absorbed thru the walls of the lower colon, enters the blood stream and is carried to all parts of the body—to the weakened organs that need its vitalizing aid. After leaving its durably HEALTHY RESULTS, the radium is gradually eliminated in about three days. Vita Radium Suppositories are guaranteed entirely harmless. Recommended for sexually weak men who, however, should use the NU-MAN Tablets in connection for best results. Also splendid for piles and rectal sores. Try them and see what good results you get!

**VIGORADIUM**

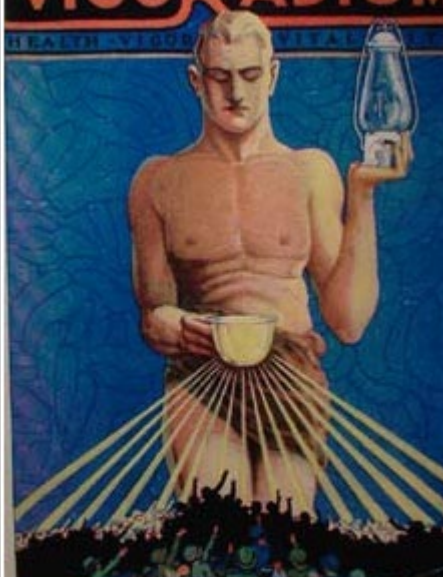

HEALTH — VIGOR — VITALITY WITHIN REACH OF ALL

**VIGORADIUM CORPORATION**  
 115-141 West 44th Street, New York



# Pulchritudo et vigor

***Vous serez belle éternellement  
et toujours jeune..... Madame,***  
 EN PORTANT UNE DEMI-HEURE PAR JOUR LES  
**APPAREILS DE BEAUTÉ**

du **DOCTEUR MONTEIL**  
 Hygiéniste-Spécialiste  
 8, 10, Passage Choiseul, PARIS (Opéra)

**En caoutchouc radio-actif.**

Il<sup>s</sup> préviennent ou suppriment  
 radicalement rides, bajoues,  
 pattes d'oie, double menton,  
 taches, rougeurs, etc.

**Embellissent, rajeunissent,**  
 s'appliquent parfaitement à tous les  
 visages.

La Ceinture "LA DÉESSE", entière-



Masque idéal. Prix, 30f.



Appareil dit Papillon, 20f.



Mentonnière avec cou, 20 f.  
 Mentonnière sans cou, 15 f.  
 Front, 12 f. :: Loup, 15 f.

Demander notes

**VITA RADIUM SUPPOSITORIES**  
 FOR RESTORING SEX POWER

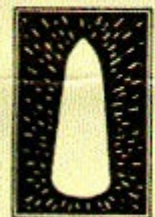

Actual Size  
of Vita Radium

VITA RADIUM SUPPOSITORIES, for rectal use by men, are  
 tone restorers of sex and energizers for the entire nervous, glandular  
 and circulatory systems. These Suppositories contain a result-producing  
 amount of highly refined soluble RADIUM, carried in a cocoa  
 butter base. The radium is absorbed thru the walls of the lower  
 colon, enters the blood stream and is carried to all parts of the body  
 --to the weakened organs that need its vitalizing aid. After leaving  
 its durably HEALTHY RESULTS, the radium is gradually elimi-  
 nated in about three days. Vita Radium Suppositories are guaranteed  
 entirely harmless. Recommended for sexually weak men who, how-  
 ever, should use the NU-MAN Tablets in connection for best results.  
 Also splendid for piles and rectal sores. Try them and see what  
 good results you get!

**VIGORADIUM**



THREE RUBBER PROPHYLACTICS  
 No. 33 Rolled

Sold for protection against disease

**"GET NEXT TO NUTEX"**  
*Ask for them by name*

RADIUM NUTEX are fine quality prophylactics  
 They are carefully inspected and tested.

SOLD IN DRUG-STORES

Manufactured by  
**THE NUTEX COMPANY**  
 Sales Office Phila., Pa.  
 Made in U. S. A.

3 for 50c Doz. \$1.50



# Hot chocolate



# False (?) advertising



## X-Radium Heater

A little marvel of comfort and economy wanted in every home

The X-Radium Heater is, in reality, a neat little stove, four inches high and seven inches in diameter. Gives heat without consuming fuel. Made in two parts: first, a heating pad of stamped steel filled with X-Radium (a chemical substance recently discovered possessing the same affinity for heat that a sponge has for water); second, a stamped steel bowl-shaped stand with asbestos mat in the bottom, into which the pad is placed after being heated. Finely finished, polished and heavily nickel-plated.

No extra cost in heating the X-Radium Heater. Just the gas on the stove or range (coal, wood, gas, gasoline or oil) and in twenty minutes it will be hot and keep hot for two hours.

Keeps the coffee, soup, vegetables, meat and pastry hot, keeps the flat-irons hot, keeps anything hot. Takes the place of the hot water bag and is the greatest hot water on earth. Will last a lifetime. It is everybody's necessity and everybody can have it. Price Only \$2.50 (East of Missouri River).

**Our Free Trial Offer.**—Order the X-Radium Heater through your local dealer. We will send it to him, transportation prepaid, and instruct him to allow you to try it for ten days. If satisfactory pay him \$2.50. If you are not satisfied, return it to the dealer. You have no risk in the matter. This trial offer shows our confidence in the merits of the X-Radium Heater. So please have no hesitation in taking advantage of it.

Rovelsy Manufacturing Company, Department F,  
JACKSON, MISSISSIPPI, U. S. A.

When you write advertisers please mention Code H4444444444.

# RADIUM SPRAY

THE NEW  
**Combination Bug Killer, Disinfectant and Furniture Polish**

Guaranteed by Grocers and Druggists  
 to Kill All Insects and Vermin

TRY IT AT OUR EXPENSE

MANUFACTURED BY  
**RADIUM SPRAY CO., Inc.**

114 THIRD AVE. SOUTH SEATTLE, WASHINGTON





# All that glitters is not gold



The Radium Corporation claimed that the deaths were the results of sexually transmitted diseases. To combat these accusations, the bones of some of the already dead lip pointers were exhumed for study. Their skeletons were glowing.

# “A Cure for the Living Dead”

tioned as a candidate for the new office. Has \$

---

**EBEN M. BYERS DIES OF RADIUM POISONING**

Noted Sportsman, 51, Had Drunk a Patented Water for a Long Period.

---

**CRIMINAL INQUIRY BEGUN**

Pittsburgh and New York Steel Man Won Amateur Golf Title— Was Prominent on Turf.

---

Eben MacBurney Byers, wealthy iron manufacturer of Pittsburgh and New York and internationally known

Special Cab  
DUBLIN, moderate Valera's E forced the terms of Government and the la  
The fina which the prove tom ent from t by Mr. serious dif the Minis sidered M truculent known to whole doc and whil abolition of the an friendly  
Cou  
Meanw making sions reg tariff po Sean L

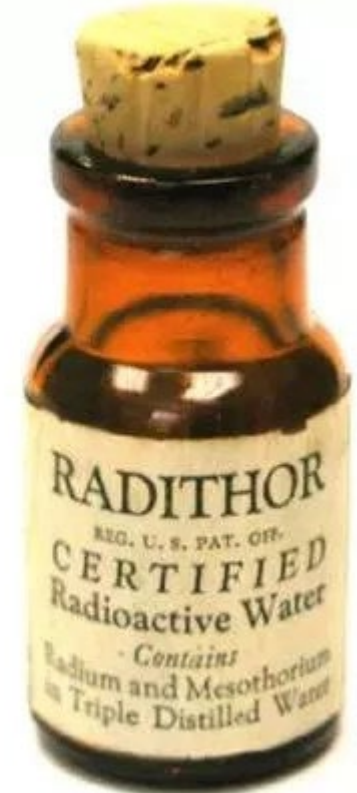

~37 kBq of  $^{226}\text{Ra}$  and  
~37 kBq of  $^{228}\text{Ra}$





I benefici sono efficaci nel trattamento di:

- infiammazioni dell'apparato respiratorio con l'inalazione di vapor acqueo;
- malattie di tipo reumatico e uricemico;
- interazione benefica con la pelle;
- affezioni della sfera genitale;
- infiammazioni e disturbi dell'apparato digerente;
- attività di riabilitazione post-traumatica da fratture.



# An italian spa

## Caratteristiche acqua termale

Aspetti e caratteri organolettici	limpida, inodore, incolore, calda
Temperatura aria al prelievo	12,0° C
Temperatura acqua al prelievo	27,7° C
Ph	7.2
Conducibilità elettrica specifica a 18° C	US 282
Residuo fisso a 180°C	190 mg/l
Ossigeno consumato sec. Kubel	0,32 mg/l
Ione Ammonio (NH3 +)	0,015 mg/l
Ione Nitrico (NO3 -)	0,30 mg/l
Ione fosforico (PO4 -)	0,03 mg/l
<b>Gas disciolti in un litro di acqua:</b> (riport. a 0° C e 760 mm Hg)	
Anidride Carbonica	3,85 ml
Ossigeno	3,08 ml

## Sostanze disciolte in un litro d'acqua espresse in ioni:

Sodio (Na+)	2,0 mg
Potassio (K+)	0,5mg
Magnesio (Mg++)	12,16 mg
Calcio (Ca++)	48,90 mg
Ione bicarbonico (HC03)	196,56 mg
Ione cloridrico (Cl-)	0,80 mg
Ione solforico (SO4)	6,90 mg
Ione p.m. silicico (SiO2)	4,90 mg
Ione fluoridrico (F-)	0,43 mg
Litio	0,0006 mg
Alluminio	0,032 mg
Manganese	0,0016 mg
Ferro totale	0,010 mg
Rame	0,005 mg
Zinco	0,043 mg
Stronzio	0,23 mg
Radioattività (gas Radon)	picoCurie/l 229 Unità Mache/l 0,75

Analisi del Laboratorio Chimico Provinciale di Trento



# Spa

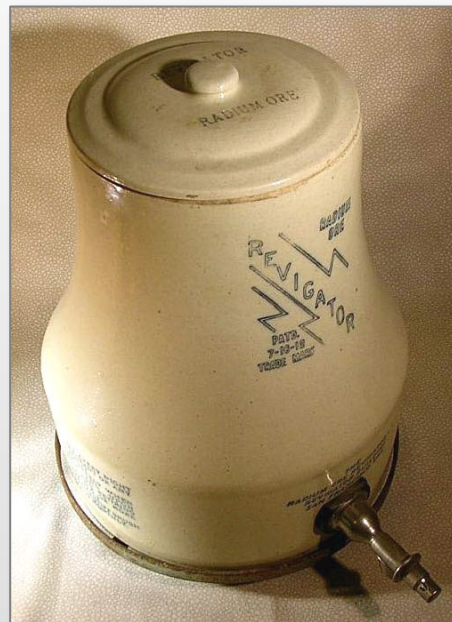
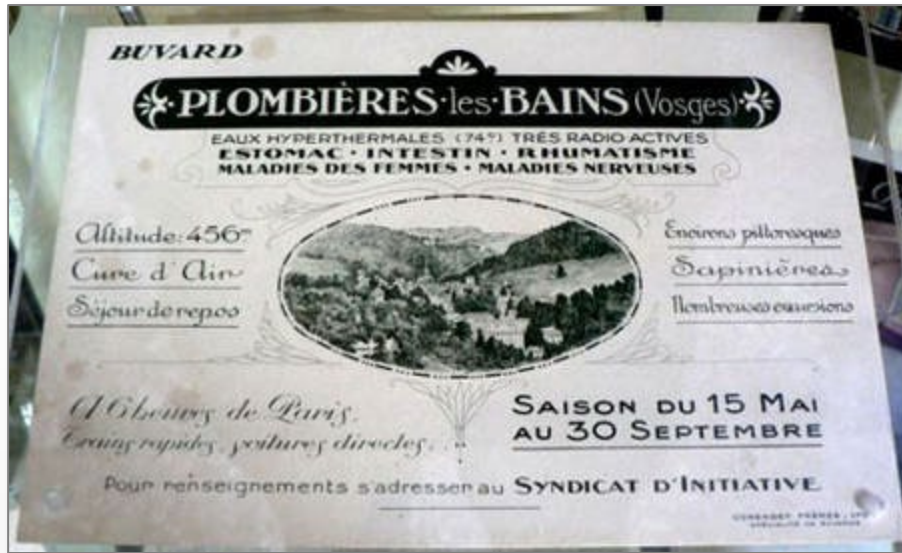

# Radioactive water

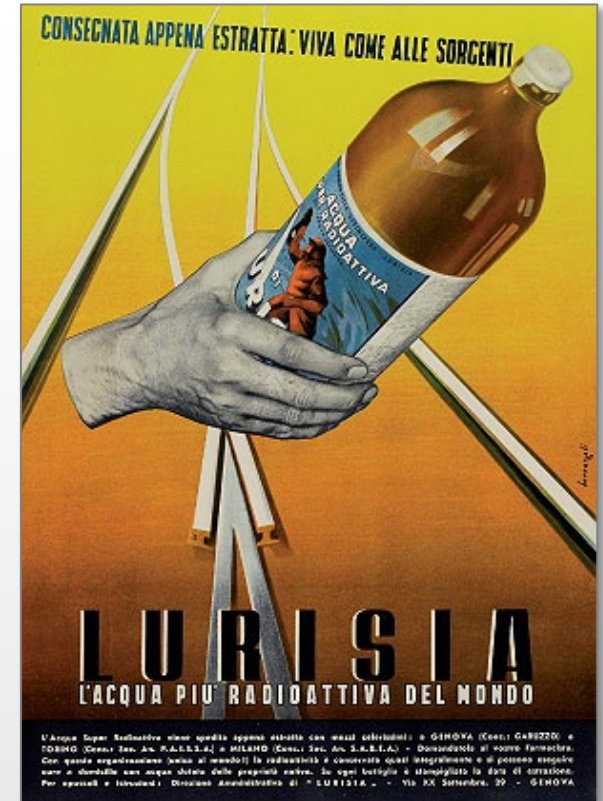
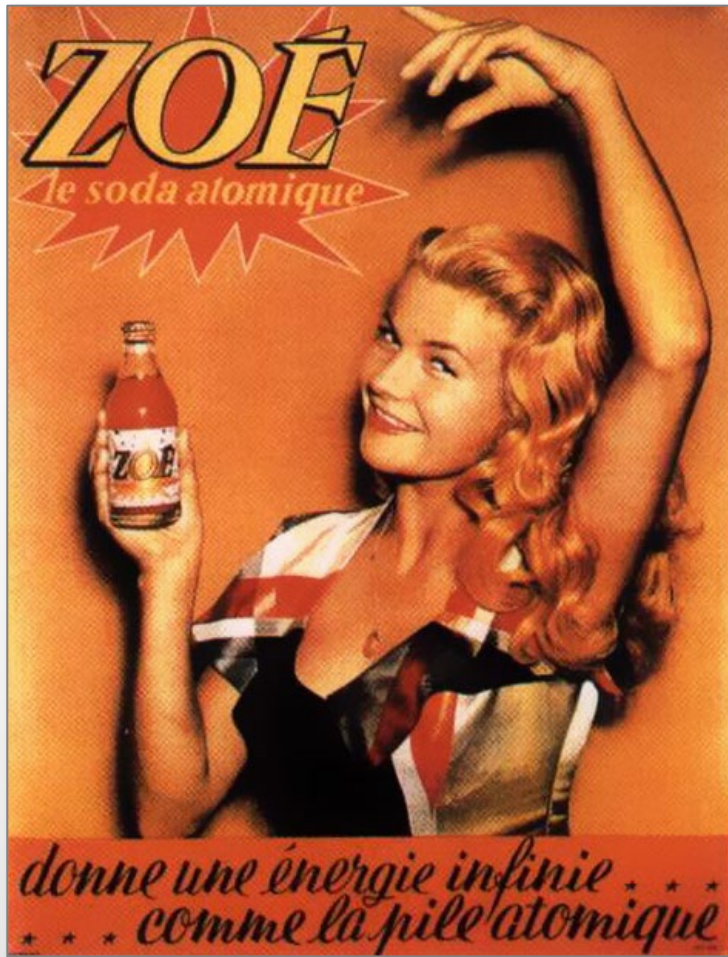

# Physics and Medicine

1898

Maria Salomea Skłodowska  
and Pierre Curie

“discovery of spontaneous radioactivity”

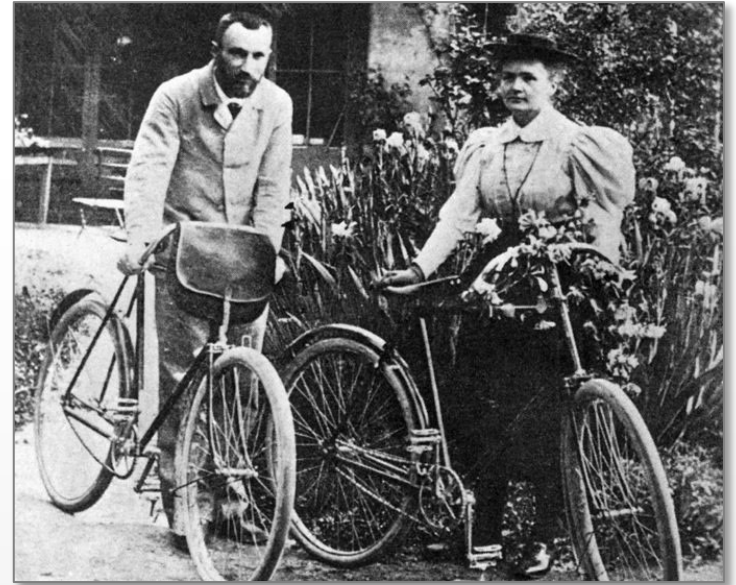

PHYSIOLOGIE. — *Action physiologique des rayons du radium.*  
Note de MM. **HENRI BECQUEREL** et **P. CURIE.**

1901

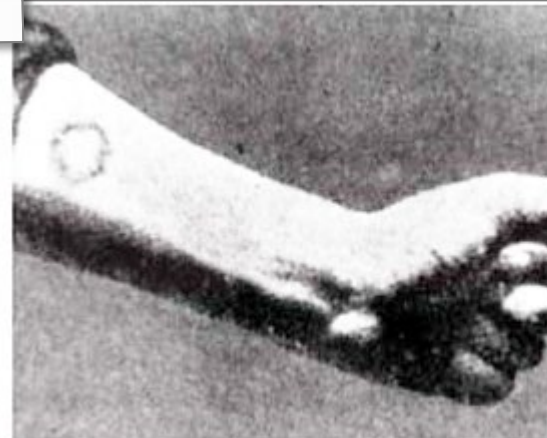

Pierre Curie  
1859-1906

Brûlure du bras de Pierre Curie

# Physics and Medicine

1906 (translated in 1959)

The “Law of Bergonie and Tribondeau”

“X-rays are more effective on cells which have a greater reproductive activity; the effectiveness is greater on those cells which have a longer dividing future ahead, on those cells the morphology and the function of which are least fixed. From this law it is easy to understand that roentgen radiation destroys tumors without destroying healthy tissues.”

Interpretation of Some Results of Radiotherapy and an Attempt at Determining a Logical Technique of Treatment<sup>1</sup>

De Quelques Resultats de la Radiotherapie et Essai de Fixation d'une Technique Rationnelle

J. BERGONIE AND L. TRIBONDEAU

1923

Hevesy György

He used the radium-D ( $^{210}\text{Pb}$ ) as tracer

LIII. THE ABSORPTION AND TRANSLOCATION OF LEAD BY PLANTS.

A CONTRIBUTION TO THE APPLICATION OF THE METHOD OF RADIOACTIVE INDICATORS IN THE INVESTIGATION OF THE CHANGE OF SUBSTANCE IN PLANTS.

By GEORGE HEVESY.

*From the Institute of Plant Physiology of the Agricultural High School, and Institute of Theoretical Physics of the University, Copenhagen.*

(Received May 4th, 1923.)

# Physics and Medicine



1934

Enrico Fermi

Irène Joliot-Curie and

Frédéric Joliot

“synthesis of new radioactive elements”

*Nature, volume 133*

1935

Hevesy György

Ole Chiewitz

With  $^{32}\text{P}$ : “Radioactive Indicators  
in the Study of Phosphorus  
Metabolism in Rats”



# Physics and Medicine

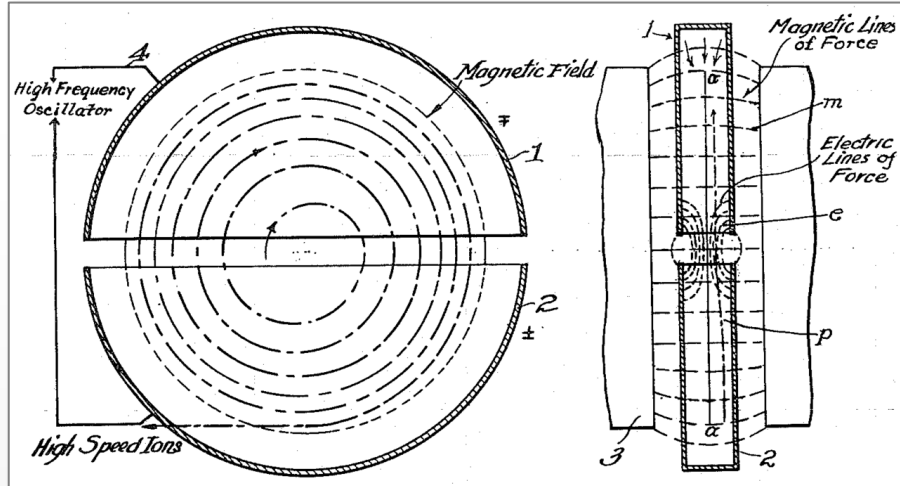

1934

Ernest Orlando Lawrence  
Patent: "Method and  
apparatus for the acceleration  
of ions"

1937

John Hundale Lawrence  
used phosphorus-32 isotopes to  
treat polycythemia vera



1938

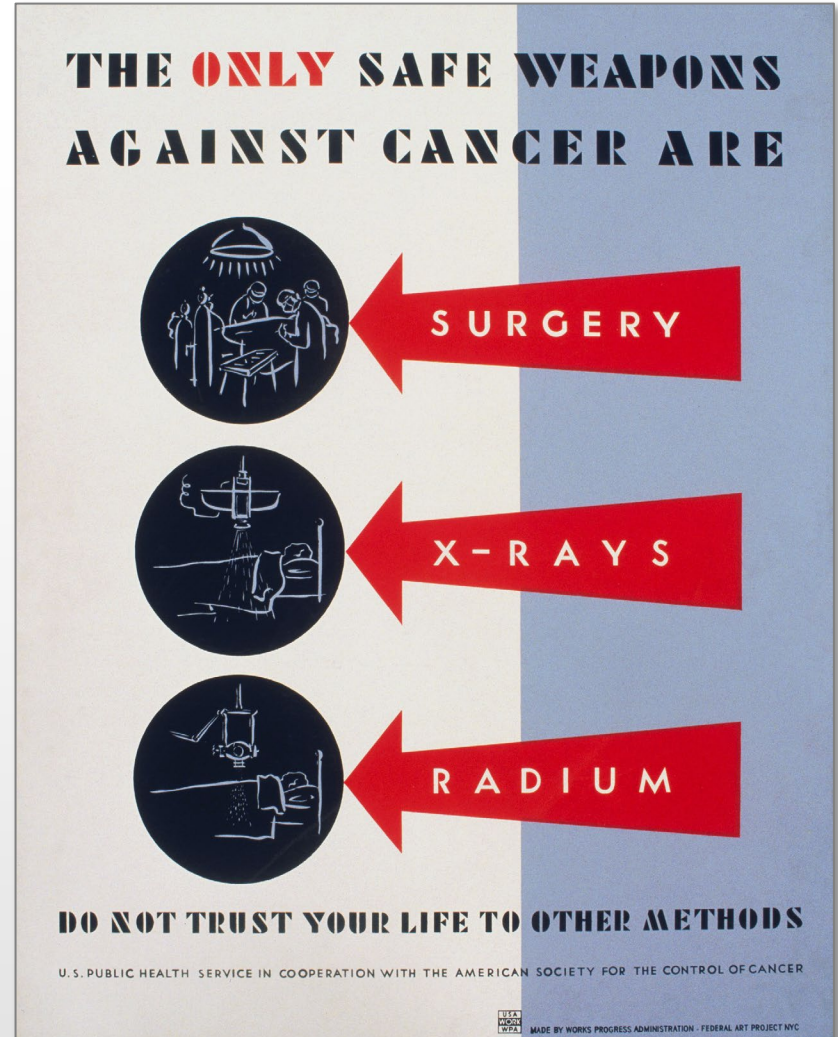
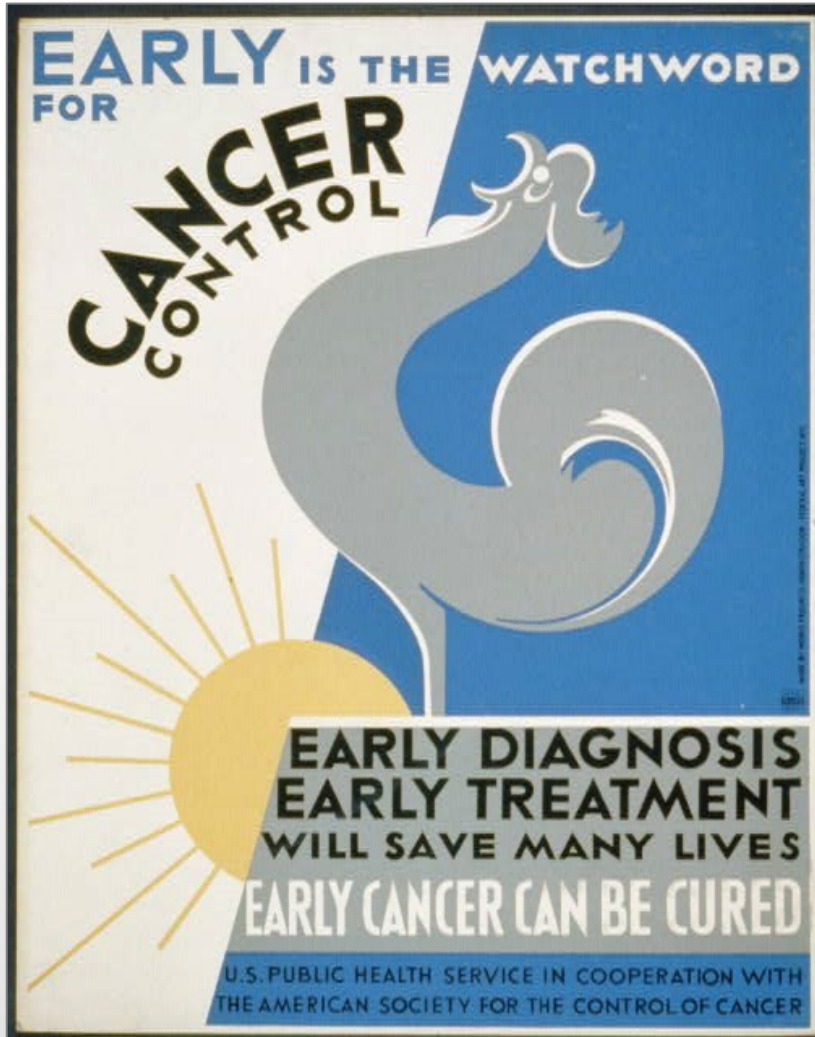

*Chemotherapy is first discovered in the 1940s*





# Today - Cyclotron: charged particles

Extracted Particles	Energy range (MeV)	Highest possible current ( $\mu\text{Ae}$ )
$\text{H}^+$	35 - 70	375 x 2
${}^4\text{He}^{2+}$	70	70
$\text{HH}^+$	35	50
$\text{D}^+$	15 - 35	50 x 2



# Today: Nuclear reactor: neutrons

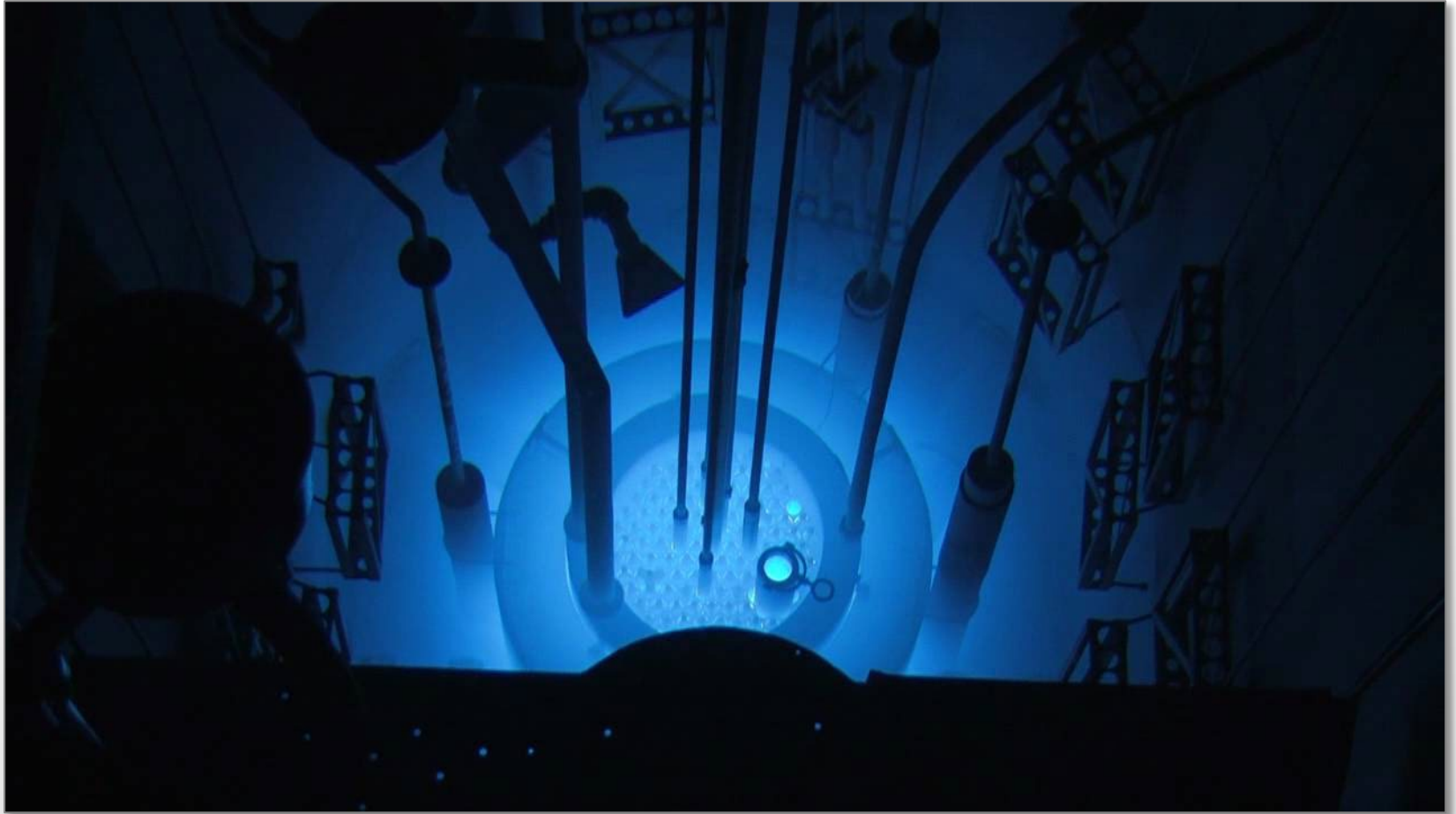

# Today - Therapy

## HOW DOES RADIOTHERAPY WORK?



**EXTERNAL BEAM RADIOTHERAPY**

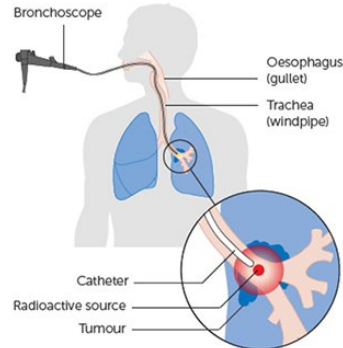

**BRACHYTHERAPY**

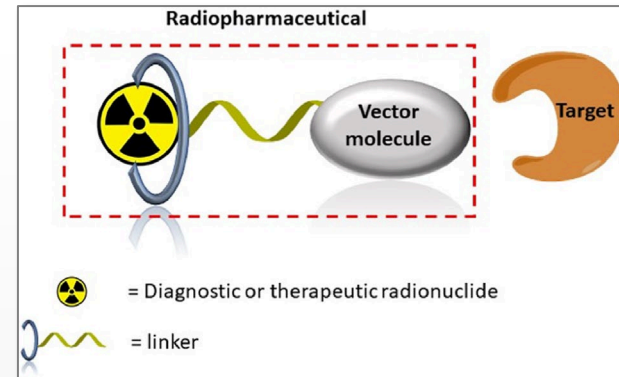

### Radiotherapy v Proton beam therapy

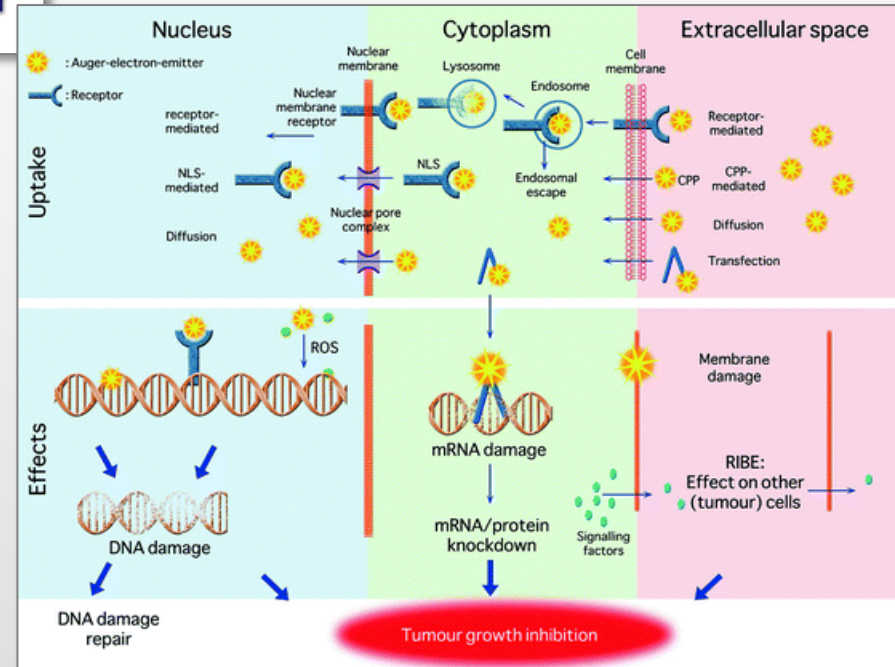
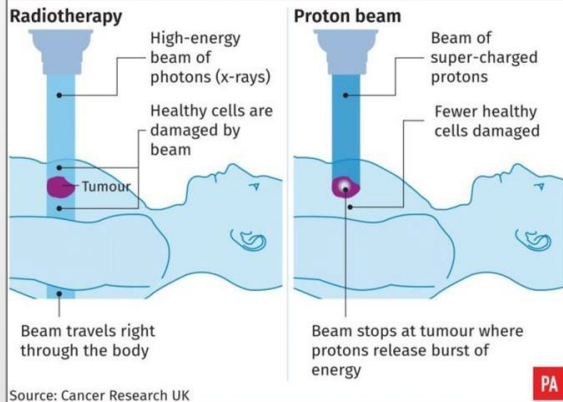

# Nuclear Medicine

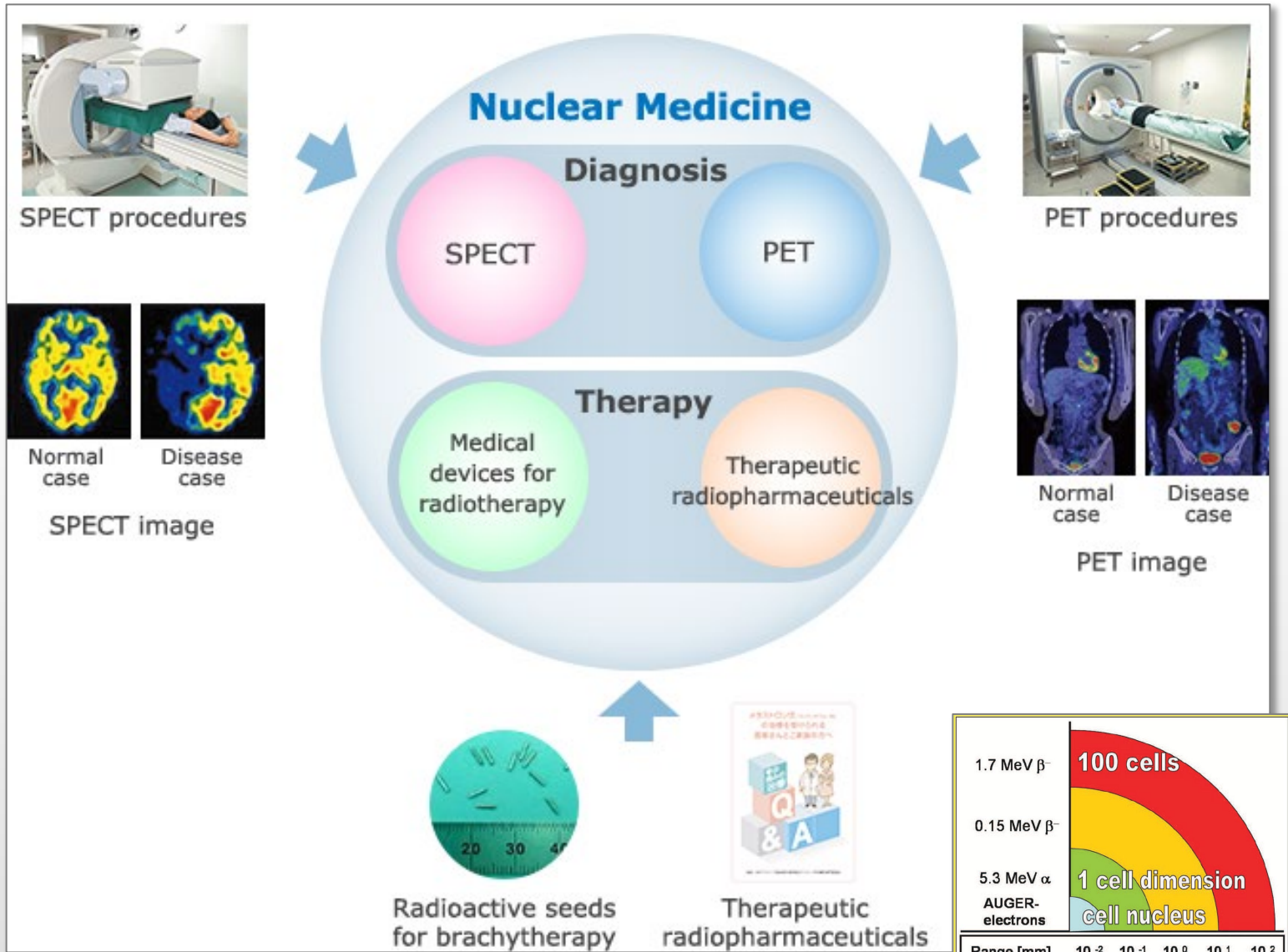

Over 10'000 hospitals worldwide use radioisotopes in medicine, and about **90%** of the procedures are for **diagnosis**.

In the USA there are over 20 million nuclear medicine procedures per year among 311 million people, and in Europe about 10 million (with 2 million of these being therapeutic) among 500 million people.

The use of radiopharmaceuticals in diagnosis is growing at ~10% per year.

The global market for Nuclear Medicine Radioisotope estimated at US\$7 Billion in the year 2020, is projected to reach a revised size of US\$11.6 Billion by 2027.

North America is the dominant market for diagnostic radioisotopes with close to half of the market share, while Europe accounts for about 20%.

# Patient with bone marrow mets from a pancreatic G2 NET treated with PRRT with $^{177}\text{Lu}$ -DOTATATE (25 GBq)

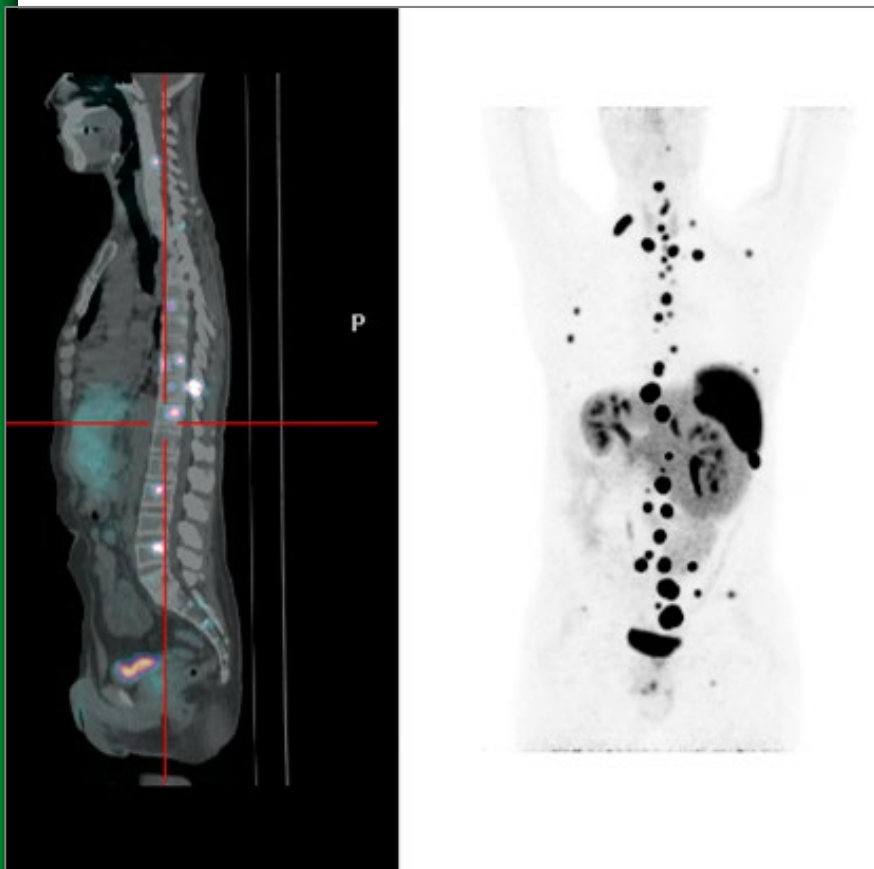

Basal  $^{68}\text{Ga}$ -DOTATOC PET/CT

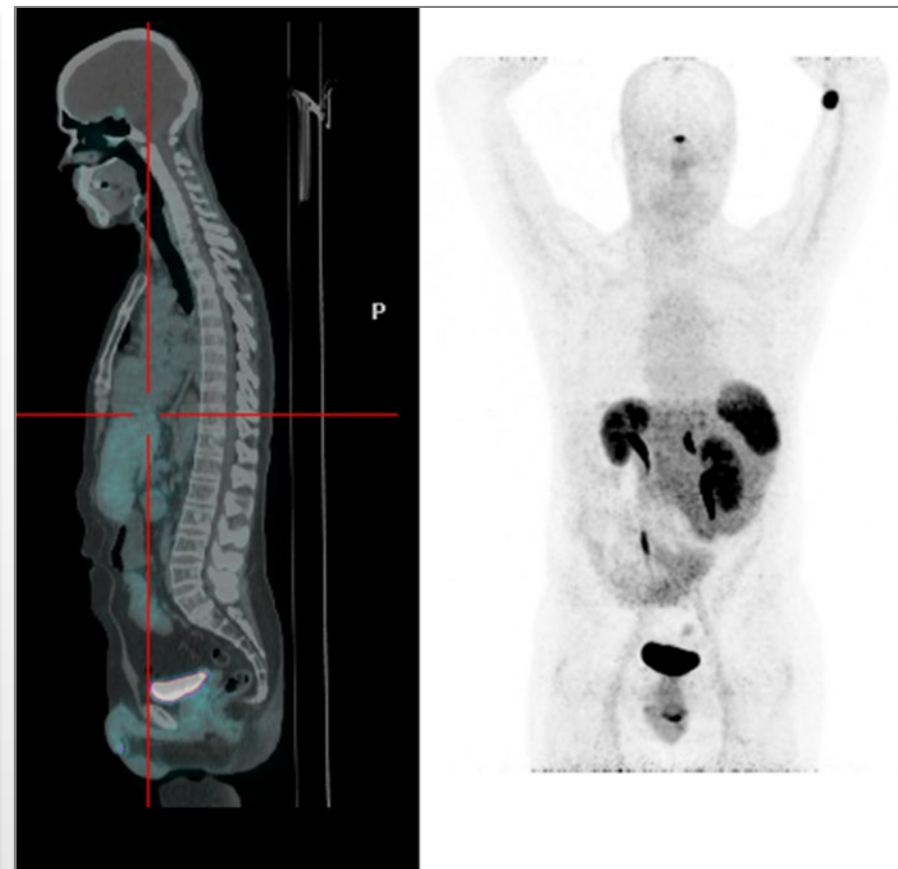

Final  $^{68}\text{Ga}$ -DOTATOC PET/CT

# Per saperne di più



## F\*\*\*ING GENIUS LA RIVOLUZIONE DELLA SPECIE

<https://storielibere.fm/fottuti-geni/>

Ep. 08 | Marie Curie

Ep. 05 | I ragazzi di via Panisperna

### Atomi per la salute

Documentario trasmesso da Dixit  
Scienza di Rai educational

<https://youtu.be/K3VsaD4L4TI>

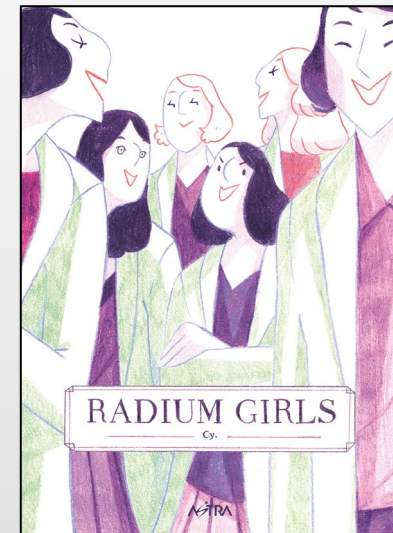

# Thank you for your attention

