



# *SPHINX*

*Structure Probing by Holographic Imaging at Nanometer scale with X-ray lasers*

*Consiglio dei Laboratori – Preventivi 2024*

*M. Iliescu, INFN-LNF*

**6 Luglio 2023, Frascati**

# Qualitative comparison of X-ray imaging techniques

## X-ray imaging

- low contrast for samples with similar compositeness (biological cells, multilayer nano lithography, etc.)
- bi-dimensional reconstruction using the amplitude information
- 2D phase contrast imaging (with reduced magnification)
- 3D info from long, multiple exposures (tomography) with  $\sim 10^2$  nm resolution and no timing information or from diffractive patterns, often requiring polymer embedding, staining or freezing (in vitro) or averaging multiple similar samples
- large samples and organisms can be investigated

## XRF imaging

- bi-dimensional, micrometer resolution
- provides elemental compositeness info

## X-ray holography (absorption/phase contrast)

- direct tri-dimensional reconstruction
- on **FELs**, allows femtosecond time resolution, providing real-time info of the structure, possibility to monitor molecular processes
- small samples (biologic cells, microstructures, nanobots)

## XRF holography

- atomic resolution ( $\sim \text{\AA}$ ), works on regular patterns

# Basic holography method

## Exposure

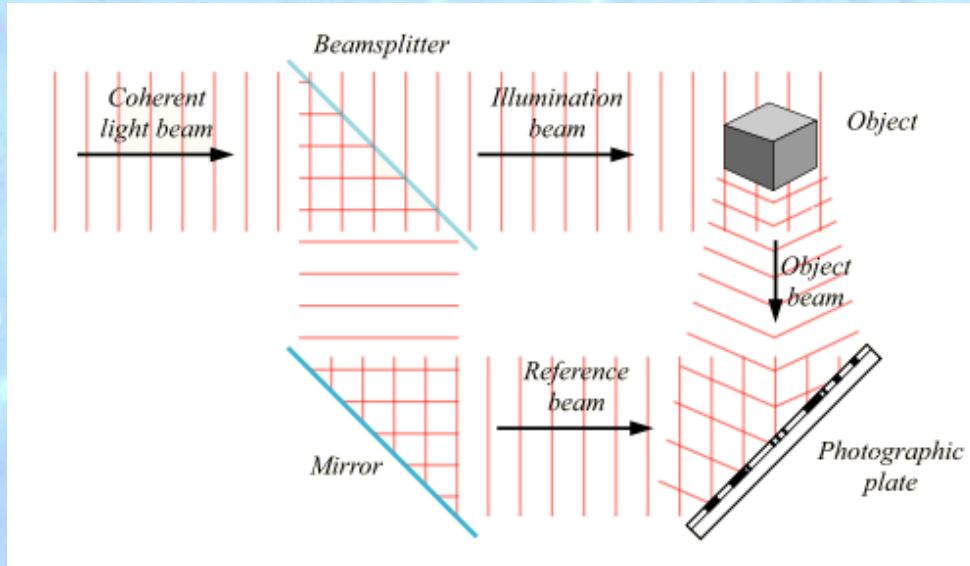

## Reconstruction

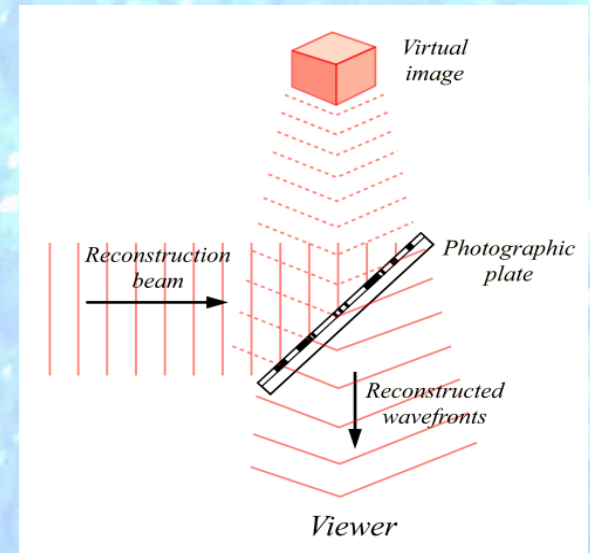

$$|E_O + E_R|^2 = E_O E_R^* + |E_R|^2 + |E_O|^2 + E_O^* E_R$$

$E_O$  - object field,  $E_R$  - reference field

$$E_R(x, y)h(x, y) = \left[ h_0 + \beta\tau(a_R^2 + a_O^2) \right] E_R(x, y) + \beta\tau a_R^2 E_O(x, y) + \beta\tau E_R^2(x, y) E_O^*(x, y)$$

$h(xy)$  - hologram function,  $\beta$  - slope amplitude transmittance vs. exposure

# Digital holography

*In the case of digital holograms, the photographic plate is substituted by CCD sensors, while reconstruction is performed by computing the interference. In particular, in digital holographic microscopy, beam condensers/expanders are required, for matching the beam-sample-sensor sizes.*

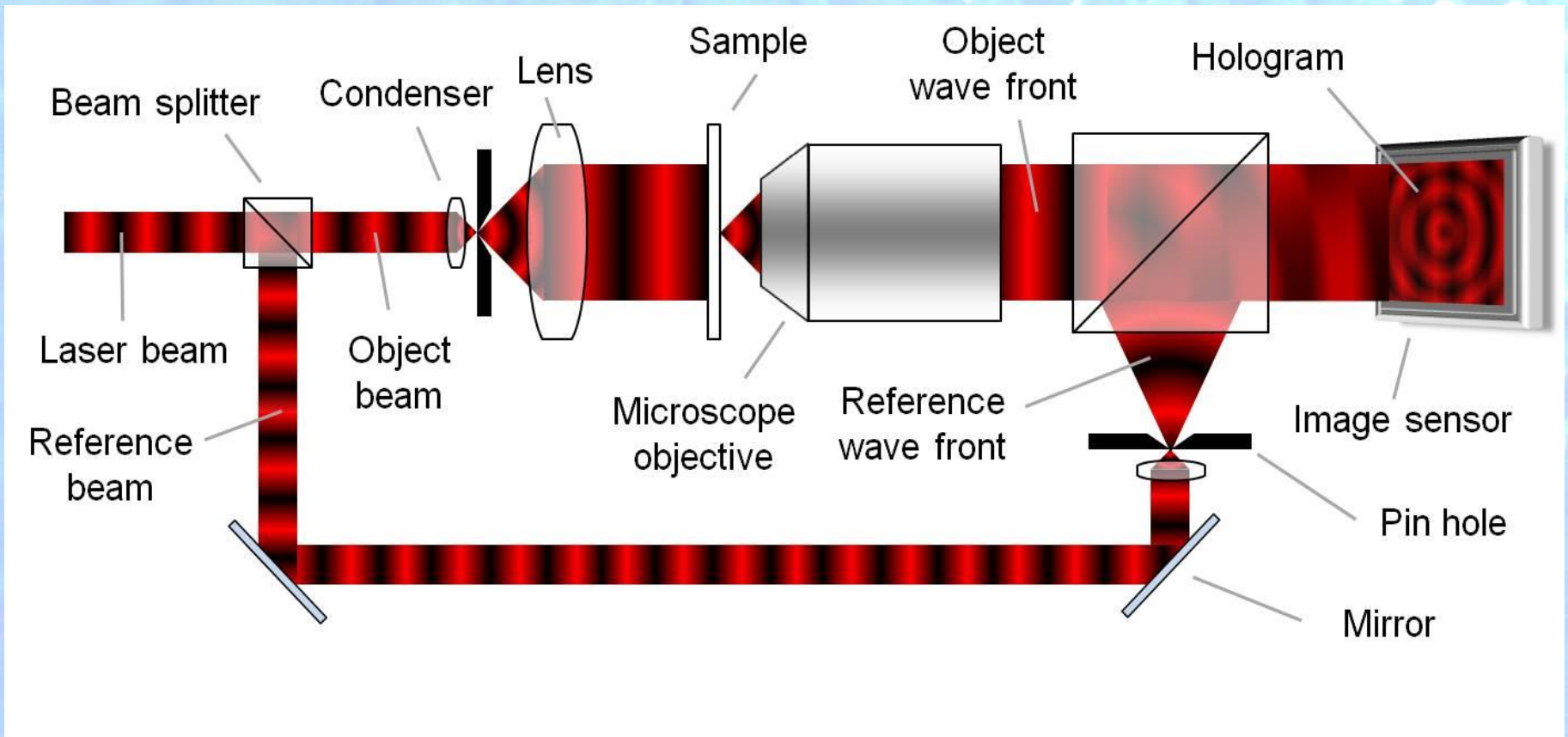

# Basic setup configurations for X-ray digital holography

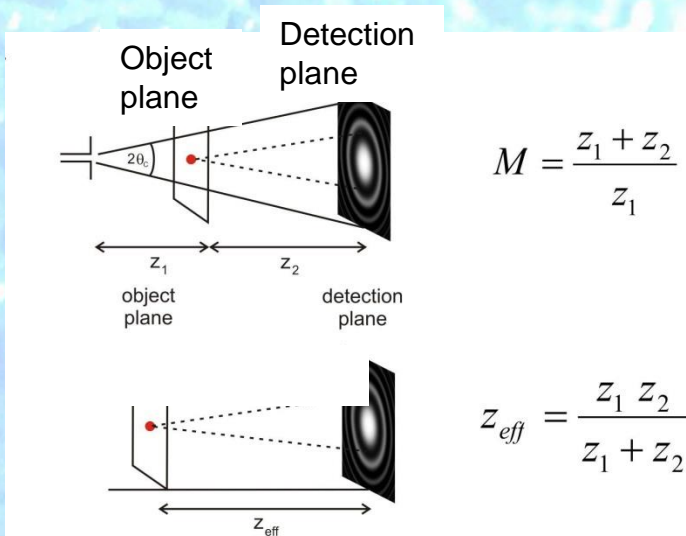
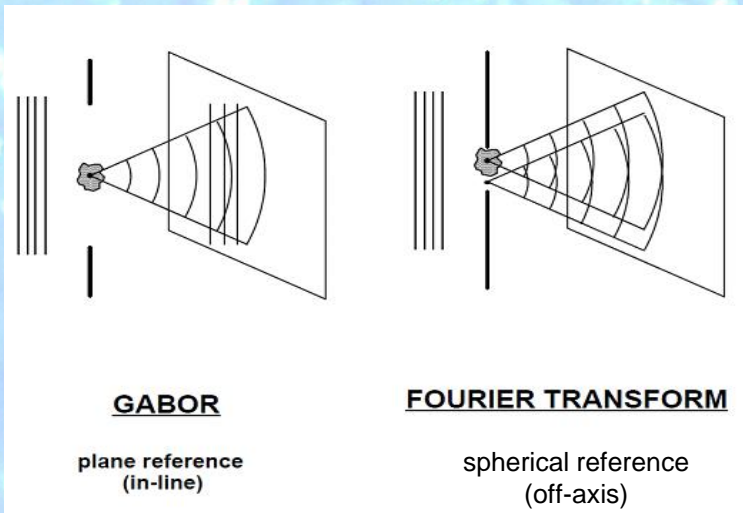

Optimizing Z for best sampling frequency:

$$Z = 1.22 * N * \delta r * P_s / \lambda$$

Z exposure distance  
 $\delta r$  minimal probe element

N number of pixels

$P_s$  pixel size

$\lambda$  wavelength

*low flux trough the sample (image beam) Higher energy (resolution) smaller pinholes, flux drop*

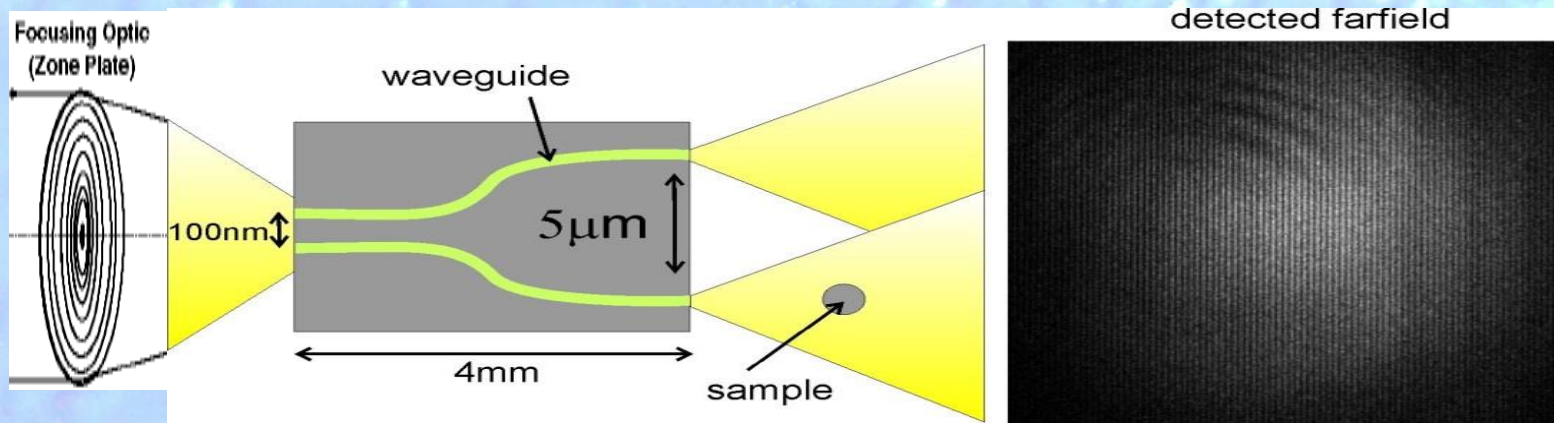

*Beam focusing and splitting, coherent source re-created by the small output aperture (nm) very low flux trough the sample, small setup sizes, long exposures*

# Solutions adopted in the low-energy range

## Absorption XRH water window (300-500 eV)

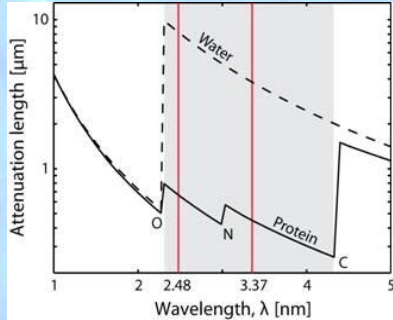

Contrast for structures based on C,N and heavier elements

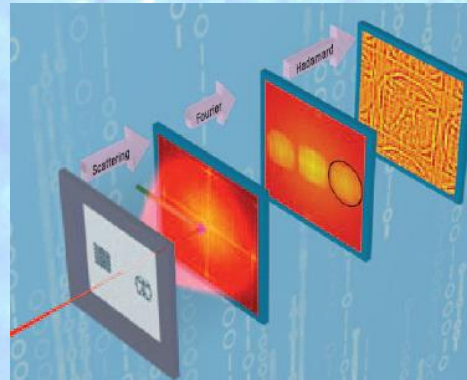
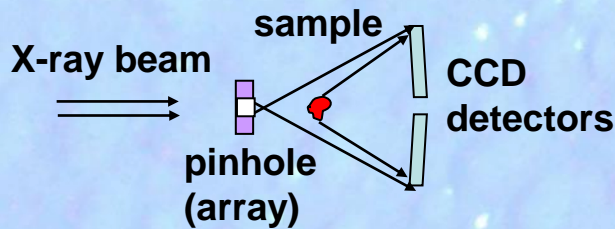

*Array of Hadamard pinholes  
~50-75 nm resolution  
Marchesini S. et. al.  
Nature Photonics V 2 Sept 2008*

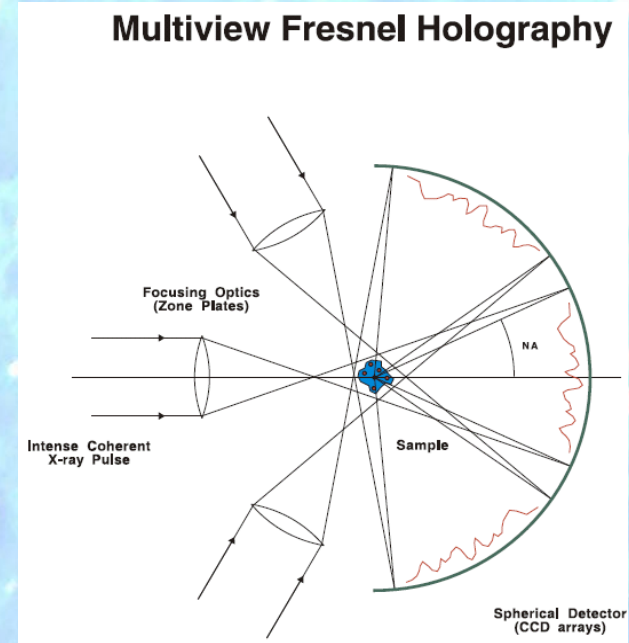

**Absorption->shadow  
Multiview needed to  
explore the whole 3D structure**

-large angles -> near detector placement -> pitch and wavelength limited resolution

-pinhole limited flux

# **Experimental difficulties in *X-ray digital holography*** (not encountered in the visible range)

- **X-ray sources are complex; the degree of spatial coherence is limited and goes inversely with the flux and the energy (pinhole or focus size / distance), while good temporal coherence is achieved only with lasers**
- **high diffraction angles for absorption-based imaging, wide sensors should be used (detector pitch and size limit the resolution)**
- **sample size limited by the strong illumination needed**
- **shielding effect in the "water window" (further reducing the illumination)**
- **special optics (X-ray mirrors, Fresnel lenses), efficiency strongly drops with energy**
- **pinholes limiting the flux (size varying inversely with the energy)**
- **samples might be altered during exposure by vibration, ionization and heating**
- **long exposures are resolution-limiting, due to system instability (vibrations, thermal)**

# ***Key elements for successful hi-res holography***

- Higher energy -> pushing lower the diffraction limit
- Beam focusing on the sample (illumination)
- Magnification
- Beam splitting ("clean" reference)
- Small diffraction angles, allowing far detector placement and therefore, lower "grain". This is just apparently in contradiction with the first request (energy); switching from absorption to **phase contrast** reduces, for most biological samples (given the small internal variations in the refractive index), the characteristic angles by ~ 3 orders of magnitude
- Large detectors with small pitch (~25 um) placed at large distances
- Coherent, short time, high pulse intensity X-ray sources (to allow in-vivo imaging)
- Geometry / optics matching all the above constraints



# Coherent X-ray sources

**Conventional sources** – monochromators – lenses - pinholes: extremely low flux, Doppler-broadening, sample internal dynamics and vibrations induce displacements larger than the investigated structure elements

**Undulators** on synchrotron beamlines: limited degree of coherence, low instantaneous intensity

**Pulsed X-ray fluorescent sources**, activated by high power lasers: high divergence, Doppler

**Amplified Stimulated Emission (ASE) in plasma capillary columns or plasma electrons in microundulators (still under prototyping phase)**

**FELs**

- high brilliance,  $10^{10}$ - $10^{14}$  ph/pulse (**SASE**)
- coherent (high spatial, fair temporal coherence, improved by self-seeding)
- low divergence
- very short pulses (from 5 to 300 fs)

By eliminating the effect of vibrations and internal movement, inducing image smearing, the interference pattern becomes independent of sample degradation under incident radiation and therefore allows in vivo studies and pinning up ultra-fast processes

# ***Current FEL-XFEL status***

## **Operational FELs:**

- SACLA at RIKEN, (up to 15 keV,  $\sim 5 \cdot 10^{13}$  ph/pulse, 60 Hz)
- LCLS at SLAC (480 – 9500 eV,  $10^{13}$ - $10^{12}$  ph/pulse, 60-300 fs, 120 Hz)
- FLASH at DESY (300 eV, up to 1 keV harmonics,  $10^{12}$  ph/pulse, 10-100 fs)  
(LCLS and FLASH already realized XRH applications)
- FLASH II at DESY (up to 620 eV)
- European XFEL (DESY) 450 eV to 25 keV,  $10^{14}$  ph/pulse, 27000 Hz, coherence time 0.2-0.88 fs
- XFEL at PSI (3 lines, up to 12.4 keV,  $5 \cdot 10^{12}$  ph/pulse, 20 fs, 100 Hz)

## **Italian FELs:**

- SPARC FEL at LNF Frascati (to date up to 30 eV)
- FERMI FEL2 at ELETTRA Trieste (124 eV,  $\sim 10^{11}$  ph/pulse)

**FELs under design/commissioning:** LUND FEL, PAL XFEL (12 keV), EuPRAXIA

# ***Current project***

**Goal:** to improve by one order of magnitude the current resolution limit of XRH, reaching the few nm range full 3D (no shadows) and to allow in-vivo ultrafast exposures.

## **What we cannot use (efficiently):**

-Pinholes, masks: small surface, low energy range

-Pair of capillary waveguides: provide a low intensity beam

-Fresnel lens or mirrors used to focus are "perfect optics"; in phase contrast regime they cannot provide beam splitting (reference and object, crossing the sample) and overlap on the same detector area. Being the diffraction angles extremely small ( $\mu\text{rad}$ ), the sample "shadow" will fall on a region unexposed to a reference.

Moreover, if focusing is used to obtain a coherent source (pinhole-like), the sample must be placed far away, so a low flux of photons will cross it.

# Main ideas:

Capillary optics, XFEL beam, large array (Fresnel configuration) of deeply depleted, low pitch, cryogenic CCDs, placed far away from the sample, slow readout mode.

Polycapillary half-lenses will grant:

- coherent (waveguide) propagation
- intensity gain by focusing

- magnification

- beam splitting

- being imperfect optical elements, their divergence is not exclusively driven by the focal length but mainly by the single fiber output. **This allows the overlap of the 2 "beams" on the same detection area**

- good match between divergence (tens of mrad), detector and pixel size, distance and characteristic phase contrast diffraction angles (urad)

FEL X-ray beam

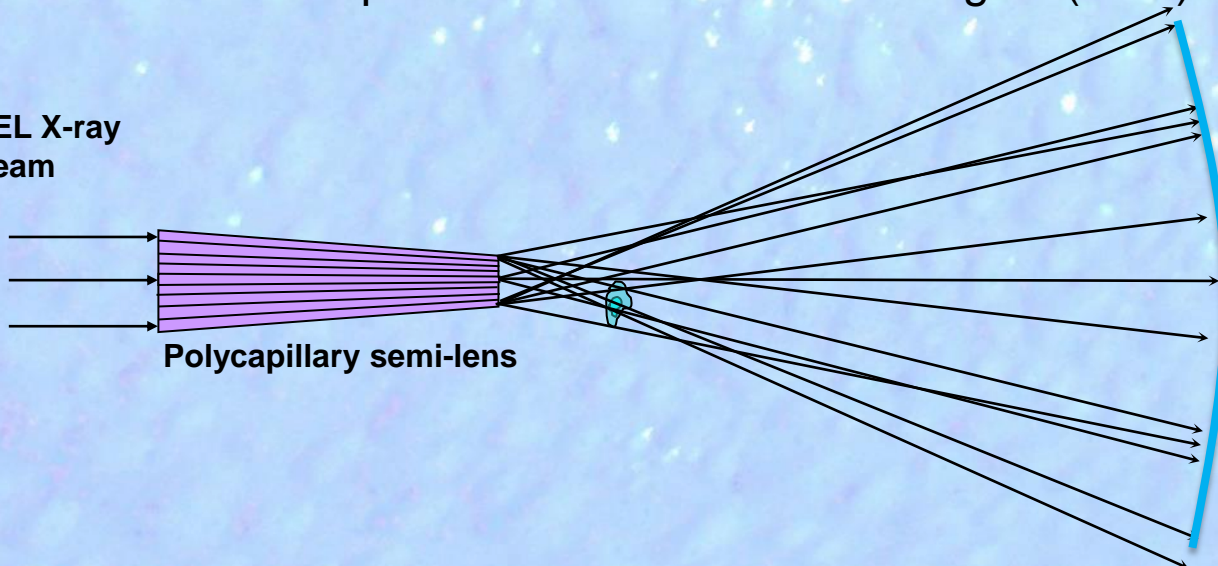

# Deeply depleted X-Ray CCDs

## Electrode structure

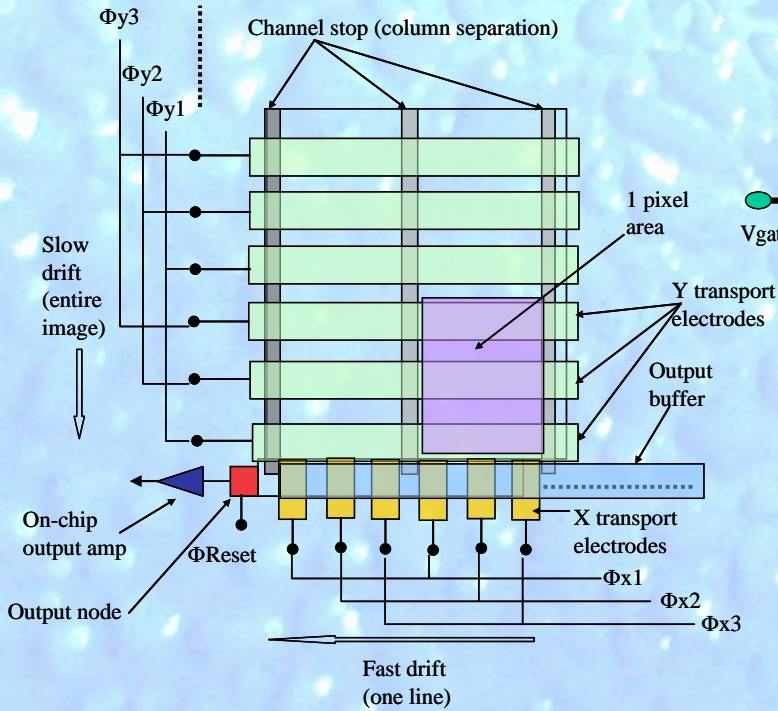

## Electric field amplitude under a polarized electrode

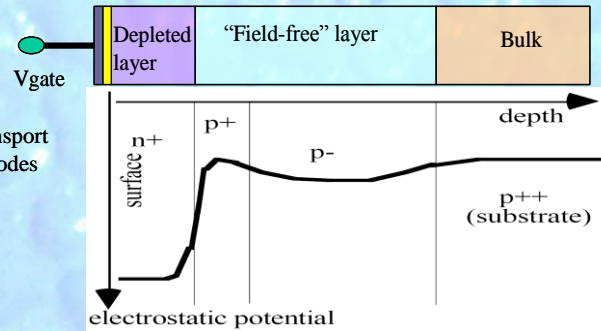

## Quantum efficiency

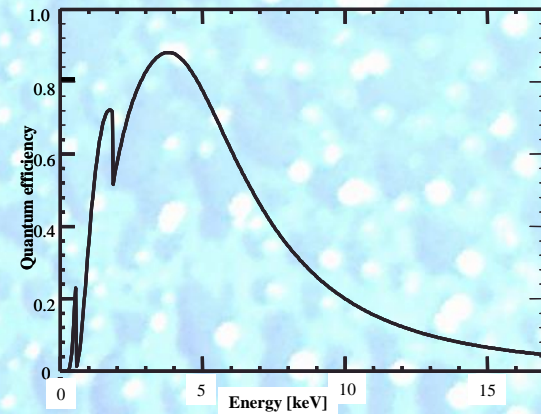

## Charge transfer clocking

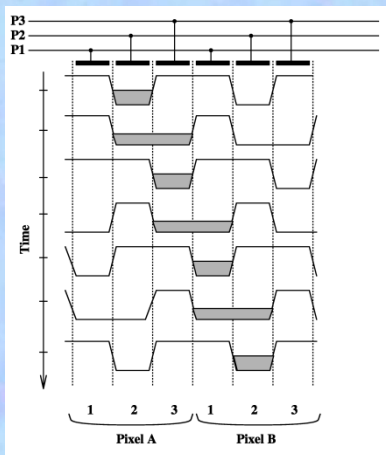

## Background rejection by topological selection of single pixels

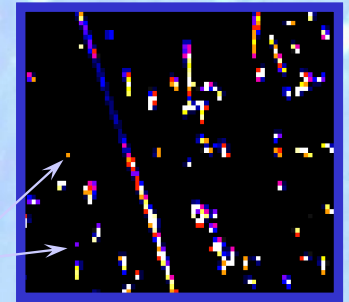
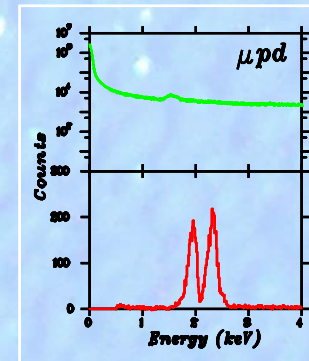
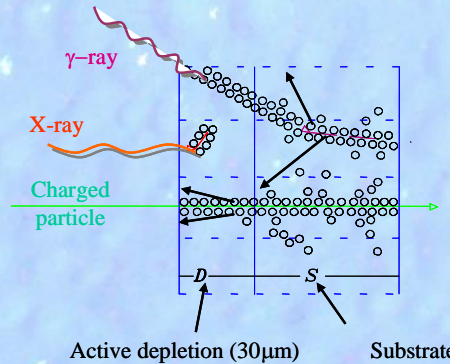

# Working conditions

**Energy range: 3-6 keV, in order to push the resolution by 1 order of magnitude, still maintaining a significant refractive index (above 15 keV becomes compatible to unity)**

**The deeply depleted CCDs have very good Q.E. in this range (60-90%).**

**Slow readout mode with cryogenics: allows reading images with few photons/pixel (1 to 10) without charge transport inefficiency "trails".**

**Some order of magnitude estimates for a 30 m baseline:**

**Fiber divergence 20 mrad -> 30m baseline -> ~20-30cm detector size (border beams partially lost) -> ~100 Mpixel, for a pitch of ~ 25  $\mu\text{m}$  (minimum size to have good depletion and low escape) - good enough for starting doing holography**

**Low refractive index differences inside the sample -> ~  $\mu\text{rad}$  diffractive angles -> 30 m -> 30  $\mu\text{m}$  pixel for a good "Shannon" sampling**

**Phase contrast (transmission) eliminates the "shadow effect", allowing full 3D structure investigation with a single exposure**

## ***Frascati XRH project premises***

- Good knowledge in cryogenic silicon detector operation and readout systems development**
- Direct collaboration with X-ray specialists working in sample analysis (Frascati LNF and DIAMOND synchrotron groups), X-ray optics and nanotechnology development (X-Lab) and FEL/XFEL projects**
- Availability of a large part of necessary instrumentation and detectors (deeply depleted CCDs, cryogenics, electronics and lab. equipment)**
- A team fulfilling necessary competences required by the practical project implementation**

# ***DEAR/VIP apparatus (transformed in a large flat X-ray camera)***

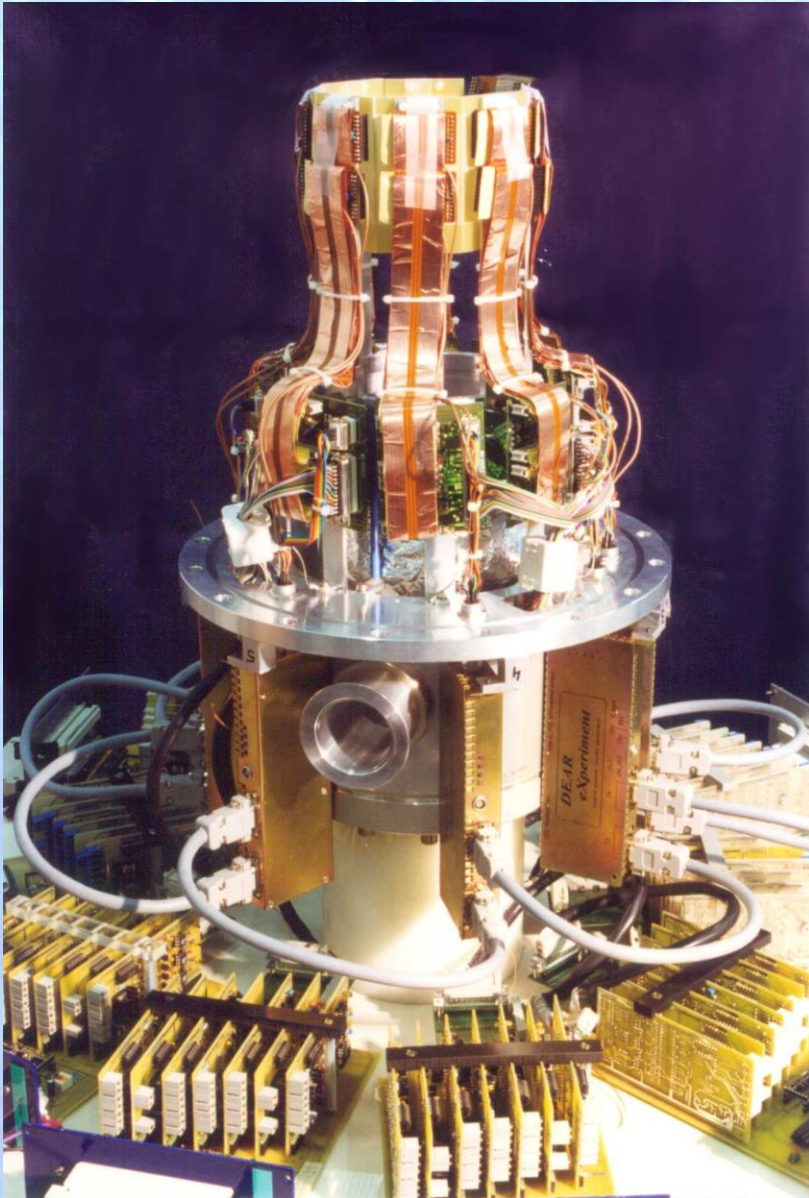

**16 CCD-55-30 deeply depleted (Marconi)**

**pixel size of  $22.5 \times 22.5 \mu\text{m}$**

**depletion depth of  $30 \mu\text{m}$**

**effective area of  $7.3 \text{ cm}^2$**

**1430784 pixels each  
(21.8 Mpixel,  $116.8 \text{ cm}^2$ )**

**Vacuum & cryogenics for  $-120\text{C}$  operation**

**Transport drivers**

**High precision spectroscopic amplifier**

**Software dual slope integrator**

**Fast DAQ (250-600 MB/s RT)**

**Noise reduction & charge transport  
correction algorithms implemented**



## Structure Probing by Holographic Imaging at Nanometer scale with X-ray lasers (SPHINX)

SPHINX aims producing an X-ray phase-contrast holography system for femtosecond imaging microscopic samples and their internal parts with nanometer resolution, using a combination of polycapillary lenses, large X-Ray CCD arrays and XFEL sources. The proposed configuration allows beam splitting, focusing, magnification and refractive diffraction in the keV range.

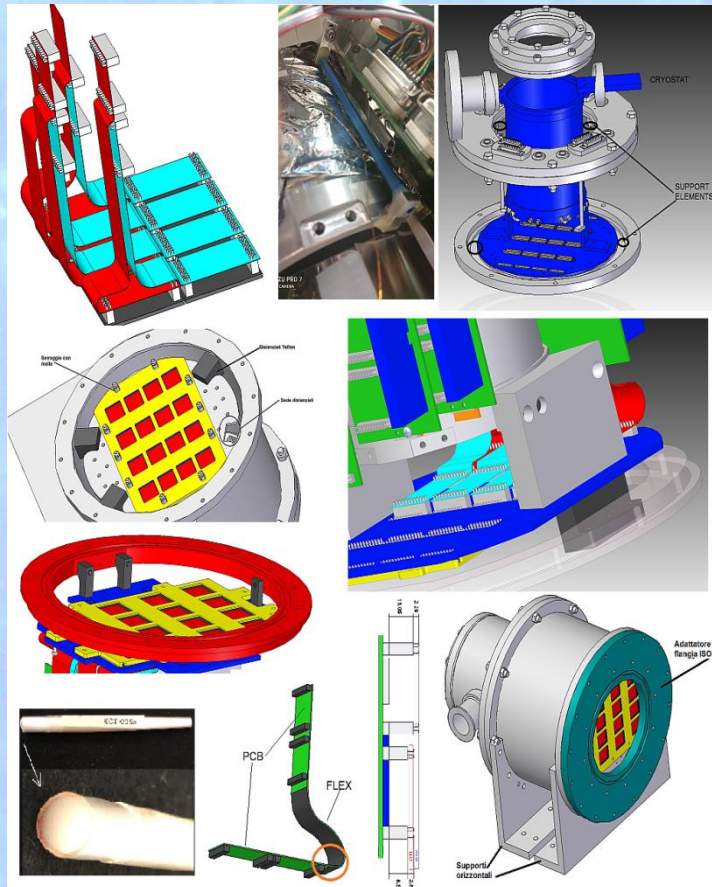

### Current prototype status:

1. Full design (mechanics, cryogenics and electronics) finalized; production completed, delivered.
2. First X-ray optics delivered, synchrotron tests in preparation.
3. DAQ and slow control software completed.
4. MC code in advanced phase; reconstruction program work initiated
5. Calibration systems under development

## Structure Probing by Holographic Imaging at Nanometer scale with X-ray lasers (SPHINX)

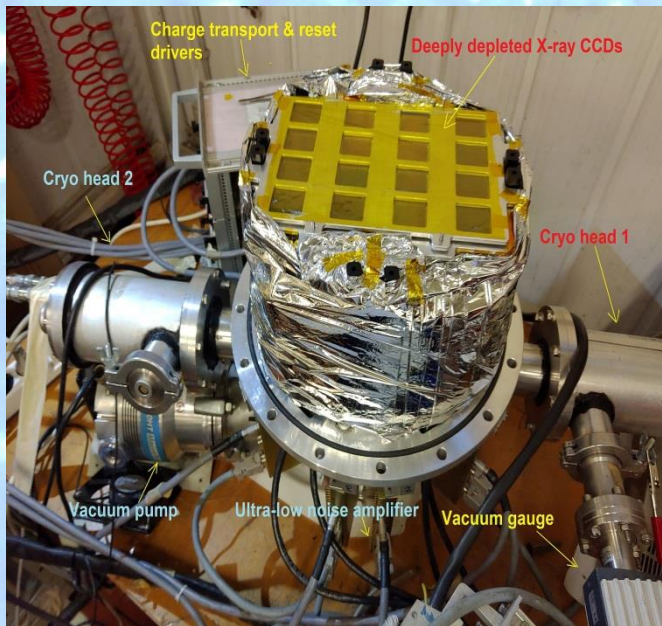

**Current prototype status:**

**6. Full detector assembly completed.**

**7. Vacuum and cryogenic testing completed.**

**8. Optics bench design completed, all components realized, ordered actuators arrived, second vacuum chamber and feedthrough flanges realized.**

**The bench parameters are:**

**-10 degrees of freedom (8 translations, 2 rotations)**

**-50 nanometer average precision**

**-25 nm precision with position feedback for the sample stage.**

**-installation in advanced phase.**

**9. Measurement plan with DIAMOND synchrotron**

**10. Contact with European X-FEL established, more specific plans to follow the optics investigation.**

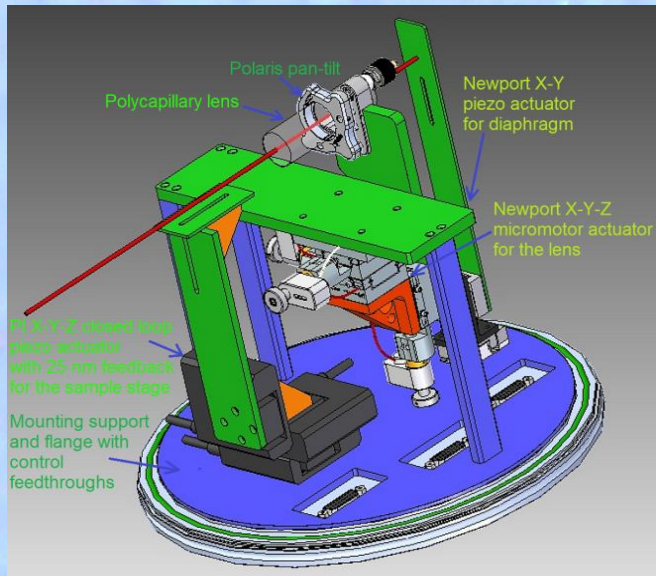

# Working plan for 2024

## Completion of the prototype setup:

- upgrading the CCD charge transport drivers (2002, untraceable components )
- mechanical pixel alignment sistem ( $\sim\mu\text{m}$  precision grid, actuators)
- optical bench calibration system (laser+diffraction pattern generator)
- vacuum setup adapters for the synchrotron line

## Testing the basic functioning of the apparatus at LNF

## Developing a full MC simulation code (possible completion within 2023)

## **Experimental proof of concept** on the coherent synchrotron beamline at DIAMOND using the SPHINX prototype:

- testing the polycapillary optics and designing the beam interface with the setup
- installing the needed instrumentation and testing the full functionality
- sample measurement campaign and holographic reconstruction with moderate resolution (given the synchrotron and the setup limitations)

# Available resources and needed support

## Available:

Prototype setup (presented above) in very advanced phase of completion, equipped with a large X-ray CCD detector array, a highly tunable optical bench with 10 DOF nm-precision , X-ray polycapillary dedicated optics, data acquisition system, slow control, vacuum system and cryogenics.

## FTE 2024 (preliminary):

M. Iliescu (30% resp. locale), M.Bazzi (20%), L. De Paolis (50%), A. Clozza (20%), A. Khreptak (50%). **Total 2.0 FTE**

## Requests:

**CSN5 2024:** 15k electronic drivers and cabling, 3k actuators for grids, 4k mechanics for calibration, 5k optical calibration system, 4k vacuum components for synchrotron coupling, 12 k missions to DIAMOND **Total: 43 k**

**LNF Services 2024:** 0.5 mu SPCM for realizing and installing small mechanical items needed for interfacing the new calibration systems to the current setup.

# Final XRH-FEL setup proposed layout

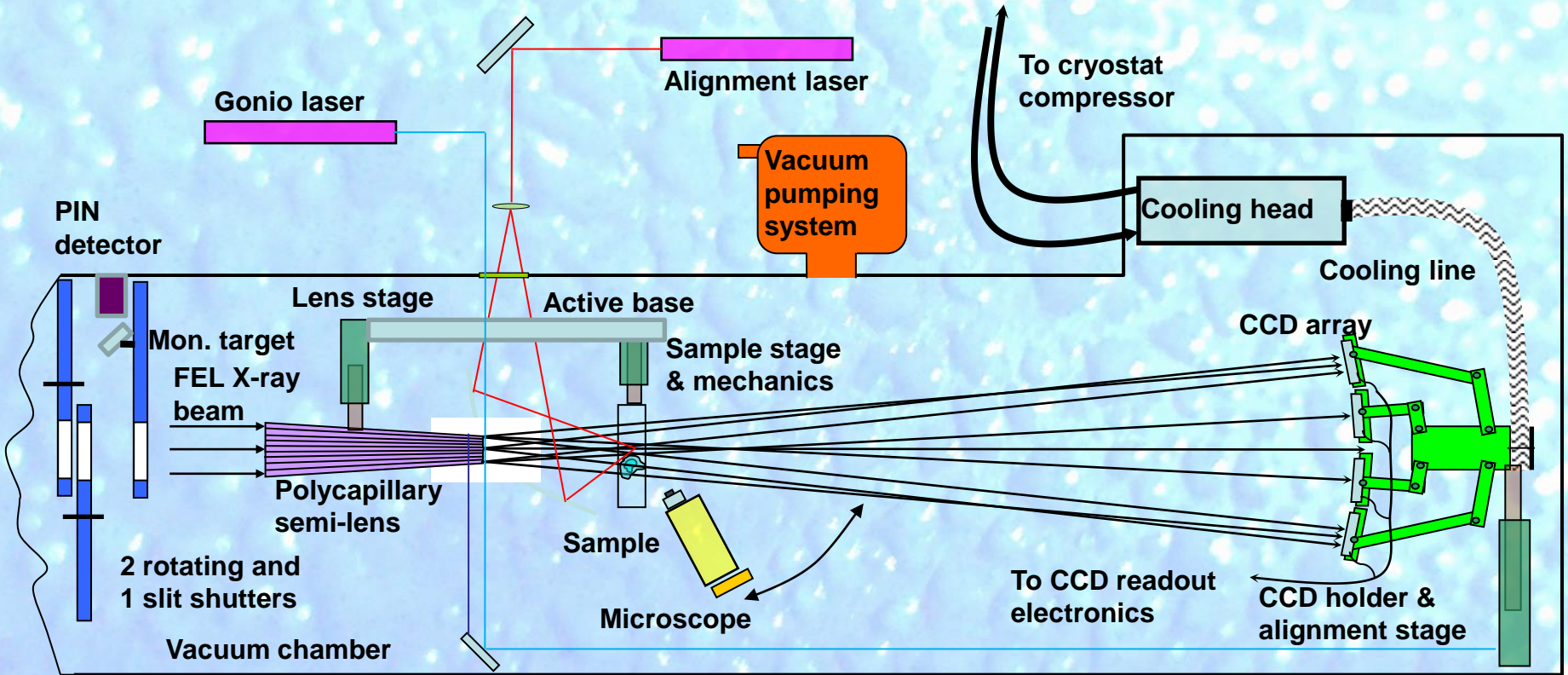

The final project aims realizing a soft X-ray holography apparatus for phase contrast imaging, based on a large area CCD array and new X-ray optics, to be used on the recently available XFELs. The XFEL beam will grant three of the critical parameters, namely the **coherence**, the **ultra-short exposure** and the **requested flux**. The large area deeply depleted CCD array will ensure the **full coverage of the useful solid angle**, while the **concentrated (over few  $\mu\text{m}$ ) X-ray source** will be created using **polycapillary optics**, on which many studies demonstrated a high degree of coherent propagation. The reference beam consists in the fraction of rays not crossing the sample, overlapping the last's one shadow over the whole detector area, **geometry uniquely allowed by capillary half-lenses**.

## ***Closing notes***

- The resolution targeted by the proposed method represents a breakthrough in the field, bringing the holography application in the **few nm range**, where **in-vivo** individual cell elements (DNA, organelles, etc.), viruses, antibodies and proteins can be directly 3-D visualized.
- The method might have applications in **nanorobotics**, too, where in-action visualization is still an issue.
- The ultra-short exposure (tens of fs) allows reconstruction of sample configuration during **fast molecular interactions**, yet unexplored by imaging techniques.

# Comments

A common question about the coherent source: after the propagation inside capillaries, the photon paths will be different one from the other, so transforming the initial "flat" wavefront in a very complex one. Will this worsen the reconstruction? The answer from ptychography results is: no, the complex wavefront, if properly known (scanned), will offer a better reconstruction reference than the lab system, unstable at nm level. Some bibliography demonstrating the idea is cited below (much wider is available):

Coherent propagation in capillaries investigated in [1, 2, 3, 4]

Ptychographic phase mapping and reconstruction methods validated in [5, 6]

Coherent holographic reconstruction up to 12 KeV with single, tapered and bent glass capillary waveguides was treated in [2].

1. *S.B. Dabagov, H. Uberall, NIM B 266 (2008)*
2. *C.Fuhse, PhD Thesis Gottingen Univ. (2006)*
3. *A. M. Zysk et. al, Optics Express V. 20, No. 4, 3975*
4. *S.B. Dabagov et. al, Appl. Optics, V39, N19 (2000)*
5. *Marco S. et. al. Scientific Reports 3 : 1927 (2013 )*
6. *P. Thibault et. al., "High-resolution scanning X-ray diffraction microscopy," Science 321, 379–382 (2008)*

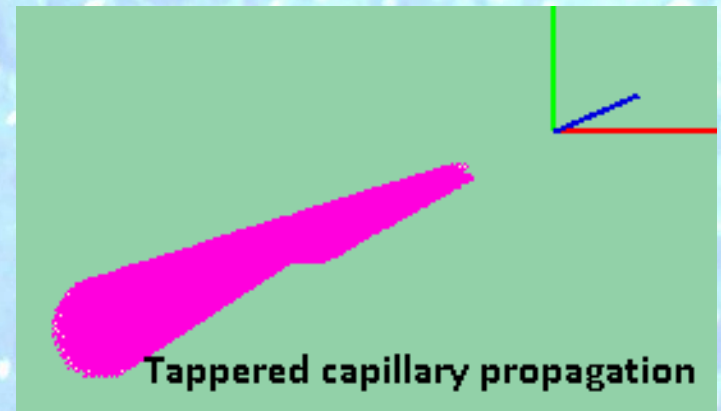

In order to estimate possible outcome, a Monte Carlo development is ongoing:

-to properly reconstruct the phase map at the lens output, 740 billion photons are propagated trough each fiber with a path computed in double precision

-a parallel algorithm (OMP based), able to efficiently distribute the threads on as many cores as available was developed

-the run-time is long with the available means; however, a first result for a reduced set of capillaries is expected to be available soon