Online Track Reconstruction and Calibration for the Mu3e Experiment

Haris Murugan

Supervisor: Prof. Dr. Niklaus Berger

“Monthly Review Meeting of Intense”

2nd May, 2023

Institute of Nuclear Physics,
Johannes Gutenberg-Universität Mainz



H2020 MSCA ITN
G.A. 858199

Mu3e Experiment

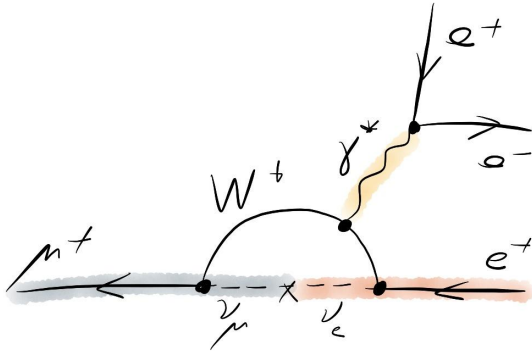

- We aim to observe or exclude the decay of a positive muon to two positrons and an electron.
- In standard model, possible via neutrino mixing but suppressed to unobservable level ($\text{Br} < 10^{-54}$).
- Observation would be a violation of the lepton flavour conservation.
- SINDRUM limit the sensitivity to $\text{Br} < 10^{-12}$ (1988) PSI.
- Phase I - muon rate of $1 \times 10^8 \text{ s}^{-1}$ and $\text{Br} < 2 \times 10^{-15}$.

Mu3e Detector

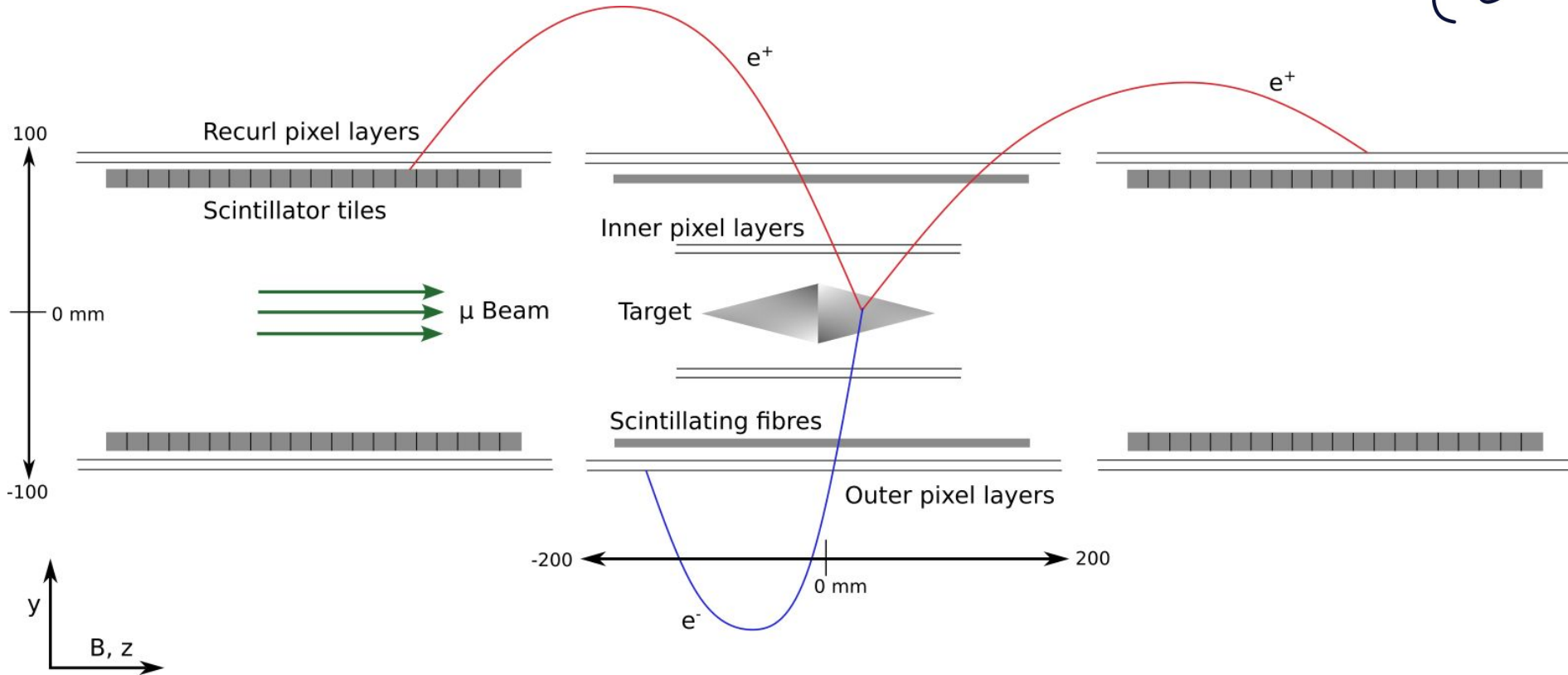

Detector Subsystems



Tracking detector

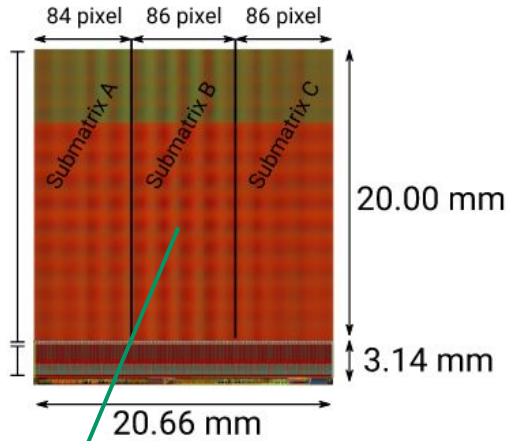

MUPIX: High Voltage Active Pixel Sensors, pixels and the detector electronics are integrated into the same chip

Timing detector

Scintillation fiber:
timing resolution is ~ 1 ns

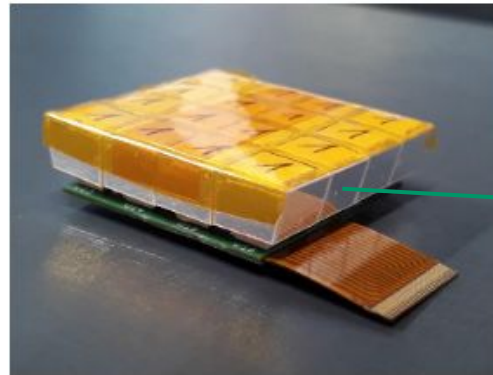

Scintillation Tiles: timing resolution about 70 ps



Signal and Background processes

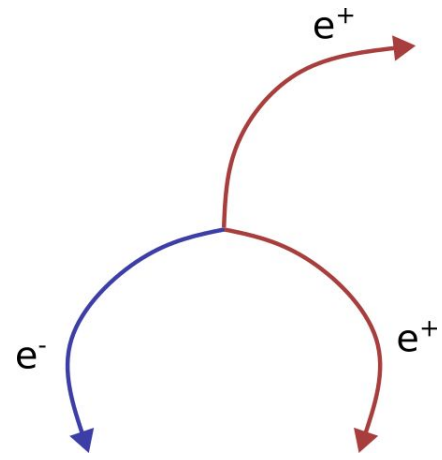

Signal

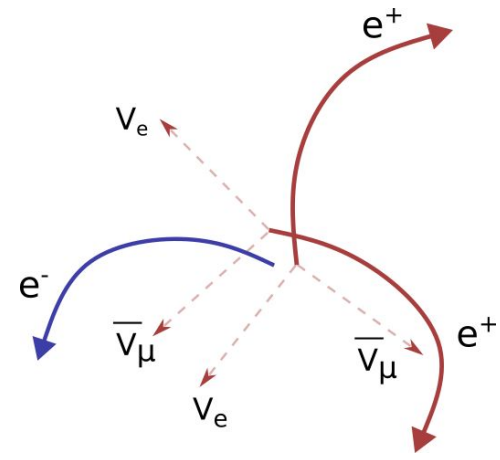

Combinatorial Background

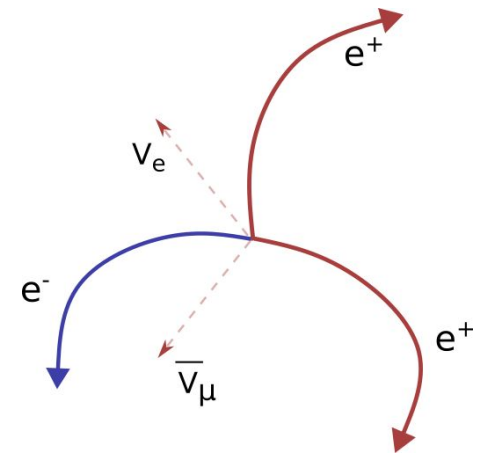

Internal photon conversion
(Br = 3.4×10^{-5})

Readout System

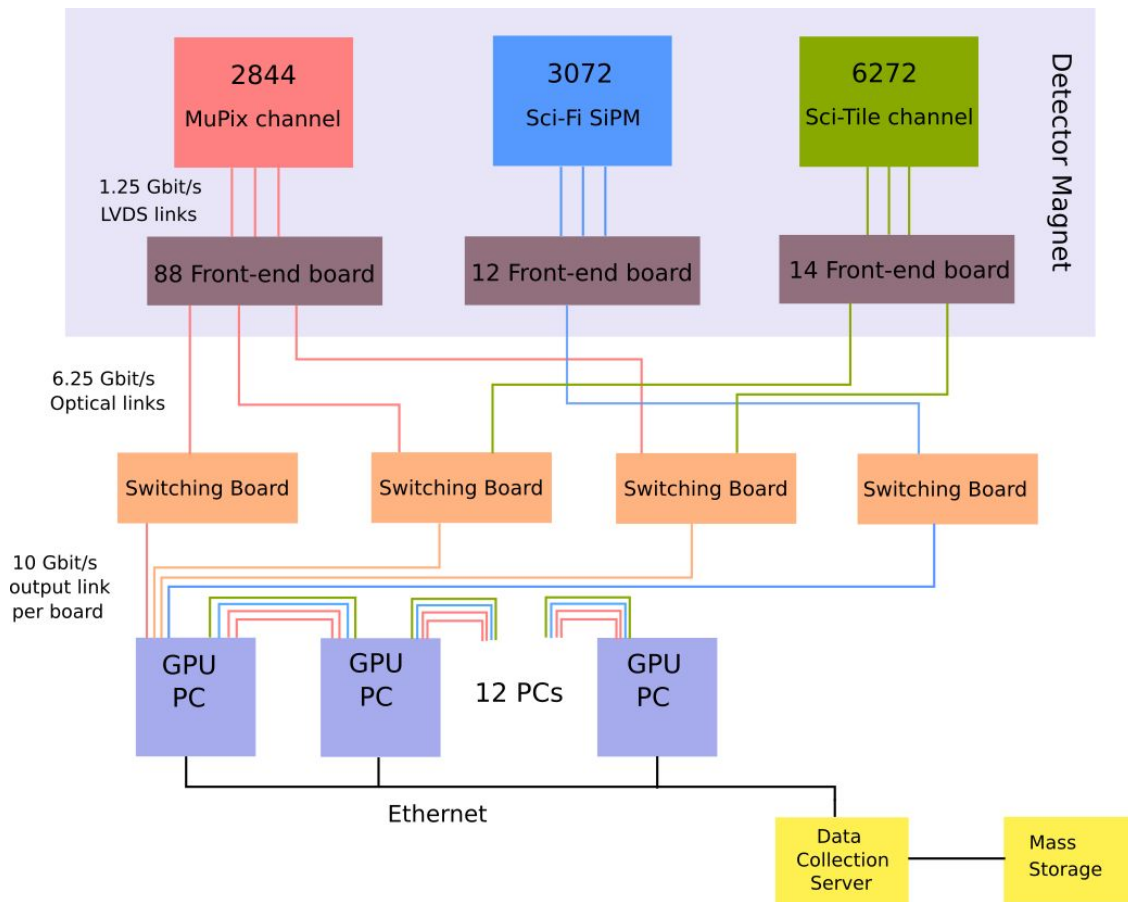

Detector	Rate (Gbit/s)
Pixel sensors	56
Fibers	28
Tiles	17
Total	101

Filter Farm

- Objective - select signal candidate events by reconstruction of tracks and vertices. To reduce data rate by a factor of 100.

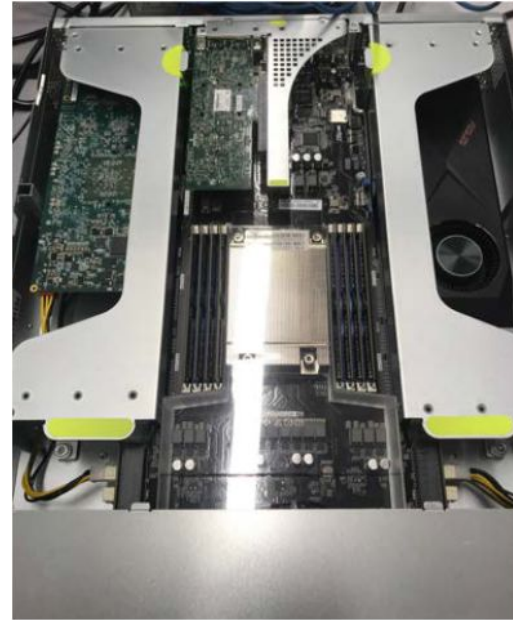
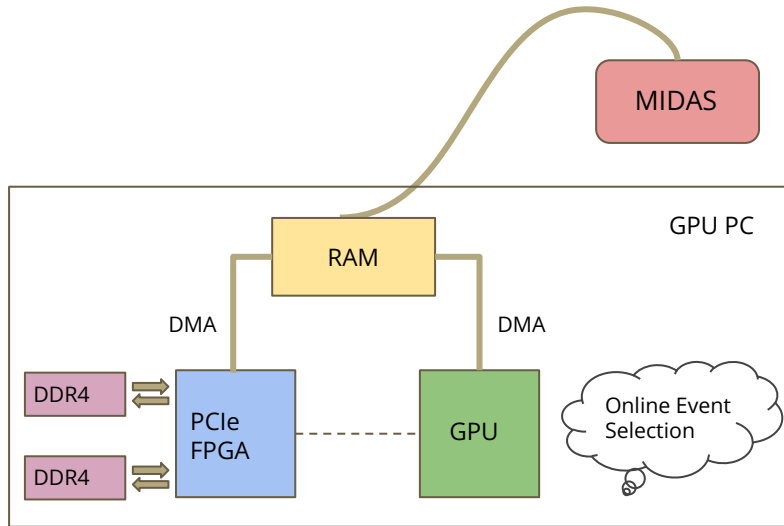

- NVIDIA GeForce RTX 3080 Ti.
- DE5a-NET FPGA card by Terasic.





Global memory layout

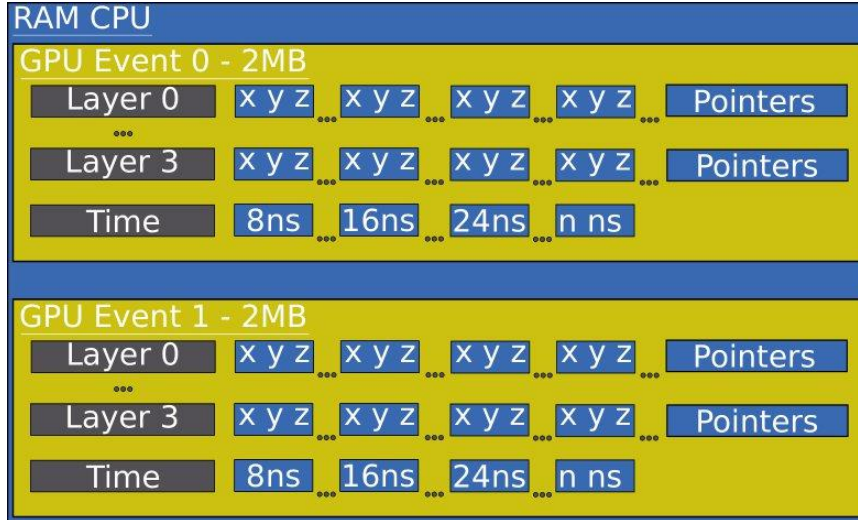



Frames - Time Slices

- Each frame is a snapshot of 64ns.
- Threshold performance - 1.5625×10^7 frames per second.

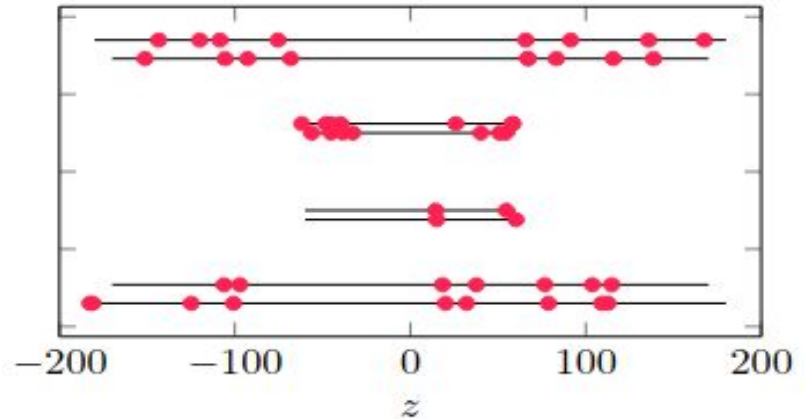
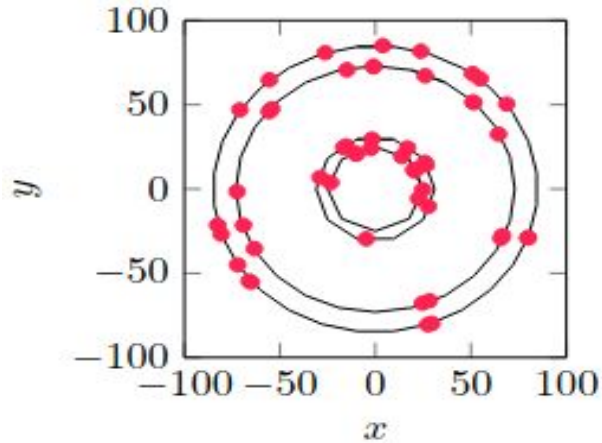

Online Event Selection

- Selection Cuts: Geometric cuts.
- Track Reconstruction: Hit triplet-based reconstruction.
- Vertex Selection: Reconstruction of possible event vertices.

Track Reconstruction



- 3D Multiple Scattering (MS) fit.
- Finds the curvature, minimising the MS angles for each triplet.
- Fits the triplets from first 3 layers after preselection.
- Helix trajectory is propagated to the 4th layer and the closest hit is found.
- The global curvature from both helix is used find the track parameters.

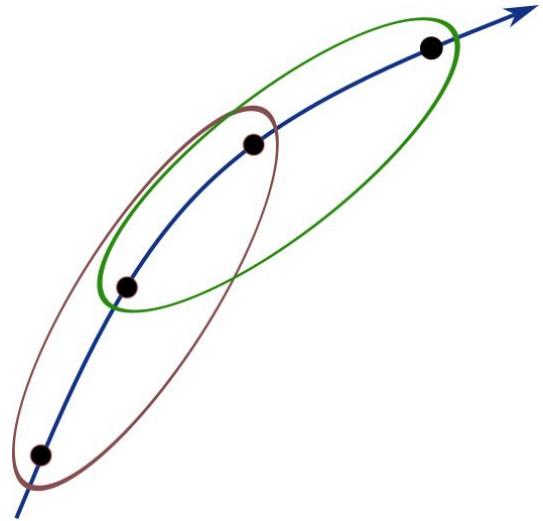

Online Histograms

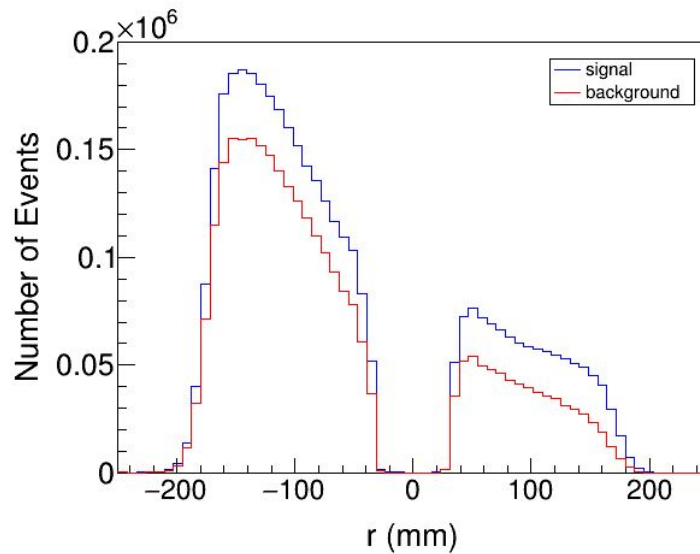
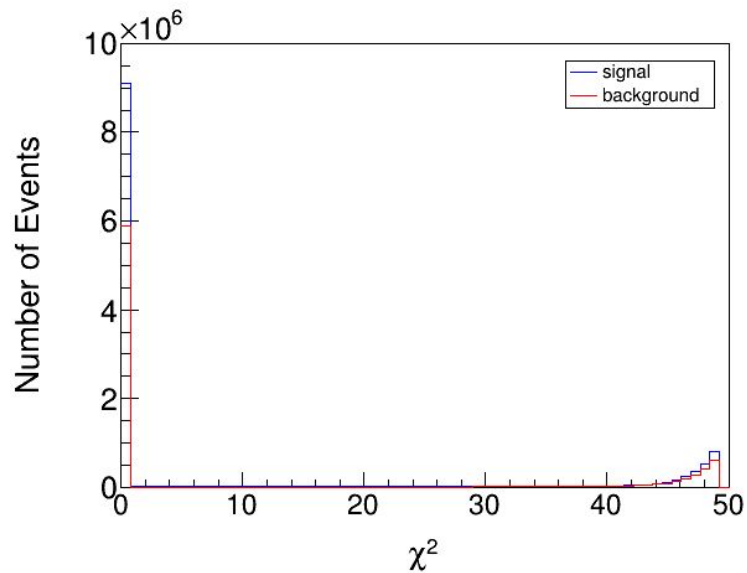

Vertex Selection

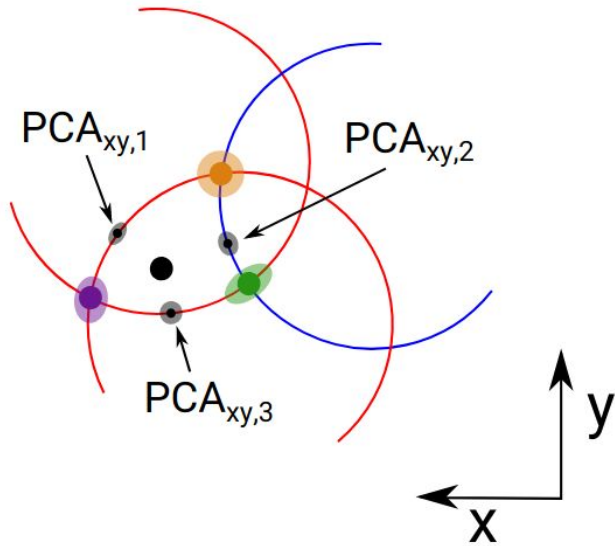

- With curvature the e^- and e^+ can be identified.
- Only when all three tracks intersect in the transverse plane then the weights are calculated.
- The weights are from the MS in the first detector plane and due to the pixel size.
- The total energy of all particles, must match the muons rest mass and total momentum is zero.
- Time slices with signal vertices are kept.

Online Histograms

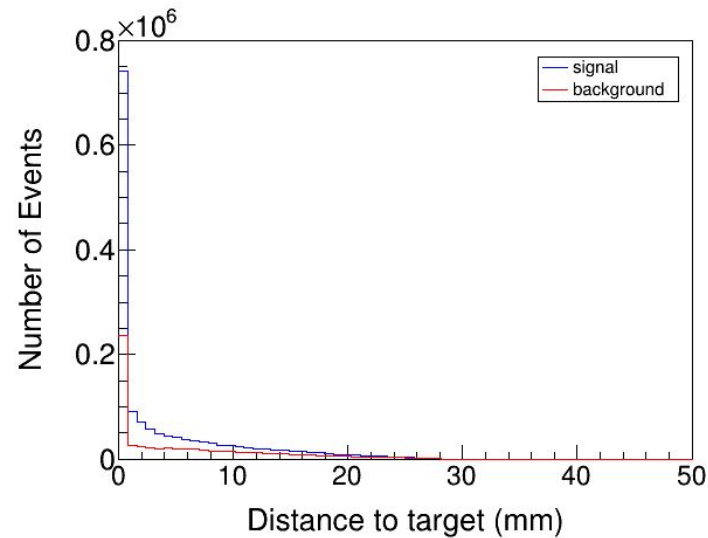
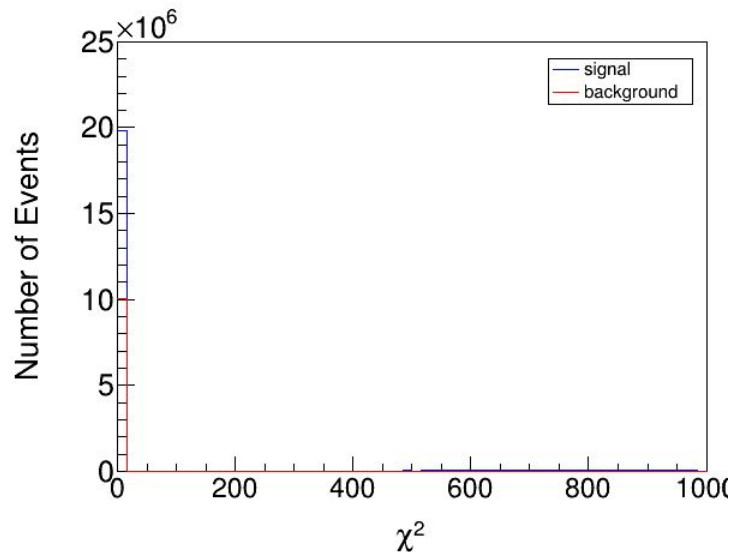

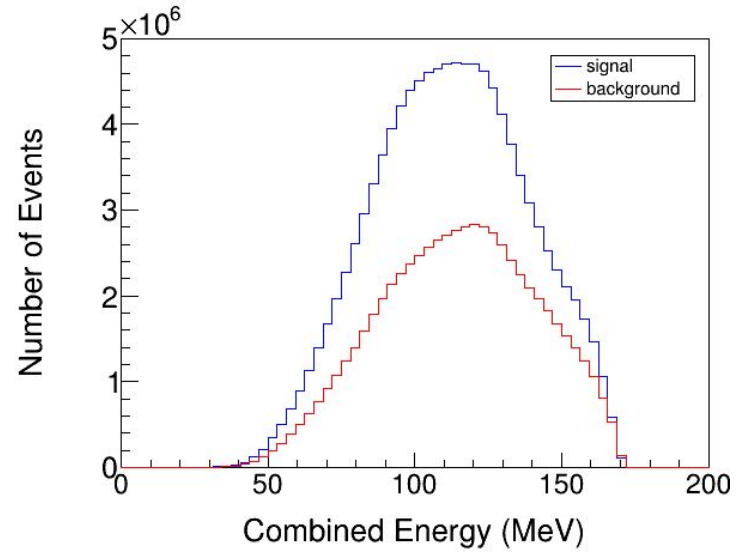
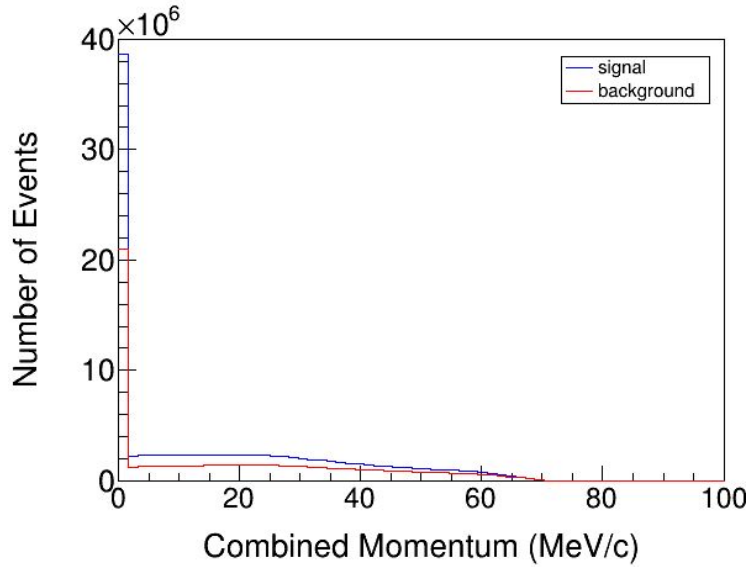

Parallel computing on GPU

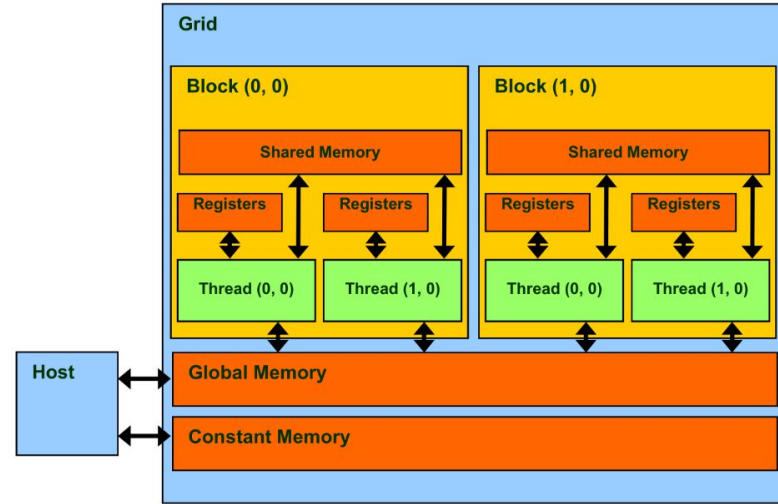

- Each SM consists of 64 CUDA cores in 2080Ti and 128 CUDA cores in 3080Ti.

- Warps of 32 threads execute at once in streaming multiprocessors (SM)

Performance

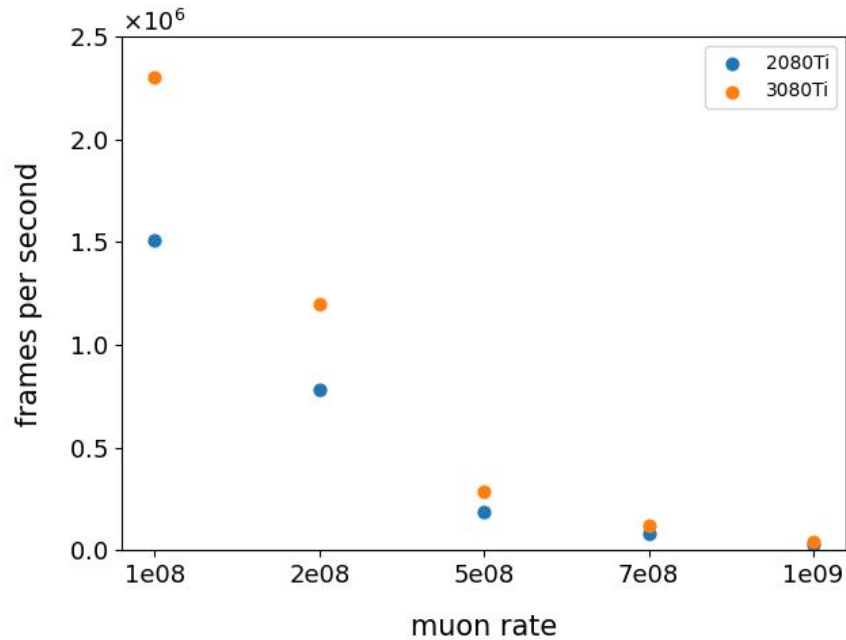
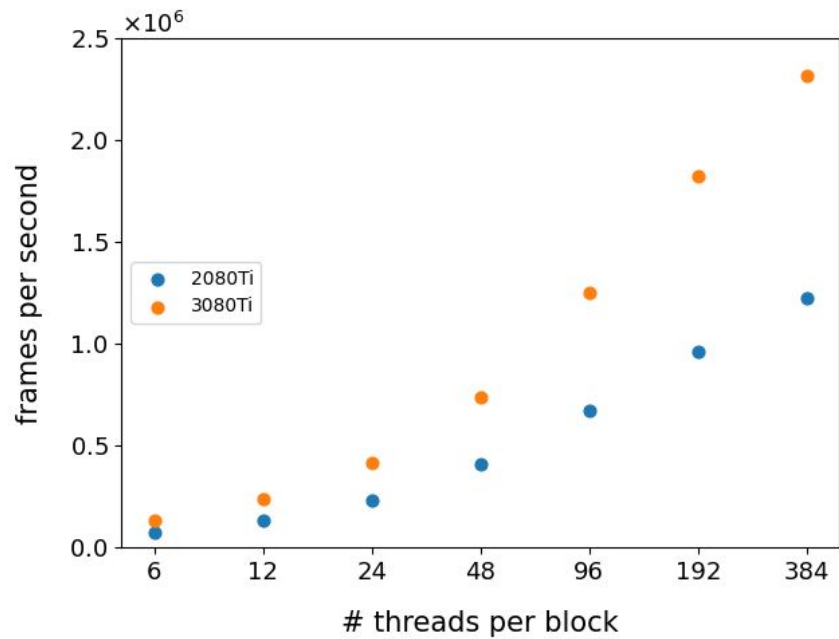

Efficiency

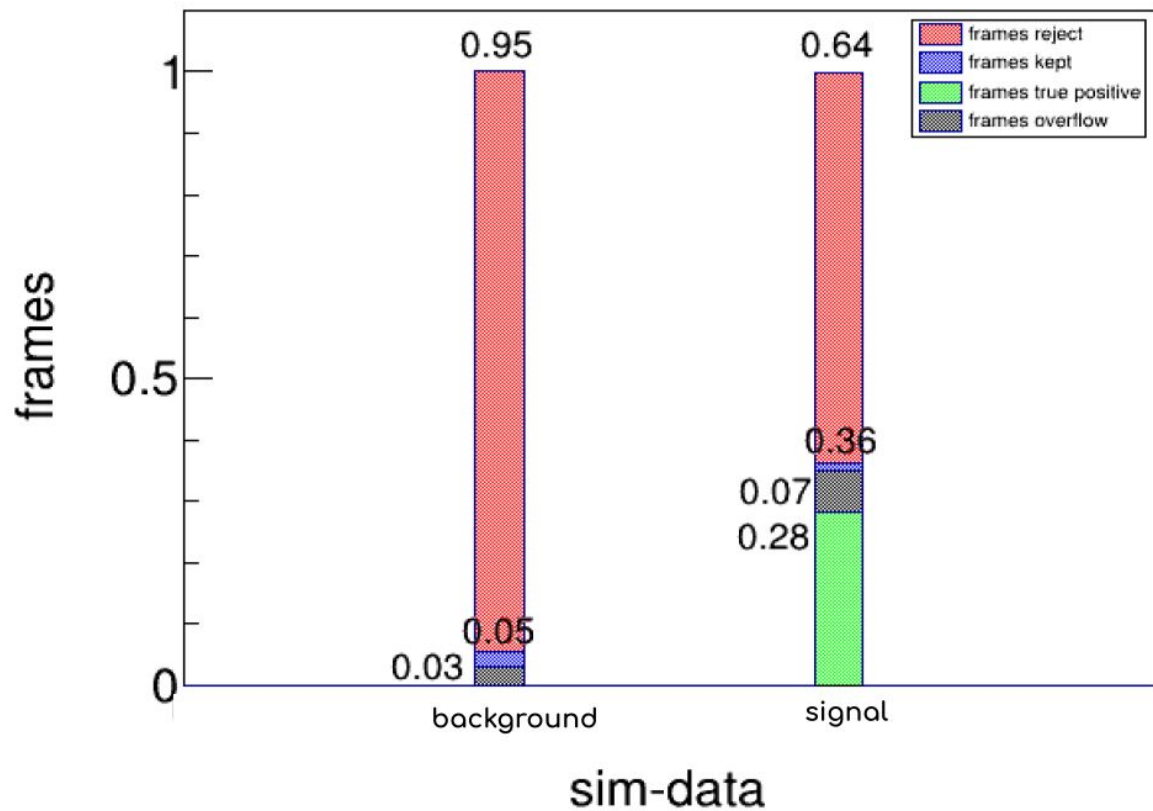

Camera System for Calibration

Track-based Alignment



$$r_{ij} = m_{ij} - f(\mathbf{q}_j, \mathbf{p})$$

$$\chi^2(\mathbf{q}_j, \mathbf{p}) = \sum_j^{\text{tracks}} \sum_i^{\text{hits}} \left(\frac{r_{ij}}{\sigma_{ij}} \right)^2$$

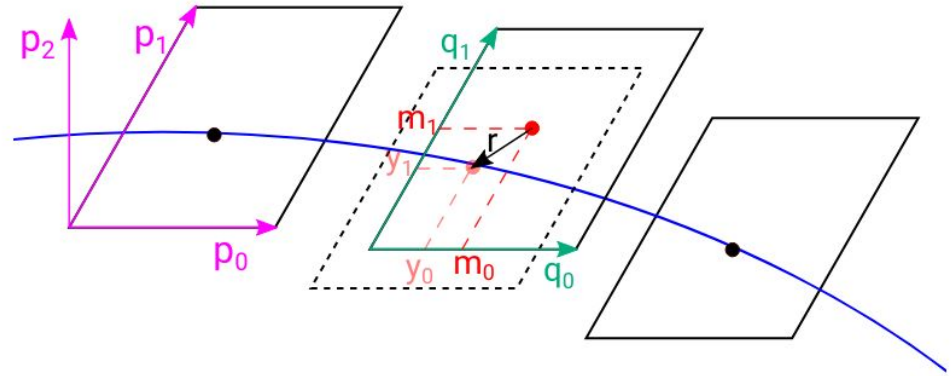

- We get residuals after fitting individual particle tracks with an adequate track model.
- From these residuals, one can derive geometry corrections.
- These track fits however assume a fixed set of global parameters. As a result, the obtained residuals will be biased in case of shifts in global parameters.

Weak Modes

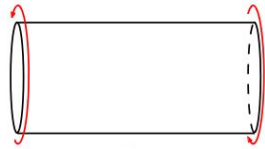

(A) Torsion

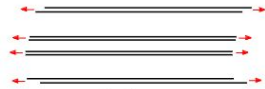

(C) Shearing

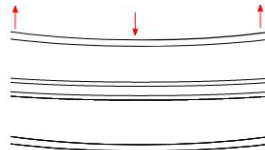

(E) Bowing

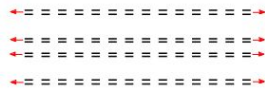

(G) Stretching

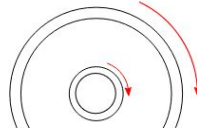

(B) Curling

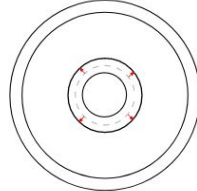

(D) Radial

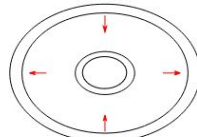

(F) Elliptical

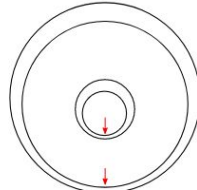

(H) Sagitta

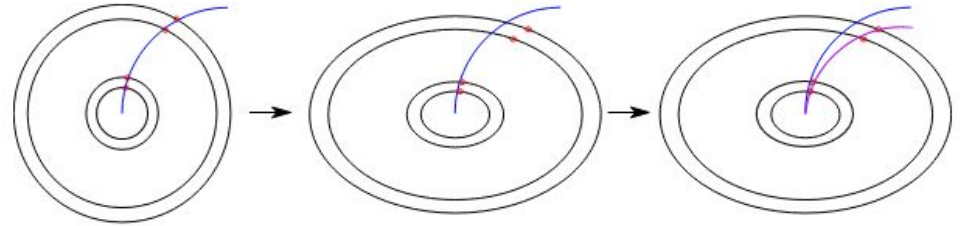

- In blue, the true track is depicted.
- If the barrel is deformed elliptically, the blue track will have a worse χ^2 than without the deformation.
- Purple track can be reconstructed with the same χ^2 as the original blue one.

Misalignment

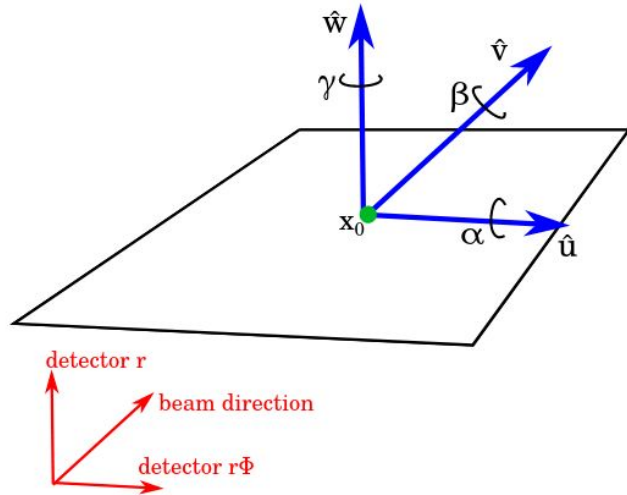

$\sigma_{\text{off, u,v}}$ (mm)	$\sigma_{\text{rot, } \alpha, \beta}$ (mm)	$\sigma_{\text{off, w}}$ (mm)	$\sigma_{\text{rot, } \gamma}$ (mm)
0.05 (0.45)	5 (10)	0.005 (0.1)	5 (10)

- Deviations of more than 400 μm corresponding to 5 times the pixel pitch (pixel-size) are expected.

Online Efficiency

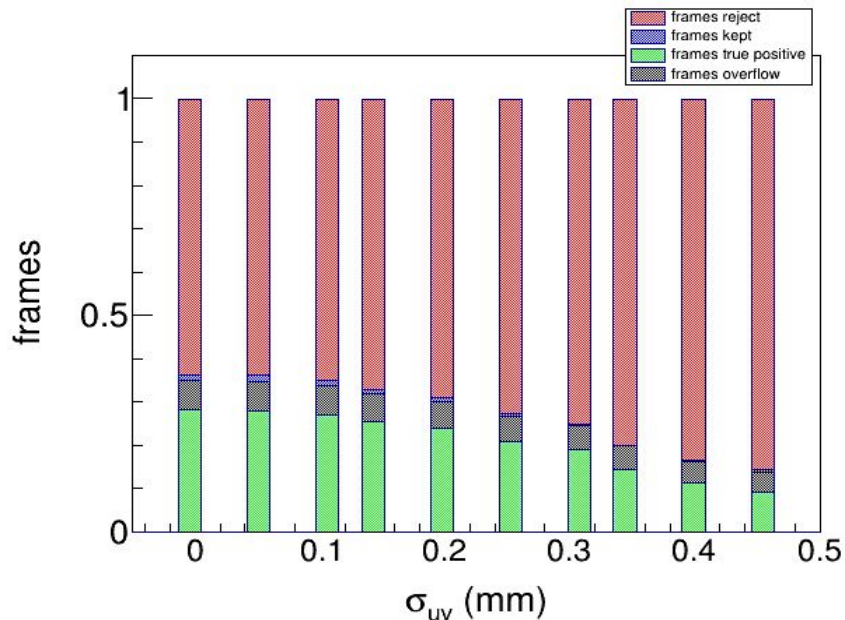
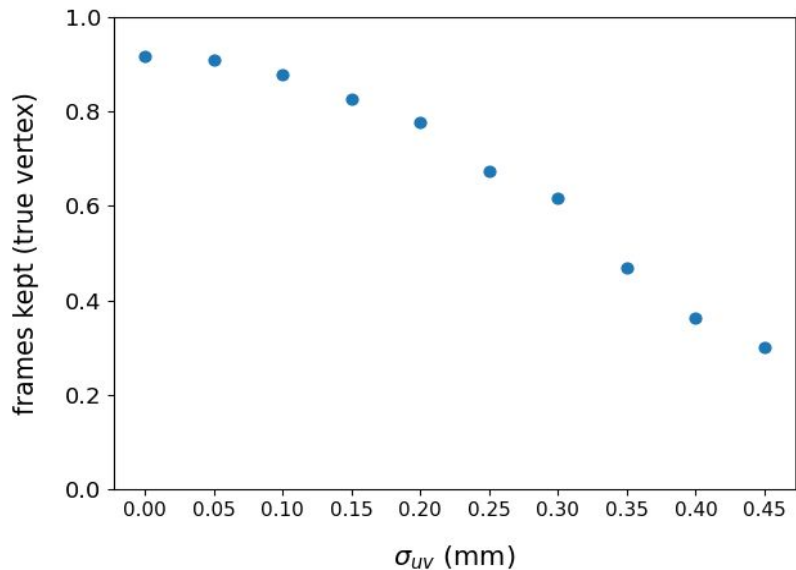

- $\sigma_{\text{off,w}} = 0.1$ mm and $\sigma_{\text{rot},\alpha,\beta,\gamma} = 10$ mRad were applied in all steps.
- Efficiency of Online Event Selection is compared with Monte Carlo truths.

Camera System

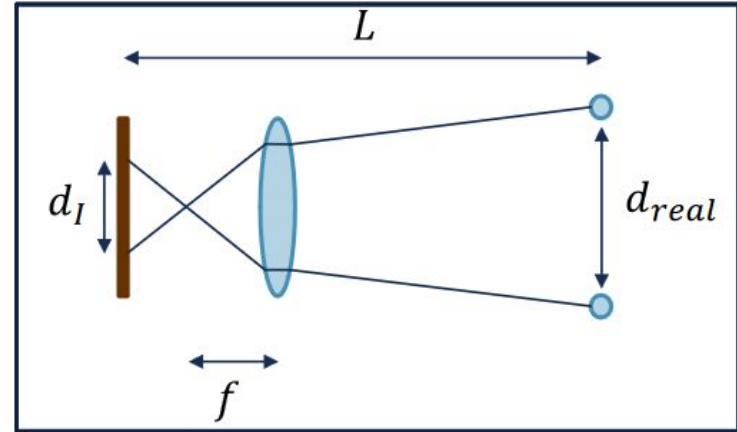
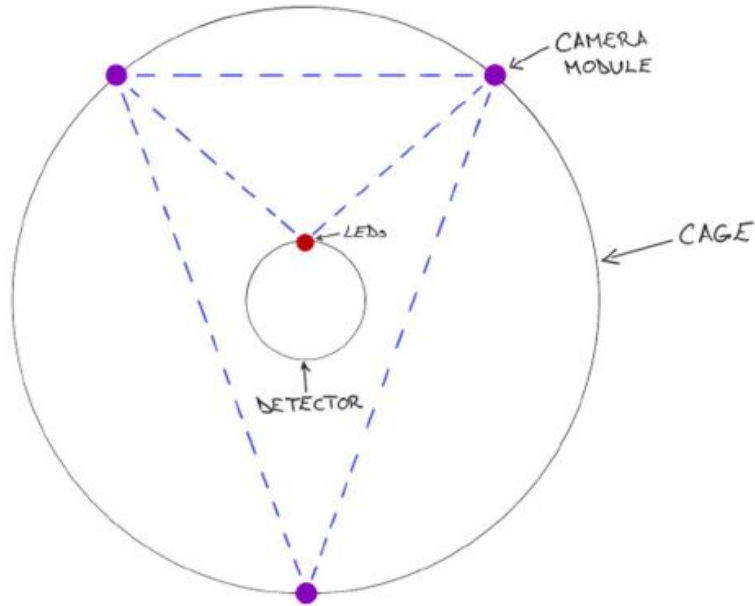

$$\frac{d_I}{d_{real}} = M = \frac{f}{f - L}$$

Lab setup



Main Camera

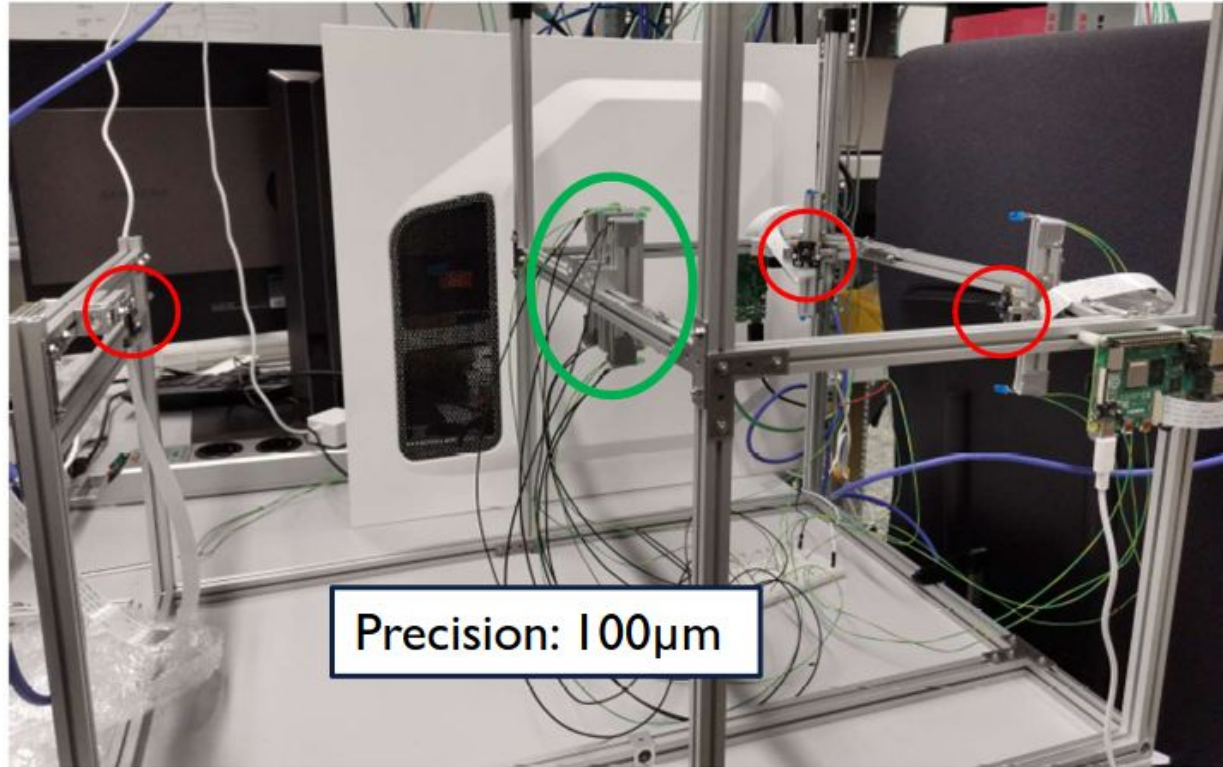

2 cameras with
LED's

LED's on the
detector

Precision: 100 μ m

Updation

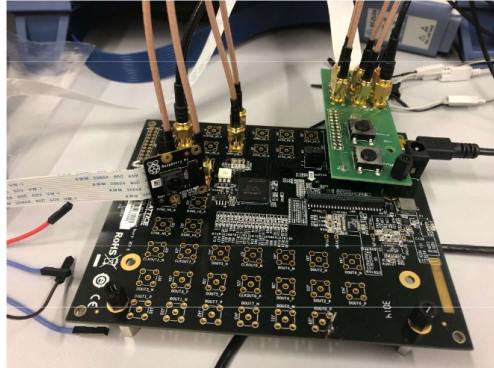
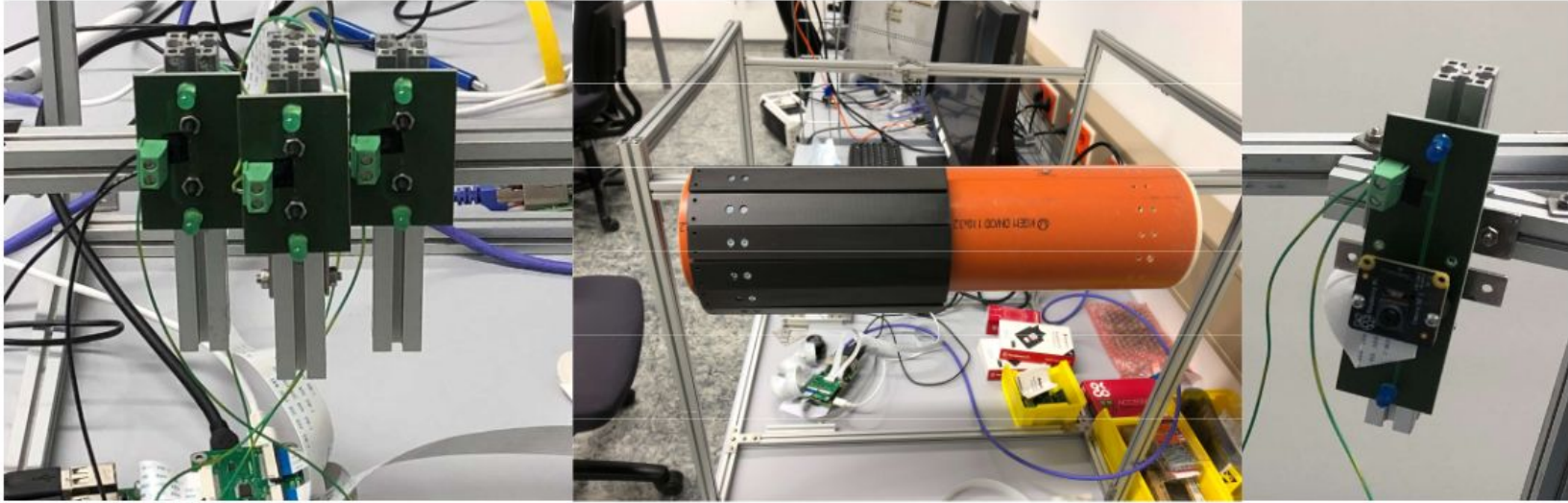

- MachXO3L DSI breakout board.
- Adapter card.

Tooling balls



3 sizes tested

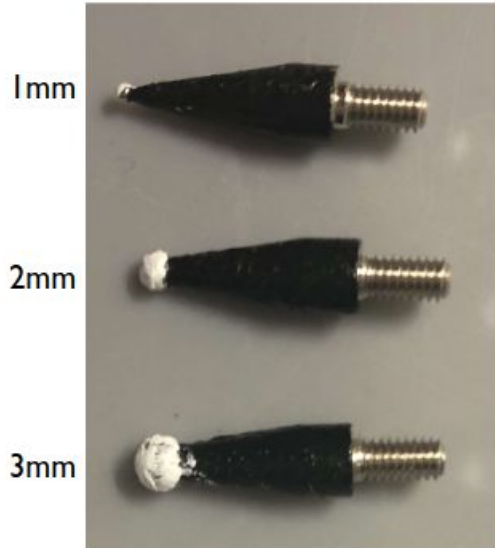

Double reflections due to 2 light sources



Diffuse reflection

Tooling balls



3 sizes tested

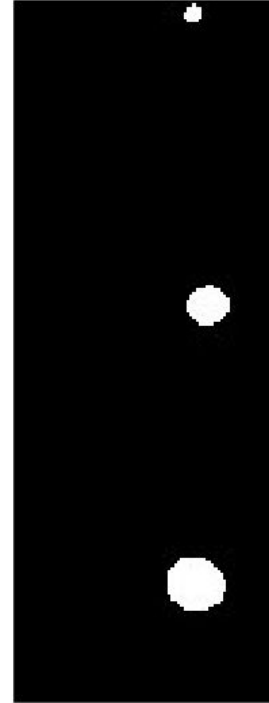
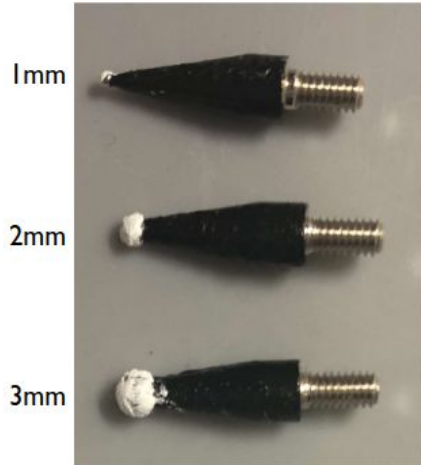

Estimated
distance from
camera:

410.483 mm

Conclusion



- Achieves a peak performance of 2.3×10^6 time slices per sec.
- Therefore, Phase I needs 7 GPU farms with NVIDIA Geforce RTX 3080Ti.
- Extra performance could be used to improve reconstruction efficiency.
- Develop Online Track Alignment for GPU selection.
- Use Camera Calibration inputs for the Online Track Alignment.
- Decision: LEDs or tooling balls or tape

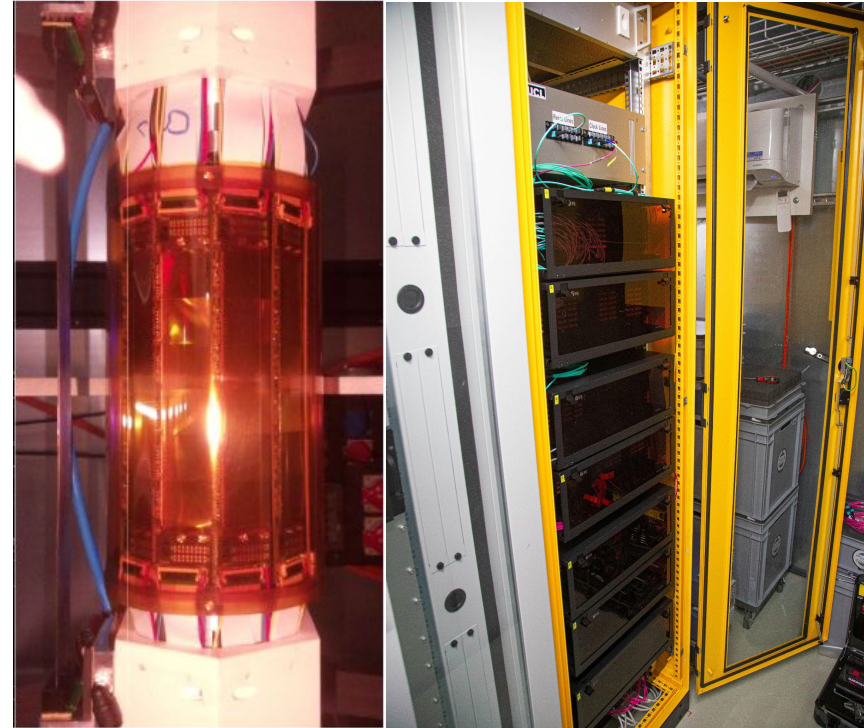

PhD Requirements:

- Took the teaching assistantship of Advanced Practical course on Balmer series for the summer semester, 2023.

Workshops and Conferences

- “Mu3e Collaboration Meeting”, (Villigen, April 28-29, 2022) workshop held at Paul Scherrer Institute;
- “EPT Summer Camp for Physics TAs”, (Zuoz, August 12-14, 2022) engaging physics tutoring summer camp organised by ETH Zürich;
- “Paul Scherrer Institute Particle Physics Summer School – Vision and Precision”, (Zuoz, August 14-20, 2022) lectures and talks organised by Paul Scherrer Institute.
- “PRISMA+ Cluster of Excellence” (Geisenheim, September 19-21, 2022) gave a talk about my dissertation.
- “DPG Conference”, (Dresden, March 20-24, 2023) held and organized by Deutsche Physikalische Gesellschaft e.V.; gave a talk.
- “Mu3e Collaboration Meeting”, (Wengen, March 28-31, 2023) presented works.

Backup

Performance

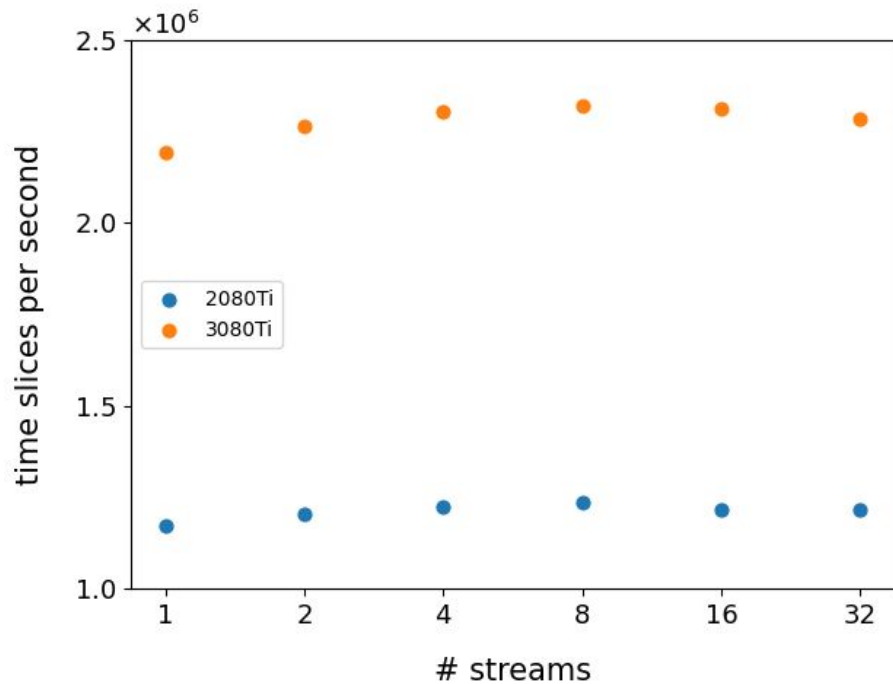
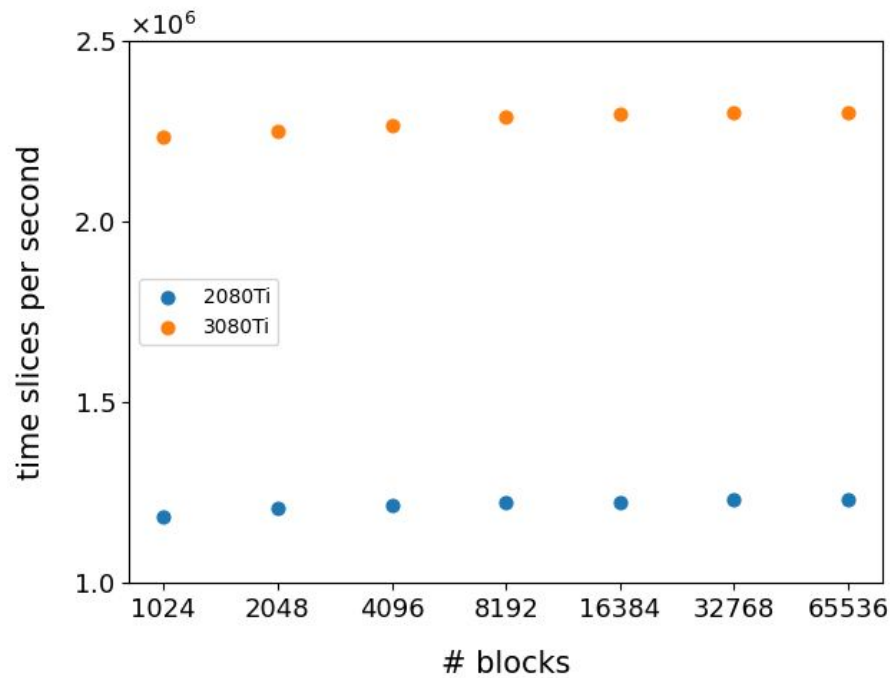

Selection Cuts



- Slope difference $\Delta\lambda$ between the slopes of consecutive layer hits in the longitudinal plane.

$$\tan \lambda_{ij} = \frac{z_j - z_i}{h_{t,j} - h_{t,i}}$$

$$\Delta\lambda = \tan \lambda_{12} - \tan \lambda_{01}$$

- In transverse plane we observe the angle Φ_{ij} between hits of two consecutive layers in relation to the origin:

$$\cos \Phi_{ij} = \frac{\mathbf{h}_{t,i} \cdot \mathbf{h}_{t,j}}{h_{t,i} h_{t,j}}$$

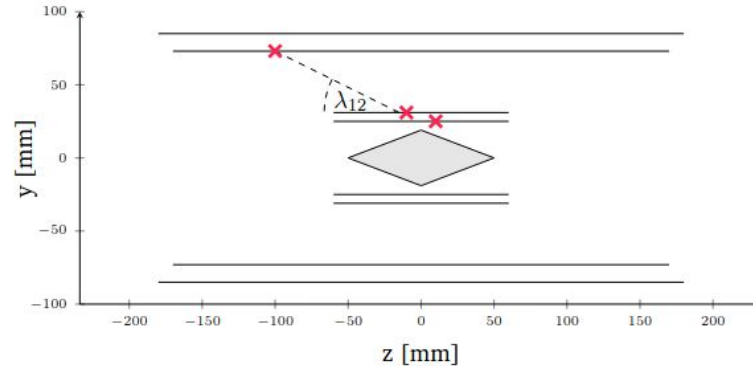

- $z_0 - z_1 < 30$ mm
- The transverse radius of the circle going through all three hits

$$r_{t,c} = \frac{d_{01} d_{12} d_{20}}{2[(\mathbf{h}_0 - \mathbf{h}_1) \times (\mathbf{h}_2 - \mathbf{h}_1)]_z}$$

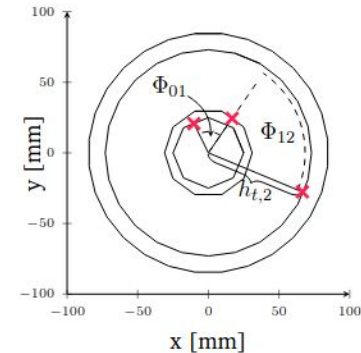

Track Reconstruction



- For reconstruction Triplet fit is used.
- We search for the track minimizing the objective function. Assuming no momentum loss and thus a constant curvature k .

$$\chi^2(\kappa) = \frac{\Phi_{MS}(\kappa)^2}{\sigma_{\Phi}^2} + \frac{\Theta_{MS}(\kappa)^2}{\sigma_{\Theta}^2}.$$

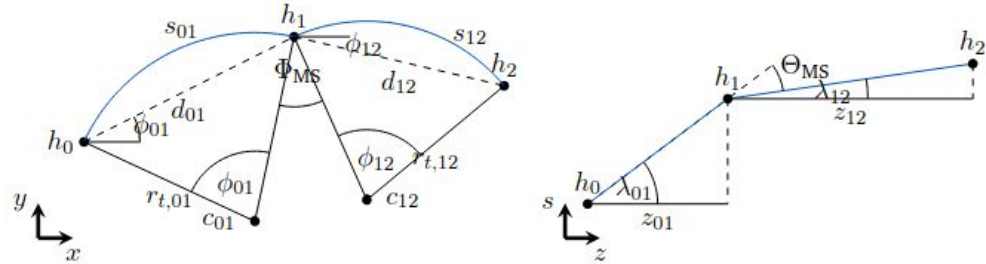

- More than three hits for a full track fit requires to accommodate for multiple triplets.

$$\chi_{\text{global}}^2(\kappa) = \sum_t^{n_{\text{triplets}}} \chi_t^2(\kappa).$$

- A global curvature is found for all triplet combinations minimising the MS angles for each triplet.

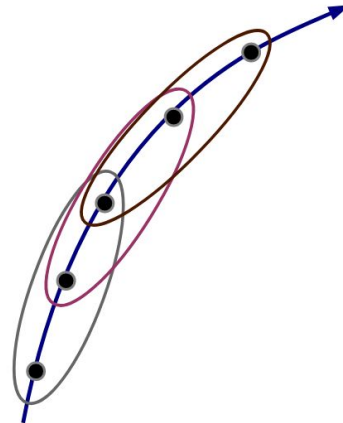

Vertex Fit



- All combinations of two positrons and one electron are considered within each time slice. We calculate the total energy of all particles in the triplet using their curvature κ .
- The total energy of all particles, must match the muons rest energy.
- The weighted mean is calculated only if all three reconstructed tracks intersect and it is calculated for all combinations of three intersections from three tracks.
- The χ^2 for a vertex estimate is computed from the differences between the point of closest approach and the weighted mean both in the transverse plane and in the z-coordinate.

