



30 years in 20'
Angelo

Eryk Piasecki, HIL (Warsaw)

LNS Catania 8.X.2025

How I met Angelo? (My way to LNS Catania)

Institut of Nuclear Research (Świerk): **tripartition (Polar Emission)**

University of Warsaw: experiments in Warsaw, Jyvaskyla, Bordeaux, Saclay, **Ganil (Fission, in particular Coulomb Fission)**

First encounter with Angelo: 1995 (?) in Ganil

In 1997 – meeting in LNS Catania

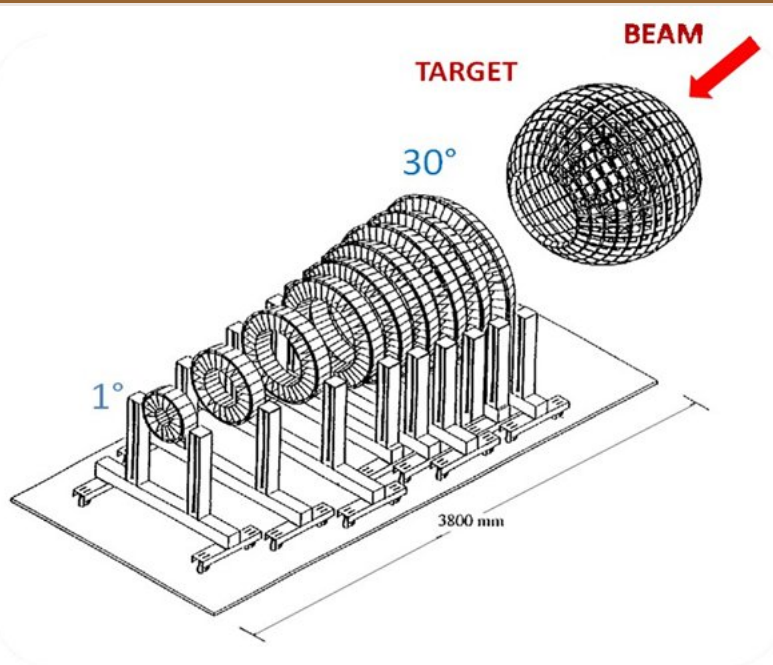

Chimera

~ 4p; 1° – 176°;
1192 telescopes E – DE

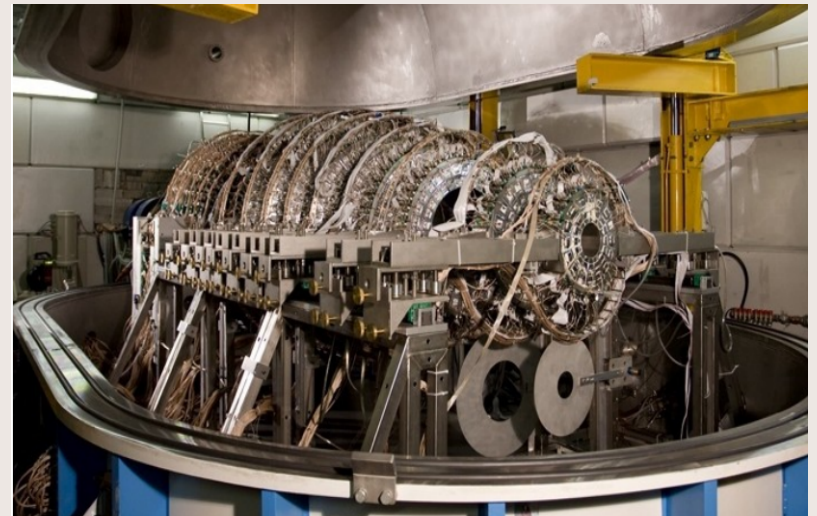
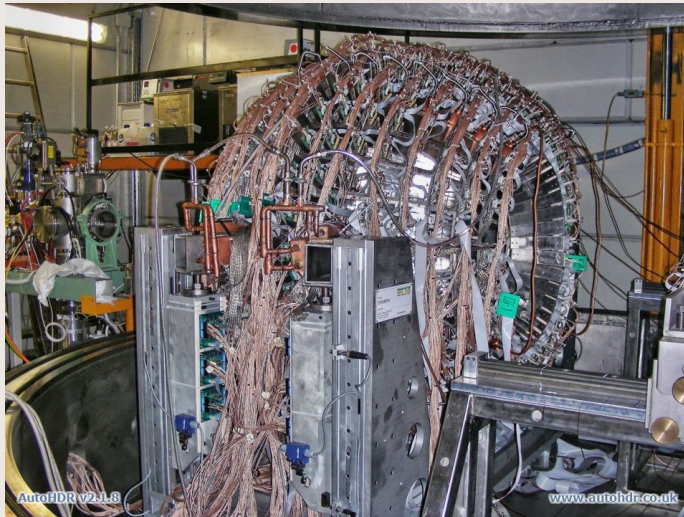

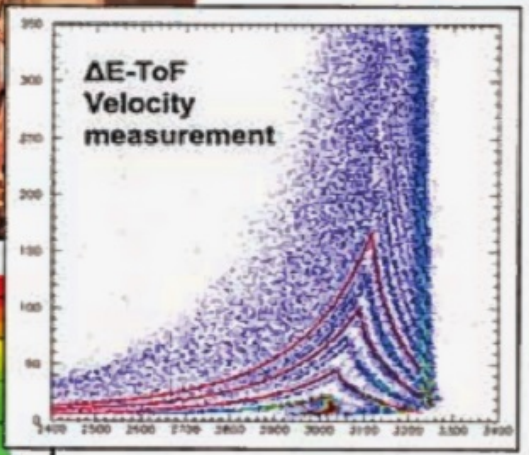
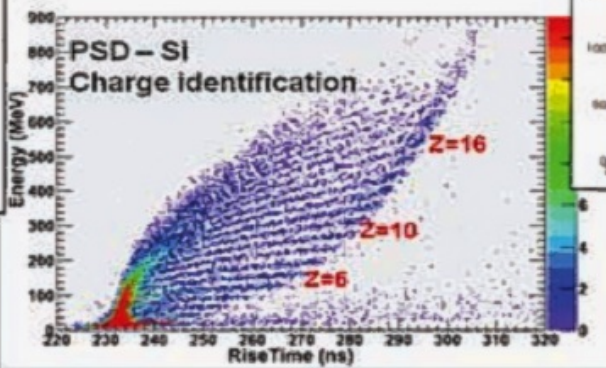
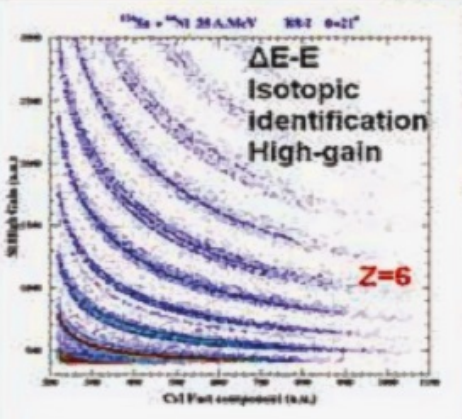
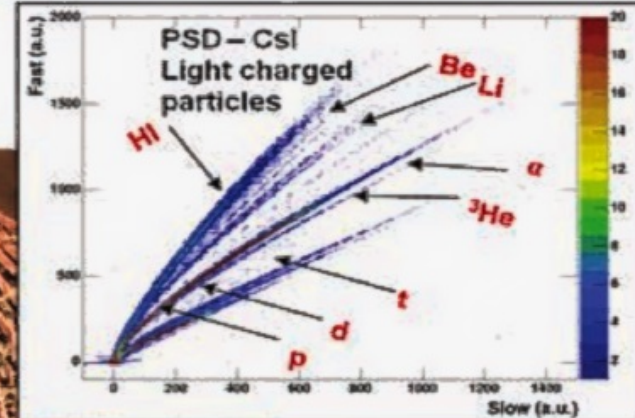
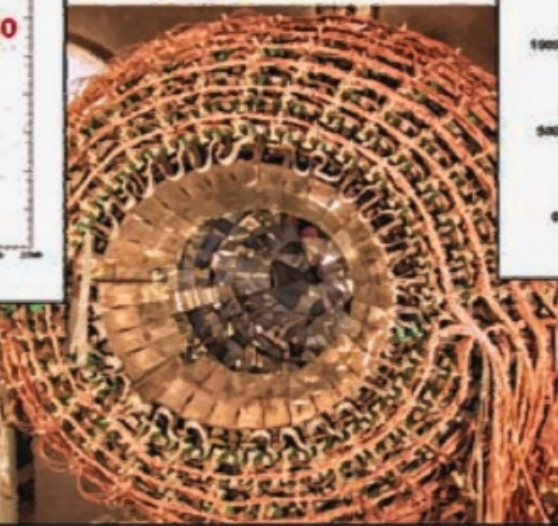
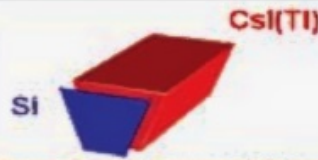
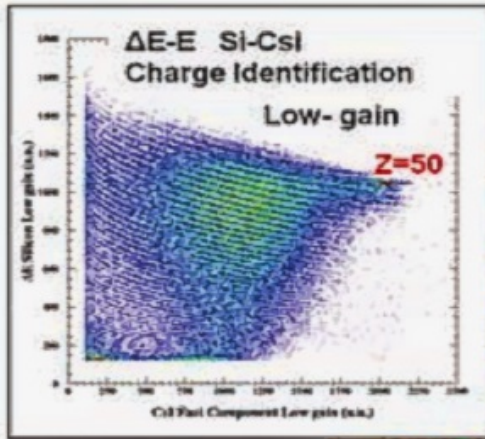



AutoHDR v2.1.8

www.autohdr.co.uk

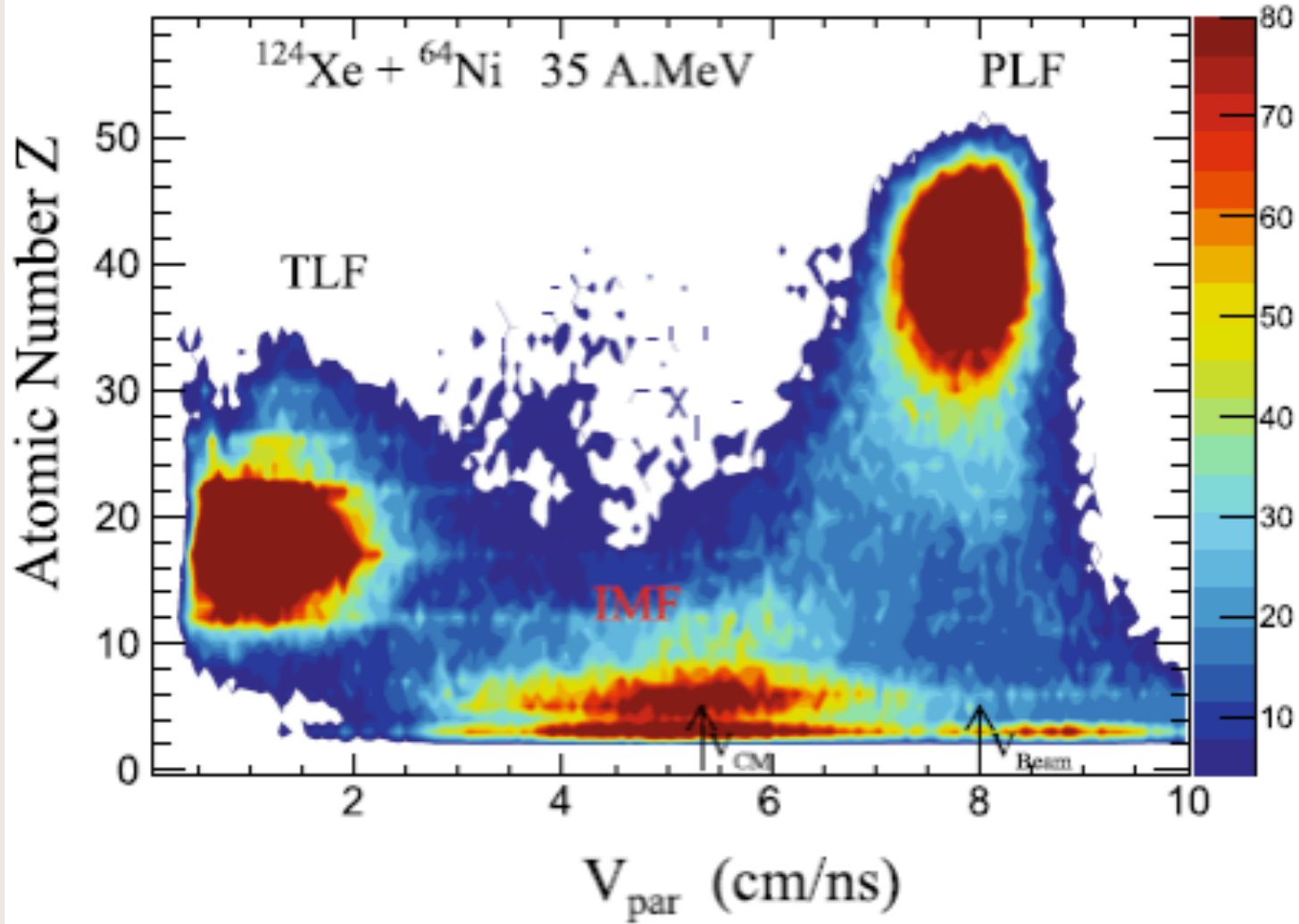
+ **neutron** detection (in development)



- 
- **Dynamical Fission** (fast, non-equilibrium break-up, leading to the emission of IMFs).
 - Mainly colinear with fission fragments
 - Rises with energy, N/Z of projectile and target, ...

A silver metal spiral binding is visible on the left side of the page, looping through a series of holes in the paper.

**MY BIGGEST CONTRIBUTION FOR THE
CHIMERA GROUP WAS ...**

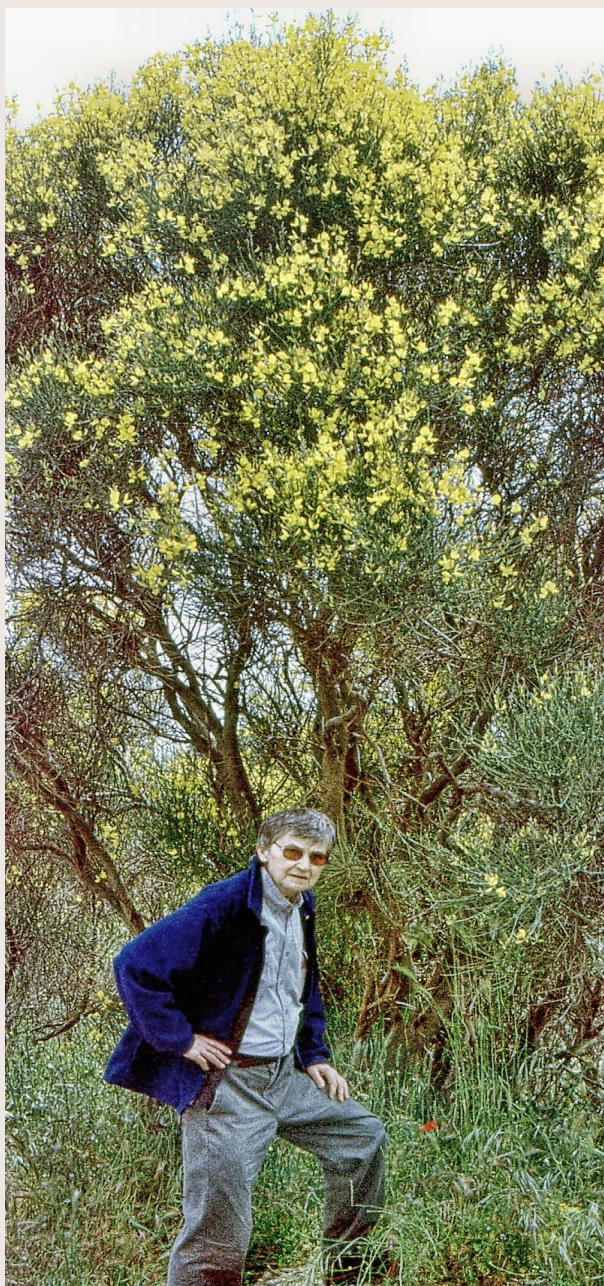

Janusz Wilczyński

2nd Wilczyński Plot

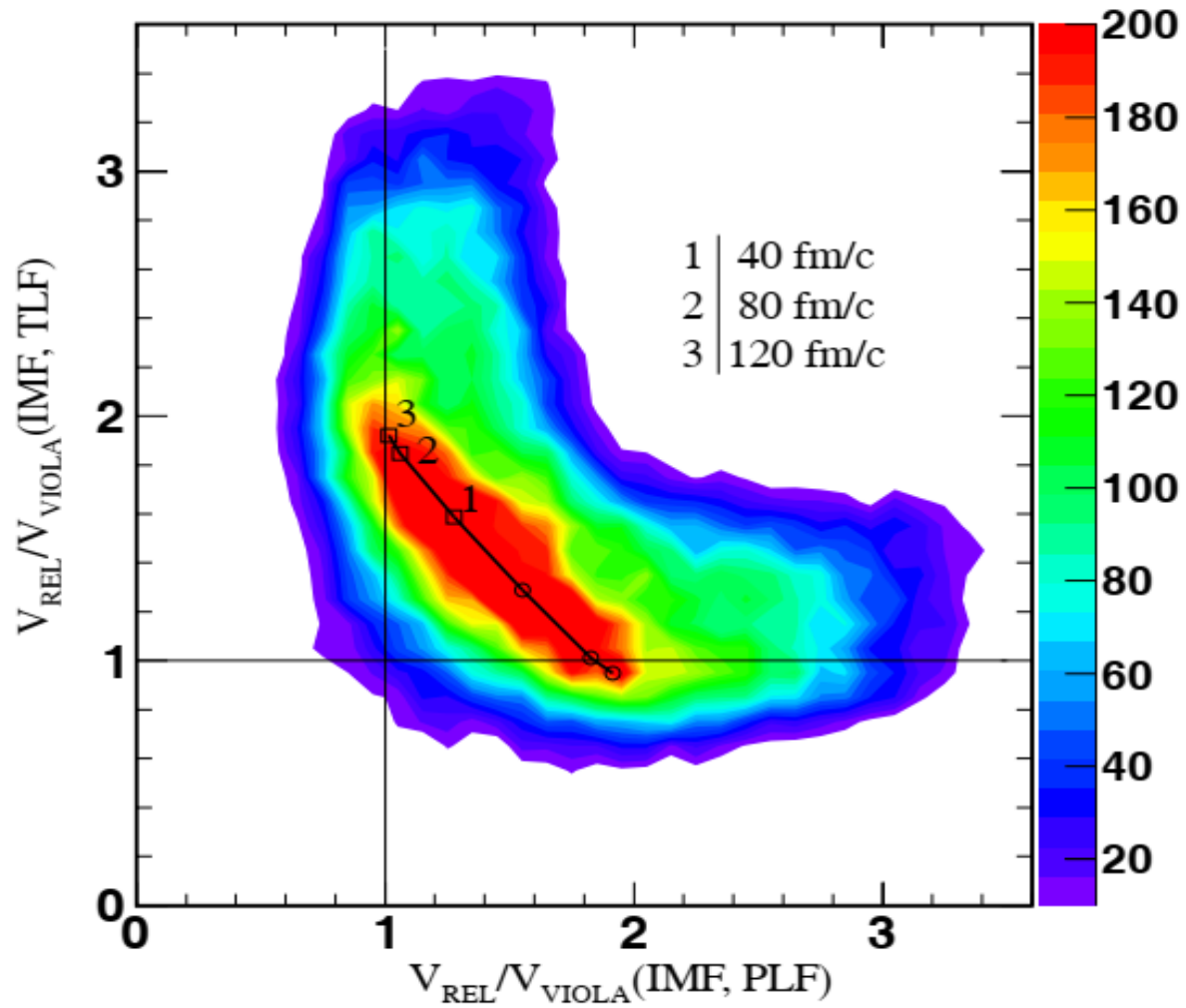

V_{REL} / V_{VIOLA} IMF-TLF

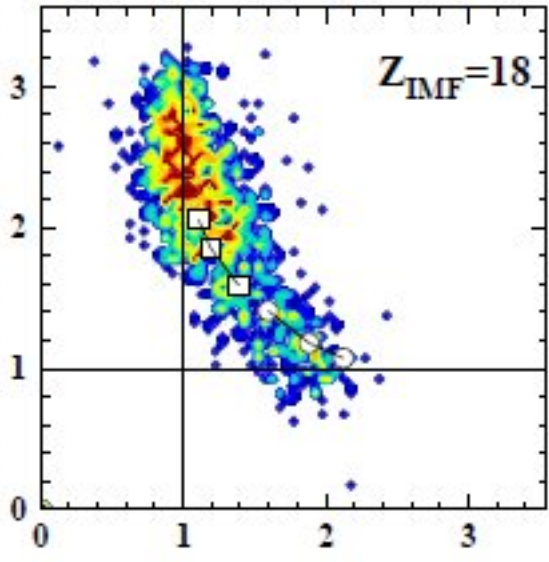
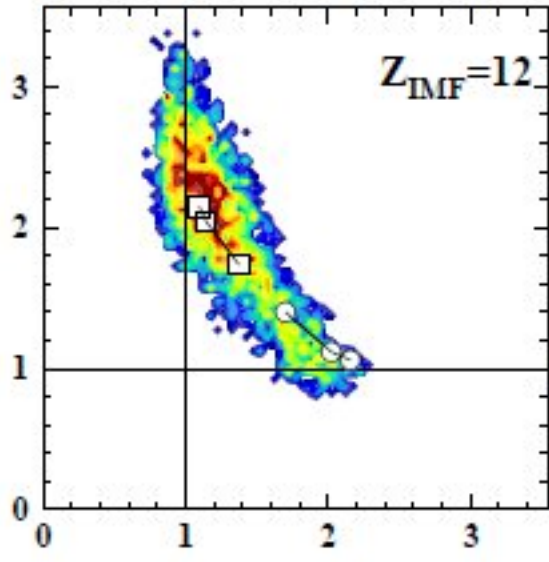
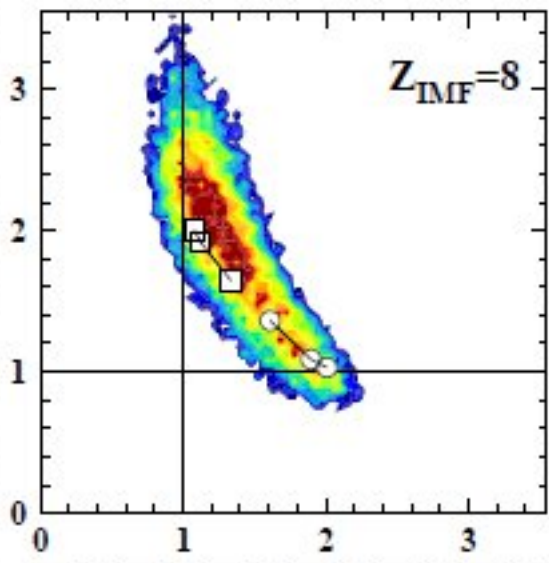
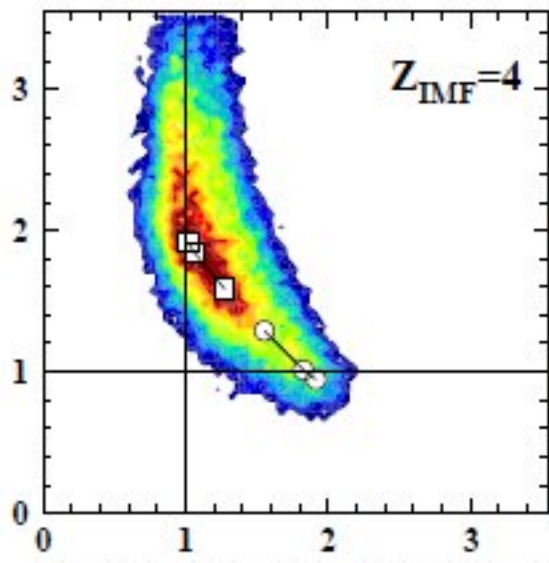

V_{REL} / V_{VIOLA} IMF-PLF

Dynamical fission as a tool

- Nuclear neck-density determination (**EOS**) with CHIMERA detector

Collaboration of LNS & HIL (Warsaw)

- Participation in the Chimera Collaboration (CT)
- Participation in the Coulomb Barriers experiments in Warsaw and Catania

Very preliminary results of experiment done using CHIMERA

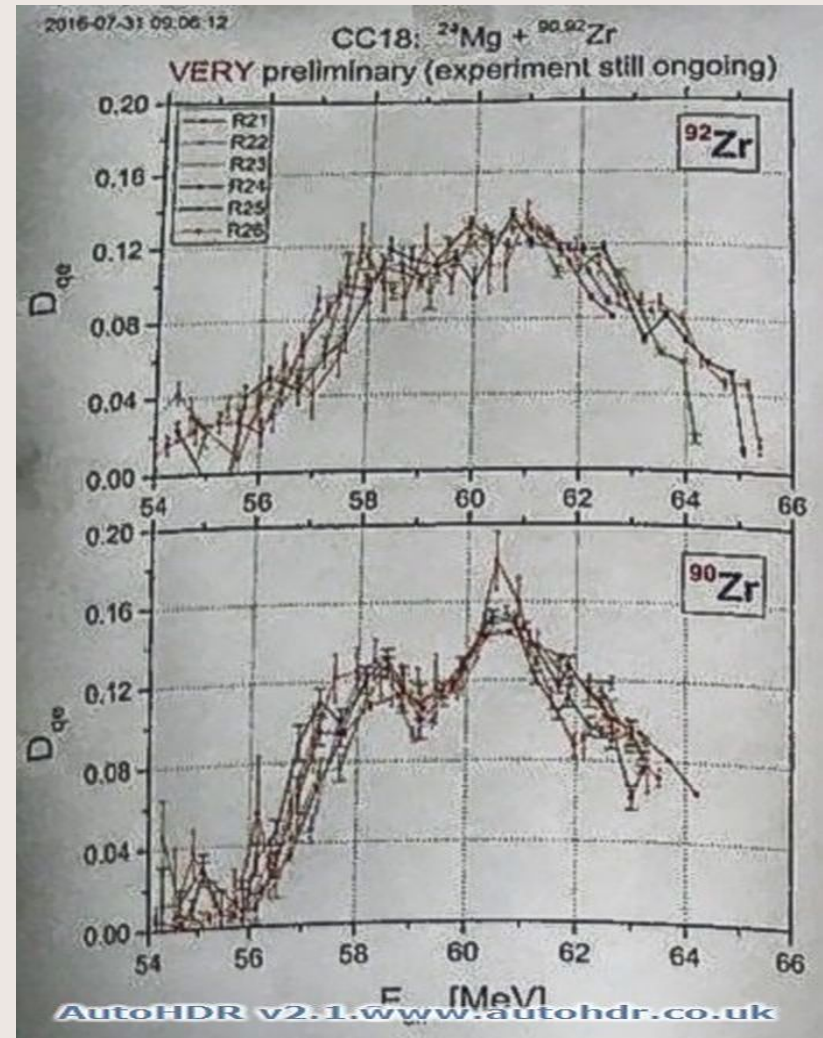

Participation of the LNS in the **Wien Filter** construction, necessary for the separation of **fusion products** from the **beam and elastics**

ANU (Canberra)

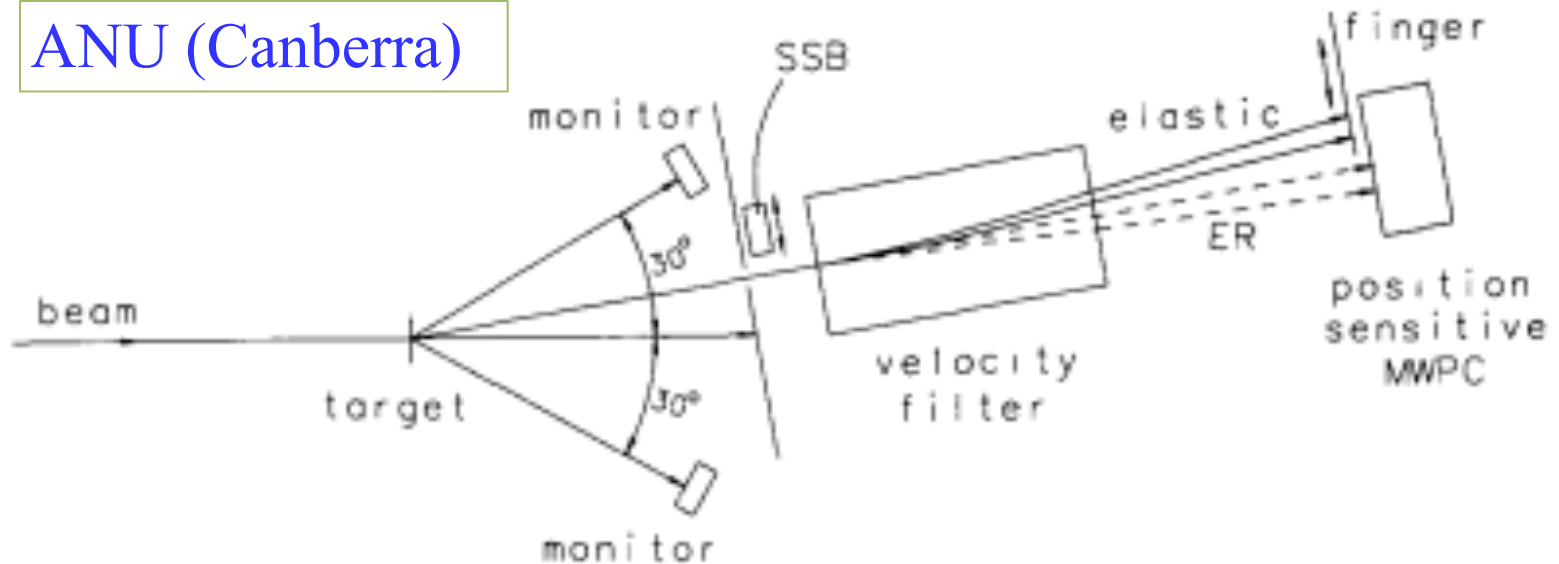

Deflection depends on v only
Efficiency $\sim 100\%$!



3 on beam tests of the the **Wien Filter** 2018.11.07
(LNS. Chamber 2000)

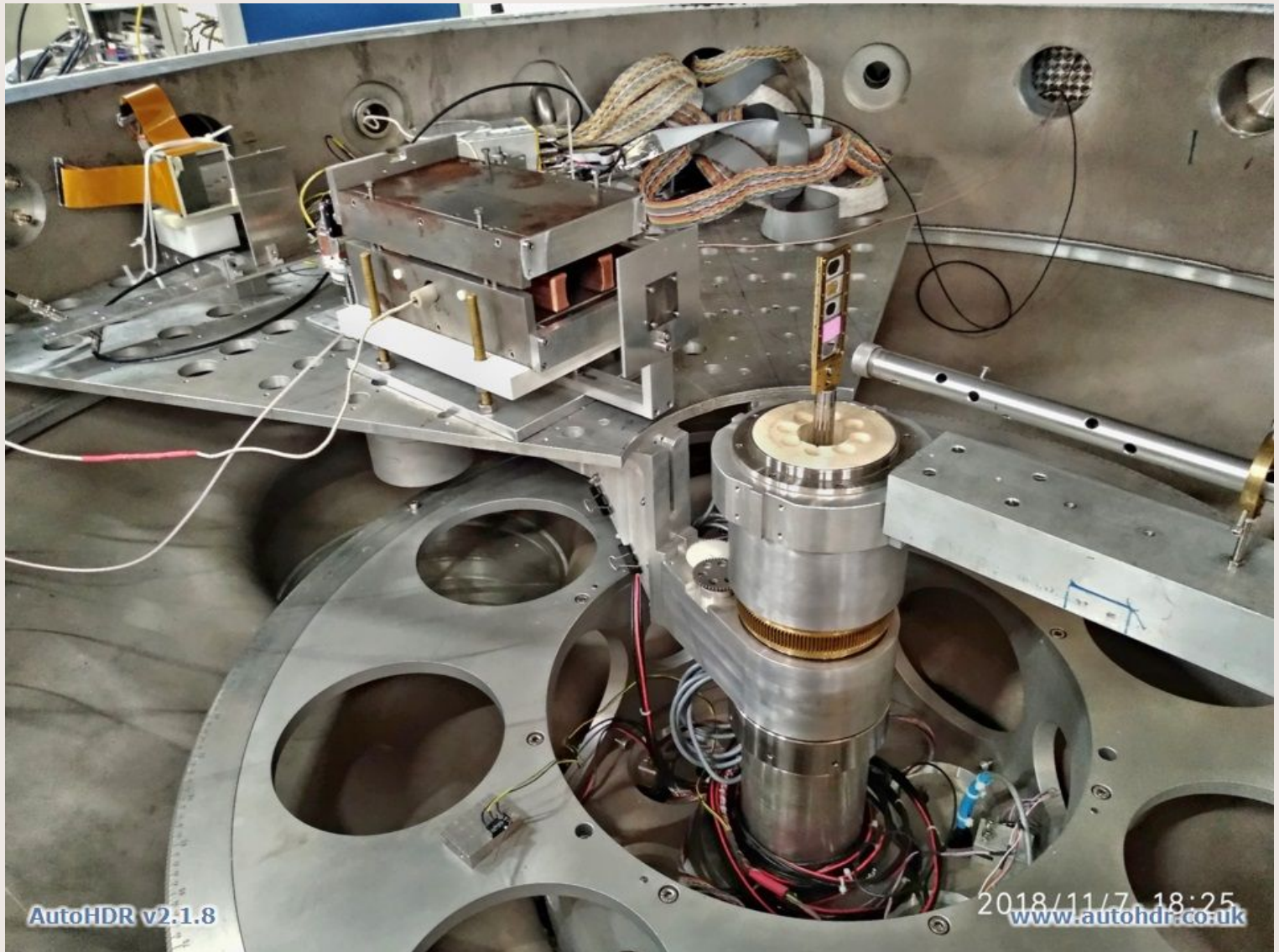

Angelo, as I will remember him



- **His expertise in physics**
- **Developing CHIMERA** not only using his brain, but also his hands
- **Reliability:** He always kept his promises and could be counted on
- **Courage:** He had the strength to make difficult decisions
- **Discussion skills:** He knew how to engage in meaningful conversations, not seeking conflict, not using *argumentum ad personam*. In general: avoiding any quarrels



And last, but not least:

Hospitality: His warmth and generosity made me always welcome

