

# Fermi Large Area Telescope

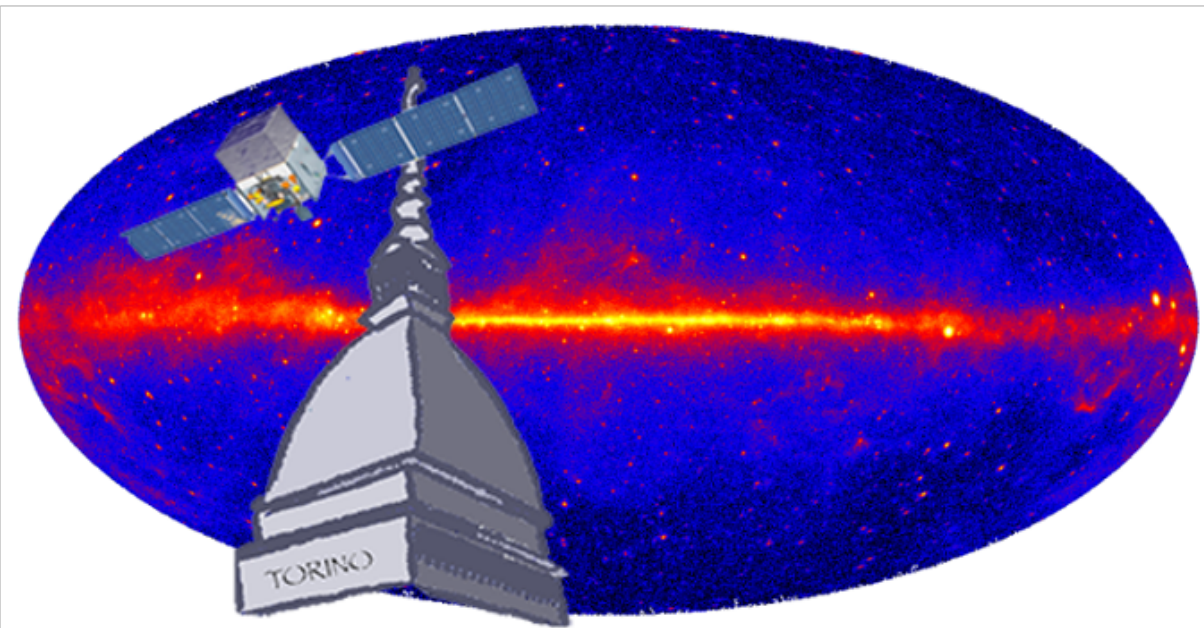

S. Maldera  
INFN - Torino

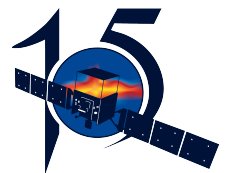

# Fermi Gamma-Ray space telescope

- Il Fermi Gamma-Ray Space Telescope e' una missione internazionale per l'esplorazione del cielo gamma per mezzo di due strumenti:
  - Gamma-ray Burst Monitor (GBM): 8 keV - 40 MeV
  - Large Area Telescope (LAT): 20 MeV - ~1TeV

Orbita quasi circolare

Altitudine: 565 km

Inclinazione: 25.6 deg

Periodo orbitale= ~90 minuti

Large Area Telescope (LAT)

Gamma-ray Burst Monitor (GBM)

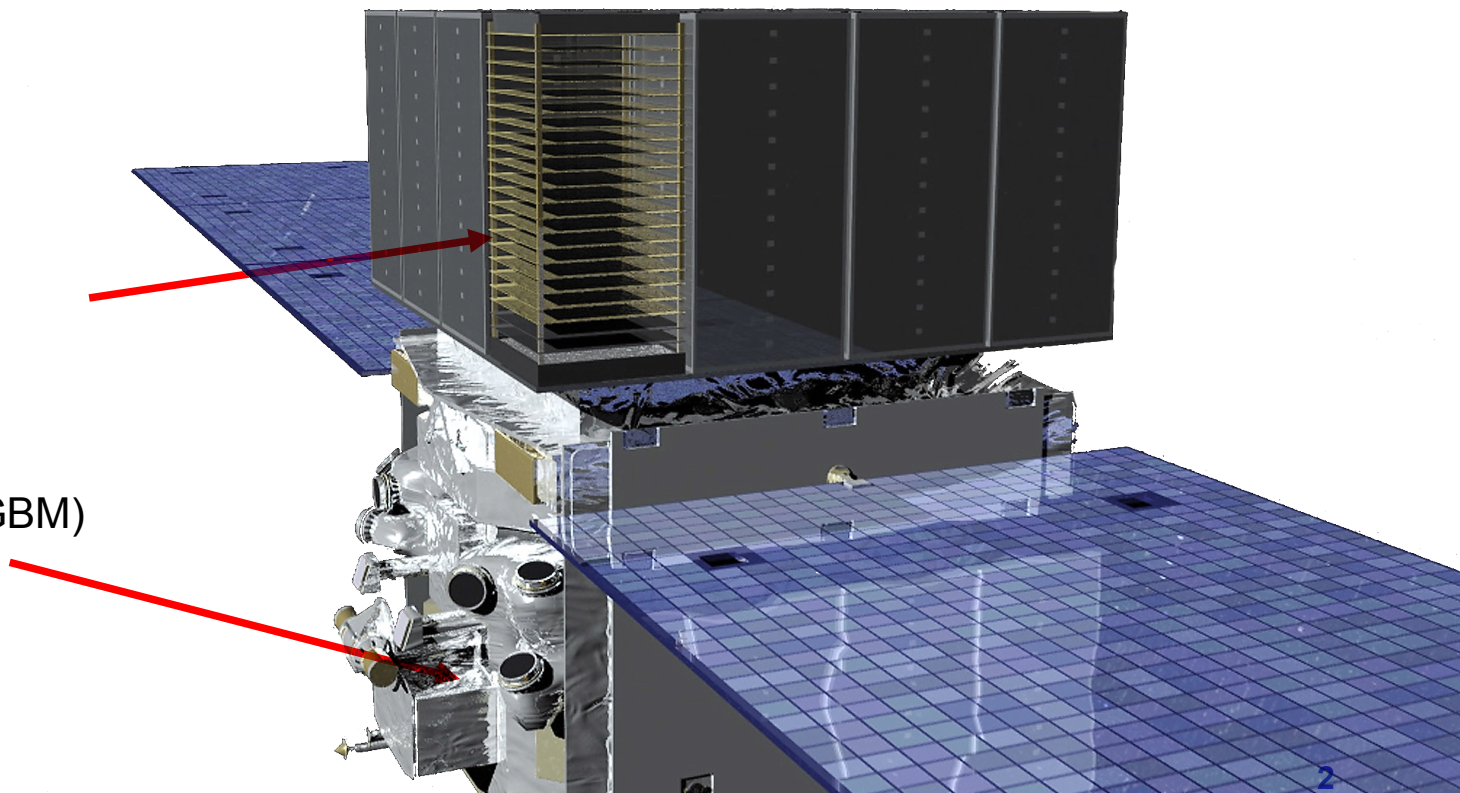



15 anni fa...



## The Launch

GLAST (later renamed Fermi) was launched on a Delta II rocket from Cape Canaveral on June 11, 2008 at 12:05 pm EDT.

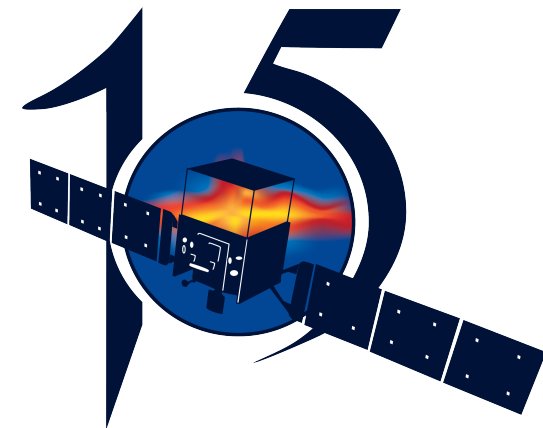

# Rivelazione fotoni gamma

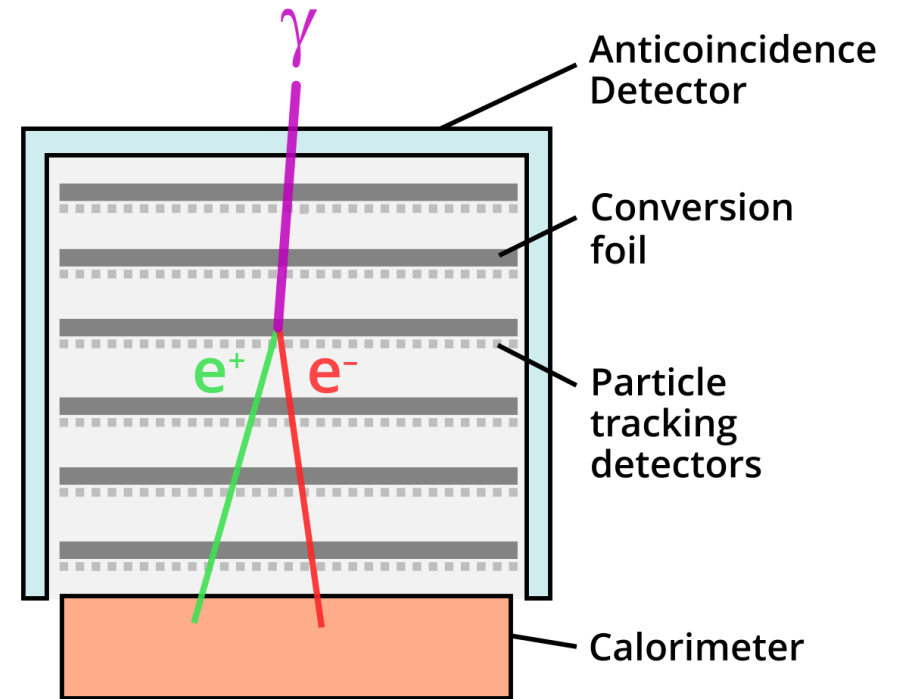
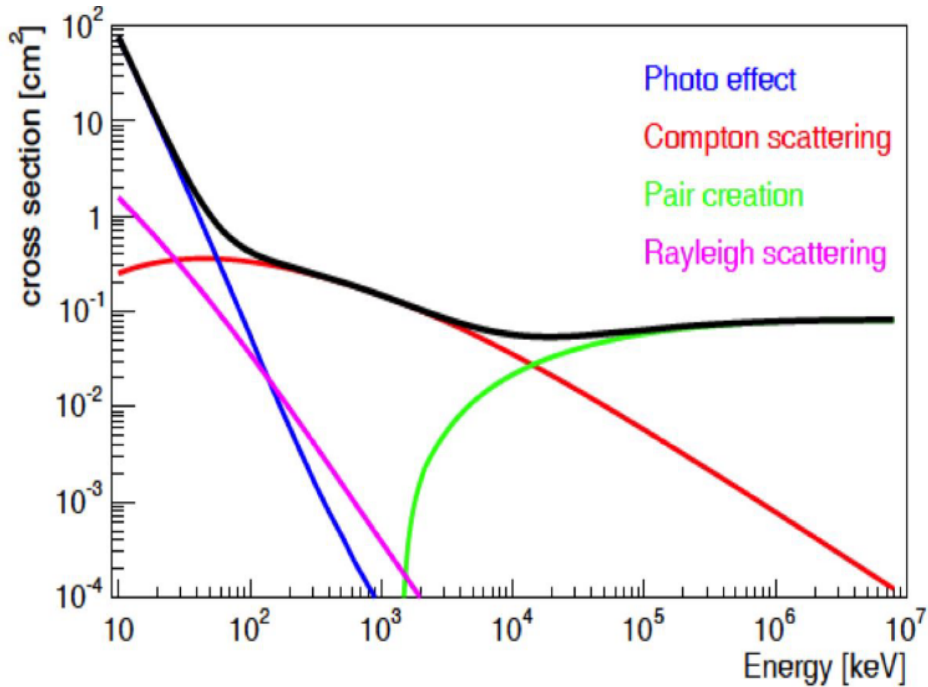

- La produzione di coppie  $e^+$   $e^-$  è il processo dominante per fotoni alle energie di interesse del LAT
- La coppia  $e^+$   $e^-$  fornisce indicazioni riguardo a energia e direzione di arrivo del fotone

# Large Area Telescope

## Fermi-LAT

Modular design with 3 subsystems. Calorimeter and Tracker organized in 4 modules

## Public Data Release:

All  $\gamma$ -ray data made public within 24 hours (usually less)

## Anti-Coincidence Detector:

Charged particle separation

## Si-Strip Tracker:

convert  $\gamma \rightarrow e^+e^-$   
reconstruct  $g$  direction  
EM v. hadron separation

## Hodoscopic CsI Calorimeter:

measure  $\gamma$  energy  
Image EM shower  
EM v. hadron separation

## Trigger and Filter:

Reduce data rate from  
 $\sim 10\text{kHz}$  to 300 - 500 Hz

## Sky Survey:

With 2.5 sr Field-of-View LAT  
sees the sky every 3 hours

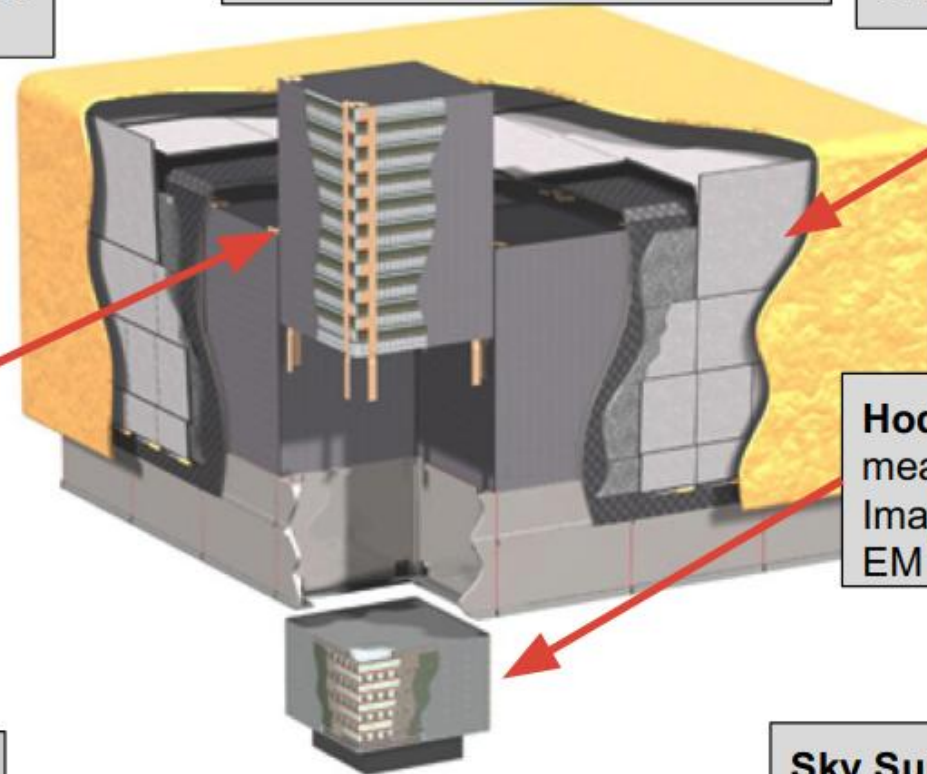



# LAT Tracker



18 bi-layers di silicon strip detector  
(piani x,y)

Intervallati 14 da fogli di tungsteno

spaziatura  $256 \mu\text{m}$

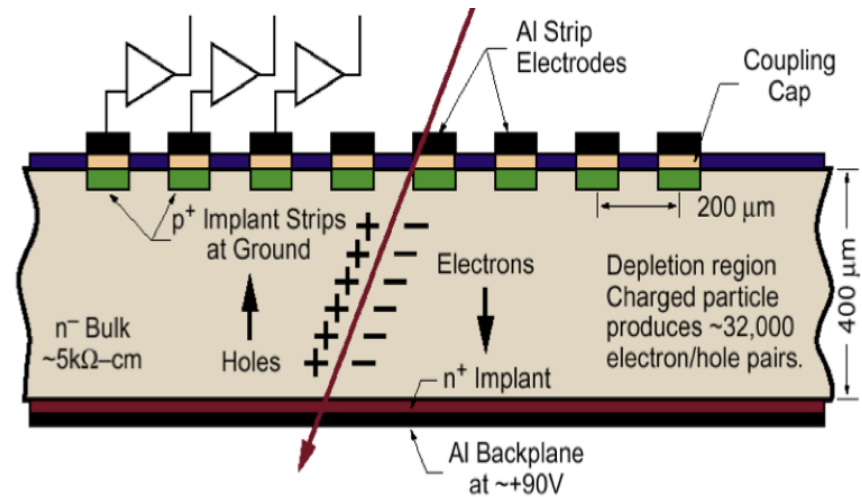
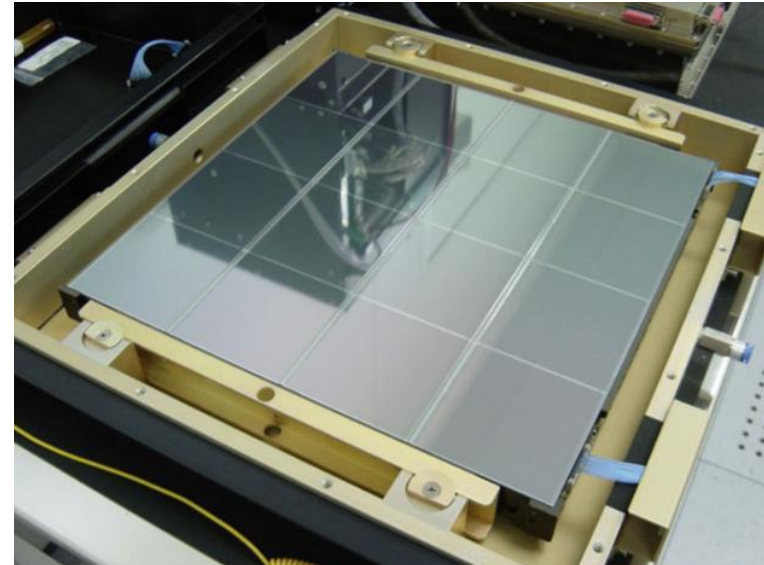

GLAST has 884736 channels. Total Tracker Power = 160 Watts!

# LAT Calorimeter

## Misura l'energia della coppia $e^- e^+$

- Ogni modulo e' formato da 8 strati di 12 cristalli CsI ortogonali tra loro
- Particelle cariche relativistiche producono una luce di scintillazione, raccolta alle estremità tramite 2 fotodiodi

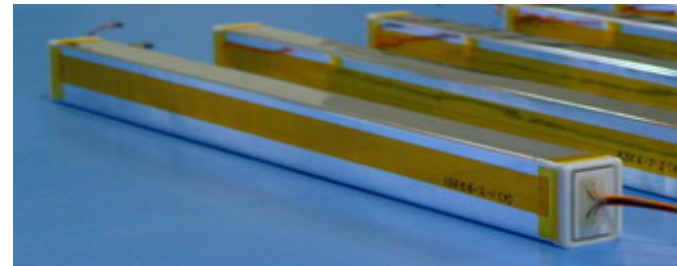
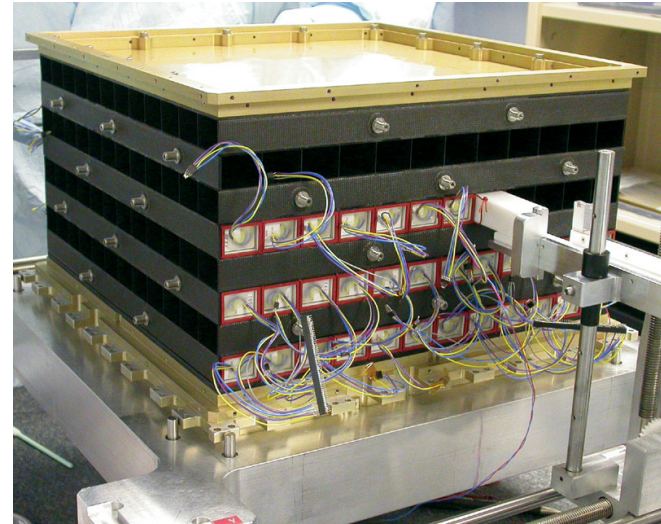

# LAT Calorimeter

## Misura l'energia della coppia $e^- e^+$

- Ogni modulo  $e'$  formato da 8 strati di 12 cristalli CsI ortogonali tra loro
- Particelle cariche relativistiche producono una luce di scintillazione, raccolta alle estremità tramite 2 fotodiodi

## Elettroni (e positroni) generano uno sciame elettromagnetico nel calorimetro

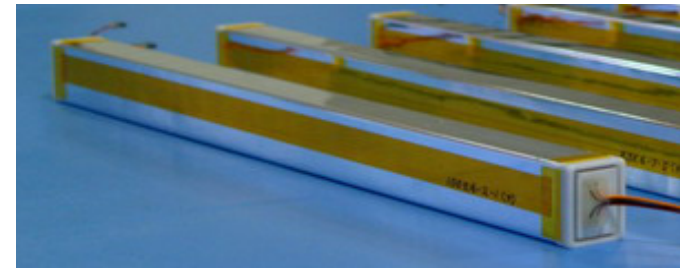
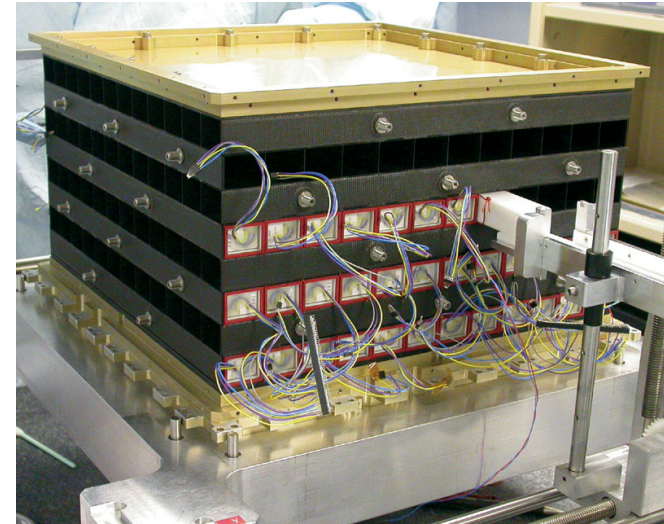
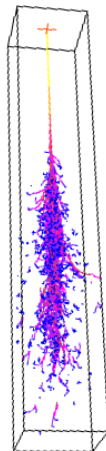
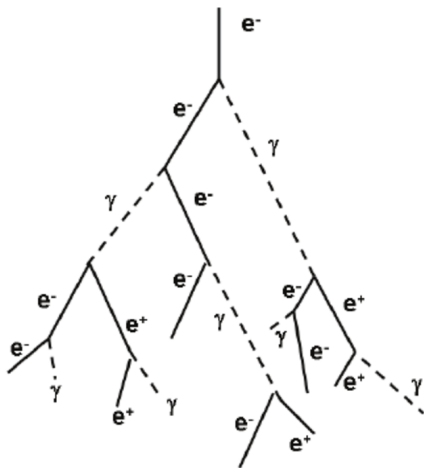

La segmentazione del calorimetro permette di misurare avere un'immagine dello sciame e.m.



# LAT Anticoincidence Detector (ACD)

**Identifica particelle cariche che entrano nel rivelatore**

- Le 16 torri (tracker+cal) sono circondate da 89 piastrelle di scintillatore plastico
- Luce raccolta tramite fibre ottiche e portata a 2 fotomoltiplicatori

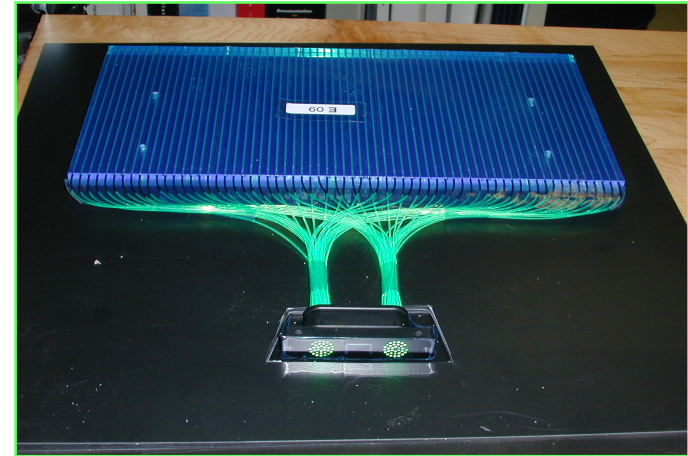

**Segmentazione riduce il self-veto (backsplash dal calorimetro)**

**Alta efficienza (~99.97%)**

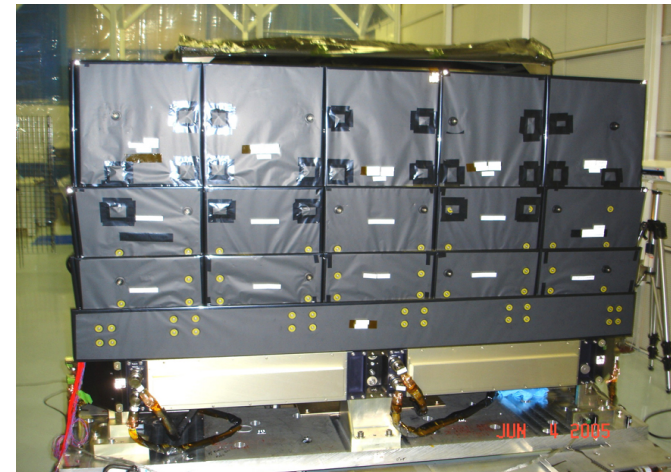

# Fermi pronto per il lancio...

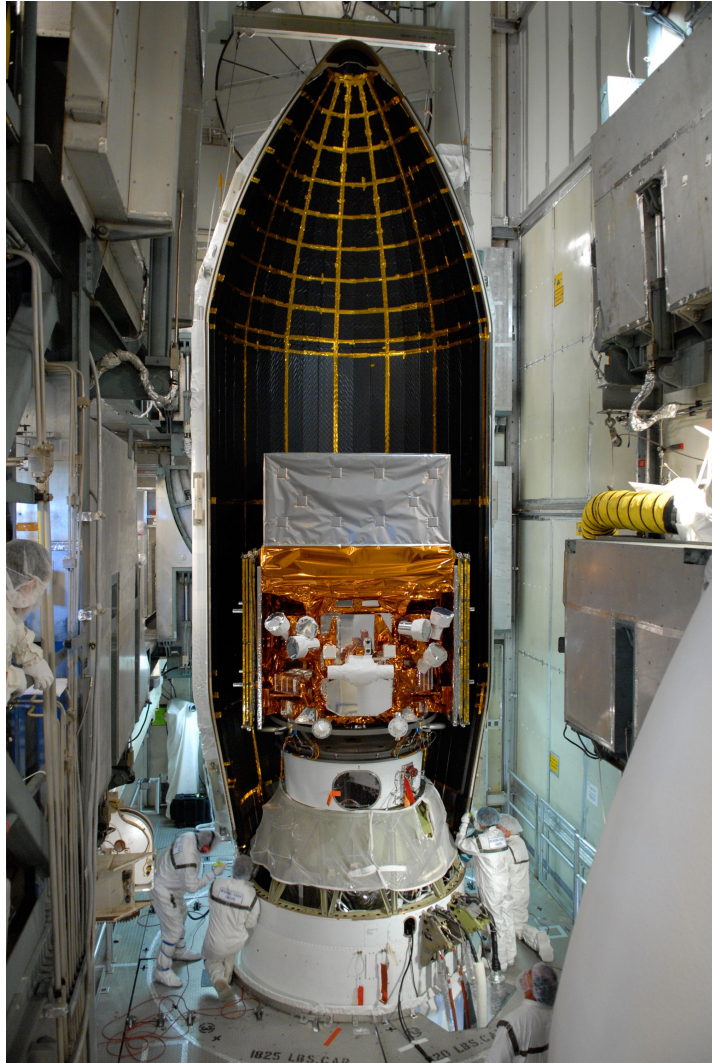

# Ricostruzione degli eventi

## A partire dai segnali nei rivelatori vogliamo:

- eliminare (o studiare) le particelle cariche (background)
- ricostruire la direzione di arrivo
- ricostruire l'energia



# Fotone gamma nel LAT

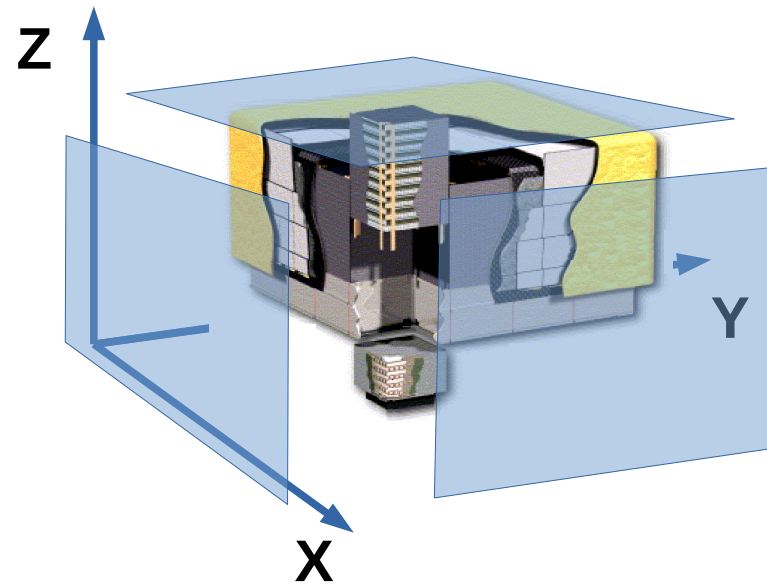
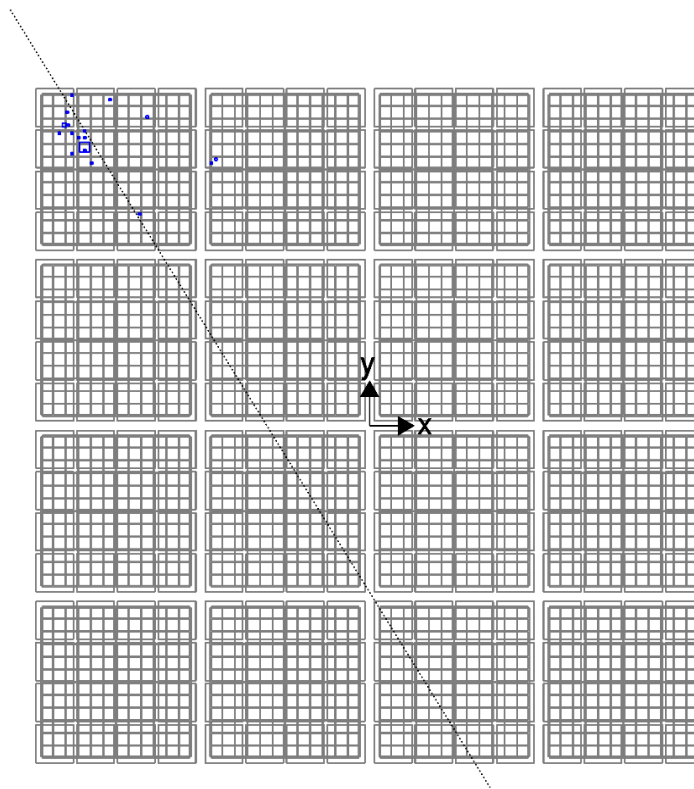
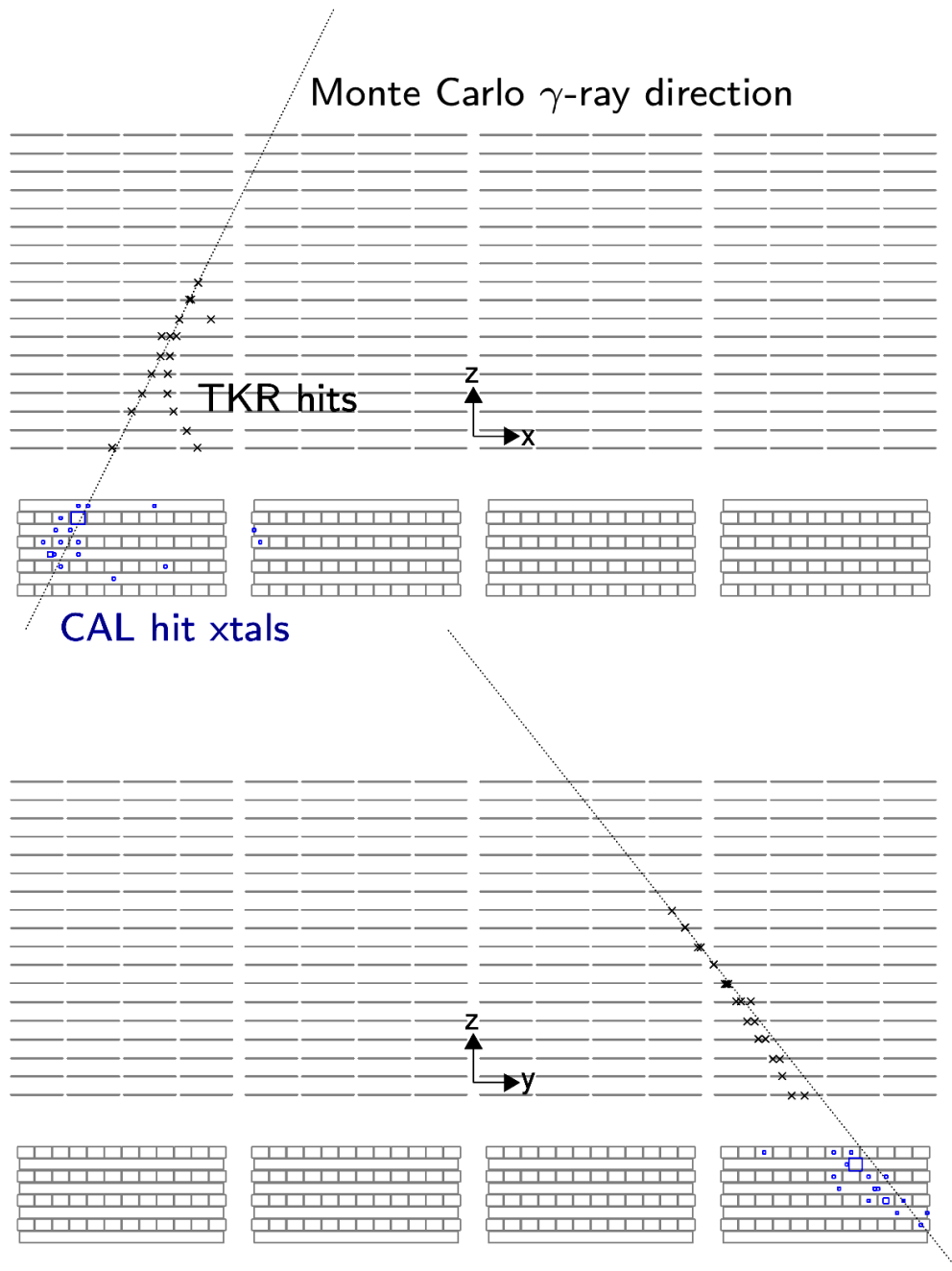

# Evento background nel LAT (protone ~1GeV)

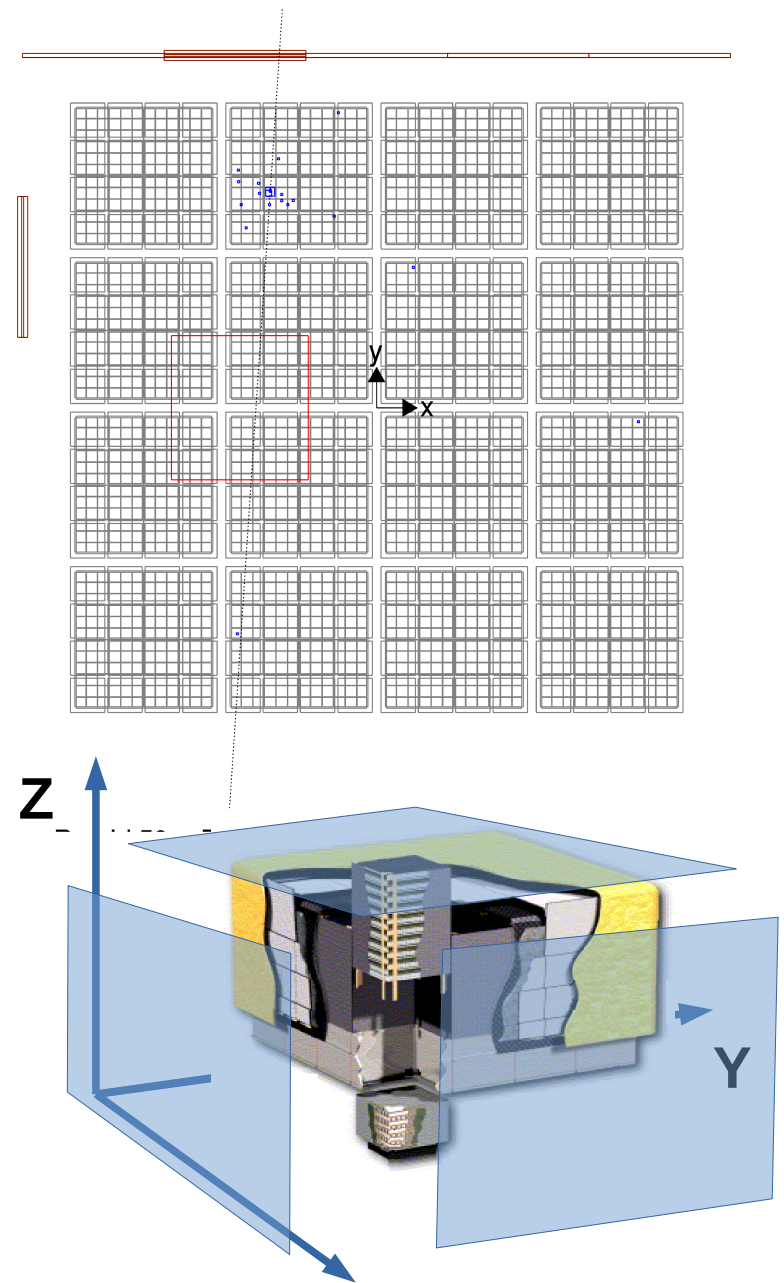
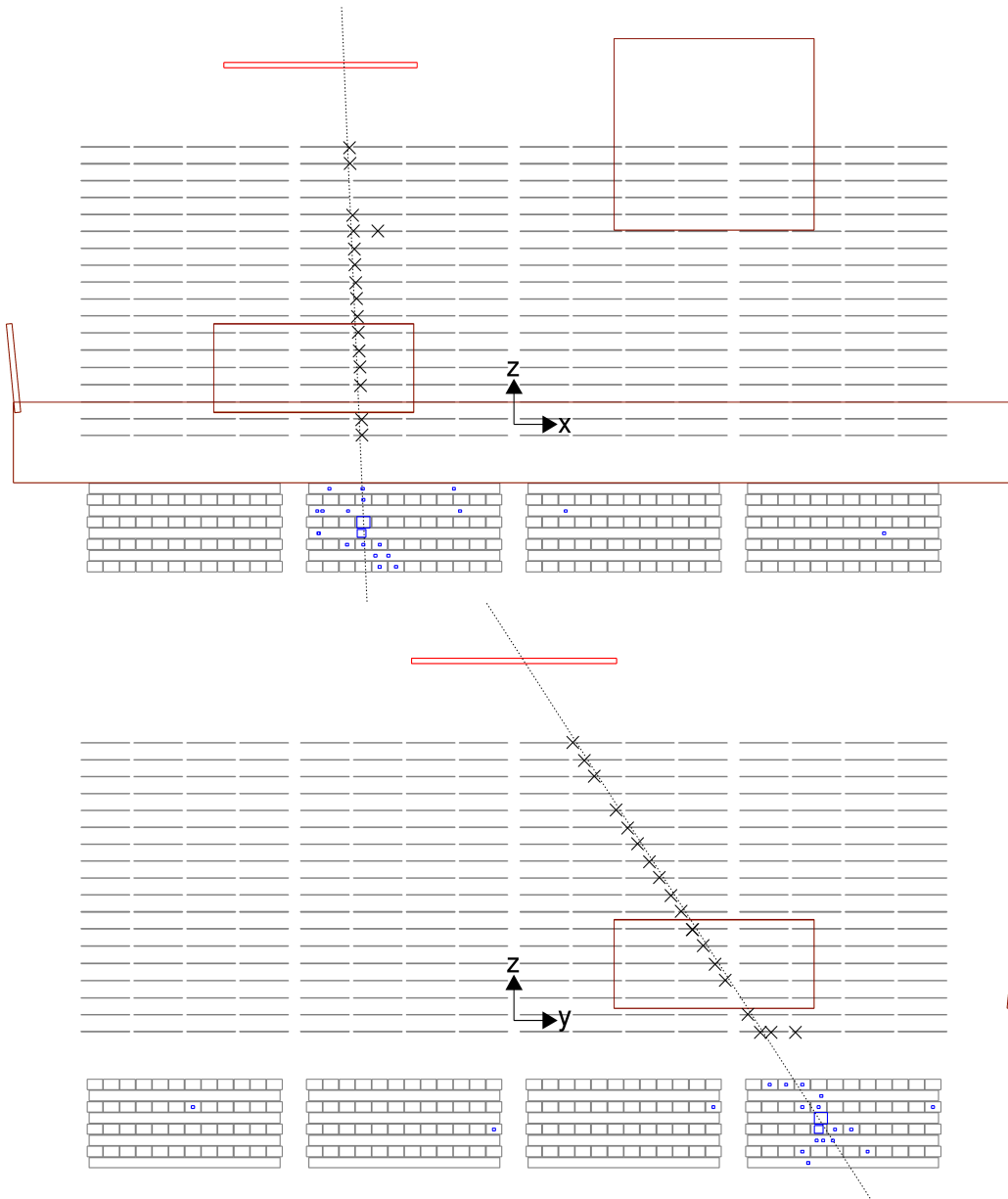

# Flussi all'orbita di Fermi

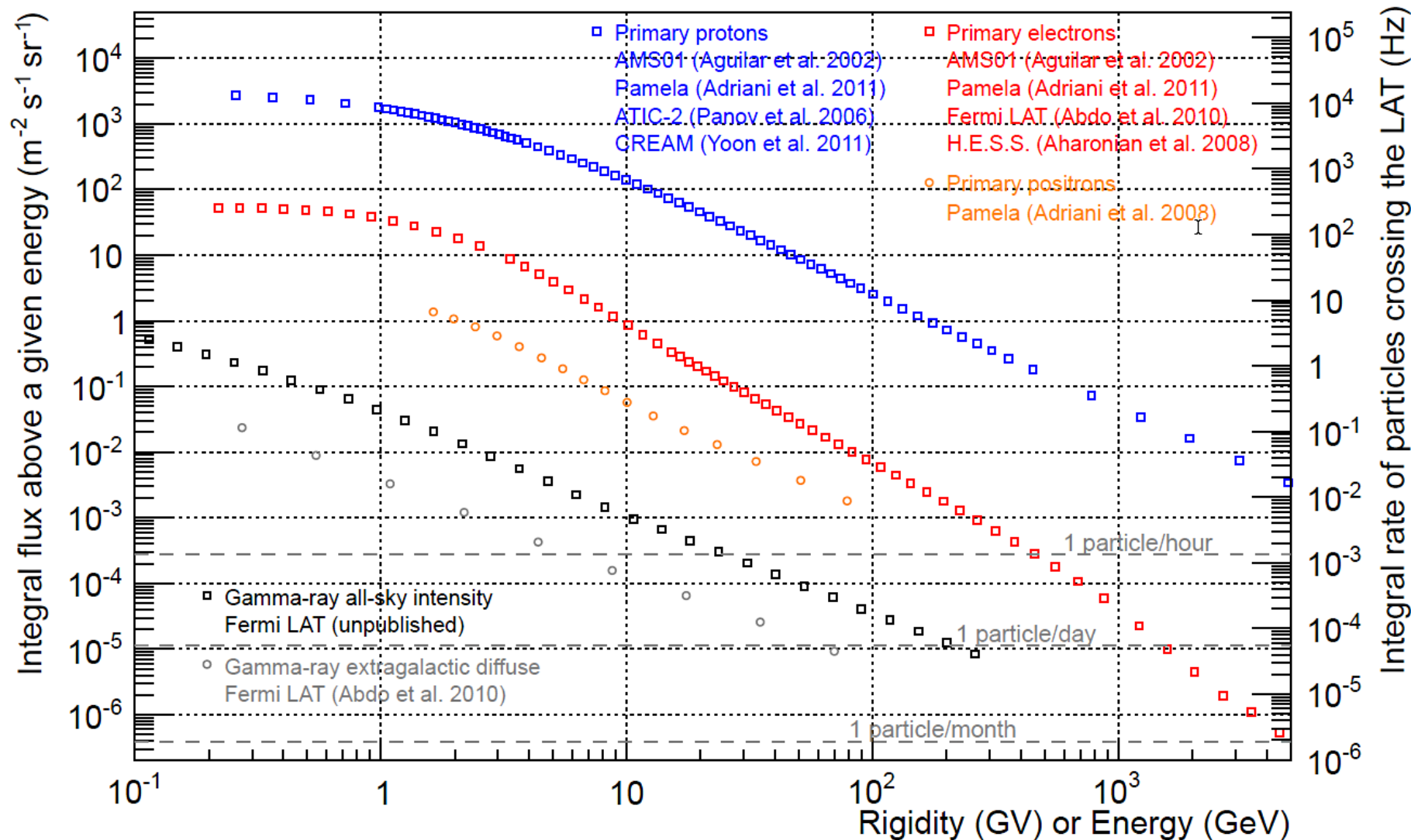

**necessaria una riduzione del background di un fattore  $\sim 10^6$**

ACD + "forma" dello sciame nel calorimetro



# Sciame elettromagnetico vs sciame 'adronico'

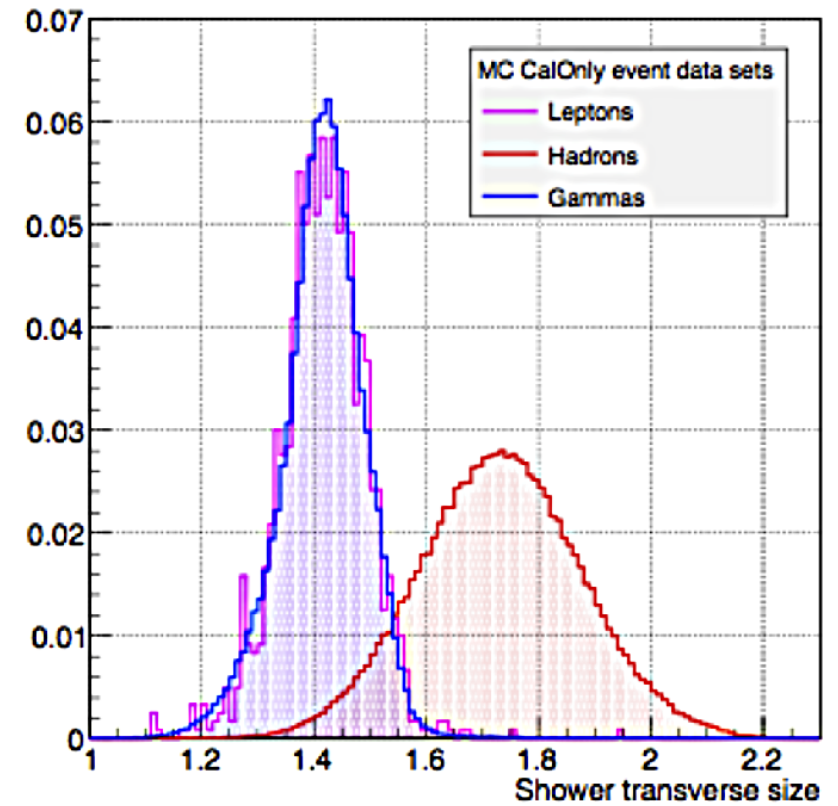
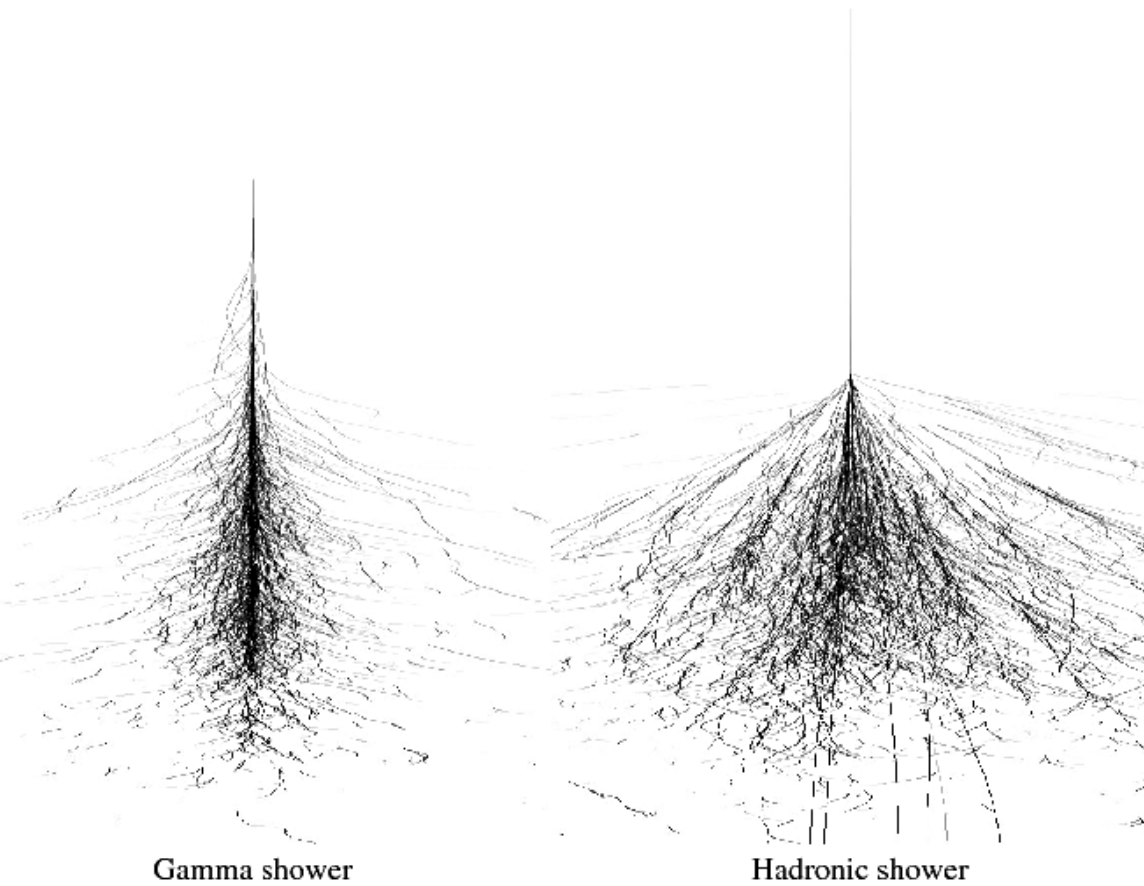

# LAT Performances

P8R3\_SOURCE\_V2 acc. weighted PSF

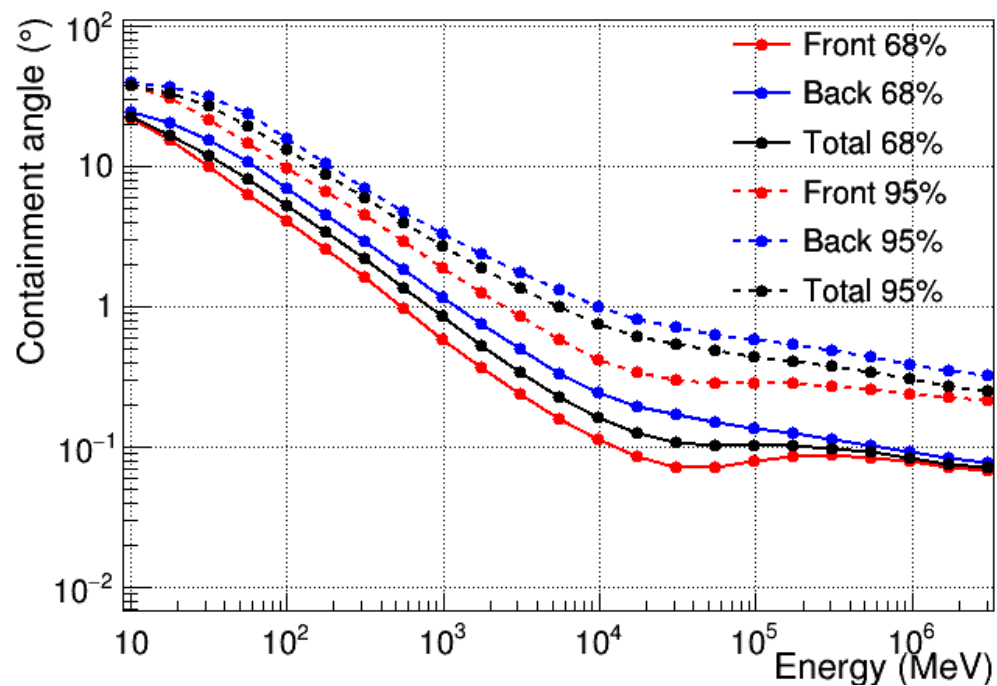

P8R3\_SOURCE\_V2 acc. weighted energy resolution

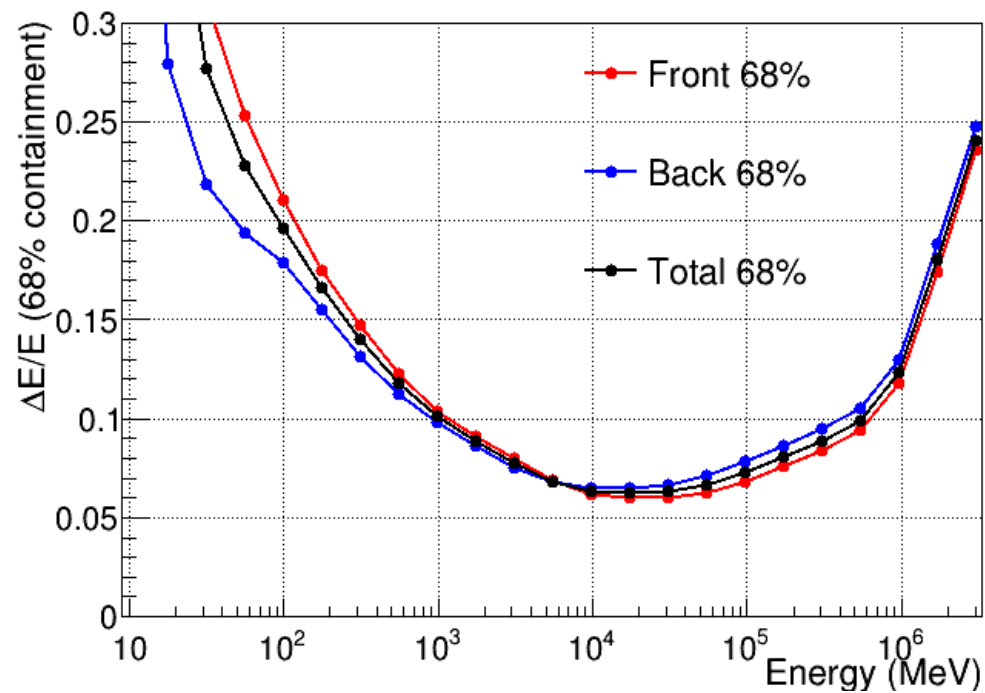

# Data processing

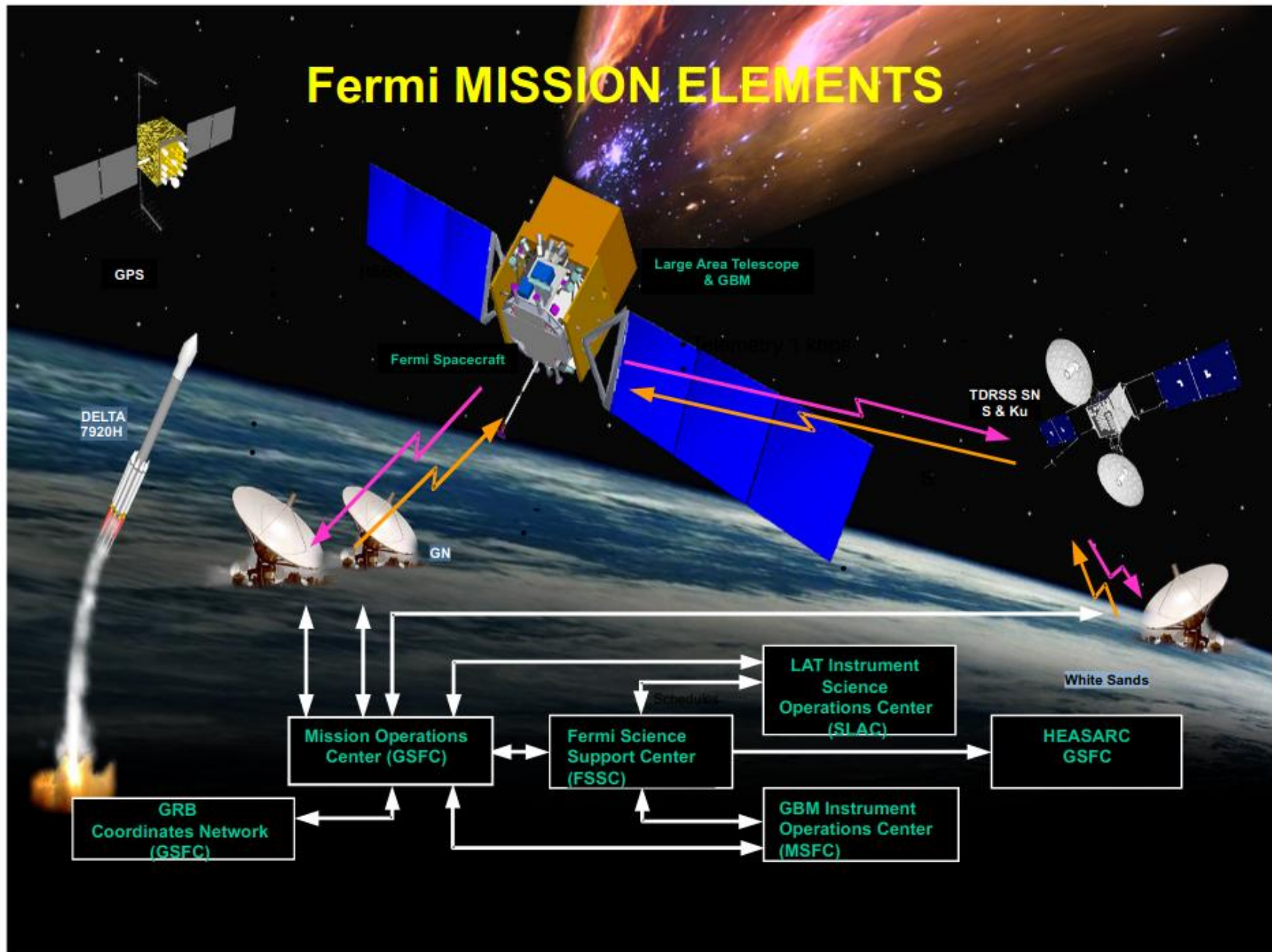

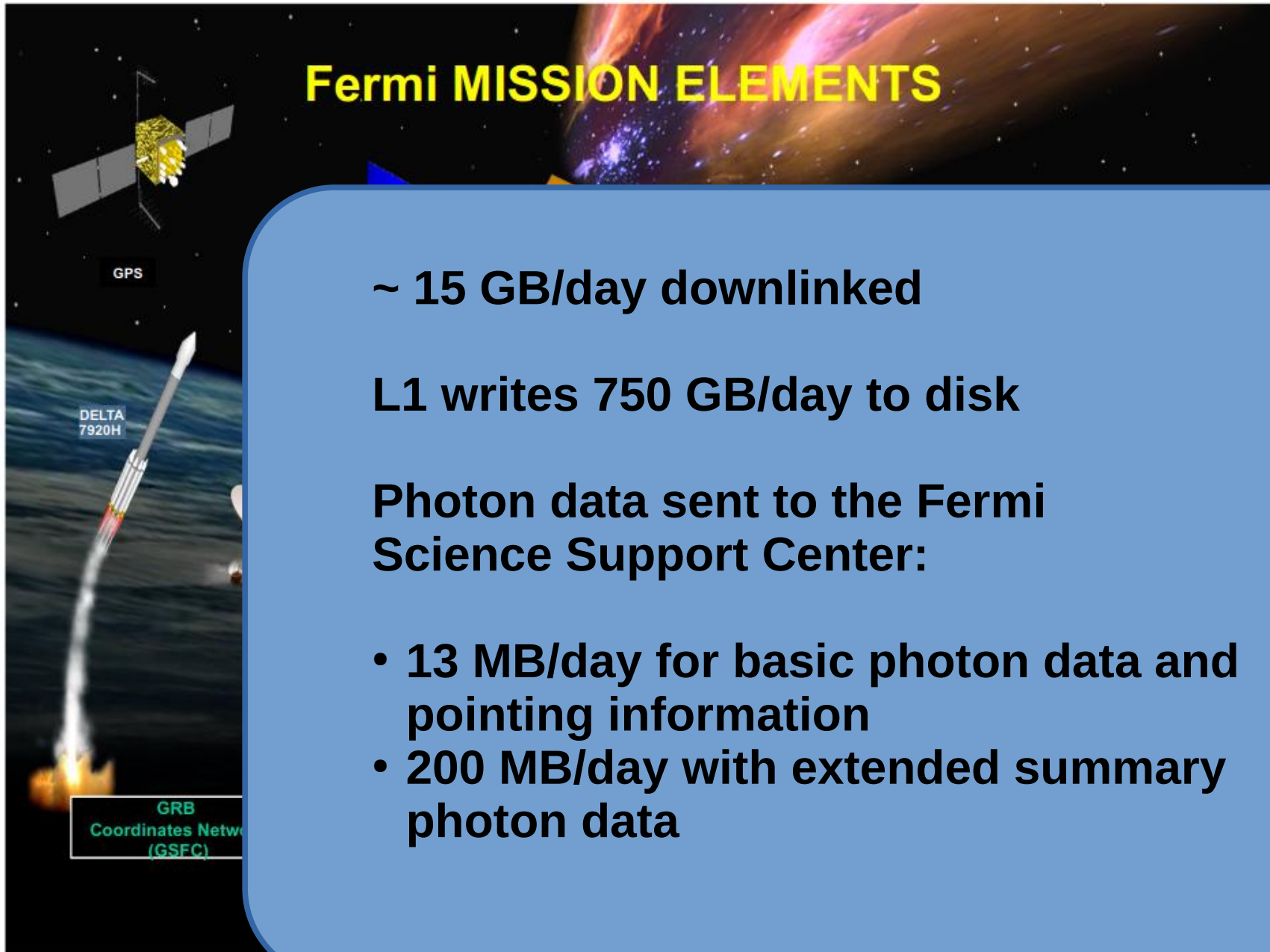

# Data processing

A composite image showing the Fermi satellite in orbit, a Delta 7920H rocket launching, and a GRB Coordinates Network (GSFC) logo. The background features a colorful nebula. The text 'Fermi MISSION ELEMENTS' is overlaid in yellow.

**Fermi MISSION ELEMENTS**

GPS

DELTA 7920H

GRB Coordinates Network (GSFC)

~ 15 GB/day downlinked

L1 writes 750 GB/day to disk

Photon data sent to the Fermi Science Support Center:

- 13 MB/day for basic photon data and pointing information
- 200 MB/day with extended summary photon data

# Eventi gamma

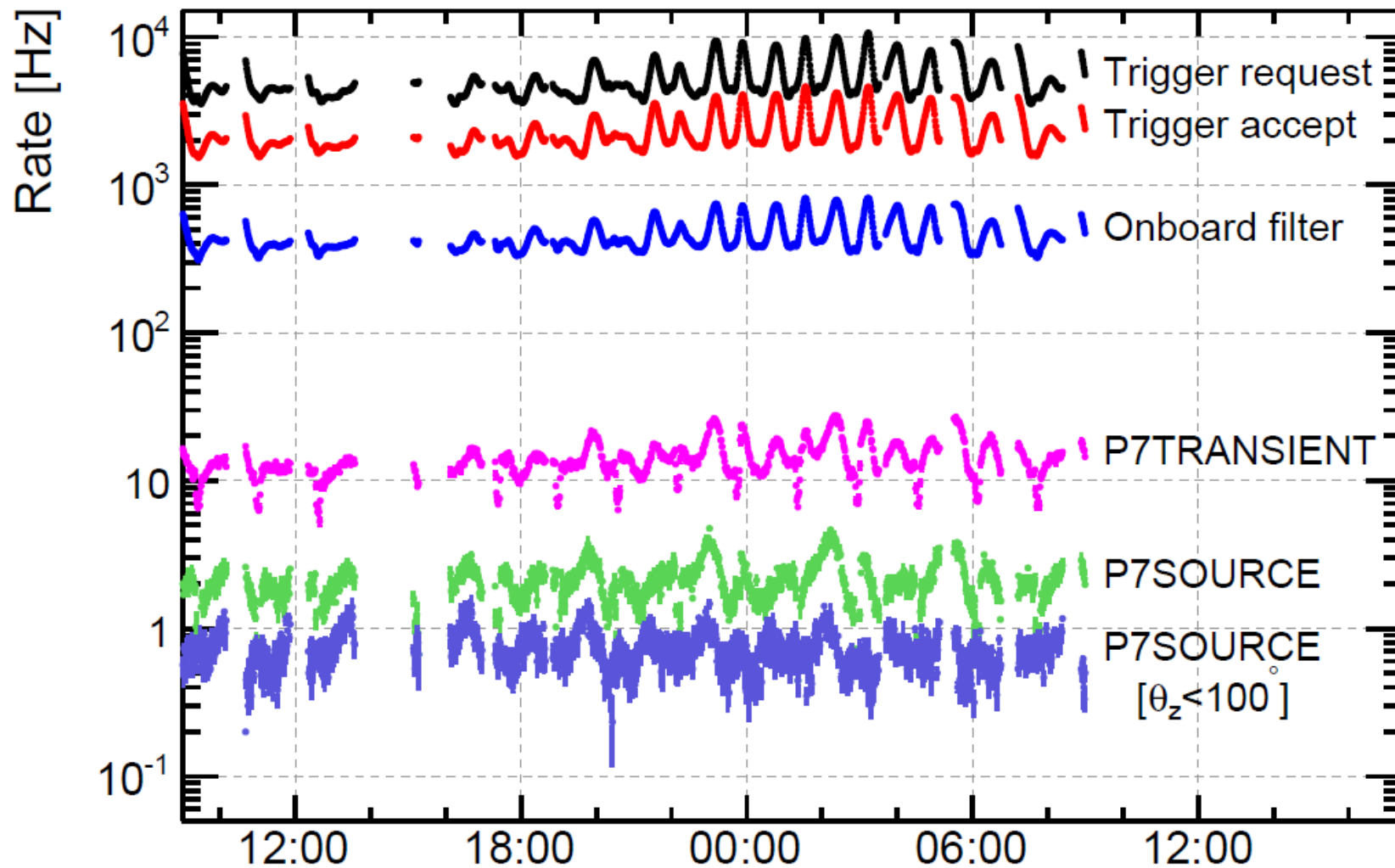



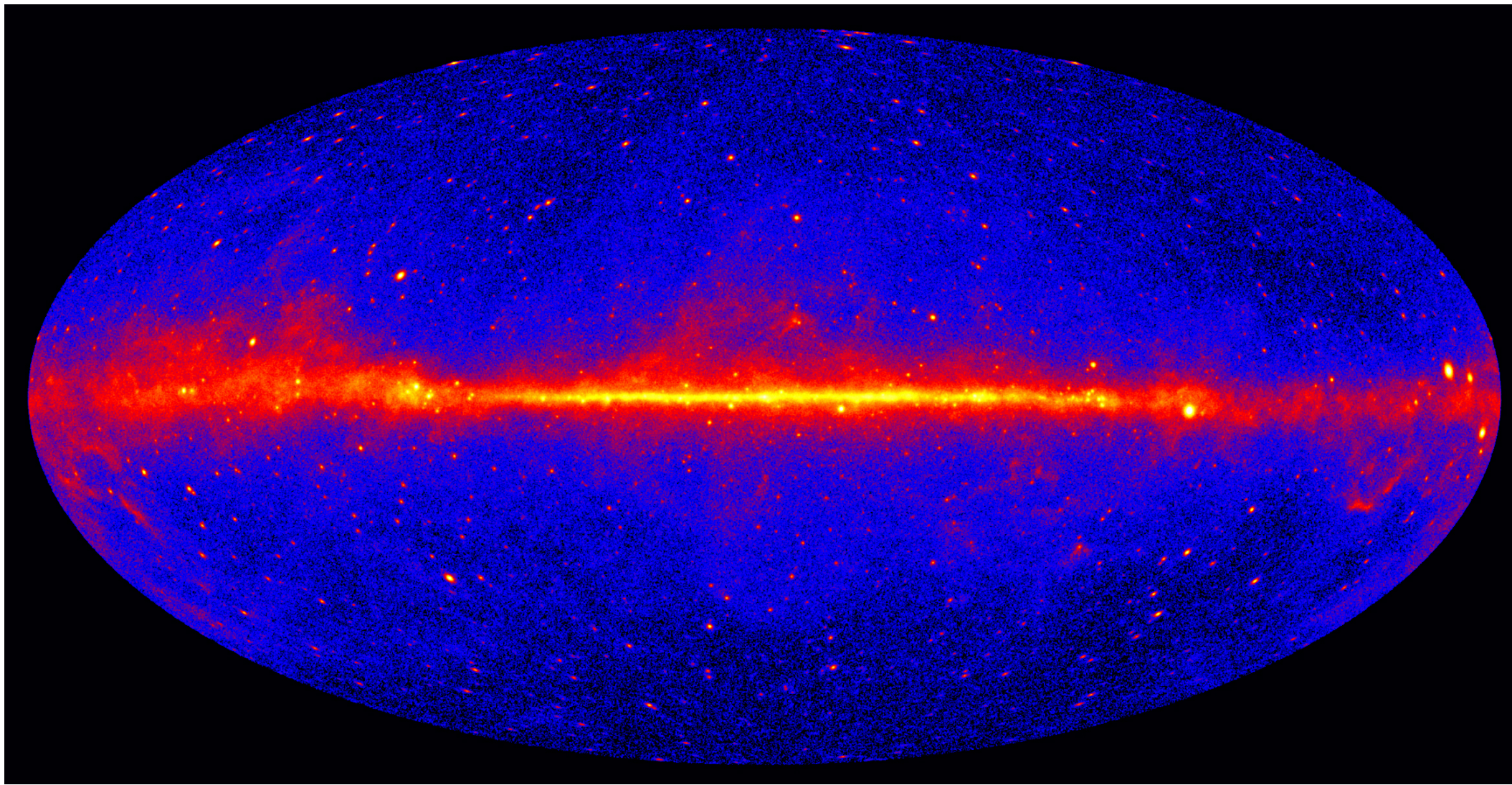





# Kahoot!

Game PIN

Enter

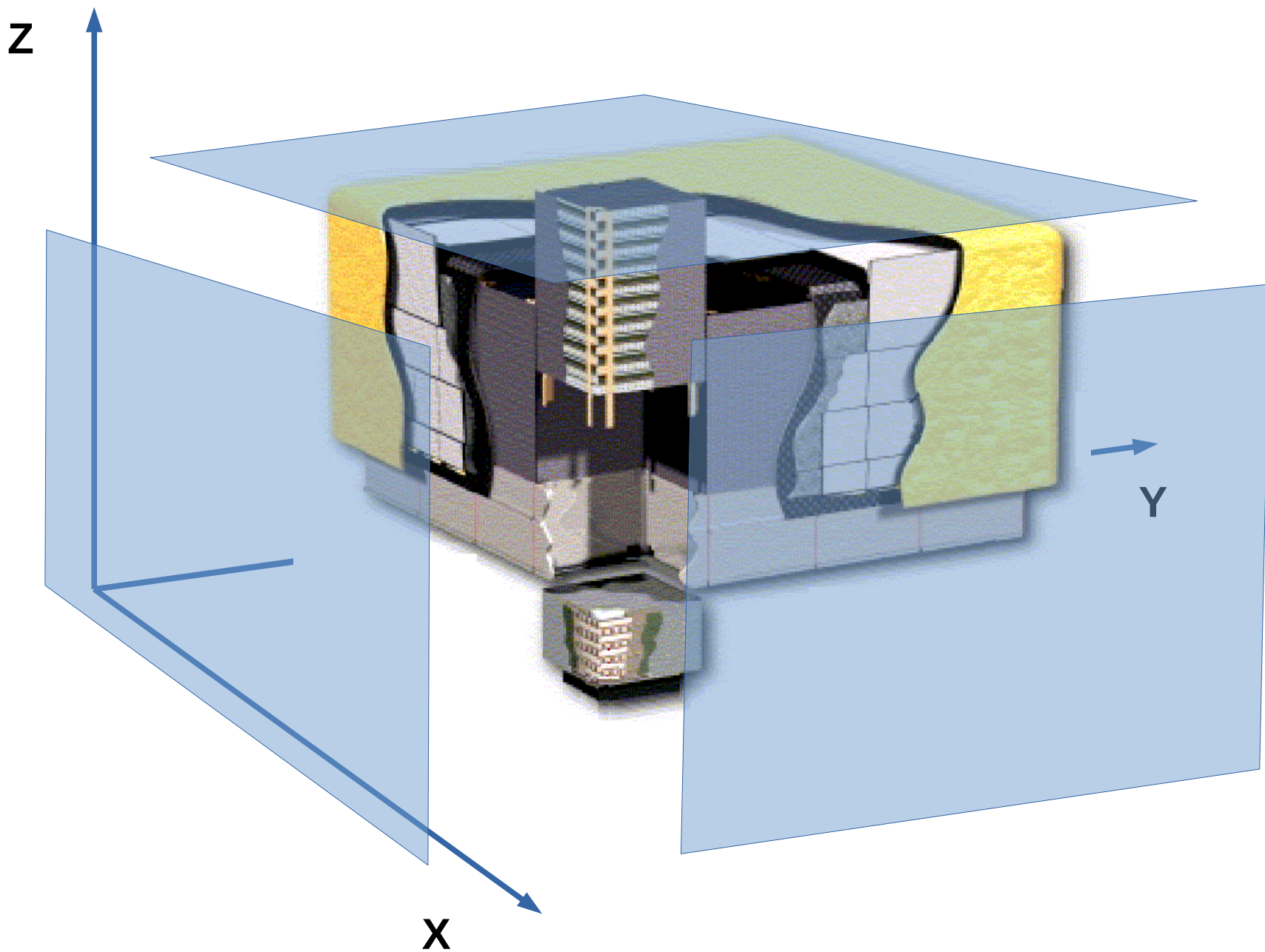



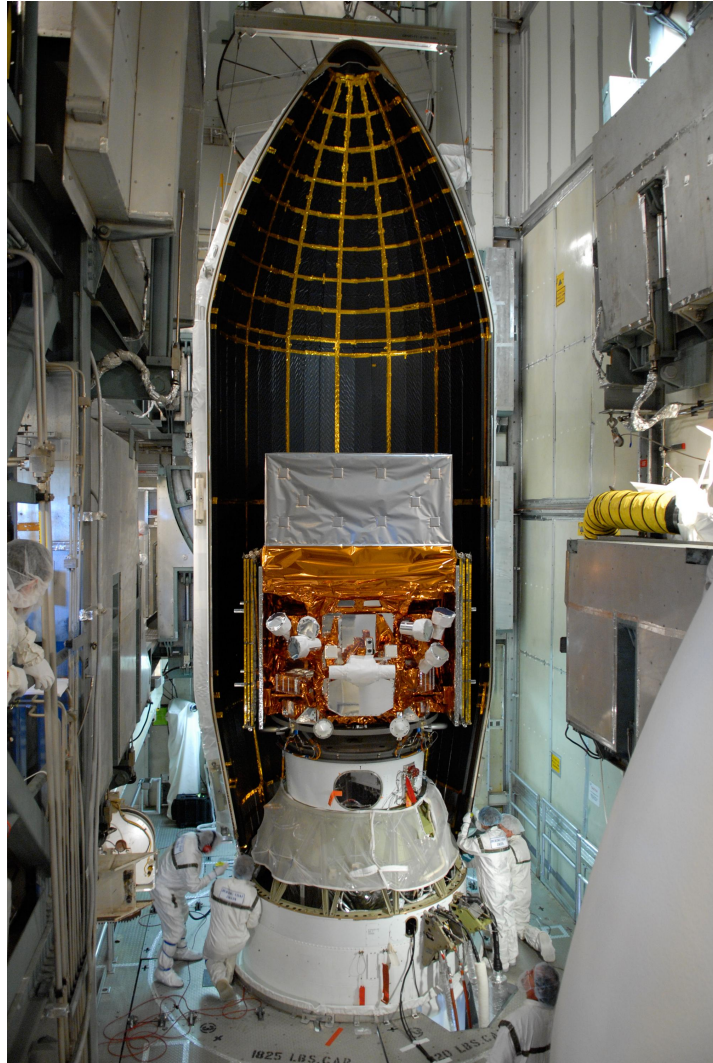

# LAT Performances

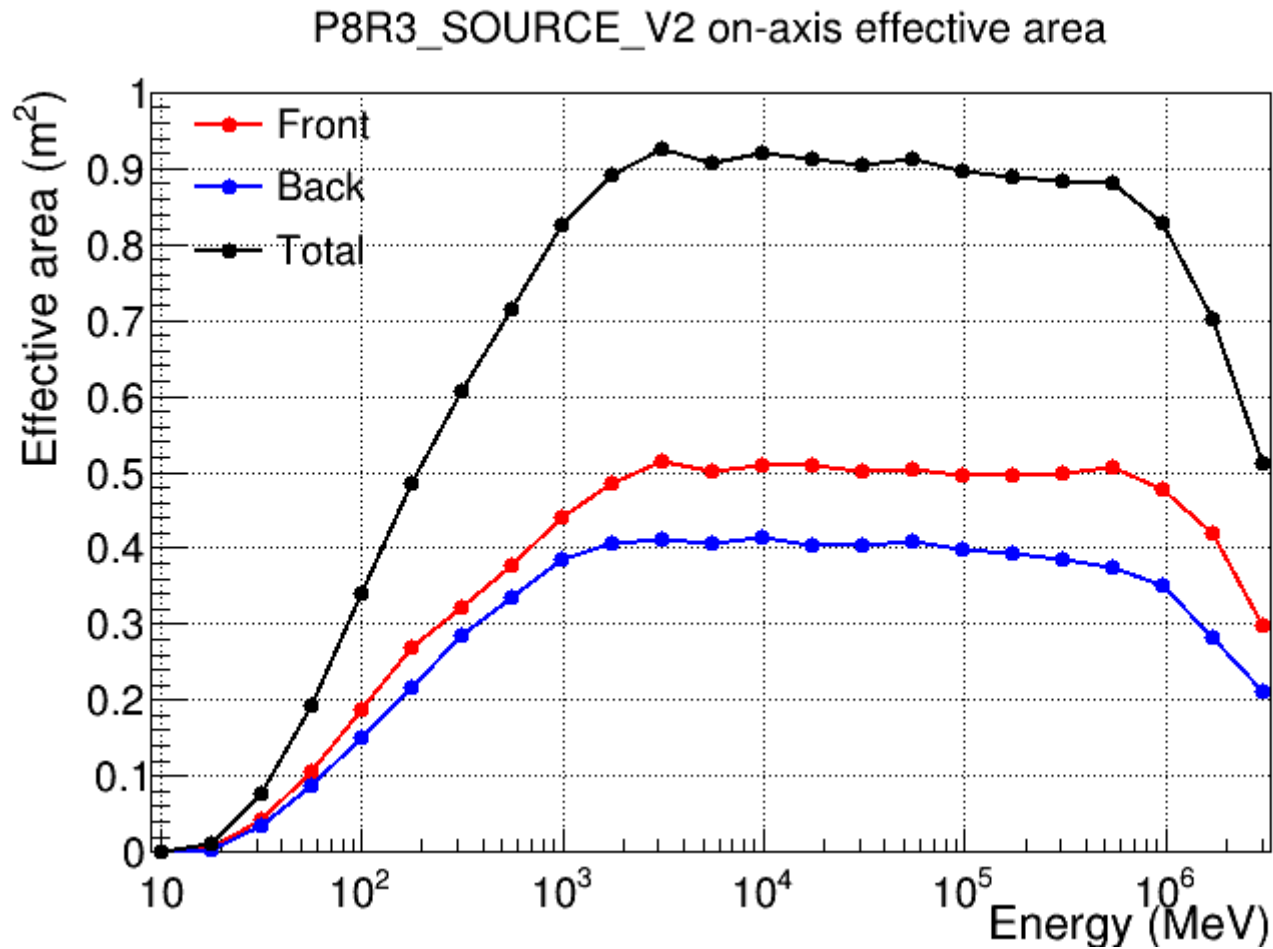

# How many gammas?

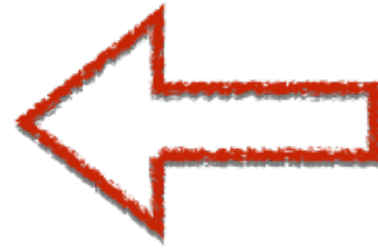
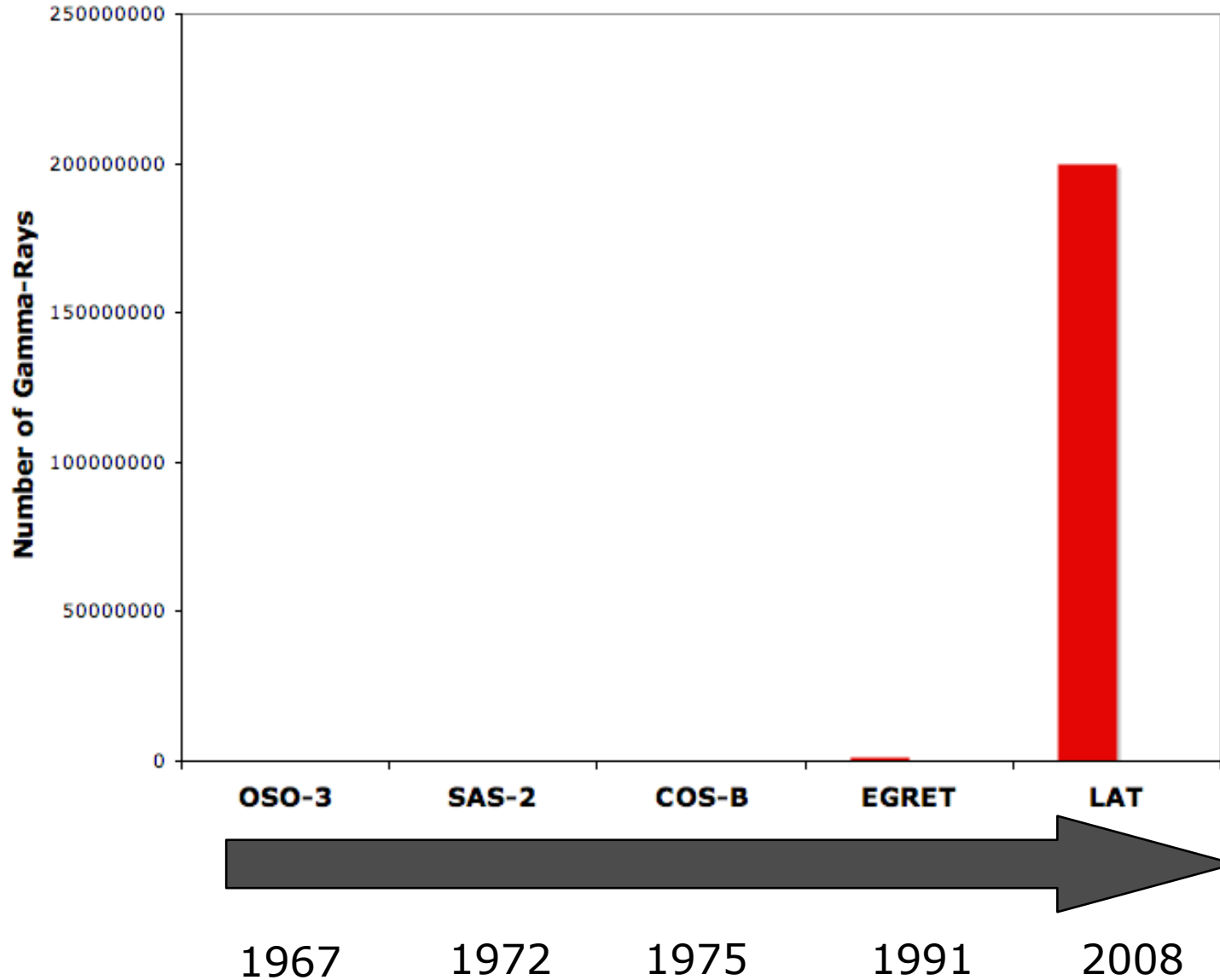

Now here  
1G events



# How many gammas?

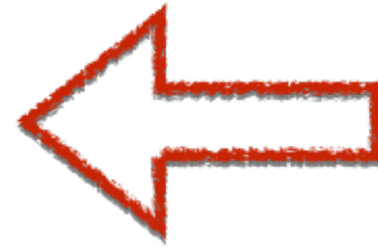
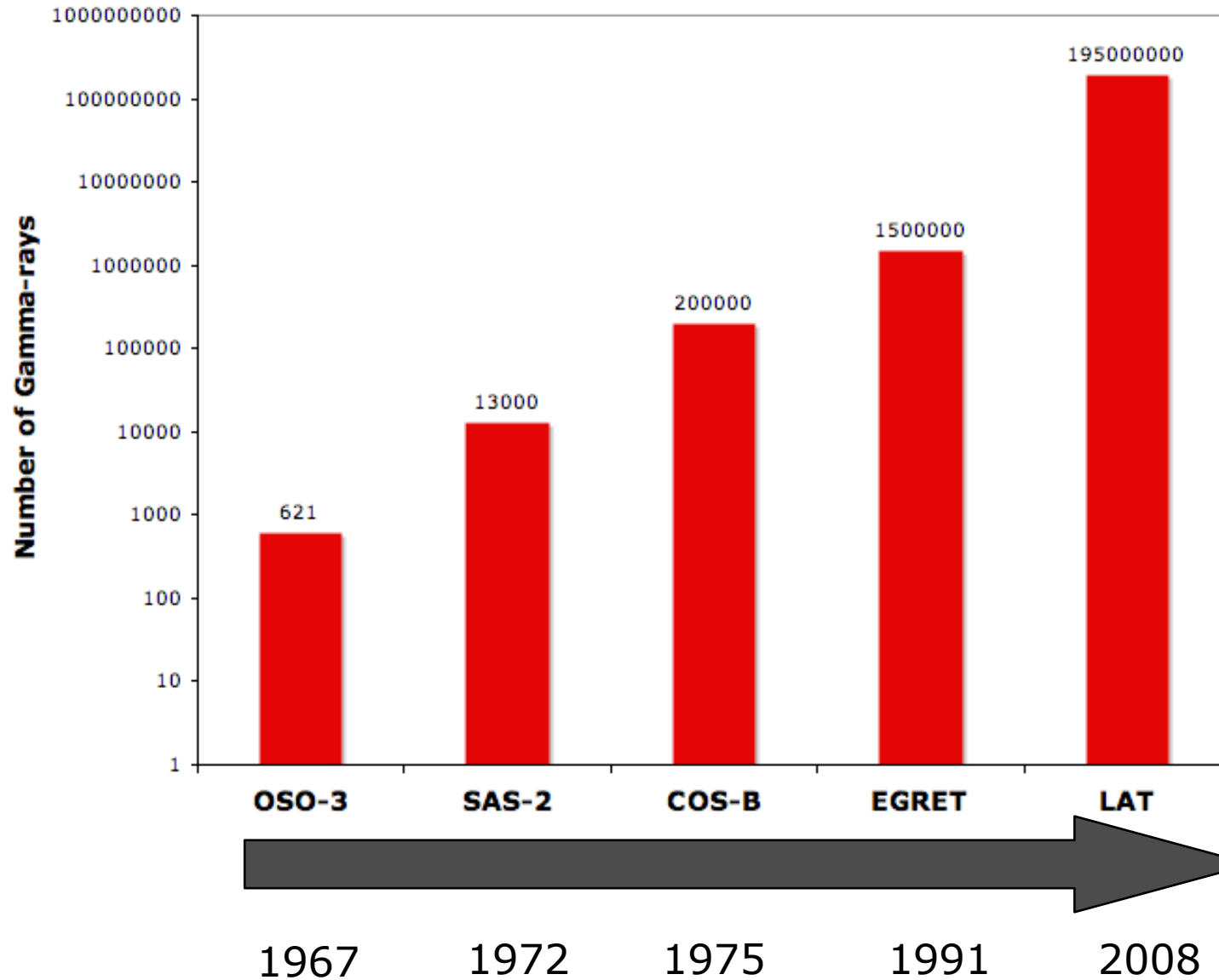

Now here  
1G events