

# Kubernetes



An Introduction

[Doina Cristina Duma](#), [Diego Ciangottini](#), [Daniele Spiga](#)

# Before we begin (about these slides)



These slides are forked and adapted (by Andrea Ceccanti) from

- <https://github.com/mrbobbytables/k8s-intro-tutorials>

Kudos to the authors!

**\$ whoami - Bob** 

**Bob Killen**  
[rkillen@umich.edu](mailto:rkillen@umich.edu)  
Senior Research Cloud Administrator  
CNCF Ambassador  
Github: [@mrbobbytables](#)  
Twitter: [@mrbobbytables](#)

  
  
CLOUD NATIVE  
COMPUTING FOUNDATION  
AMBASSADOR



**\$ whoami - Jeff** 

**Jeffrey Sica**  
[jeef111x@gmail.com](mailto:jeef111x@gmail.com)  
Senior Software Engineer @  Red Hat  
Github: [@jeefy](#)  
Twitter: [@jeefy](#)



# Before We Begin



## Requirements:



- **Access to your VM:**

See [Logistics info](#) here. Also be sure to know your VM IP address, referenced with **<your-vm-ip>**, we will use it during the hands on

- **k8s-intro-tutorials repo:**

- <https://github.com/caifti/k8s-intro-tutorials.git>
- Clone the repo with the following command:

```
$ git clone https://github.com/caifti/k8s-intro-tutorials.git
```

# Cloning the repo



```
tutor3@tutorvm-3: ~  
tutor3@tutorvm-3:~$ git clone https://github.com/caifti/k8s-intro-tutorials.git  
Cloning into 'k8s-intro-tutorials'...  
remote: Enumerating objects: 556, done.  
remote: Counting objects: 100% (202/202), done.  
remote: Compressing objects: 100% (183/183), done.  
remote: Total 556 (delta 99), reused 64 (delta 17), pack-reused 354  
Receiving objects: 100% (556/556), 614.60 KiB | 1.69 MiB/s, done.  
Resolving deltas: 100% (267/267), done.  
tutor3@tutorvm-3:~$ cd k8s-intro-tutorials/  
tutor3@tutorvm-3:~/k8s-intro-tutorials$ ls  
LICENSE README.md cli configuration core examples images olss storage workloads  
tutor3@tutorvm-3:~/k8s-intro-tutorials$ cd  
tutor3@tutorvm-3:~$ █
```

# OLSS demo app



<https://github.com/aceccanti/olss-demo-app>

Simple web service that will be used during the course to showcase K8S integration

A screenshot of a web browser displaying the GitHub repository page for 'olss-demo-app'. The browser's address bar shows the URL 'https://github.com/aceccanti/olss-demo-app'. The page content includes a 'README.md' file, a commit history table, and a 'Languages' section. The commit history shows a commit 'First import' from '14 months ago' and another 'Bumped version to 0.0.5' from '9 months ago'. The 'Languages' section shows a bar chart with the following data:

Language	Percentage
Java	86.2%
Dockerfile	9.9%
Shell	3.9%

The main content of the README includes the title 'OLSS demo application', a status 'Maven build & test passing', and two sections: 'Manual build instructions' and 'Manual docker build instructions'. The 'Manual build instructions' section contains the command: 

```
./mvnw package
```

The 'Manual docker build instructions' section contains the commands: 

```
./mvnw package  
docker build --file docker/Dockerfile -t olss-demo-app .
```



# Project Overview

# What Does “Kubernetes” Mean?



Greek for “pilot” or  
“Helmsman of a ship”

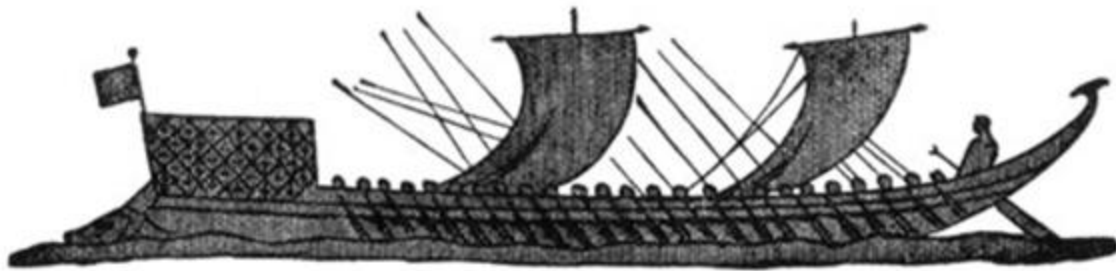

[Image Source](#)



# What Does Kubernetes do?



- Known as the **linux kernel of distributed systems**.
- **Abstracts away the underlying hardware** of the nodes and provides a uniform interface for workloads to be both deployed and consume the shared pool of resources.
- Works as an engine for resolving state by converging actual and the **desired state** of the system.



# What is Kubernetes?



- Project that was spun out of Google as an open source container orchestration platform.
- Built from the lessons learned in the experiences of developing and running Google's Borg and Omega.
- Designed from the ground-up as a **loosely coupled** collection of components centered around deploying, maintaining and scaling workloads.

# Decouples Infrastructure and Scaling



- **All services** within Kubernetes are natively Load Balanced.
- Can scale up and down dynamically.
- Used both to enable self-healing and seamless upgrading or rollback of applications.

# Self Healing



Kubernetes will **ALWAYS** try and steer the cluster to its desired state.

- **Me:** “I want 3 healthy instances of redis to always be running.”
- **Kubernetes:** “Okay, I’ll ensure there are always 3 instances up and running.”
- **Kubernetes:** “Oh look, one has died. I’m going to attempt to spin up a new one.”

# What can Kubernetes REALLY do?



- Autoscale Workloads
- Blue/Green Deployments
- Fire off jobs and scheduled cronjobs
- Manage Stateless and Stateful Applications
- Provide native methods of service discovery
- Easily integrate and support 3rd party apps

# Most Importantly...



Use the **SAME** API  
across bare metal and  
**EVERY** cloud provider!!!



# Who “Manages” Kubernetes?



**CLOUD NATIVE  
COMPUTING FOUNDATION**

The CNCF is a child entity of the Linux Foundation and operates as a vendor neutral governance group.

# Project Stats



- Over 76,000 stars on [Github](#)
- 2000+ Contributors to K8s Core
- Most discussed Repository by a large margin
- **70,000+** users in Slack Team



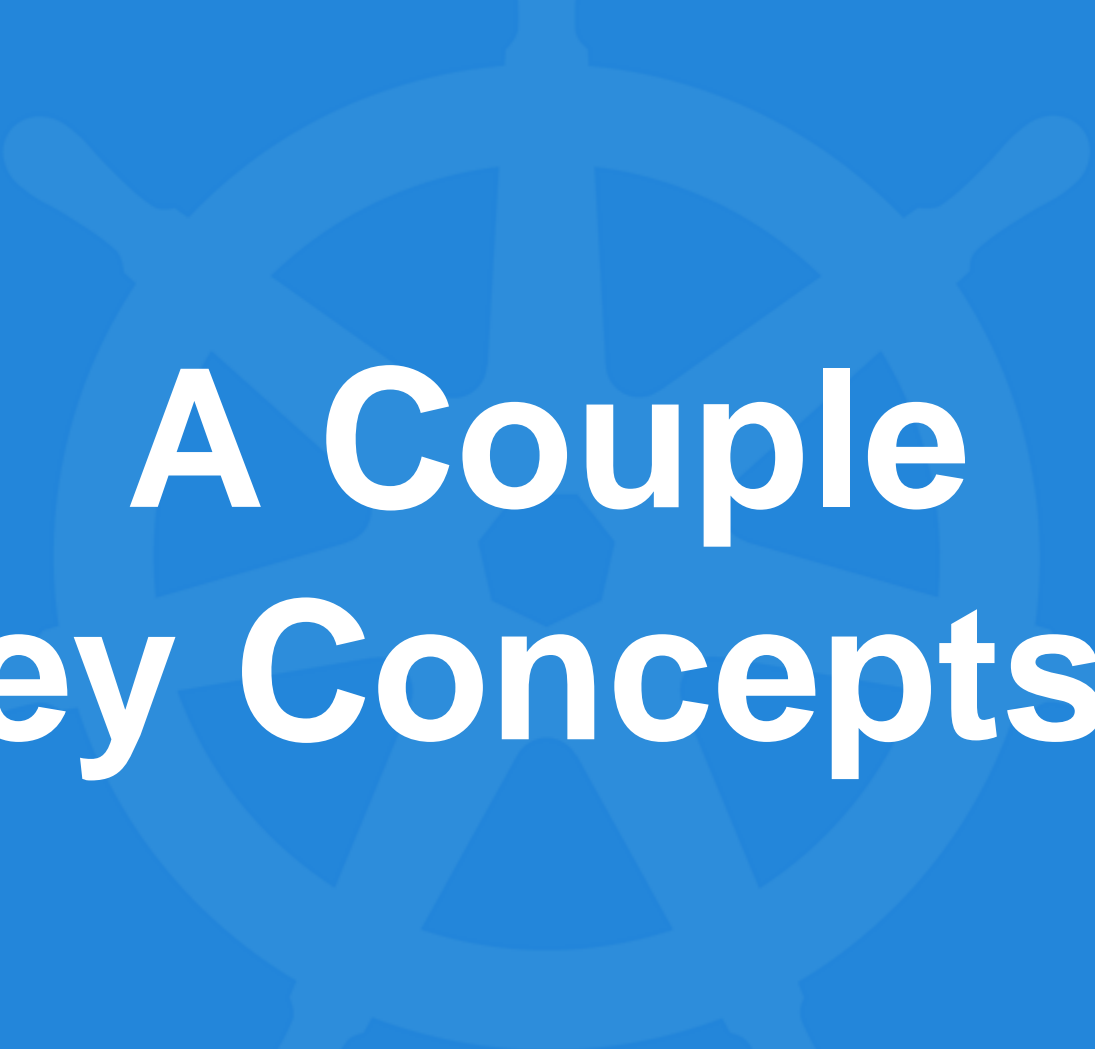

# A Couple Key Concepts...



# Pods



- **Atomic unit** or smallest “*unit of work*” of Kubernetes.
- Pods are **one or MORE containers** that share volumes, a network namespace, and are a part of a **single context**.

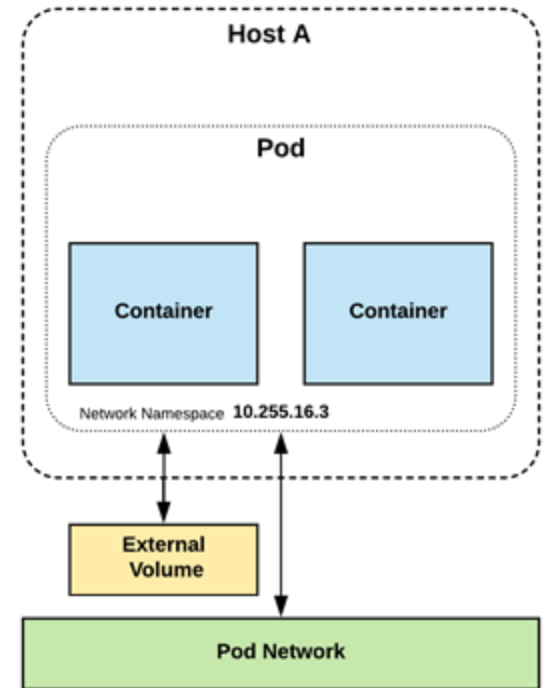

# Pods



**They are  
also  
Ephemeral!**

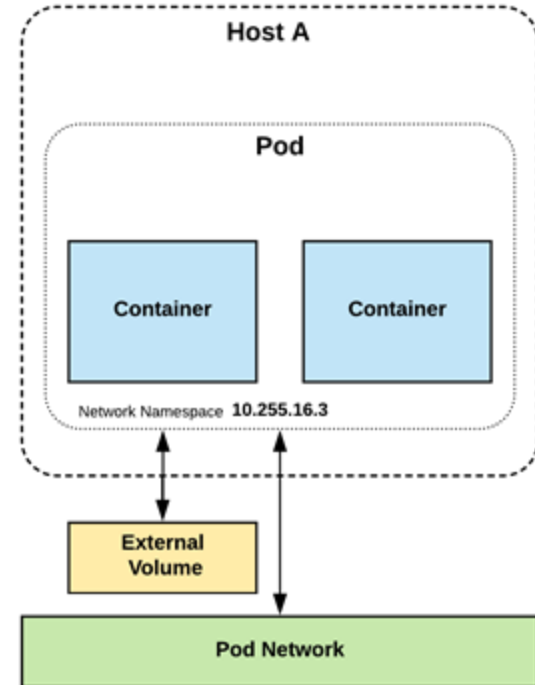

# Services



- **Unified method of accessing** the exposed workloads of Pods.
- **Durable resource**
  - static cluster IP
  - static namespaced DNS name

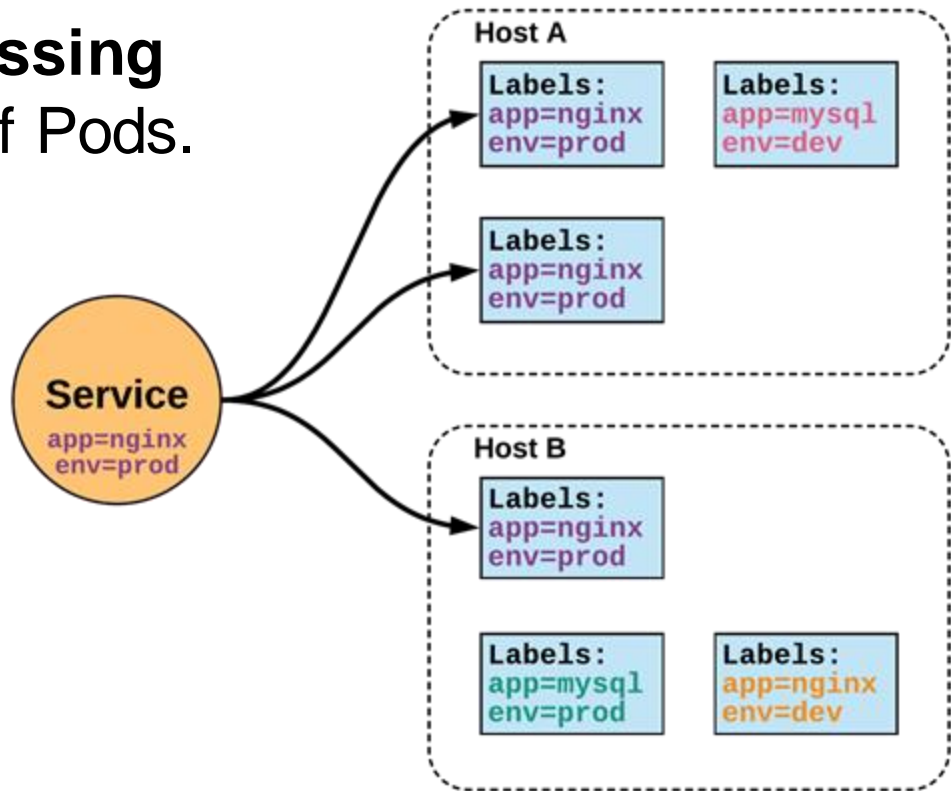



# Services

- **Unified method of accessing** the exposed workloads of Pods.
- **Durable resource**
  - static cluster IP
  - static namespaced DNS name

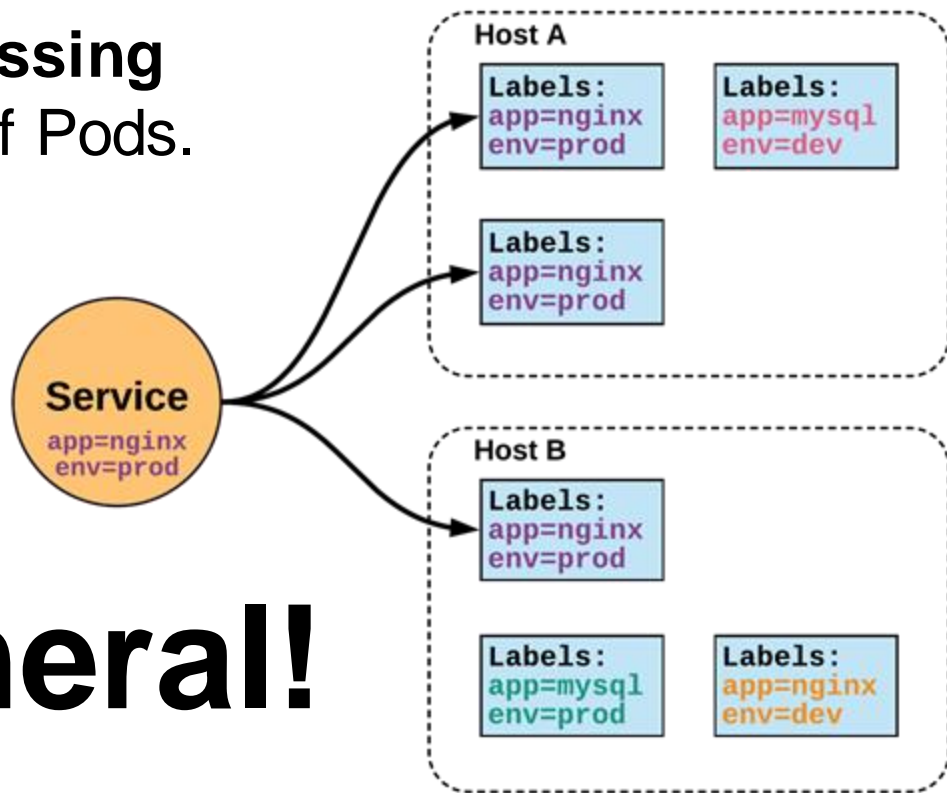

# NOT Ephemeral!



# Architecture Overview

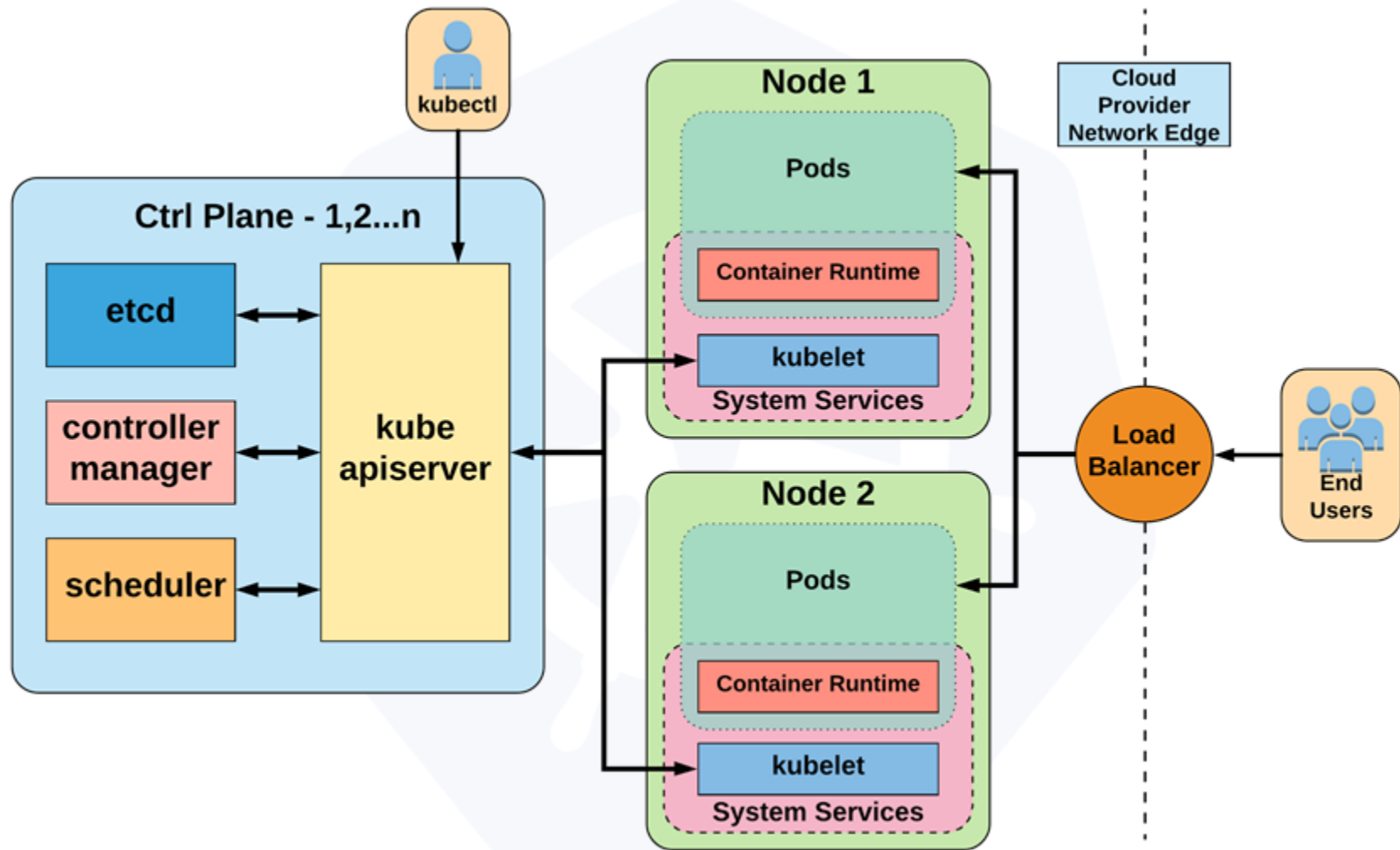

# Control Plane Components



Architecture Overview

# Control Plane Components



- kube-apiserver
- etcd
- kube-controller-manager
- kube-scheduler

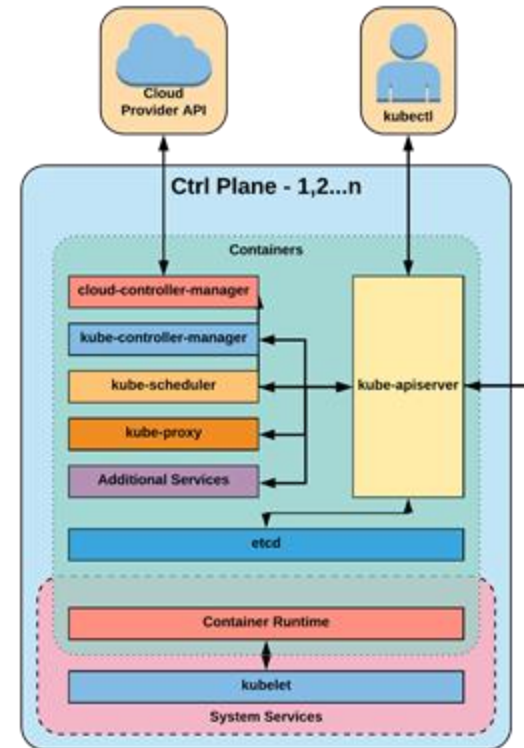



# kube-apiserver



- Provides a forward facing REST interface into the kubernetes control plane and datastore.
- All clients and other applications interact with kubernetes **strictly** through the API Server.
- Acts as the gatekeeper to the cluster by handling authentication and authorization, request validation, mutation, and admission control in addition to being the front-end to the backing datastore.

# etcd



- etcd acts as the cluster datastore.
- Purpose in relation to Kubernetes is to provide a strong, consistent and highly available key-value store for persisting cluster state.
- Stores objects and config information.



# etcd



Uses “*Raft Consensus*” among a quorum of systems to create a fault-tolerant consistent “*view*” of the cluster.

<https://raft.github.io/>

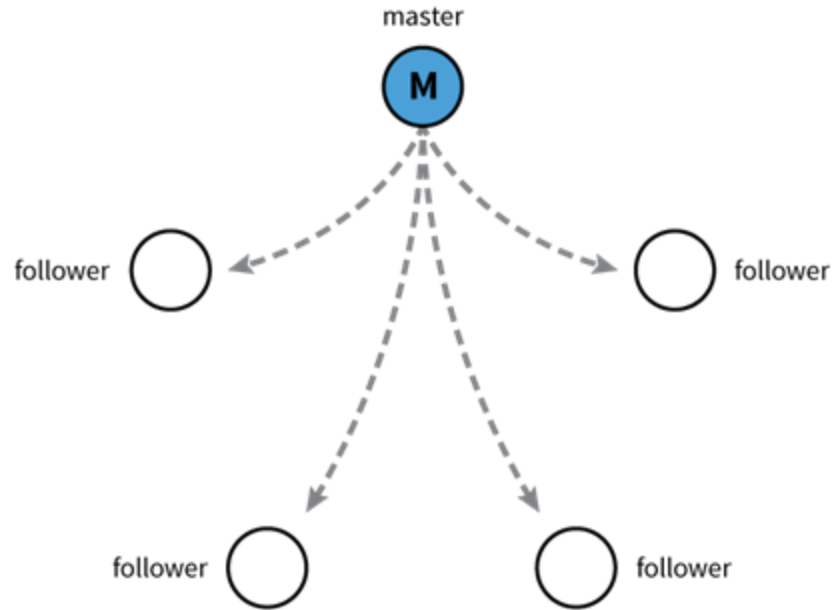

[Image Source](#)

# kube-controller-manager



- Serves as the primary daemon that manages all core component control loops.
- Monitors the cluster state via the apiserver and **steers the cluster towards the desired state.**

List of core controllers: <https://github.com/kubernetes/kubernetes/blob/master/cmd/kube-controller-manager/app/controllermanager.go#L344>

# kube-scheduler



- Verbose policy-rich engine that evaluates workload requirements and attempts to place it on a matching resource.
- Default scheduler uses bin packing.
- Workload Requirements can include: general hardware requirements, affinity/anti-affinity, labels, and other various custom resource requirements.

The background of the slide features a large, semi-transparent watermark of the Node.js logo, which is a ship's steering wheel, positioned on the right side.

# Node Components

Architecture Overview

# Node Components



- kubelet
- kube-proxy
- Container Runtime Engine

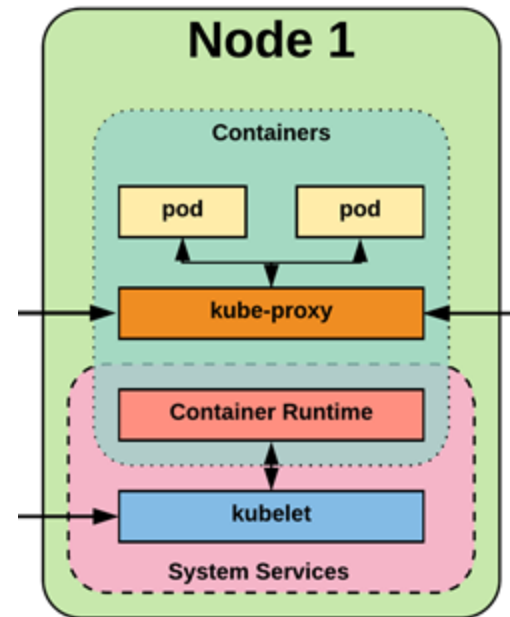

# kubelet



- Acts as the node agent responsible for managing the lifecycle of every pod on its host.
- Kubelet understands YAML container manifests that it can read from several sources:
  - file path
  - HTTP Endpoint
  - etcd watch acting on any changes
  - HTTP Server mode accepting container manifests over a simple API.



# kube-proxy



- Manages the network rules on each node.
- Performs connection forwarding or load balancing for Kubernetes cluster services.
- Available Proxy Modes:
  - Userspace
  - iptables
  - ipvs (default if supported)

# Container Runtime Engine



- A container runtime is a CRI (Container Runtime Interface) compatible application that executes and manages containers.
  - Containerd (docker)
  - Cri-o
  - Rkt
  - Kata (formerly clear and hyper)
  - Virtlet (VM CRI compatible runtime)

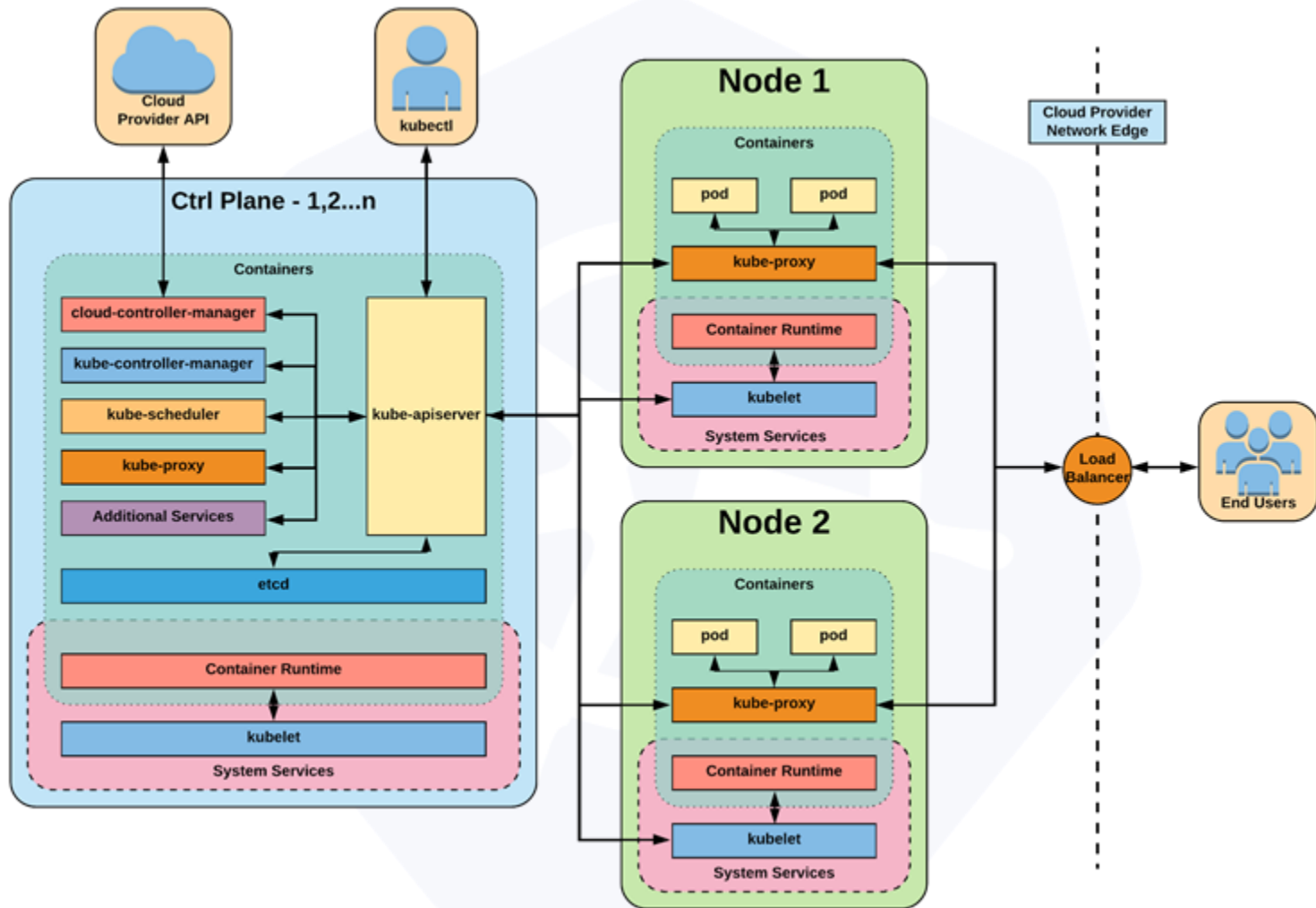



# Optional Services

Architecture Overview

# cloud-controller-manager



- Daemon that provides cloud-provider specific knowledge and integration capability into the core control loop of Kubernetes.
- The controllers include Node, Route, Service, and add an additional controller to handle things such as **PersistentVolume** Labels.

# Cluster DNS



- Provides Cluster Wide DNS for Kubernetes Services.
  - Built on top of CoreDNS

# Kube Dashboard



A limited, general purpose web front end for the Kubernetes Cluster.

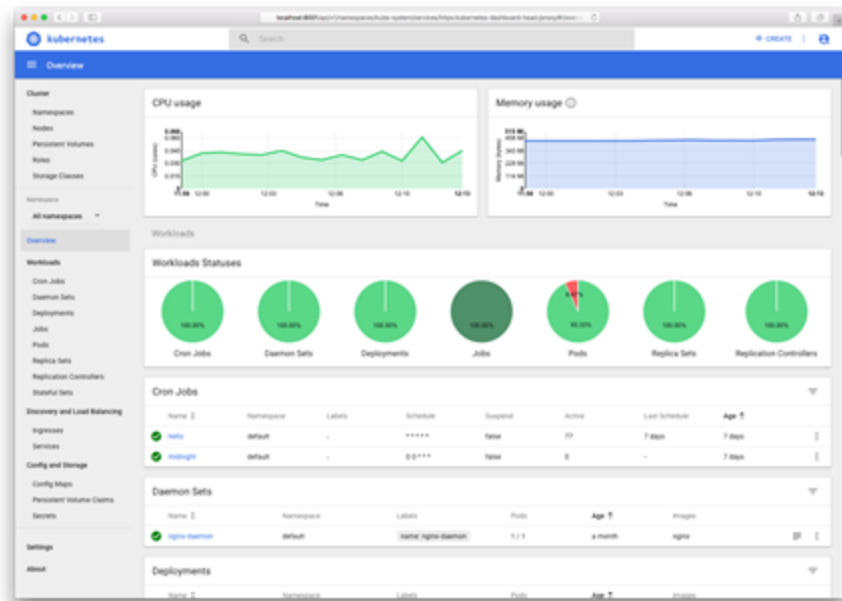

# Heapster / Metrics API Server



- Provides metrics for use with other Kubernetes Components.
  - Heapster (deprecated, removed last Dec)
  - Metrics API (current)



# Networking



## Architecture Overview

# Kubernetes Networking



- **Pod Network**

- Cluster-wide network used for pod-to-pod communication managed by a CNI (Container Network Interface) plugin.

- **Service Network**

- Cluster-wide range of **Virtual IPs** managed by **kube-proxy** for service discovery.

# Container Network Interface (CNI)



- Pod networking within Kubernetes is plumbed via the [Container Network Interface](#) (CNI).
- Functions as an interface between the container runtime and a **network implementation plugin**.
- [CNCF Project](#)
- Uses a simple JSON Schema.



CNI

# CNI Overview

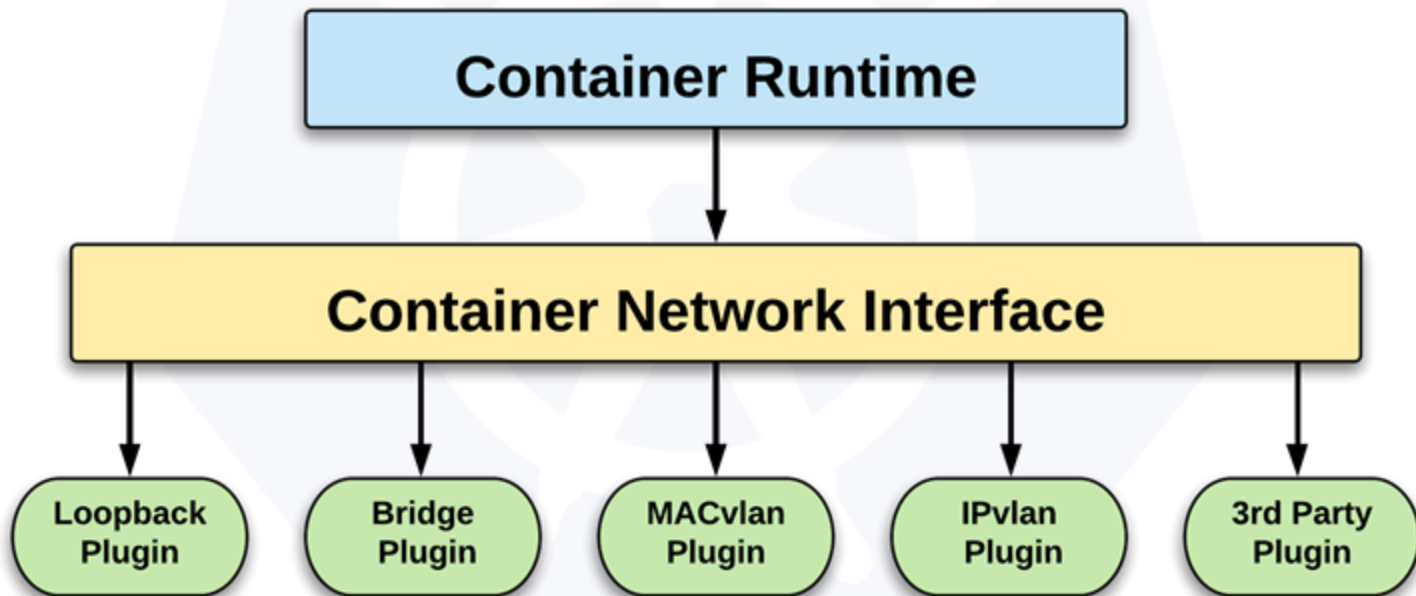

# CNI Plugins



- Amazon ECS
- Calico
- Cilium
- Contiv
- Contrail
- Flannel



- GCE
- kube-router
- Multus
- OpenVSwitch
- Romana
- Weave



# Fundamental Networking Rules



- All containers within a pod can communicate with each other unimpeded.
- All Pods can communicate with all other Pods without NAT.
- All nodes can communicate with all Pods (and vice-versa) without NAT.
- The IP that a Pod sees itself as is the same IP that others see it as.

# Fundamentals Applied



- **Container-to-Container**

- Containers within a pod exist within the **same network namespace** and share an IP.
- Enables intrapod communication over *localhost*.

- **Pod-to-Pod**

- Allocated **cluster unique IP** for the duration of its life cycle.
- Pods themselves are fundamentally ephemeral.

# Fundamentals Applied



- **Pod-to-Service**

- managed by **kube-proxy** and given a **persistent cluster unique IP**
- exists beyond a Pod's lifecycle.

- **External-to-Service**

- Handled by **kube-proxy**.
- Works in cooperation with a cloud provider or other external entity (load balancer).





# Concepts and Resources

# The API and Object Model

Concepts and Resources

# API Overview



- The **REST API** is the true **keystone** of Kubernetes.
- **Everything** within the Kubernetes is as an **API Object**.

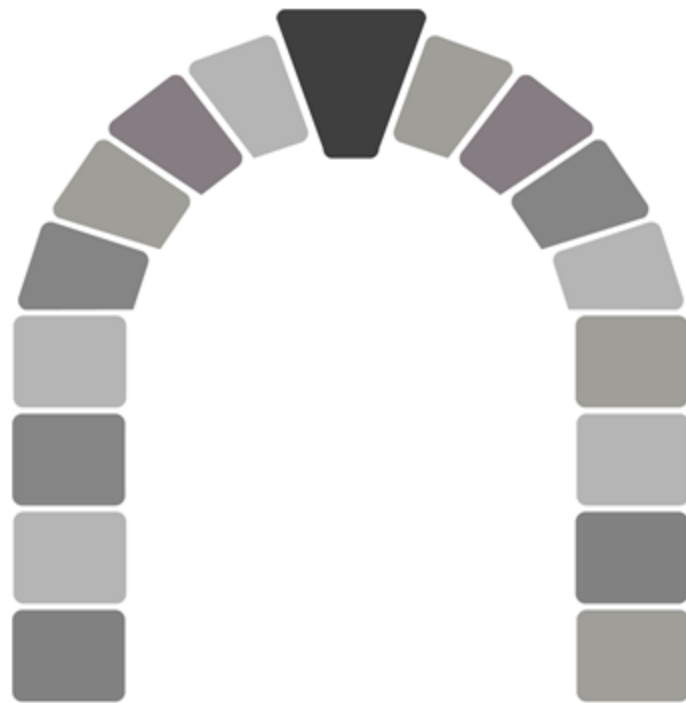

# API Groups



- Designed to make it extremely simple to both understand and extend.
- An API Group is a **REST compatible path** that acts as the type descriptor for a Kubernetes object.
- Referenced within an object as the `apiVersion` and `kind`.

## Format:

```
/apis/<group>/<version>/<resource>
```

## Examples:

```
/apis/apps/v1/deployments
```

```
/apis/batch/v1beta1/cronjobs
```

# API Versioning



- Three tiers of API maturity levels.
- Also referenced within the object `apiVersion`.

Format:

```
/apis/<group>/<version>/<resource>
```

Examples:

```
/apis/apps/v1/deployments
```

```
/apis/batch/v1beta1/cronjobs
```

- **Alpha:** Possibly buggy, And may change. **Disabled by default.**
- **Beta:** Tested and considered stable. However API Schema may change. **Enabled by default.**
- **Stable:** Released, stable and API schema will not change. **Enabled by default.**

# Object Model



- Objects are a “*record of intent*” or a persistent entity that represent the desired state of the object within the cluster.
- All objects **MUST** have `apiVersion`, `kind`, and possess the nested fields `metadata.name`, `metadata.namespace`, and `metadata.uid`.

# Object Model Requirements



- `apiVersion`: Kubernetes API version of the Object
- `kind`: Type of Kubernetes Object
- `metadata.name`: Unique name of the Object
- `metadata.namespace`: Scoped environment name that the object belongs to (will default to current).
- `metadata.uid`: The (generated) uid for an object.

```
apiVersion: v1
kind: Pod
metadata:
  name: pod-example
  namespace: default
  uid: f8798d82-1185-11e8-94ce-080027b3c7a6
```

# Object Expression - YAML



- Files or other representations of Kubernetes Objects are generally represented in YAML.
- A “*Human Friendly*” data serialization standard.
- Uses white space (specifically spaces) alignment to denote ownership.
- Three basic data types:
  - **mappings** - hash or dictionary,
  - **sequences** - array or list
  - **scalars** - string, number, boolean etc



# Object Expression - YAML



```
apiVersion: v1
kind: Pod
metadata:
  name: yaml
spec:
  containers:
    - name: container1
      image: nginx
    - name: container2
      image: alpine
```

# Object Expression - YAML

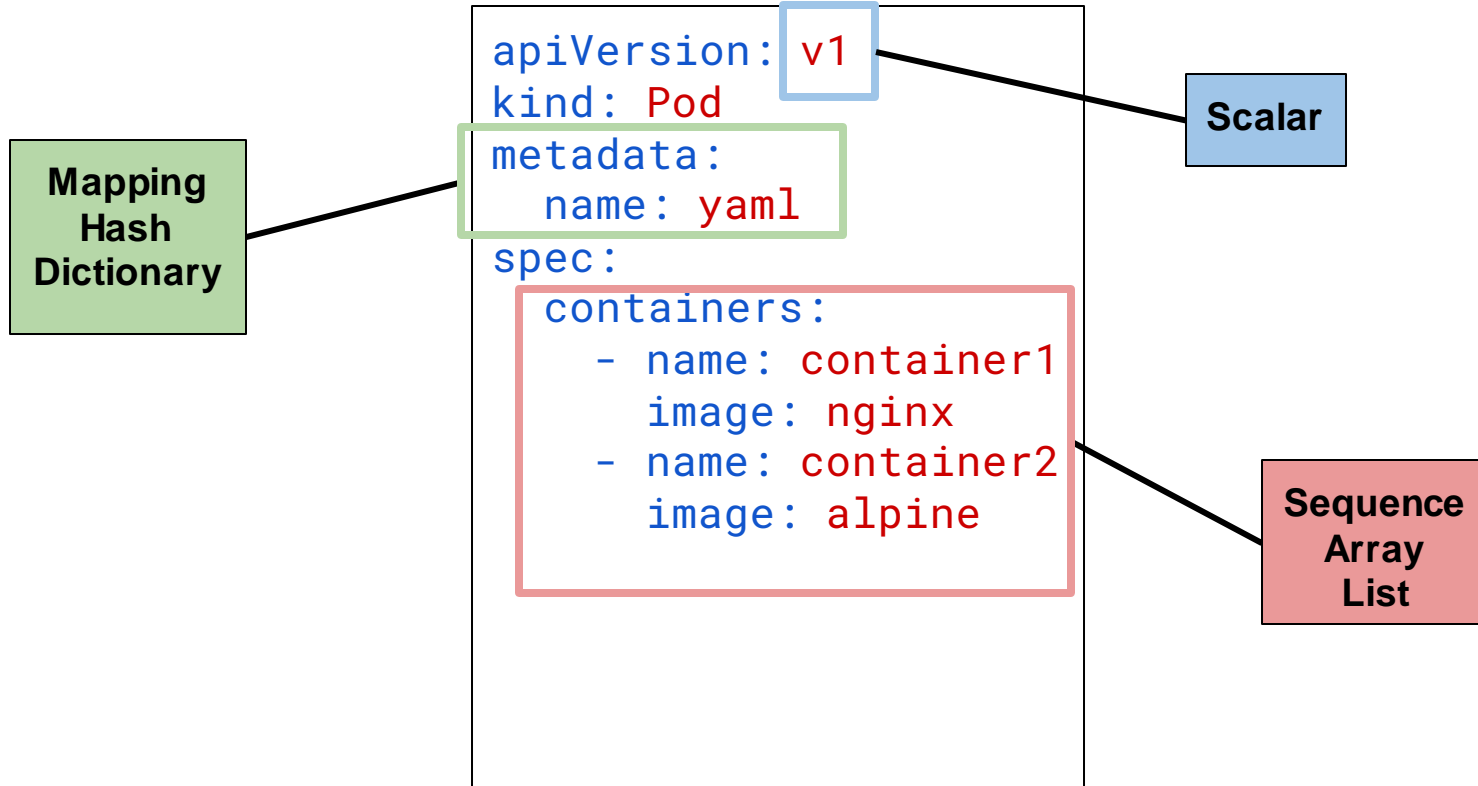

# YAML vs JSON



```
apiVersion: v1
kind: Pod
metadata:
  name: pod-example
spec:
  containers:
  - name: nginx
    image: nginx:stable-alpine
    ports:
    - containerPort: 80
```

```
{
  "apiVersion": "v1",
  "kind": "Pod",
  "metadata": {
    "name": "pod-example"
  },
  "spec": {
    "containers": [
      {
        "name": "nginx",
        "image": "nginx:stable-alpine",
        "ports": [ { "containerPort": 80 } ]
      }
    ]
  }
}
```

# Object Model - Workloads



- Workload related objects within Kubernetes have an additional two nested fields `spec` and `status`.
  - `spec` - Describes the **desired state** or **configuration** of the object to be created.
  - `status` - Is managed by Kubernetes and describes the **actual state** of the object and its history.

# Workload Object Example



## Example Object

```
apiVersion: v1
kind: Pod
metadata:
  name: pod-example
spec:
  containers:
  - name: nginx
    image: nginx:stable-alpine
    ports:
    - containerPort: 80
```

## Example Status Snippet

```
status:
  conditions:
  - lastProbeTime: null
    lastTransitionTime: 2018-02-14T14:15:52Z
    status: "True"
    type: Ready
  - lastProbeTime: null
    lastTransitionTime: 2018-02-14T14:15:49Z
    status: "True"
    type: Initialized
  - lastProbeTime: null
    lastTransitionTime: 2018-02-14T14:15:49Z
    status: "True"
    type: PodScheduled
```

# Hands-on: using the CLI



<https://github.com/caifti/k8s-intro-tutorials/tree/master/cli>

# Core Objects

- Namespaces
- Pods
- Labels
- Selectors
- Services

# Core Concepts



Kubernetes has several core building blocks that make up the foundation of their higher level components.

## **Namespaces**

**Pods**  
**Labels**

**Services**  
**Selectors**



# Namespaces



Namespaces are a logical cluster or environment, and are the primary method of partitioning a cluster or scoping access.

```
apiVersion: v1
kind: Namespace
metadata:
  name: prod
  labels:
    app: MyBigWebApp
```

```
$ kubectl get ns --show-labels
NAME          STATUS    AGE      LABELS
default       Active   11h      <none>
kube-public   Active   11h      <none>
kube-system   Active   11h      <none>
prod          Active    6s      app=MyBigWebApp
```

# Default Namespaces



- **default**: The default namespace for any object without a namespace.
- **kube-system**: Acts as the home for objects and resources created by Kubernetes itself.
- **kube-public**: A special namespace; readable by all users that is reserved for cluster bootstrapping and configuration.

```
$ kubectl get ns --show-labels
NAME           STATUS   AGE   LABELS
default        Active   11h   <none>
kube-public    Active   11h   <none>
kube-system    Active   11h   <none>
```

# Pod



- **Atomic unit** or smallest “*unit of work*” of Kubernetes.
- Foundational building block of Kubernetes Workloads.
- Pods are one or more containers that share volumes, a network namespace, and are a part of a **single context**.

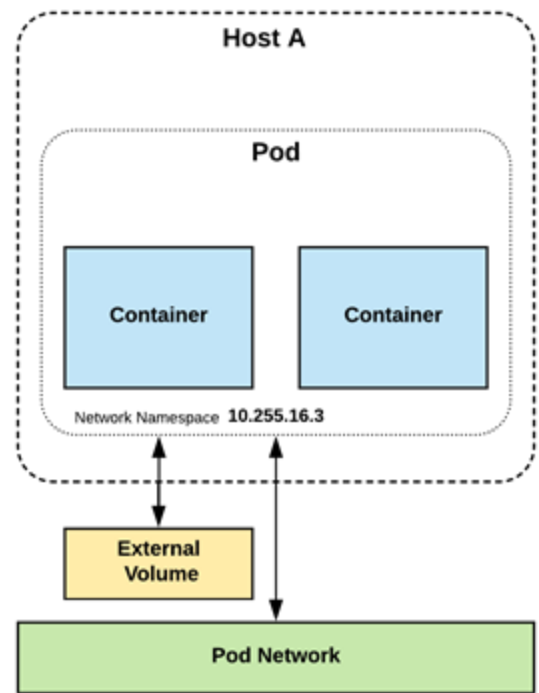

# Pod Examples



```
apiVersion: v1
kind: Pod
metadata:
  name: pod-example
spec:
  containers:
  - name: nginx
    image: nginx:stable-alpine
    ports:
    - containerPort: 80
```

```
apiVersion: v1
kind: Pod
metadata:
  name: multi-container-example
spec:
  containers:
  - name: nginx
    image: nginx:stable-alpine
    ports:
    - containerPort: 80
    volumeMounts:
    - name: html
      mountPath: /usr/share/nginx/html
  - name: content
    image: alpine:latest
    command: ["/bin/sh", "-c"]
    args:
    - while true; do
      date >> /html/index.html;
      sleep 5;
    done
    volumeMounts:
    - name: html
      mountPath: /html
  volumes:
  - name: html
    emptyDir: {}
```

# Key Pod Container Attributes



- `name` - The name of the container
- `image` - The container image
- `ports` - array of ports to expose. Can be granted a friendly name and protocol may be specified
- `env` - array of environment variables
- `command` - Entrypoint array (equiv to Docker `ENTRYPOINT`)
- `args` - Arguments to pass to the command (equiv to Docker `CMD`)

## Container

```
name: nginx
image: nginx:stable-alpine
ports:
  - containerPort: 80
    name: http
    protocol: TCP
env:
  - name: MYVAR
    value: isAwesome
command: ["/bin/sh", "-c"]
args: ["echo ${MYVAR}"]
```

# Labels



- key-value pairs that are used to identify, describe and group together related sets of objects or resources.
- **NOT** characteristic of uniqueness.
- Have a strict syntax with a slightly limited character set\*.

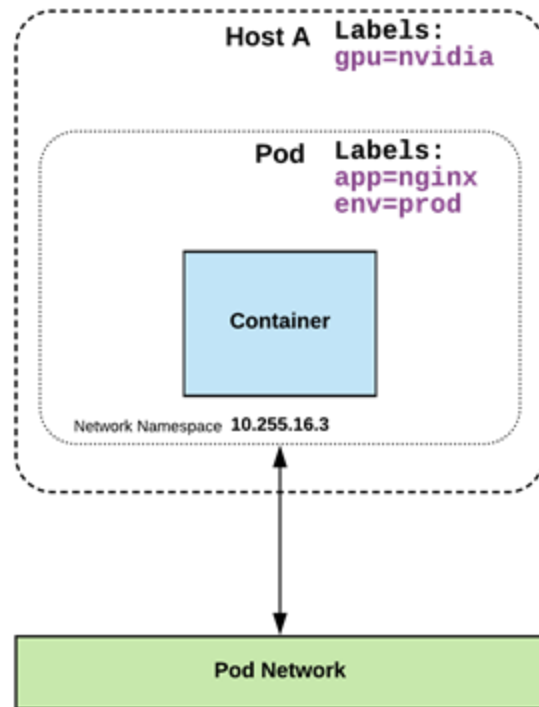

\* <https://kubernetes.io/docs/concepts/overview/working-with-objects/labels/#syntax-and-character-set>

# Label Example



```
apiVersion: v1
kind: Pod
metadata:
  name: pod-label-example
  labels:
    app: nginx
    env: prod
spec:
  containers:
  - name: nginx
    image: nginx:stable-alpine
    ports:
    - containerPort: 80
```

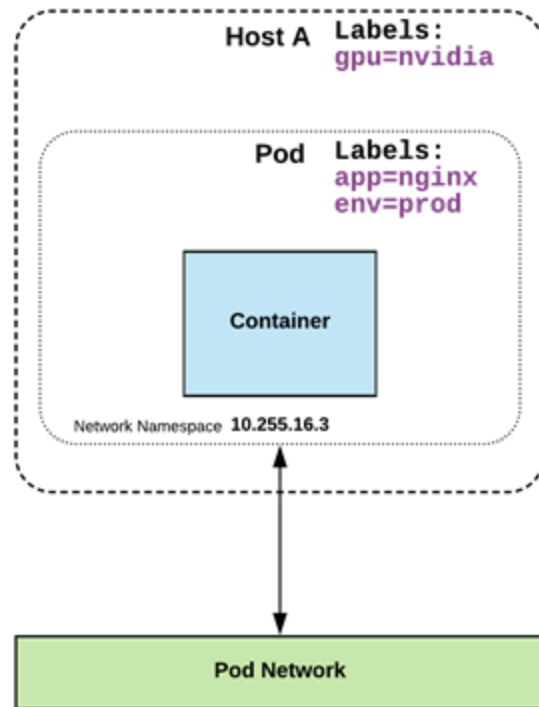

# Selectors



Selectors use labels to filter or select objects, and are used throughout Kubernetes.

```
apiVersion: v1
kind: Pod
metadata:
  name: pod-label-example
  labels:
    app: nginx
    env: prod
spec:
  containers:
  - name: nginx
    image: nginx:stable-alpine
    ports:
    - containerPort: 80
  nodeSelector:
    gpu: nvidia
```



# Selector Example

```
apiVersion: v1
kind: Pod
metadata:
  name: pod-label-example
  labels:
    app: nginx
    env: prod
spec:
  containers:
  - name: nginx
    image: nginx:stable-alpine
    ports:
    - containerPort: 80
  nodeSelector:
    gpu: nvidia
```

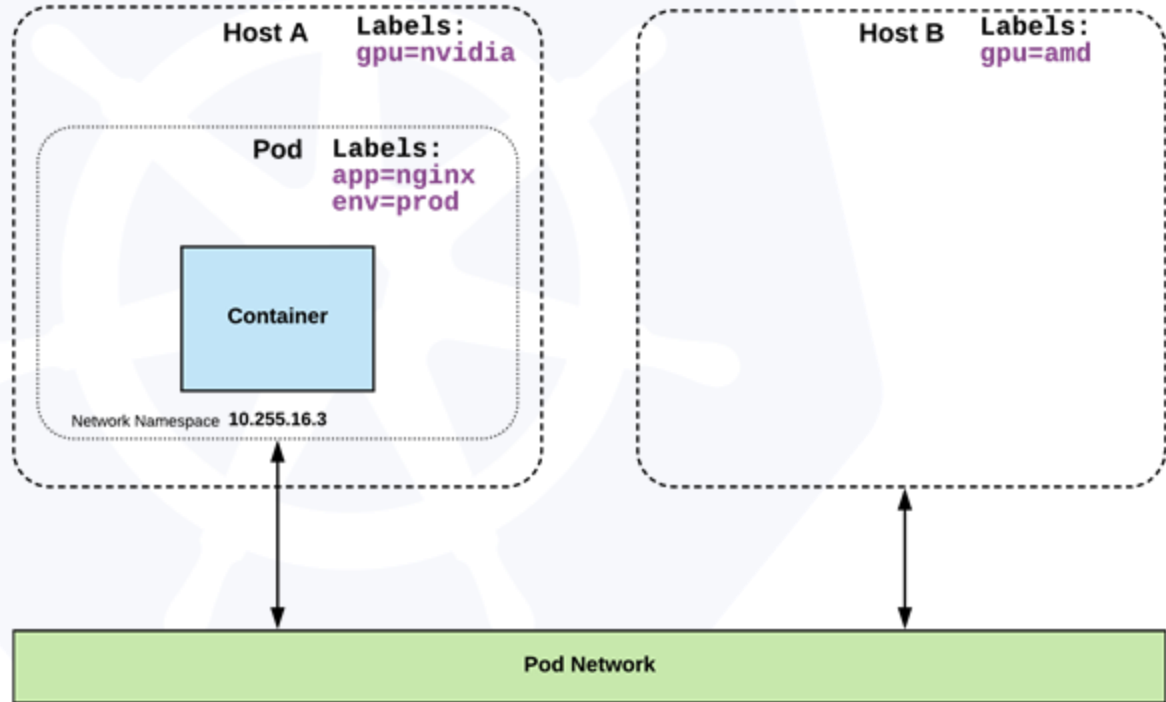

# Selector Types



**Equality based** selectors allow for simple filtering (=, ==, or !=).

```
selector:  
  matchLabels:  
    gpu: nvidia
```

**Set-based** selectors are supported on a limited subset of objects. However, they provide a method of filtering on a set of values, and supports multiple operators including: **in**, **notin**, and **exist**.

```
selector:  
  matchExpressions:  
    - key: gpu  
      operator: in  
      values: ["nvidia"]
```

# Services



- **Unified method of accessing** the exposed workloads of Pods.
- **Durable resource** (unlike Pods)
  - static cluster-unique IP
  - static namespaced DNS name

**<service name>.<namespace>.svc.cluster.local**

# Services



- Target Pods using **equality based selectors**.
- Uses **kube-proxy** to provide simple load-balancing.
- **kube-proxy** acts as a daemon that creates **local entries** in the host's iptables for every service.

# Service Types



There are 4 major service types:

- **ClusterIP** (default)
- **NodePort**
- **LoadBalancer**
- **ExternalName**

# ClusterIP Service



**ClusterIP** services exposes a service on a strictly cluster internal virtual IP.

```
apiVersion: v1
kind: Service
metadata:
  name: example-prod
spec:
  selector:
    app: nginx
    env: prod
  ports:
    - protocol: TCP
      port: 80
      targetPort: 80
```

# Cluster IP Service

```
Name:          example-prod
Selector:      app=nginx,env=prod
Type:         ClusterIP
IP:           10.96.28.176
Port:         <unset> 80/TCP
TargetPort:   80/TCP
Endpoints:    10.255.16.3:80,
              10.255.16.4:80
```

```
/ # nslookup example-prod.default.svc.cluster.local
Name:      example-prod.default.svc.cluster.local
Address 1: 10.96.28.176 example-prod.default.svc.cluster.local
```

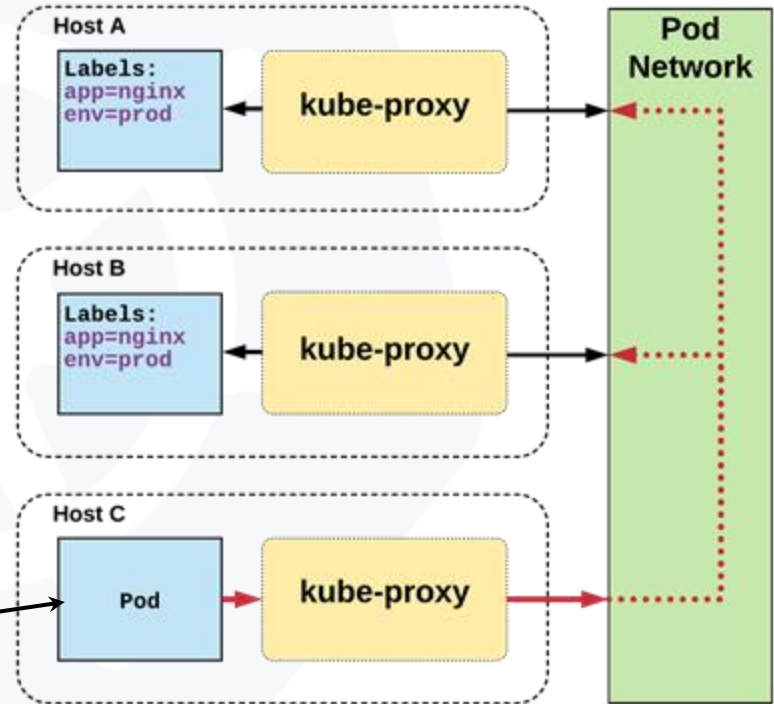

# NodePort Service



- **NodePort** services extend the **ClusterIP** service.
- Exposes a port on every node's IP.
- Port can either be statically defined, or dynamically taken from a range between 30000-32767.

```
apiVersion: v1
kind: Service
metadata:
  name: example-prod
spec:
  type: NodePort
  selector:
    app: nginx
    env: prod
  ports:
    - nodePort: 32410
      protocol: TCP
      port: 80
      targetPort: 80
```



# NodePort Service

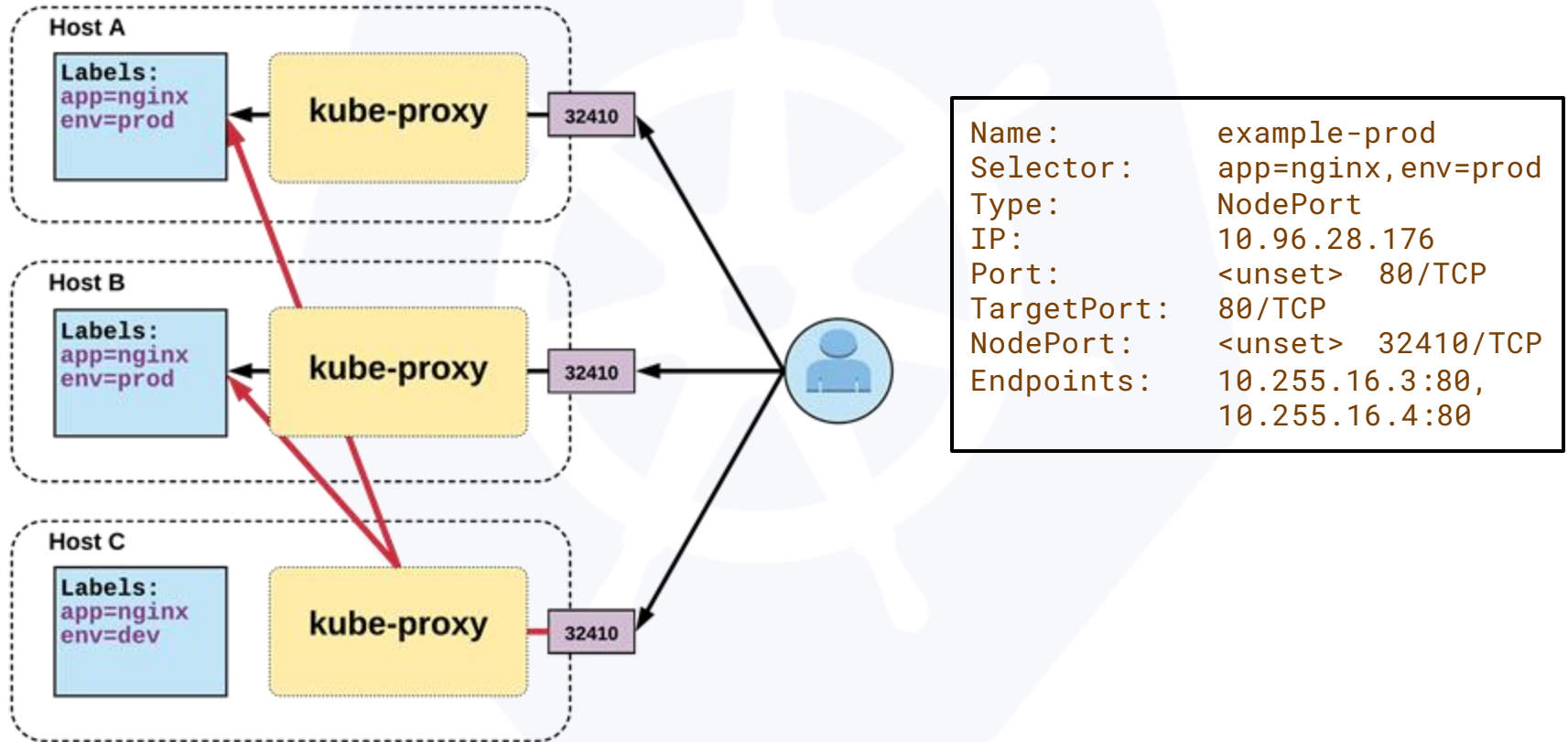

# LoadBalancer Service



- **LoadBalancer** services extend **NodePort**.
- Works in conjunction with an external system to map a cluster external IP to the exposed service.

```
apiVersion: v1
kind: Service
metadata:
  name: example-prod
spec:
  type: LoadBalancer
  selector:
    app: nginx
    env: prod
  ports:
    protocol: TCP
    port: 80
    targetPort: 80
```

# LoadBalancer Service

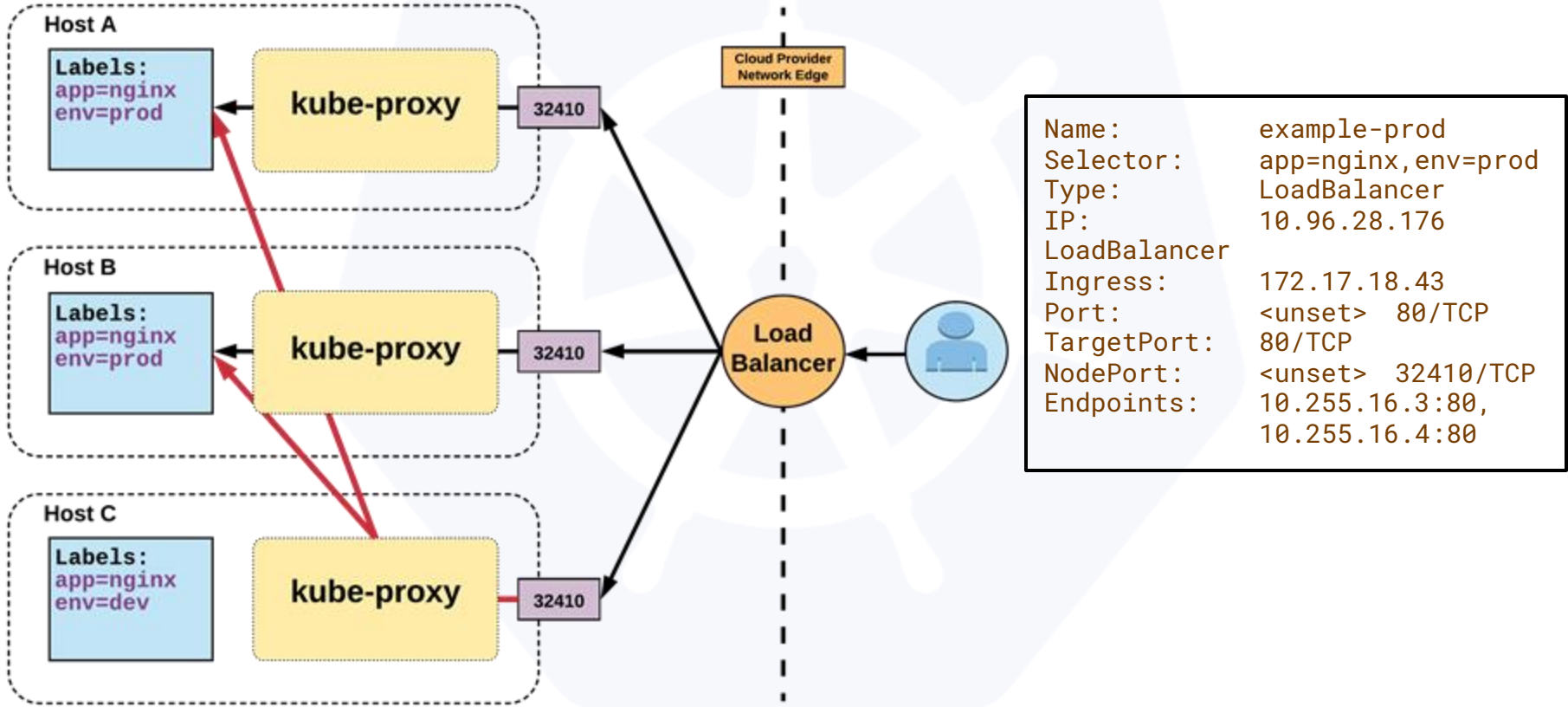

# ExternalName Service



- **ExternalName** is used to reference endpoints **OUTSIDE** the cluster.
- Creates an internal **CNAME** DNS entry that aliases another.

```
apiVersion: v1
kind: Service
metadata:
  name: example-prod
spec:
  type: ExternalName
spec:
  externalName: example.com
```

# Ingress – Name Based Routing



- An API object that manages external access to the services in a cluster
- Provides load balancing, SSL termination and name/path-based virtual hosting
- Gives services externally-reachable URLs

```
apiVersion: extensions/v1beta1
kind: Ingress
metadata:
  name: name-virtual-host-ingress
spec:
  rules:
  - host: first.bar.com
    http:
      paths:
      - backend:
          serviceName: service1
          servicePort: 80
  - host: second.foo.com
    http:
      paths:
      - backend:
          serviceName: service2
          servicePort: 80
  - http:
      paths:
      - backend:
          serviceName: service3
          servicePort: 80
```

# Ingress – Path Based Routing



```
apiVersion: extensions/v1beta1
kind: Ingress
metadata:
  name: simple-fanout-example
spec:
  rules:
  - host: foo.bar.com
    http:
      paths:
      - path: /foo
        backend:
          serviceName: service1
          servicePort: 4200
      - path: /bar
        backend:
          serviceName: service2
          servicePort: 8080
```

# Hands-on: Services



<https://github.com/caifti/k8s-intro-tutorials/blob/master/core>

# Workloads

- **ReplicaSet**
- **Deployment**
- **DaemonSet**
- **StatefulSet**
- **Job**
- **CronJob**



# Workloads



Workloads within Kubernetes are higher level objects that manage Pods or other higher level objects.

In **ALL CASES** a Pod Template is included, and acts the base tier of management.

# Pod Template



- Workload Controllers manage instances of Pods based on a provided template.
- Pod Templates are Pod specs with limited metadata.
- Controllers use Pod Templates to make actual pods.

```
apiVersion: v1
kind: Pod
metadata:
  name: pod-example
  labels:
    app: nginx
spec:
  containers:
  - name: nginx
    image: nginx
```

```
template:
  metadata:
    labels:
      app: nginx
  spec:
    containers:
    - name: nginx
      image: nginx
```

# ReplicaSet



- Primary method of managing pod replicas and their lifecycle.
- Includes their scheduling, scaling, and deletion.
- Their job is simple: **Always ensure the desired number of pods are running.**

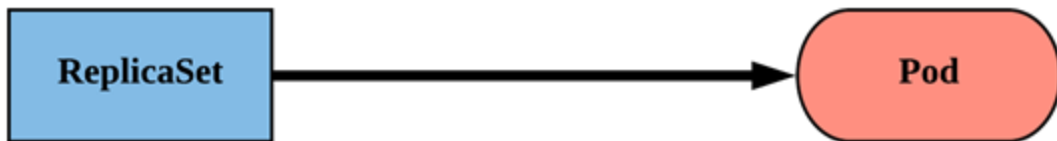

# ReplicaSet



- `replicas`: The desired number of instances of the Pod.
- `selector`: The label selector for the **ReplicaSet** will manage **ALL** Pod instances that it targets; whether it's desired or not.

```
apiVersion: apps/v1
kind: ReplicaSet
metadata:
  name: rs-example
spec:
  replicas: 3
  selector:
    matchLabels:
      app: nginx
      env: prod
  template:
    <pod template>
```

# ReplicaSet



```
apiVersion: apps/v1
kind: ReplicaSet
metadata:
  name: rs-example
spec:
  replicas: 3
  selector:
    matchLabels:
      app: nginx
      env: prod
  template:
    metadata:
      labels:
        app: nginx
        env: prod
    spec:
      containers:
      - name: nginx
        image: nginx:stable-alpine
        ports:
        - containerPort: 80
```

```
$ kubectl get pods
NAME                READY   STATUS    RESTARTS   AGE
rs-example-914dt    1/1     Running   0           1h
rs-example-b7bcg    1/1     Running   0           1h
rs-example-mk112    1/1     Running   0           1h
```

```
$ kubectl describe rs rs-example
Name:                rs-example
Namespace:           default
Selector:             app=nginx,env=prod
Labels:               app=nginx
                    env=prod
Annotations:          <none>
Replicas:             3 current / 3 desired
Pods Status:         3 Running / 0 Waiting / 0 Succeeded / 0 Failed
Pod Template:
  Labels:             app=nginx
                    env=prod
  Containers:
    nginx:
      Image:           nginx:stable-alpine
      Port:            80/TCP
      Environment:     <none>
      Mounts:          <none>
      Volumes:         <none>
Events:
  Type    Reason            Age   From                    Message
  ----    -
  Normal  SuccessfulCreate  16s   replicaset-controller   Created pod: rs-example-mk112
  Normal  SuccessfulCreate  16s   replicaset-controller   Created pod: rs-example-b7bcg
  Normal  SuccessfulCreate  16s   replicaset-controller   Created pod: rs-example-914dt
```

# Deployment



- Declarative method of managing Pods via **ReplicaSets**.
- Provide rollback functionality and update control.
- Updates are managed through the **pod-template-hash** label.
- Each iteration creates a unique label that is assigned to both the **ReplicaSet** and subsequent Pods.



# Deployment



- **revisionHistoryLimit**: The number of previous iterations of the Deployment to retain.
- **strategy**: Describes the method of updating the Pods based on the **type**. Valid options are **Recreate** or **RollingUpdate**.
  - **Recreate**: All existing Pods are killed before the new ones are created.
  - **RollingUpdate**: Cycles through updating the Pods according to the parameters: **maxSurge** and **maxUnavailable**.

```
apiVersion: apps/v1
kind: Deployment
metadata:
  name: deploy-example
spec:
  replicas: 3
  revisionHistoryLimit: 3
  selector:
    matchLabels:
      app: nginx
      env: prod
  strategy:
    type: RollingUpdate
    rollingUpdate:
      maxSurge: 1
      maxUnavailable: 0
  template:
    <pod template>
```

# RollingUpdate Deployment

Updating pod template generates a new **ReplicaSet** revision.

R1 pod-template-hash:  
676677fff  
R2 pod-template-hash:  
54f7ff7d6d

```
$ kubectl get replicaset
NAME                               DESIRED  CURRENT  READY  AGE
mydep-676677fff                    3         3        3      5h
```

```
$ kubectl get pods
NAME                                READY   STATUS    RESTARTS  AGE
mydep-676677fff-9r2zn               1/1    Running   0          5h
mydep-676677fff-hsfz9               1/1    Running   0          5h
mydep-676677fff-sjxhf               1/1    Running   0          5h
```

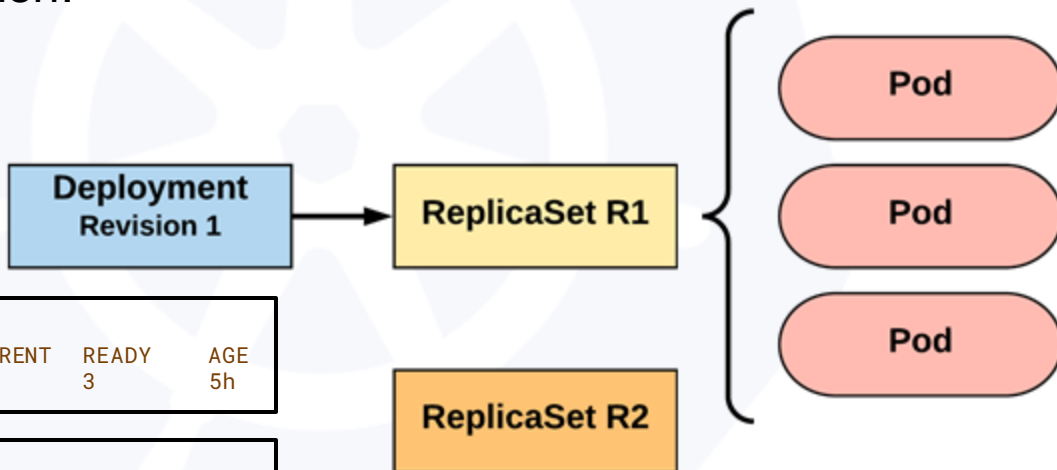



# RollingUpdate Deployment

New **ReplicaSet** is initially scaled up based on **maxSurge**.

R1 pod-template-hash:  
676677fff  
R2 pod-template-hash:  
54f7ff7d6d

Deployment  
Revision 2

ReplicaSet R1

Pod

Pod

Pod

ReplicaSet R2

Pod

```
$ kubectl get replicaset
```

NAME	DESIRED	CURRENT	READY	AGE
mydep-54f7ff7d6d	1	1	1	5s
mydep-676677fff	2	3	3	5h

```
$ kubectl get pods
```

NAME	READY	STATUS	RESTARTS	AGE
mydep-54f7ff7d6d-9gv1l	1/1	Running	0	2s
mydep-676677fff-9r2zn	1/1	Running	0	5h
mydep-676677fff-hsfz9	1/1	Running	0	5h
mydep-676677fff-sjxhf	1/1	Running	0	5h

# RollingUpdate Deployment

Phase out of old Pods managed by `maxSurge` and `maxUnavailable`.

R1 pod-template-hash:  
676677fff  
R2 pod-template-hash:  
54f7ff7d6d

Deployment  
Revision 2

ReplicaSet R1

Pod

Pod

~~Pod~~

ReplicaSet R2

Pod

Pod

```
$ kubectl get replicaset
```

NAME	DESIRED	CURRENT	READY	AGE
mydep-54f7ff7d6d	2	2	2	8s
mydep-6766777fff	2	2	2	5h

```
$ kubectl get pods
```

NAME	READY	STATUS	RESTARTS	AGE
mydep-54f7ff7d6d-9gv1l	1/1	Running	0	5s
mydep-54f7ff7d6d-cqv1q	1/1	Running	0	2s
mydep-6766777fff-9r2zn	1/1	Running	0	5h
mydep-6766777fff-hsfz9	1/1	Running	0	5h

# RollingUpdate Deployment

Phase out of old Pods managed by `maxSurge` and `maxUnavailable`.

R1 pod-template-hash:  
676677fff  
R2 pod-template-hash:  
54f7ff7d6d

Deployment  
Revision 2

ReplicaSet R1

ReplicaSet R2

Pod

~~Pod~~

~~Pod~~

Pod

Pod

Pod

```
$ kubectl get replicaset
```

NAME	DESIRED	CURRENT	READY	AGE
mydep-54f7ff7d6d	3	3	3	10s
mydep-676677fff	0	1	1	5h

```
$ kubectl get pods
```

NAME	READY	STATUS	RESTARTS	AGE
mydep-54f7ff7d6d-9gv1l	1/1	Running	0	7s
mydep-54f7ff7d6d-cqv1q	1/1	Running	0	5s
mydep-54f7ff7d6d-gccr6	1/1	Running	0	2s
mydep-676677fff-9r2zn	1/1	Running	0	5h

# RollingUpdate Deployment

Phase out of old Pods managed by `maxSurge` and `maxUnavailable`.

R1 pod-template-hash:  
676677fff  
R2 pod-template-hash:  
54f7ff7d6d

Deployment  
Revision 2

ReplicaSet R1

ReplicaSet R2



```
$ kubectl get replicaset
NAME                               DESIRED  CURRENT  READY  AGE
mydep-54f7ff7d6d                   3         3        3     13s
mydep-6766777fff                   0         0        0     5h
```

```
$ kubectl get pods
NAME                               READY    STATUS    RESTARTS  AGE
mydep-54f7ff7d6d-9gv1l            1/1     Running   0         10s
mydep-54f7ff7d6d-cqvlq            1/1     Running   0         8s
mydep-54f7ff7d6d-gccr6            1/1     Running   0         5s
```

# RollingUpdate Deployment

Updated to new deployment revision completed.

R1 pod-template-hash:  
676677fff  
R2 pod-template-hash:  
54f7ff7d6d

```
$ kubectl get replicaset
NAME                               DESIRED  CURRENT  READY  AGE
mydep-54f7ff7d6d                   3         3        3      15s
mydep-6766777fff                    0         0        0       5h
```

```
$ kubectl get pods
NAME                                READY   STATUS    RESTARTS  AGE
mydep-54f7ff7d6d-9gv1l             1/1     Running   0          12s
mydep-54f7ff7d6d-cqvlq             1/1     Running   0          10s
mydep-54f7ff7d6d-gccr6             1/1     Running   0           7s
```

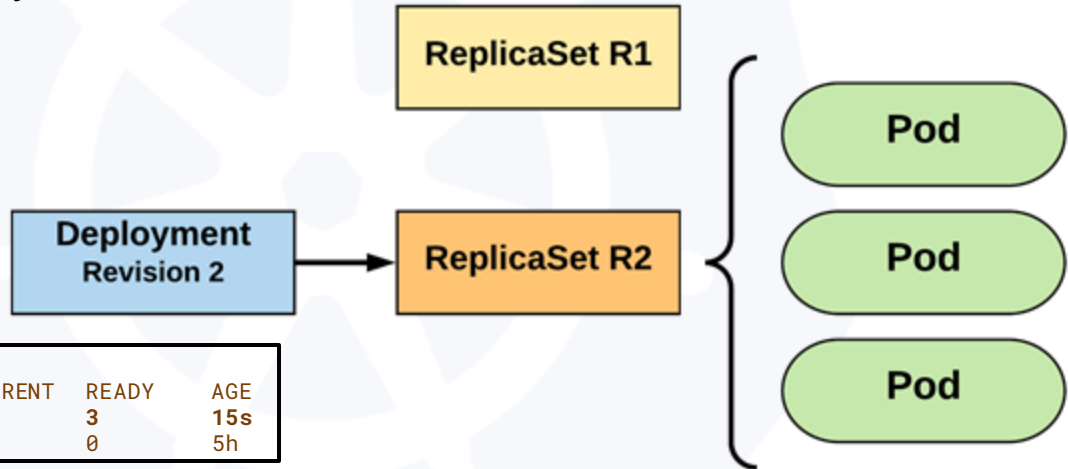

# DaemonSet



- Ensure that all nodes matching certain criteria will run an instance of the supplied Pod.
- They **bypass** default scheduling mechanisms.
- Are ideal for cluster wide services such as log forwarding, or health monitoring.
- Revisions are managed via a **controller-revision-hash** label.

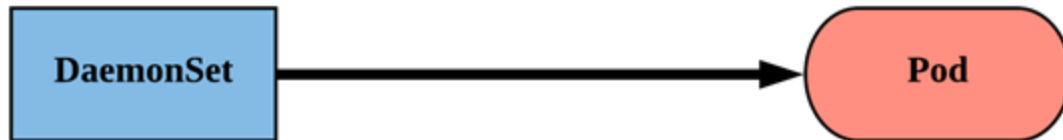

# DaemonSet



- **revisionHistoryLimit**: The number of previous iterations of the DaemonSet to retain.
- **updateStrategy**: Describes the method of updating the Pods based on the **type**. Valid options are **RollingUpdate** or **OnDelete**.
  - **RollingUpdate**: Cycles through updating the Pods according to the value of **maxUnavailable**.
  - **OnDelete**: The new instance of the Pod is deployed **ONLY** after the current instance is deleted.

```
apiVersion: apps/v1
kind: DaemonSet
metadata:
  name: ds-example
spec:
  revisionHistoryLimit: 3
  selector:
    matchLabels:
      app: nginx
  updateStrategy:
    type: RollingUpdate
    rollingUpdate:
      maxUnavailable: 1
  template:
    spec:
      nodeSelector:
        nodeType: edge
      <pod template>
```

# DaemonSet



- `spec.template.spec.nodeSelector`: The primary selector used to target nodes.
- **Default Host Labels:**
  - `kubernetes.io/hostname`
  - `beta.kubernetes.io/os`
  - `beta.kubernetes.io/arch`
- **Cloud Host Labels:**
  - `failure-domain.beta.kubernetes.io/zone`
  - `failure-domain.beta.kubernetes.io/region`
  - `beta.kubernetes.io/instance-type`
- <https://kubernetes.io/docs/reference/labels-annotations-taints/>

```
apiVersion: apps/v1
kind: DaemonSet
metadata:
  name: ds-example
spec:
  revisionHistoryLimit: 3
  selector:
    matchLabels:
      app: nginx
  updateStrategy:
    type: RollingUpdate
    rollingUpdate:
      maxUnavailable: 1
  template:
    spec:
      nodeSelector:
        nodeType: edge
      <pod template>
```



# DaemonSet



```
apiVersion: apps/v1
kind: DaemonSet
metadata:
  name: ds-example
spec:
  revisionHistoryLimit: 3
  selector:
    matchLabels:
      app: nginx
  updateStrategy:
    type: RollingUpdate
    rollingUpdate:
      maxUnavailable: 1
  template:
    metadata:
      labels:
        app: nginx
    spec:
      nodeSelector:
        nodeType: edge
      containers:
        - name: nginx
          image: nginx:stable-alpine
          ports:
            - containerPort: 80
```

```
$ kubectl get pods
NAME                READY   STATUS    RESTARTS   AGE
ds-example-x8kkz    1/1     Running   0           1m
```

```
$ kubectl describe ds ds-example
Name:                ds-example
Selector:            app=nginx,env=prod
Node-Selector:       nodeType=edge
Labels:              app=nginx
                    env=prod
Annotations:         <none>
Desired Number of Nodes Scheduled: 1
Current Number of Nodes Scheduled: 1
Number of Nodes Scheduled with Up-to-date Pods: 1
Number of Nodes Scheduled with Available Pods: 1
Number of Nodes Misscheduled: 0
Pods Status: 1 Running / 0 Waiting / 0 Succeeded / 0 Failed
Pod Template:
  Labels:  app=nginx
          env=prod
  Containers:
    nginx:
      Image:          nginx:stable-alpine
      Port:           80/TCP
      Environment:    <none>
      Mounts:         <none>
      Volumes:        <none>
Events:
  Type    Reason            Age   From                  Message
  ----    -
  Normal  SuccessfulCreate  48s   daemonset-controller  Created pod: ds-example-x8kkz
```

# DaemonSet



```
apiVersion: apps/v1
kind: DaemonSet
metadata:
  name: ds-example
spec:
  revisionHistoryLimit: 3
  selector:
    matchLabels:
      app: nginx
  updateStrategy:
    type: RollingUpdate
    rollingUpdate:
      maxUnavailable: 1
  template:
    metadata:
      labels:
        app: nginx
    spec:
      nodeSelector:
      nodeType: edge
    containers:
      - name: nginx
        image: nginx:stable-alpine
        ports:
          - containerPort: 80
```

```
$ kubectl get pods
NAME                READY   STATUS    RESTARTS   AGE
ds-example-x8kkz    1/1     Running   0           1m
```

```
$ kubectl describe ds ds-example
Name:                ds-example
Selector:             app=nginx,env=prod
Node-Selector:       nodeType=edge
Labels:               app=nginx
                    env=prod
Annotations:          <none>
Desired Number of Nodes Scheduled: 1
Current Number of Nodes Scheduled: 1
Number of Nodes Scheduled with Up-to-date Pods: 1
Number of Nodes Scheduled with Available Pods: 1
Number of Nodes Misscheduled: 0
Pods Status: 1 Running / 0 Waiting / 0 Succeeded / 0 Failed
Pod Template:
  Labels:  app=nginx
          env=prod
  Containers:
    nginx:
      Image:          nginx:stable-alpine
      Port:           80/TCP
      Environment:    <none>
      Mounts:         <none>
      Volumes:        <none>
Events:
  Type    Reason            Age   From                  Message
  ----    -
  Normal  SuccessfulCreate  48s   daemonset-controller  Created pod: ds-example-x8kkz
```

# StatefulSet



- Tailored to managing Pods that must persist or maintain state.
- Pod identity including **hostname**, **network**, and **storage WILL** be persisted.
- Assigned a unique ordinal name following the convention of '*<statefulset name>-<ordinal index>*'.



# StatefulSet



- Naming convention is also used in Pod's network Identity and Volumes.
- Pod lifecycle will be ordered and follow consistent patterns.
- Revisions are managed via a **controller-revision-hash** label

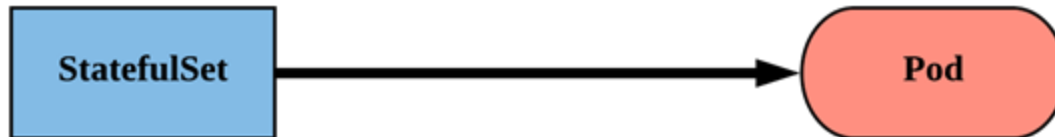

# StatefulSet



```
apiVersion: apps/v1
kind: StatefulSet
metadata:
  name: sts-example
spec:
  replicas: 2
  revisionHistoryLimit: 3
  selector:
    matchLabels:
      app: stateful
  serviceName: app
  updateStrategy:
    type: RollingUpdate
    rollingUpdate:
      partition: 0
  template:
    metadata:
      labels:
        app: stateful
    <continued>
```

```
<continued>
spec:
  containers:
    - name: nginx
      image: nginx:stable-alpine
      ports:
        - containerPort: 80
      volumeMounts:
        - name: www
          mountPath: /usr/share/nginx/html
  volumeClaimTemplates:
    - metadata:
        name: www
      spec:
        accessModes: [ "ReadWriteOnce" ]
        storageClassName: standard
        resources:
          requests:
            storage: 1Gi
```

# StatefulSet



- `revisionHistoryLimit`: The number of previous iterations of the StatefulSet to retain.
- `serviceName`: The name of the associated headless service; or a service without a **ClusterIP**.

```
apiVersion: apps/v1
kind: StatefulSet
metadata:
  name: sts-example
spec:
  replicas: 2
  revisionHistoryLimit: 3
  selector:
    matchLabels:
      app: stateful
  serviceName: app
  updateStrategy:
    type: RollingUpdate
  rollingUpdate:
    partition: 0
  template:
    <pod template>
```

# Headless Service

<StatefulSet Name>-<ordinal>.<service name>.<namespace>.svc.cluster.local

```
apiVersion: v1
kind: Service
metadata:
  name: app
spec:
  clusterIP: None
  selector:
    app: stateful
  ports:
    - protocol: TCP
      port: 80
      targetPort: 80
```

```
/ # dig app.default.svc.cluster.local +noall +answer

; <<>> DiG 9.11.2-P1 <<>> app.default.svc.cluster.local +noall +answer
;; global options: +cmd
app.default.svc.cluster.local. 2 IN A      10.255.0.5
app.default.svc.cluster.local. 2 IN A      10.255.0.2
```

```
/ # dig sts-example-0.app.default.svc.cluster.local +noall +answer

; <<>> DiG 9.11.2-P1 <<>> sts-example-0.app.default.svc.cluster.local +noall +answer
;; global options: +cmd
sts-example-0.app.default.svc.cluster.local. 20 IN A 10.255.0.2
```

```
$ kubectl get pods
NAME          READY   STATUS    RESTARTS
AGE
sts-example-0 1/1     Running   0
11m
sts-example-1 1/1     Running   0
11m
```

```
/ # dig sts-example-1.app.default.svc.cluster.local +noall +answer

; <<>> DiG 9.11.2-P1 <<>> sts-example-1.app.default.svc.cluster.local +noall +answer
;; global options: +cmd
sts-example-1.app.default.svc.cluster.local. 30 IN A 10.255.0.5
```

# Headless Service

<StatefulSet Name>-<ordinal>.<service name>.<namespace>.svc.cluster.local

```
apiVersion: v1
kind: Service
metadata:
  name: app
spec:
  clusterIP: None
  selector:
    app: stateful
  ports:
  - protocol: TCP
    port: 80
    targetPort: 80
```

```
/ # dig app.default.svc.cluster.local +noall +answer
; <<>> DiG 9.11.2-P1 <<>> app.default.svc.cluster.local +noall +answer
;; global options: +cmd
app.default.svc.cluster.local. 2 IN A      10.255.0.5
app.default.svc.cluster.local. 2 IN A      10.255.0.2
```

```
/ # dig sts-example-0.app.default.svc.cluster.local +noall +answer
; <<>> DiG 9.11.2-P1 <<>> sts-example-0.app.default.svc.cluster.local +noall +answer
;; global options: +cmd
sts-example-0.app.default.svc.cluster.local. 20 IN A 10.255.0.2
```

```
$ kubectl get pods
NAME                READY   STATUS    RESTARTS
AGE
sts-example-0       1/1     Running   0
11m
sts-example-1       1/1     Running   0
11m
```

```
/ # dig sts-example-1.app.default.svc.cluster.local +noall +answer
; <<>> DiG 9.11.2-P1 <<>> sts-example-1.app.default.svc.cluster.local +noall +answer
;; global options: +cmd
sts-example-1.app.default.svc.cluster.local. 30 IN A 10.255.0.5
```



# Headless Service

<StatefulSet Name>-<ordinal>.<service name>.<namespace>.svc.cluster.local

```
apiVersion: v1
kind: Service
metadata:
  name: app
spec:
  clusterIP: None
  selector:
    app: stateful
  ports:
  - protocol: TCP
    port: 80
    targetPort: 80
```

```
/ # dig app.default.svc.cluster.local +noall +answer

; <<>> DiG 9.11.2-P1 <<>> app.default.svc.cluster.local +noall +answer
;; global options: +cmd
app.default.svc.cluster.local. 2 IN A      10.255.0.5
app.default.svc.cluster.local. 2 IN A      10.255.0.2
```

```
/ # dig sts-example-0.app.default.svc.cluster.local +noall +answer

; <<>> DiG 9.11.2-P1 <<>> sts-example-0.app.default.svc.cluster.local +noall +answer
;; global options: +cmd
sts-example-0.app.default.svc.cluster.local. 20 IN A 10.255.0.2
```

```
$ kubectl get pods
NAME                READY   STATUS    RESTARTS
AGE
sts-example-0       1/1     Running   0
11m
sts-example-1       1/1     Running   0
11m
```

```
/ # dig sts-example-1.app.default.svc.cluster.local +noall +answer

; <<>> DiG 9.11.2-P1 <<>> sts-example-1.app.default.svc.cluster.local +noall +answer
;; global options: +cmd
sts-example-1.app.default.svc.cluster.local. 30 IN A 10.255.0.5
```

# StatefulSet



- **updateStrategy**: Describes the method of updating the Pods based on the **type**. Valid options are **OnDelete** or **RollingUpdate**.
  - **OnDelete**: The new instance of the Pod is deployed **ONLY** after the current instance is deleted.
  - **RollingUpdate**: Pods with an ordinal greater than the **partition** value will be updated in one-by-one in reverse order.

```
apiVersion: apps/v1
kind: StatefulSet
metadata:
  name: sts-example
spec:
  replicas: 2
  revisionHistoryLimit: 3
  selector:
    matchLabels:
      app: stateful
  serviceName: app
  updateStrategy:
    type: RollingUpdate
    rollingUpdate:
      partition: 0
  template:
    <pod template>
```

# StatefulSet



- **volumeClaimTemplates:**  
Template of the persistent volume(s) request to use for each instance of the StatefulSet.
- **accessModes:**
  - ReadWriteOnce – the volume can be mounted as read-write by a single node
  - ReadOnlyMany – the volume can be mounted read-only by many nodes
  - ReadWriteMany – the volume can be mounted as read-write by many nodes

<https://kubernetes.io/docs/concepts/storage/persistent-volumes/#access-modes>

```
spec:
  containers:
  - name: nginx
    image: nginx:stable-alpine
    ports:
    - containerPort: 80
    volumeMounts:
    - name: www
      mountPath: /usr/share/nginx/html
  volumeClaimTemplates:
  - metadata:
    name: www
    spec:
      accessModes: [ "ReadWriteOnce" ]
      storageClassName: standard
      resources:
        requests:
          storage: 1Gi
```

# VolumeClaimTemplate

<Volume Name>-<StatefulSet Name>-<ordinal>

```
volumeClaimTemplates:
- metadata:
  name: www
  spec:
    accessModes: [ "ReadWriteOnce" ]
    storageClassName: standard
    resources:
      requests:
        storage: 1Gi
```

Persistent Volumes associated with a StatefulSet will **NOT** be automatically garbage collected when the associated StatefulSet is deleted. They must manually be removed.

```
$ kubectl get pvc
NAME                STATUS   VOLUME                                     CAPACITY   ACCESS MODES   STORAGECLASS   AGE
www-sts-example-0   Bound   pvc-d2f11e3b-18d0-11e8-ba4f-080027a3682b  1Gi        RWO            standard       4h
www-sts-example-1   Bound   pvc-d3c923c0-18d0-11e8-ba4f-080027a3682b  1Gi        RWO            standard       4h
```

# Job



- Job controller ensures one or more pods are executed and successfully terminate.
- Will continue to try and execute the job until it satisfies the completion and/or parallelism condition.
- Pods are **NOT** cleaned up until the job itself is deleted.

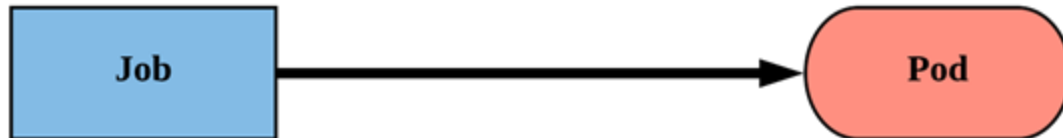

# Job



- `backoffLimit`: The number of failures before the job itself is considered **failed**.
- `completions`: The total number of successful completions desired.
- `parallelism`: How many instances of the pod can be run concurrently.
- `spec.template.spec.restartPolicy`: Jobs only support a `restartPolicy` of type **Never** or **OnFailure**.

```
apiVersion: batch/v1
kind: Job
metadata:
  name: job-example
spec:
  backoffLimit: 4
  completions: 4
  parallelism: 2
  template:
    spec:
      restartPolicy: Never
    <pod-template>
```

# Job



```
apiVersion: batch/v1
kind: Job
metadata:
  name: job-example
spec:
  backoffLimit: 4
  completions: 4
  parallelism: 2
  template:
    spec:
      containers:
      - name: hello
        image: alpine:latest
        command: ["/bin/sh", "-c"]
        args: ["echo hello from $HOSTNAME!"]
        restartPolicy: Never
```

```
$ kubectl get pods --show-all
NAME                READY   STATUS    RESTARTS   AGE
job-example-dvxd2   0/1     Completed 0           51m
job-example-hknns   0/1     Completed 0           52m
job-example-tphkm   0/1     Completed 0           51m
job-example-v5fvq   0/1     Completed 0           52m
```

```
$ kubectl describe job job-example
Name:                job-example
Namespace:           default
Selector:             controller-uid=19d122f4-1576-11e8-a4e2-080027a3682b
Labels:               controller-uid=19d122f4-1576-11e8-a4e2-080027a3682b
                    job-name=job-example
Annotations:          <none>
Parallelism:         2
Completions:         4
Start Time:          Mon, 19 Feb 2018 08:09:21 -0500
Pods Statuses:       0 Running / 4 Succeeded / 0 Failed
Pod Template:
  Labels:             controller-uid=19d122f4-1576-11e8-a4e2-080027a3682b
                    job-name=job-example
Containers:
  hello:
    Image:            alpine:latest
    Port:             <none>
    Command:
      /bin/sh
      -c
    Args:
      echo hello from $HOSTNAME!
    Environment:      <none>
    Mounts:           <none>
    Volumes:          <none>
Events:
  Type     Reason          Age   From             Message
  ----     -
  Normal   SuccessfulCreate 52m   job-controller   Created pod: job-example-v5fvq
  Normal   SuccessfulCreate 52m   job-controller   Created pod: job-example-hknns
  Normal   SuccessfulCreate 51m   job-controller   Created pod: job-example-tphkm
  Normal   SuccessfulCreate 51m   job-controller   Created pod: job-example-dvxd2
```

# TL;DR



- K8S Jobs are used when you want to **create pods that will do a specific task and then exit.**
- K8S Jobs do **not need pod selectors** by default as pods; their labels and selectors are handled **automatically** by the Job.
- The restartPolicy for a Job accepts “**Never**” and “**OnFailure**”
- Jobs use **completion and parallelism** parameters to control the patterns the pods run through.
  - Job pods can run as a **single task, several sequential tasks, or some parallel tasks** in which the first task that finishes instructs the rest of the pods to complete and exit.
- You can control how many times a Job attempts to restart a failing pod using the **.spec.backoffLimit**. This limit defaults to six.
- You can control how long a job will run using the **.spec.activeDeadlineSeconds**.
  - This limit **overrides the backoffLimit** -> the Job does not attempt to restart a failing pod if the deadline is reached.
- Jobs and their pods **do not get deleted automatically** when they finish. You have to manually delete them or use the **ttlSecondsAfterFinished** controller (Kubernetes v1.23 [stable])



# CronJob



An extension of the Job Controller, it provides a method of executing jobs on a cron-like schedule.

All **CronJob** times are based on the timezone of the [kube-controller-manager](#).

If your control plane runs the kube-controller-manager in Pods or bare containers, the timezone set for the kube-controller-manager container determines the timezone that the cron job controller uses.



# CronJob



- `schedule`: The cron schedule for the job.
- `successfulJobHistoryLimit`: The number of successful jobs to retain.
- `failedJobHistoryLimit`: The number of failed jobs to retain.

```
apiVersion: batch/v1beta1
kind: CronJob
metadata:
  name: cronjob-example
spec:
  schedule: "*/1 * * * *"
  successfulJobsHistoryLimit: 3
  failedJobsHistoryLimit: 1
  jobTemplate:
    spec:
      completions: 4
      parallelism: 2
      template:
        <pod template>
```

# CronJob



```
apiVersion: batch/v1beta1
kind: CronJob
metadata:
  name: cronjob-example
spec:
  schedule: "*/1 * * * *"
  successfulJobsHistoryLimit: 3
  failedJobsHistoryLimit: 1
  jobTemplate:
    spec:
      completions: 4
      parallelism: 2
      template:
        spec:
          containers:
            - name: hello
              image: alpine:latest
              command: ["/bin/sh", "-c"]
              args: ["echo hello from $HOSTNAME!"]
              restartPolicy: Never
```

```
$ kubectl get jobs
NAME                                DESIRED    SUCCESSFUL    AGE
cronjob-example-1519053240          4           4             2m
cronjob-example-1519053300          4           4             1m
cronjob-example-1519053360          4           4            26s
```

```
$ kubectl describe cronjob cronjob-example
Name:                cronjob-example
Namespace:           default
Labels:              <none>
Annotations:         <none>
Schedule:            */1 * * * *
Concurrency Policy:  Allow
Suspend:             False
Starting Deadline Seconds: <unset>
Selector:            <unset>
Parallelism:        2
Completions:        4
Pod Template:
  Labels: <none>
  Containers:
    hello:
      Image:   alpine:latest
      Port:    <none>
      Command:
        /bin/sh
        -c
      Args:
        echo hello from $HOSTNAME!
      Environment: <none>
      Mounts:      <none>
      Volumes:     <none>
  Last Schedule Time: Mon, 19 Feb 2018 09:54:00 -0500
  Active Jobs:       cronjob-example-1519052040
Events:
  Type      Reason          Age   From              Message
  ----      -
  Normal    SuccessfulCreate 3m    cronjob-controller Created job cronjob-example-1519051860
  Normal    SawCompletedJob  2m    cronjob-controller Saw completed job: cronjob-example-1519051860
  Normal    SuccessfulCreate  2m    cronjob-controller Created job cronjob-example-1519051920
  Normal    SawCompletedJob  1m    cronjob-controller Saw completed job: cronjob-example-1519051920
  Normal    SuccessfulCreate  1m    cronjob-controller Created job cronjob-example-1519051980
```

# Hands-on: Workloads



<https://github.com/caifti/k8s-intro-tutorials/tree/master/workloads>

# Storage

- Volumes
- Persistent Volumes
- Persistent Volume Claims
- StorageClass

# Storage



Pods by themselves are useful, but many workloads require exchanging data between containers, or persisting some form of data.

For this we have **Volumes**, **PersistentVolumes**, **PersistentVolumeClaims**, and **StorageClasses**.

# Volumes



- Storage that is tied to the **Pod's Lifecycle**.
- A pod can have one or more types of volumes attached to it.
- Can be consumed by any of the containers within the pod.
- Survive Pod restarts; however their durability beyond that is dependent on the Volume Type.

# Volume Types



- awsElasticBlockStore
- azureDisk
- azureFile
- cephfs
- configMap
- csi
- downwardAPI
- emptyDir
- fc (fibre channel)
- flocker
- gcePersistentDisk
- gitRepo
- glusterfs
- hostPath
- iscsi
- local
- nfs
- persistentVolume Claim
- projected
- portworxVolume
- quobyte
- rbd
- scaleIO
- secret
- storageos
- vsphereVolume



Persistent Volume Supported



# Volumes



- **volumes**: A list of volume objects to be attached to the Pod. Every object within the list must have its own unique **name**.
- **volumeMounts**: A container specific list referencing the Pod volumes by **name**, along with their desired **mountPath**.

```
apiVersion: v1
kind: Pod
metadata:
  name: volume-example
spec:
  containers:
  - name: nginx
    image: nginx:stable-alpine
    volumeMounts:
    - name: html
      mountPath: /usr/share/nginx/html
      ReadOnly: true
  - name: content
    image: alpine:latest
    command: ["/bin/sh", "-c"]
    args:
    - while true; do
      date >> /html/index.html;
      sleep 5;
    done
    volumeMounts:
    - name: html
      mountPath: /html
  volumes:
  - name: html
    emptyDir: {}
```

# Volumes



- **volumes**: A list of volume objects to be attached to the Pod. Every object within the list must have its own unique **name**.
- **volumeMounts**: A container specific list referencing the Pod volumes by **name**, along with their desired **mountPath**.

```
apiVersion: v1
kind: Pod
metadata:
  name: volume-example
spec:
  containers:
  - name: nginx
    image: nginx:stable-alpine
    volumeMounts:
    - name: html
      mountPath: /usr/share/nginx/html
      ReadOnly: true
  - name: content
    image: alpine:latest
    command: ["/bin/sh", "-c"]
    args:
    - while true; do
      date >> /html/index.html;
      sleep 5;
    done
    volumeMounts:
    - name: html
      mountPath: /html
  volumes:
  - name: html
    emptyDir: {}
```

# Volumes



- **volumes**: A list of volume objects to be attached to the Pod. Every object within the list must have its own unique **name**.

- **volumeMounts**: A container specific list referencing the Pod volumes by **name**, along with their desired **mountPath**.

```
apiVersion: v1
kind: Pod
metadata:
  name: volume-example
spec:
  containers:
  - name: nginx
    image: nginx:stable-alpine
    volumeMounts:
    - name: html
      mountPath: /usr/share/nginx/html
      ReadOnly: true
  - name: content
    image: alpine:latest
    command: ["/bin/sh", "-c"]
    args:
    - while true; do
      date >> /html/index.html;
      sleep 5;
    done
    volumeMounts:
    - name: html
      mountPath: /html
  volumes:
  - name: html
    emptyDir: {}
```

# Persistent Volumes



- A **PersistentVolume** (PV) represents a storage resource.
- PVs are a **cluster wide resource** linked to a backing storage provider: NFS, GCEPersistentDisk, RBD etc.
- Generally provisioned by an administrator.
- Their lifecycle is handled independently from a pod
- **CANNOT** be attached to a Pod directly. Relies on a **PersistentVolumeClaim**

# PersistentVolumeClaims



- A **PersistentVolumeClaim** (PVC) is a **namespaced** request for storage.
- Satisfies a set of requirements instead of mapping to a storage resource directly.
- Ensures that an application's '*claim*' for storage is portable across numerous backends or providers.

# Persistent Volumes and Claims

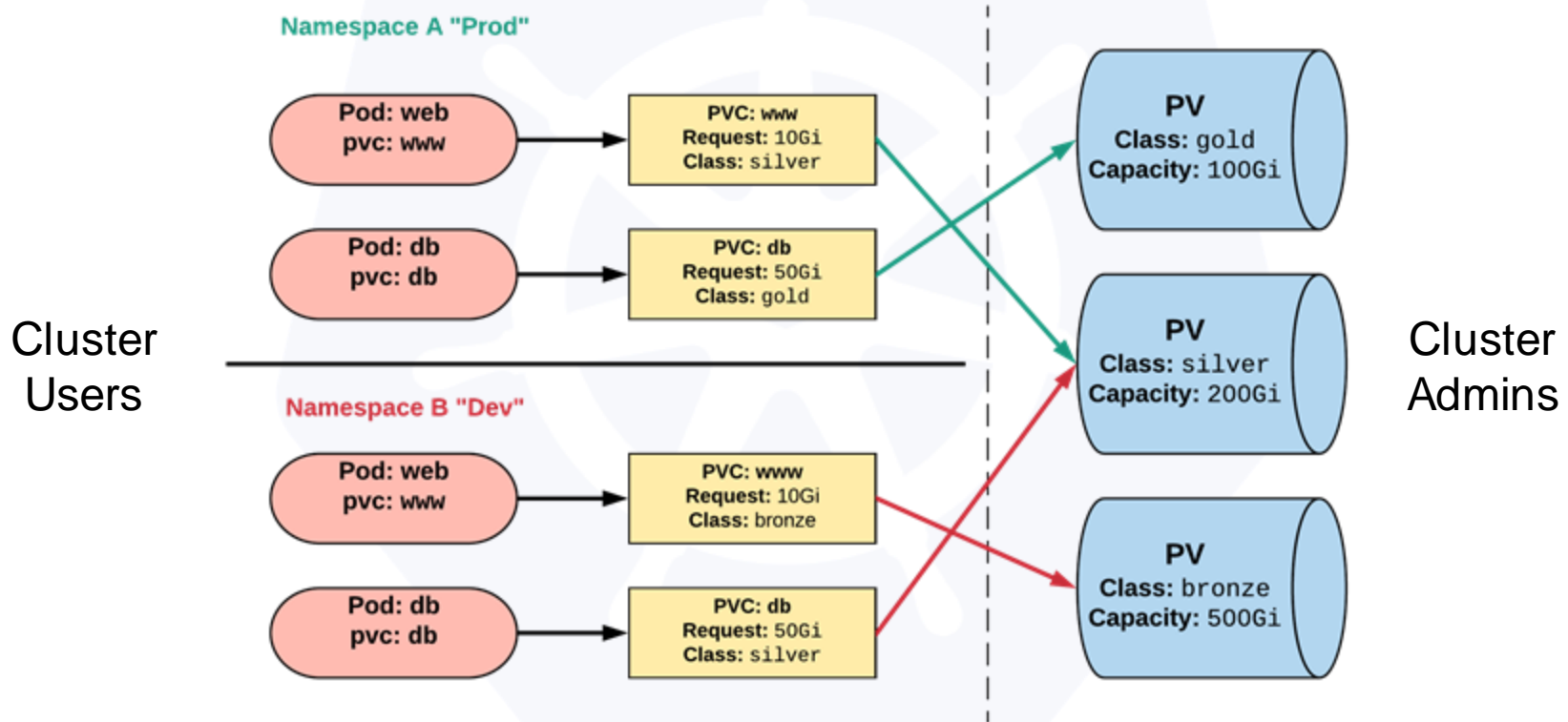

# PersistentVolume



- `capacity.storage`: The total amount of available storage.
- `volumeMode`: The type of volume, this can be either `Filesystem` or `Block`.
- `accessModes`: A list of the supported methods of accessing the volume. Options include:
  - `ReadWriteOnce`
  - `ReadOnlyMany`
  - `ReadWriteMany`

```
apiVersion: v1
kind: PersistentVolume
metadata:
  name: nfsserver
spec:
  capacity:
    storage: 50Gi
  volumeMode: Filesystem
  accessModes:
    - ReadWriteOnce
    - ReadWriteMany
  persistentVolumeReclaimPolicy: Delete
  storageClassName: slow
  mountOptions:
    - hard
    - nfsvers=4.1
  nfs:
    path: /exports
    server: 172.22.0.42
```

# PersistentVolume



- `persistentVolumeReclaimPolicy`: The behaviour for PVC's that have been deleted. Options include:
  - **Retain** - manual clean-up
  - **Delete** - storage asset deleted by provider.
- `storageClassName`: Optional name of the storage class that PVC's can reference. If provided, **ONLY** PVC's referencing the name consume use it.
- `mountOptions`: Optional mount options for the PV.

```
apiVersion: v1
kind: PersistentVolume
metadata:
  name: nfsserver
spec:
  capacity:
    storage: 50Gi
  volumeMode: Filesystem
  accessModes:
    - ReadWriteOnce
    - ReadWriteMany
  persistentVolumeReclaimPolicy: Delete
  storageClassName: slow
  mountOptions:
    - hard
    - nfsvers=4.1
  nfs:
    path: /exports
    server: 172.22.0.42
```



# PersistentVolumeClaim



- `accessModes`: The selected method of accessing the storage. This **MUST** be a subset of what is defined on the target PV or Storage Class.
  - `ReadWriteOnce`
  - `ReadOnlyMany`
  - `ReadWriteMany`
- `resources.requests.storage`: The desired amount of storage for the claim
- `storageClassName`: The name of the desired Storage Class

```
kind: PersistentVolumeClaim
apiVersion: v1
metadata:
  name: pvc-sc-example
spec:
  accessModes:
    - ReadWriteOnce
  resources:
    requests:
      storage: 1Gi
  storageClassName: slow
```

# PVs and PVCs with Selectors



```
kind: PersistentVolume
apiVersion: v1
metadata:
  name: pv-selector-example
  labels:
    type: hostpath
spec:
  capacity:
    storage: 2Gi
  accessModes:
    - ReadWriteMany
  hostPath:
    path: "/mnt/data"
```

```
kind: PersistentVolumeClaim
apiVersion: v1
metadata:
  name: pvc-selector-example
spec:
  accessModes:
    - ReadWriteMany
  resources:
    requests:
      storage: 1Gi
  selector:
    matchLabels:
      type: hostpath
```

# PVs and PVCs with Selectors



```
kind: PersistentVolume
apiVersion: v1
metadata:
  name: pv-selector-example
  labels:
    type: hostpath
spec:
  capacity:
    storage: 2Gi
  accessModes:
    - ReadWriteMany
  hostPath:
    path: "/mnt/data"
```

```
kind: PersistentVolumeClaim
apiVersion: v1
metadata:
  name: pvc-selector-example
spec:
  accessModes:
    - ReadWriteMany
  resources:
    requests:
      storage: 1Gi
  selector:
    matchLabels:
      type: hostpath
```

# PV Phases



## Available

PV is ready and available to be consumed.

## Bound

The PV has been bound to a claim.

## Released

The binding PVC has been deleted, and the PV is pending reclamation.

## Failed

An error has been encountered attempting to reclaim the PV.

# StorageClass



- Storage classes are an abstraction on top of an external storage resource (PV)
- Work hand-in-hand with the external storage system to enable **dynamic provisioning** of storage
- Eliminates the need for the cluster admin to pre-provision a PV

# StorageClass

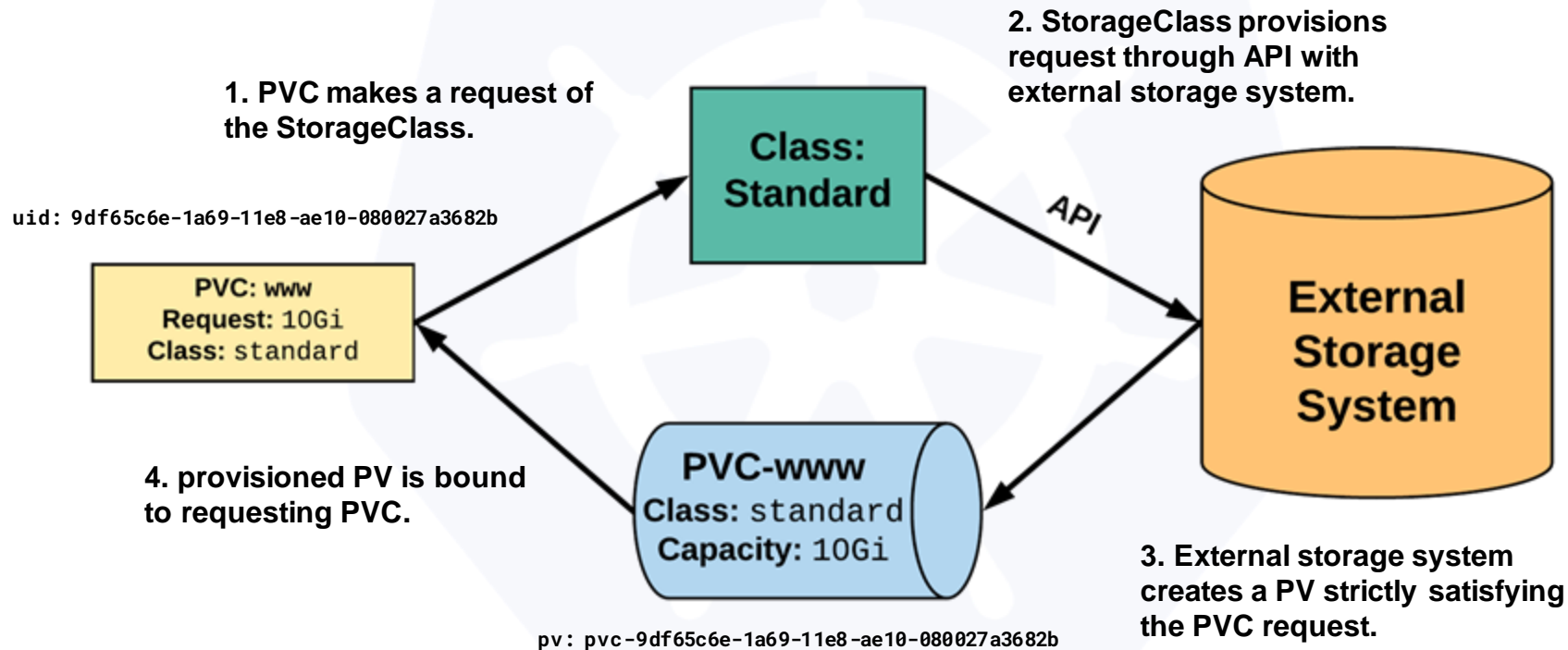

# StorageClass



- **provisioner**: Defines the *'driver'* to be used for provisioning of the external storage.
- **parameters**: A hash of the various configuration parameters for the provisioner.
- **reclaimPolicy**: The behaviour for the backing storage when the PVC is deleted.
  - **Retain** - manual clean-up
  - **Delete** - storage asset deleted by provider

```
kind: StorageClass
apiVersion: storage.k8s.io/v1
metadata:
  name: standard
provisioner: kubernetes.io/gce-pd
parameters:
  type: pd-standard
  zones: us-central1-a, us-central1-b
reclaimPolicy: Delete
```

# Available StorageClasses



- AWSElasticBlockStore
- AzureFile
- AzureDisk
- CephFS
- Cinder
- FC
- Flocker
- GCEPersistentDisk
- Glusterfs
- iSCSI
- Quobyte
- NFS
- RBD
- VsphereVolume
- PortworxVolume
- ScaleIO
- StorageOS
- Local

 Internal Provisioner



# Hands-on: Working with Volumes



<https://github.com/caifti/k8s-intro-tutorials/tree/master/storage>

# Configuration

- ConfigMap
- Secret

# Configuration



Kubernetes has an integrated pattern for decoupling configuration from application or container.

This pattern makes use of two Kubernetes components: **ConfigMaps** and **Secrets**.

# ConfigMap



- Externalized data stored within kubernetes.
- Can be referenced through several different means:
  - environment variable
  - a command line argument (via env var)
  - injected as a file into a volume mount
- Can be created from a manifest, literals, directories, or files directly.

# ConfigMap



`data`: Contains key-value pairs of ConfigMap contents.

```
apiVersion: v1
kind: ConfigMap
metadata:
  name: manifest-example
data:
  state: Michigan
  city: Ann Arbor
  content: |
    Look at this,
    its multiline!
```

# ConfigMap Example

All produce a **ConfigMap** with the same content!

```
apiVersion: v1
kind: ConfigMap
metadata:
  name: manifest-example
data:
  city: Ann Arbor
  state: Michigan
```

```
$ kubectl create configmap literal-example \
> --from-literal="city=Ann Arbor" --from-literal=state=Michigan
configmap "literal-example" created
```

```
$ cat info/city
Ann Arbor
$ cat info/state
Michigan
$ kubectl create configmap dir-example --from-file=cm/
configmap "dir-example" created
```

```
$ cat info/city
Ann Arbor
$ cat info/state
Michigan
$ kubectl create configmap file-example --from-file=cm/city --from-file=cm/state
configmap "file-example" created
```

# ConfigMap Example

All produce a **ConfigMap** with the same content!

```
apiVersion: v1
kind: ConfigMap
metadata:
  name: manifest-example
data:
  city: Ann Arbor
  state: Michigan
```

```
$ kubectl create configmap literal-example \
> --from-literal="city=Ann Arbor" --from-literal=state=Michigan
configmap "literal-example" created
```

```
$ cat info/city
Ann Arbor
$ cat info/state
Michigan
$ kubectl create configmap dir-example --from-file=cm/
configmap "dir-example" created
```

```
$ cat info/city
Ann Arbor
$ cat info/state
Michigan
$ kubectl create configmap file-example --from-file=cm/city --from-file=cm/state
configmap "file-example" created
```

# ConfigMap Example

All produce a **ConfigMap** with the same content!

```
apiVersion: v1
kind: ConfigMap
metadata:
  name: manifest-example
data:
  city: Ann Arbor
  state: Michigan
```

```
$ kubectl create configmap literal-example \
> --from-literal="city=Ann Arbor" --from-literal=state=Michigan
configmap "literal-example" created
```

```
$ cat info/city
Ann Arbor
$ cat info/state
Michigan
$ kubectl create configmap dir-example --from-file=cm/
configmap "dir-example" created
```

```
$ cat info/city
Ann Arbor
$ cat info/state
Michigan
$ kubectl create configmap file-example --from-file=cm/city --from-file=cm/state
configmap "file-example" created
```



# ConfigMap Example

All produce a **ConfigMap** with the same content!

```
apiVersion: v1
kind: ConfigMap
metadata:
  name: manifest-example
data:
  city: Ann Arbor
  state: Michigan
```

```
$ kubectl create configmap literal-example \
> --from-literal="city=Ann Arbor" --from-literal=state=Michigan
configmap "literal-example" created
```

```
$ cat info/city
Ann Arbor
$ cat info/state
Michigan
$ kubectl create configmap dir-example --from-file=cm/
configmap "dir-example" created
```

```
$ cat info/city
Ann Arbor
$ cat info/state
Michigan
$ kubectl create configmap file-example --from-file=cm/city --from-file=cm/state
configmap "file-example" created
```

# Secret



- Functionally identical to a ConfigMap.
- Stored as **base64 encoded content**.
- Encrypted at rest within etcd (**if configured!**).
- Ideal for username/passwords, certificates or other sensitive information that should not be stored in a container.
- Can be created from a manifest, literals, directories, or from files directly.

# Secret



- **type**: There are three different types of secrets within Kubernetes:
  - **docker-registry** - credentials used to authenticate to a container registry
  - **generic/Opaque** - literal values from different sources
  - **tls** - a certificate based secret
- **data**: Contains key-value pairs of base64 encoded content.

```
apiVersion: v1
kind: Secret
metadata:
  name: manifest-secret
type: Opaque
data:
  username: ZXhhbXBsZQ==
  password: bXlwYXNzd29yZA==
```

# Secret Example

All produce a **Secret** with the same content!

```
apiVersion: v1
kind: Secret
metadata:
  name: manifest-example
type: Opaque
data:
  username: ZXhhbXBsZQ==
  password: bXlwYXNzd29yZA==
```

```
$ kubectl create secret generic literal-secret \
> --from-literal=username=example \
> --from-literal=password=mypassword
secret "literal-secret" created
```

```
$ cat info/username
example
$ cat info/password
mypassword
$ kubectl create secret generic dir-secret --from-file=secret/
Secret "file-secret" created
```

```
$ cat secret/username
example
$ cat secret/password
mypassword
$ kubectl create secret generic file-secret --from-file=secret/username --from-file=secret/password
Secret "file-secret" created
```

# Secret Example

All produce a **Secret** with the same content!

```
apiVersion: v1
kind: Secret
metadata:
  name: manifest-example
type: Opaque
data:
  username: ZXhhbXBsZQ==
  password: bXlwYXNzd29yZA==
```

```
$ kubectl create secret generic literal-secret \
> --from-literal=username=example \
> --from-literal=password=myspassword
secret "literal-secret" created
```

```
$ cat info/username
example
$ cat info/password
myspassword
$ kubectl create secret generic dir-secret --from-file=secret/
Secret "file-secret" created
```

```
$ cat secret/username
example
$ cat secret/password
myspassword
$ kubectl create secret generic file-secret --from-file=secret/username --from-file=secret/password
Secret "file-secret" created
```

# Secret Example

All produce a **Secret** with the same content!

```
apiVersion: v1
kind: Secret
metadata:
  name: manifest-example
type: Opaque
data:
  username: ZXhhbXBsZQ==
  password: bXlwYXNzd29yZA==
```

```
$ kubectl create secret generic literal-secret \
> --from-literal=username=example \
> --from-literal=password=mypassword
secret "literal-secret" created
```

```
$ cat info/username
example
$ cat info/password
mypassword
$ kubectl create secret generic dir-secret --from-file=secret/
Secret "file-secret" created
```

```
$ cat secret/username
example
$ cat secret/password
mypassword
$ kubectl create secret generic file-secret --from-file=secret/username --from-file=secret/password
Secret "file-secret" created
```

# Secret Example

All produce a **Secret** with the same content!

```
apiVersion: v1
kind: Secret
metadata:
  name: manifest-example
type: Opaque
data:
  username: ZXhhbXBsZQ==
  password: bXlwYXNzd29yZA==
```

```
$ kubectl create secret generic literal-secret \
> --from-literal=username=example \
> --from-literal=password=myspassword
secret "literal-secret" created
```

```
$ cat info/username
example
$ cat info/password
myspassword
$ kubectl create secret generic dir-secret --from-file=secret/
Secret "file-secret" created
```

```
$ cat secret/username
example
$ cat secret/password
myspassword
$ kubectl create secret generic file-secret --from-file=secret/username --from-file=secret/password
Secret "file-secret" created
```

# Injecting as Environment Variable



```
apiVersion: batch/v1
kind: Job
metadata:
  name: cm-env-example
spec:
  template:
    spec:
      containers:
      - name: mypod
        image: alpine:latest
        command: ["/bin/sh", "-c"]
        args: ["printenv CITY"]
        env:
        - name: CITY
          valueFrom:
            configMapKeyRef:
              name: manifest-example
              key: city
        restartPolicy: Never
```

```
apiVersion: batch/v1
kind: Job
metadata:
  name: secret-env-example
spec:
  template:
    spec:
      containers:
      - name: mypod
        image: alpine:latest
        command: ["/bin/sh", "-c"]
        args: ["printenv USERNAME"]
        env:
        - name: USERNAME
          valueFrom:
            secretKeyRef:
              name: manifest-example
              key: username
        restartPolicy: Never
```



# Injecting as Environment Variable



```
apiVersion: batch/v1
kind: Job
metadata:
  name: cm-env-example
spec:
  template:
    spec:
      containers:
      - name: mypod
        image: alpine:latest
        command: ["/bin/sh", "-c"]
        args: ["printenv CITY"]
        env:
        - name: CITY
          valueFrom:
            configMapKeyRef:
              name: manifest-example
              key: city
      restartPolicy: Never
```

```
apiVersion: batch/v1
kind: Job
metadata:
  name: secret-env-example
spec:
  template:
    spec:
      containers:
      - name: mypod
        image: alpine:latest
        command: ["/bin/sh", "-c"]
        args: ["printenv USERNAME"]
        env:
        - name: USERNAME
          valueFrom:
            secretKeyRef:
              name: manifest-example
              key: username
      restartPolicy: Never
```

# Injecting in a Command



```
apiVersion: batch/v1
kind: Job
metadata:
  name: cm-cmd-example
spec:
  template:
    spec:
      containers:
      - name: mypod
        image: alpine:latest
        command: ["/bin/sh", "-c"]
        args: ["echo Hello ${CITY}!"]
        env:
        - name: CITY
          valueFrom:
            configMapKeyRef:
              name: manifest-example
              key: city
        restartPolicy: Never
```

```
apiVersion: batch/v1
kind: Job
metadata:
  name: secret-cmd-example
spec:
  template:
    spec:
      containers:
      - name: mypod
        image: alpine:latest
        command: ["/bin/sh", "-c"]
        args: ["echo Hello ${USERNAME}!"]
        env:
        - name: USERNAME
          valueFrom:
            secretKeyRef:
              name: manifest-example
              key: username
        restartPolicy: Never
```

# Injecting in a Command



```
apiVersion: batch/v1
kind: Job
metadata:
  name: cm-cmd-example
spec:
  template:
    spec:
      containers:
      - name: mvpod
        image: alpine:latest
        command: ["/bin/sh", "-c"]
        args: ["echo Hello ${CITY}!"]
        env:
        - name: CITY
          valueFrom:
            configMapKeyRef:
              name: manifest-example
              key: city
      restartPolicy: Never
```

```
apiVersion: batch/v1
kind: Job
metadata:
  name: secret-cmd-example
spec:
  template:
    spec:
      containers:
      - name: mvpod
        image: alpine:latest
        command: ["/bin/sh", "-c"]
        args: ["echo Hello ${USERNAME}!"]
        env:
        - name: USERNAME
          valueFrom:
            secretKeyRef:
              name: manifest-example
              key: username
      restartPolicy: Never
```

# Injecting as a Volume



```
apiVersion: batch/v1
kind: Job
metadata:
  name: cm-vol-example
spec:
  template:
    spec:
      containers:
      - name: mypod
        image: alpine:latest
        command: ["/bin/sh", "-c"]
        args: ["cat /myconfig/city"]
        volumeMounts:
        - name: config-volume
          mountPath: /myconfig
          restartPolicy: Never
      volumes:
      - name: config-volume
        configMap:
          name: manifest-example
```

```
apiVersion: batch/v1
kind: Job
metadata:
  name: secret-vol-example
spec:
  template:
    spec:
      containers:
      - name: mypod
        image: alpine:latest
        command: ["/bin/sh", "-c"]
        args: ["cat /mysecret/username"]
        volumeMounts:
        - name: secret-volume
          mountPath: /mysecret
          restartPolicy: Never
      volumes:
      - name: secret-volume
        secret:
          secretName: manifest-example
```

# Injecting as a Volume



```
apiVersion: batch/v1
kind: Job
metadata:
  name: cm-vol-example
spec:
  template:
    spec:
      containers:
      - name: mypod
        image: alpine:latest
        command: ["/bin/sh", "-c"]
        args: ["cat /myconfig/city"]
        volumeMounts:
        - name: config-volume
          mountPath: /myconfig
      restartPolicy: Never
    volumes:
    - name: config-volume
      configMap:
        name: manifest-example
```

```
apiVersion: batch/v1
kind: Job
metadata:
  name: secret-vol-example
spec:
  template:
    spec:
      containers:
      - name: mypod
        image: alpine:latest
        command: ["/bin/sh", "-c"]
        args: ["cat /mysecret/username"]
        volumeMounts:
        - name: secret-volume
          mountPath: /mysecret
      restartPolicy: Never
    volumes:
    - name: secret-volume
      secret:
        secretName: manifest-example
```

# Hands-on: Using ConfigMaps & Secrets



<https://github.com/caifti/k8s-intro-tutorials/tree/master/configuration>



**Where to go  
From Here**

# kubernetes.io



<https://kubernetes.io/>

Documentation

Examples

API Reference

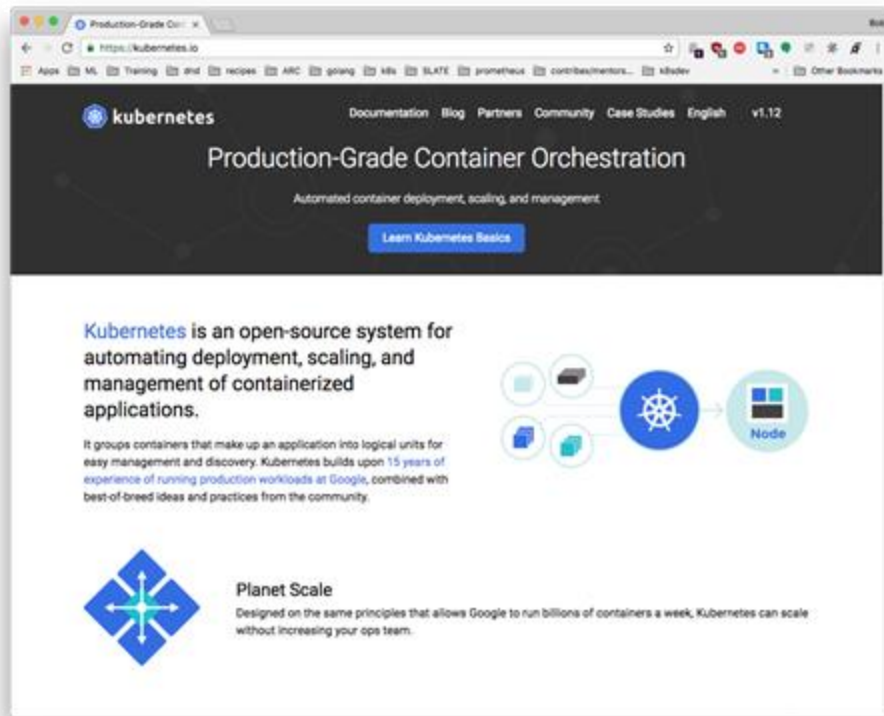



# Slack



## Kubernetes

[slack.k8s.io](https://slack.k8s.io)



70,000+ users  
300+ public channels

## CNCF

[slack.cncf.io](https://slack.cncf.io)



8,200+ users  
70+ public channels

# Other Communities



- **Official Forum**

<https://discuss.kubernetes.io>

- **Subreddit**

<https://reddit.com/r/kubernetes>

- **StackOverflow**

<https://stackoverflow.com/questions/tagged/kubernetes>



# Meetups



## Kubernetes

[meetup.com/topics/kubernetes/](https://meetup.com/topics/kubernetes/)



850+ groups

380,000+ members

## CNCF

[meetups.cncf.io](https://meetups.cncf.io)



200+ groups

120,000+ members

45+ countries

# Conventions



**KubeCon**



**CloudNativeCon**

**North America:**  
November 18 - 21, 2019  
San Diego, CA

**Europe:**  
March 30 – April 2, 2020  
Amsterdam, Netherlands

**Europe:**  
May 4 – 7, 2021  
Virtual

# GitHub



## Kubernetes

Kubernetes  
https://kubernetes.io

Repositories: 86 | People: 888 | Teams: 888 | Projects: 2

Pinned repositories

- kubernetes**  
Production-Grade Container Scheduling and Management  
Go 42.2k 1.2k
- features**  
Features tracking repo for Kubernetes releases  
Go 801 175
- community**  
Kubernetes community content  
Go 2.2k 1.1k
- website**  
Kubernetes website and documentation repo  
HTML 701 3.3k
- test-infra**  
Test infrastructure for the Kubernetes project.  
Go 627 672
- examples**  
Kubernetes application example tutorials  
Shell 1.2k 628

Search repositories... Type: All Language: All

- kube-state-metrics**  
Add-on agent to generate and expose cluster-level metrics.  
Go 488 286 Apache 2.0 Updated 10 minutes ago
- client-go**  
Go client for Kubernetes.  
Go 1.35k 838 Apache 2.0 Updated 10 minutes ago
- kubernetes**  
Production-Grade Container Scheduling and Management  
containers kubernetes go cncf  
Go 42.2k 11.8k Apache 2.0 44 issues need help Updated 42 minutes ago
- apiserver**  
Library for writing a Kubernetes-style API server.

Top languages  
Go HTML Shell Python JavaScript

Most used topics  
kubernetes k8s-staging containers cncf go

People 664

## kubernetes / kubernetes

View Repository | Watch 2,747 | Unstar 42,216 | Fork 14,648

Code | Issues 2,209 | Pull requests 960 | Projects 12 | Insights

Filters - Issue is open | Labels | Milestones | [New Issue](#)

2,209 Open | 25,184 Closed | Author | Labels | Projects | Milestones | Assignee | Sort

- kubectl should accept --to-revision option** [sig/api-machinery](#)  
#69461 opened an hour ago by PierluigiLancini
- Per service readiness probe** [kind/feature](#) [needs-sig](#)  
#69458 opened 4 hours ago by calind
- pr:pull-kubernetes-typecheck flaked 20 times in the past week** [needs-sig](#)  
#69457 opened 6 hours ago by fejta-bot
- Sample network policy is very unstable** [kind/bug](#) [sig/network](#)  
#69455 opened 7 hours ago by marcin-kawinski
- kubectl diff segfaults when the object doesn't exist** [kind/bug](#) [needs-sig](#)  
#69450 opened 14 hours ago by smalennikov
- New field in Pod spec cause issues with DaemonSet** [kind/bug](#) [sig/apps](#)  
#69445 opened 16 hours ago by mortart
- Failing/Flaking Test: E2E: [sig-autoscaling] [HPA] Horizontal pod autoscaling (scale resource: CPU) [sig-autoscaling] [Serial] [Slow] ReplicationController Should scale from 5 pods to 3 pods and from 3 to 1 and verify decision stability** [kind/flaking-test](#) [kind/flake](#) [priority/maintain-test](#) [sig/autoscaling](#)  
#69444 opened 16 hours ago by jberkus
- AWS EBS volume resize is not idempotent** [kind/bug](#) [sig/aws](#) [sig/storage](#)  
#69434 opened 20 hours ago by leaktapan
- DUMMY issue / testing automation** [kind/bug](#) [lifecycle/frozen](#) [priority/backlog](#) [sig/aws](#) [sig/cloud-provider](#) [sig/testing](#)  
#69429 opened 23 hours ago by nikoon
- Add an autoscaling step before cool off number for replicas in an hpa** [kind/feature](#) [sig/autoscaling](#)  
#69428 opened 23 hours ago by ranveeh00

# SIGs



- Kubernetes components and features are broken down into smaller self-managed communities known as **Special Interest Groups (SIG)**.
- Hold weekly public recorded meetings and have their own mailing lists and slack channels.

# SIG List

API Machinery	Apps	Architecture	Auth	Autoscaling	CLI
Cloud Provider	Cluster Lifecycle	Contributor Experience	Docs	Instrumentation	Multicluster
Network	Node	Product Management	Release	Scalability	Scheduling
Service Catalog	Storage	Testing	UI	Usability	Windows

# Working Groups



- Similar to SIGs, but are topic focused, time-bounded, or act as a focal point for cross-sig coordination.
- Hold scheduled publicly recorded meetings in addition to having their own mailing lists and slack channels.



# WG List

**Apply**

**Componet  
Standard**

**IoT Edge**

**K8s Infra**

**LTS**

**Machine  
Learning**

**Multitenancy**

**Policy**

**Resource  
Management**

**Security  
Audit**

# Links



- **Free Kubernetes Courses**  
<https://www.edx.org/>
- **Interactive Kubernetes Tutorials**  
<https://www.katacoda.com/courses/kubernetes>
- **Learn Kubernetes the Hard Way**  
<https://github.com/kelseyhightower/kubernetes-the-hard-way>
- **Official Kubernetes Youtube Channel**  
<https://www.youtube.com/c/KubernetesCommunity>
- **Official CNCF Youtube Channel**  
<https://www.youtube.com/c/cloudnativefdn>
- **Track to becoming a CKA/CKAD (Certified Kubernetes Administrator/Application Developer)**  
<https://www.cncf.io/certification/expert/>
- **Awesome Kubernetes**  
<https://ramitsurana.gitbooks.io/awesome-kubernetes/content/>



# Other learning resources



- **Techworld with Nana - Kubernetes course**  
<https://www.youtube.com/playlist?list=PLY7NrYWoggziYQIDorIXjTvwwweTYoNC>
- **Container (K8s) networking explained**  
[https://www.youtube.com/watch?v=6v\\_BDHlgOY8](https://www.youtube.com/watch?v=6v_BDHlgOY8)
- **OLSS demo app**  
<https://github.com/andreaceccanti/olss-demo-app>



**Questions?**