



TOTEM and DØ: the discovery of the Odderon

E. Bossini^{1,2},

on behalf of the TOTEM collaboration

20/05/2021

¹ Università di Pisa, Italy

² INFN – Pisa Section, Italy

Outline



- Theoretical background
- TOTEM experimental setup
- Odderon discovery:
 - Cross section measurements
 - ρ and CNI region
 - $pp/p\bar{p}$ data comparison with DØ
- Run 3 and conclusions

Diffractive physics



Non-diffractive

- Exchange of quantum numbers possible
- Rapidity gaps exponentially suppressed

$$dN/d\Delta\eta \sim e^{-\Delta\eta}$$

Incident hadrons acquire color and break apart

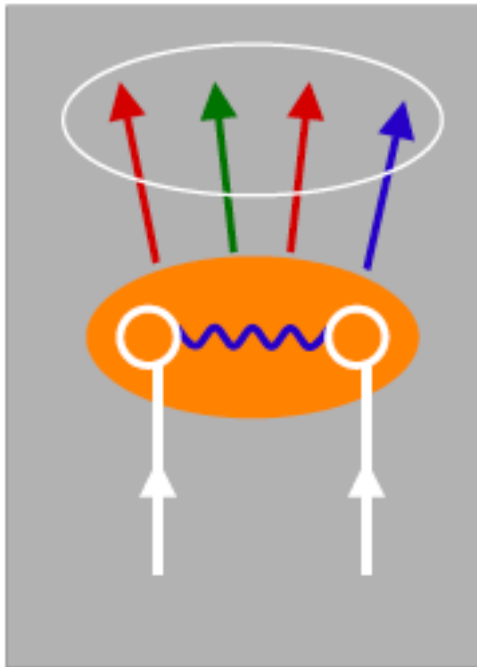

$$\eta = -\ln \tan(\theta/2), \quad (|p_{\perp}| \gg m)$$

Diffractive

- No exchange of quantum number \rightarrow no color exchange
- Rapidity gaps constant

$$dN/d\Delta\eta \sim \text{const}$$

Rapidity gap

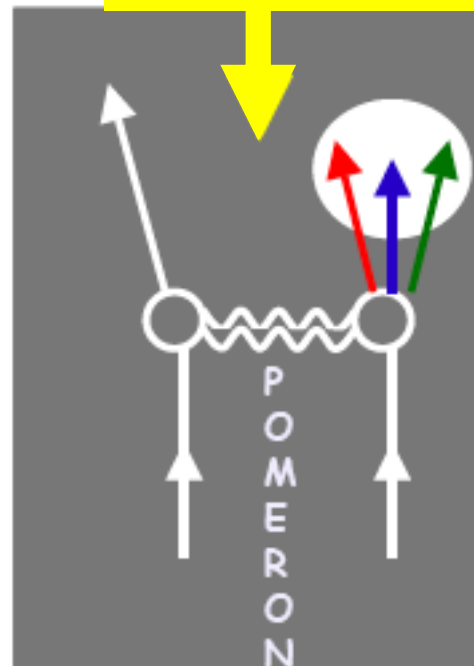

One or both hadrons can survive the interaction (i.e. elastic scattering).

At low $|t|$ (soft diffraction) pQCD cannot be applied, but Regge phenomenological model can describe the data.

Diffraction is modeled as an exchange of one or more "objects" or "trajectories" with vacuum quantum number. The leading trajectory is called Pomeron.

Notes on Regge framework

The Pomeron was first introduced during 60' in the Regge theory framework[1].

$$A_{el}(s, t) \sim - \sum_{\xi=\pm 1} \sum_i \beta_i(t) \frac{1 + \xi e^{-i\pi\alpha_i(t)}}{\sin \pi\alpha_i(t)} s^{\alpha_i(t)}$$

$\alpha_i(t)$ represents a trajectory (Reggeon) in the complex plane which interpolates the poles ($\alpha_i(t)=j$, j integer) of the scattering amplitude.

The poles identify resonances and bound state of increasing $j \rightarrow$ **A Reggeon is an exchange of a family of resonances with same quantum numbers.**

In the high energy limit ($s \rightarrow \infty$) $A_{el}(s, t)$ depends only on the leading pole $\alpha(t)$

Adding the Optical Theorem in the high energy limit:

$$\sigma_{tot} \cong \frac{1}{s} \text{Im} A_{el}(s, t = 0) \quad \longrightarrow \quad \sigma_{tot} \sim s^{\alpha(0)-1}$$

All known Reggeons have intercept below 1 \rightarrow Pomeron ($C=P=1$) introduced as the dominant trajectory with intercept above 1 to explain the observed increased with energy of hadronic cross sections

Fit on a large dataset of pp and $p\bar{p}$ give a value for intercept $\alpha(0) \sim 1.08$ (Donnachie-Landshoff [2])

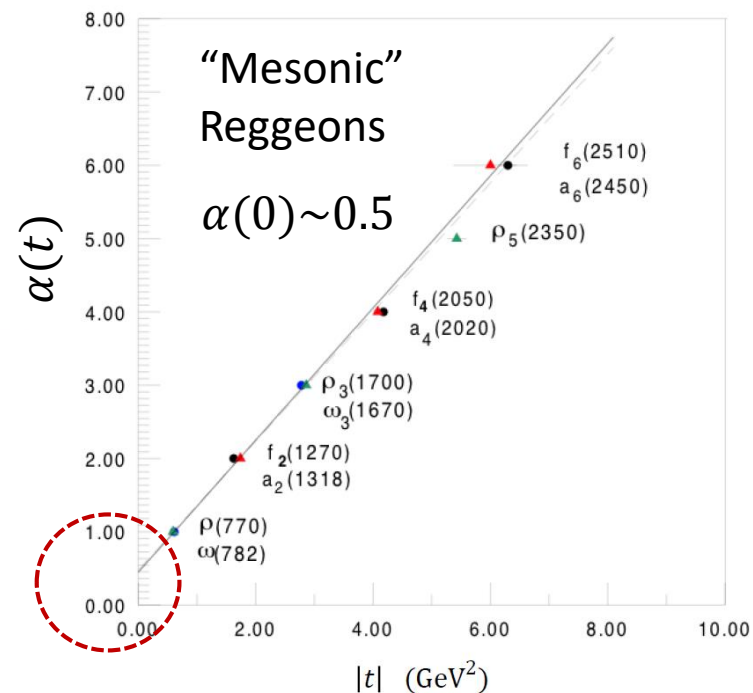

Odderon



The Odderon is an interesting but elusive object. Its history goes back to 1973 when the possible contribution of an C-odd exchange in very high energy collisions was first studied[3].

The Odderon is the C-odd partner of the Pomeron, with intercept close to one. The Odderon existence is also a fundamental prediction of pQCD, where it is represented (in the most basic form) by the exchange of a **colourless 3-gluon bound state** in the t-channel. Such a state would have $JPC=1--$ quantum numbers and is predicted by lattice QCD with a mass of about 3 to 4 GeV (also referred to as **vector glueball**[4]).

Several contributions[5] to the QCD Odderon have been developed to include higher order corrections:

- Bartels ,Kwiecinski & Praszalowicz [6,7] -> BKP equation, generalization of BFKL equation
- Janik & Wosiek [8]
- Bartels, Lipatov & Vacca [9]
- ...

The Odderon considered as a complex exchange of three “reggeized gluons”. The name come from the gluon propagator, which shows an energy dependence of the type $s^{\epsilon(t)}$ [1,5]

Odderon effects are subdominant to the Pomeron (double gluon exchange in pQCD) -> need to investigate regions where Pomeron exchange contribution is small or where crossing-odd properties can emerge.

Odderon effect on ρ - σ_{tot} relation

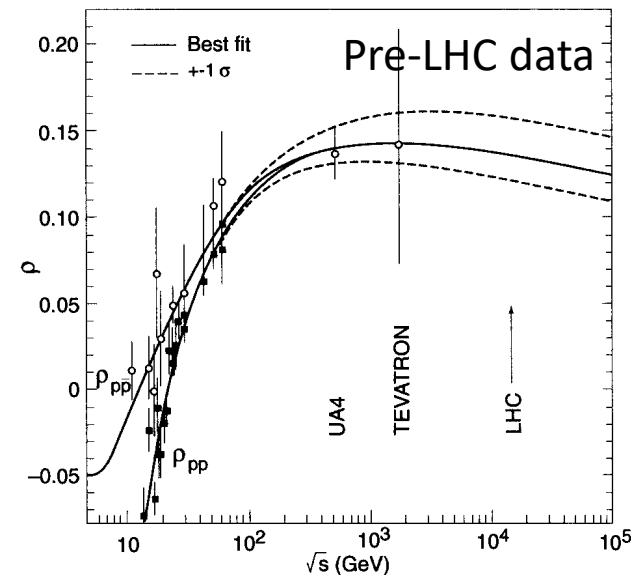
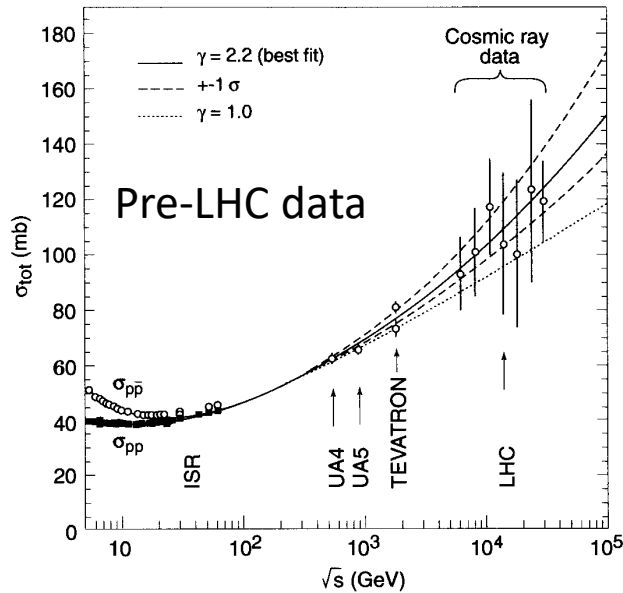

More sensitive to the Odderon exchange than the cross section is the ρ parameter:

$$\rho = \frac{\text{Re } A(s, t)}{\text{Im } A(s, t)} \Big|_{t=0}$$

While Optical theorem relates $\text{Im } A(s, 0)$ and σ_{tot} , general analyticity and crossing properties relate the real and the imaginary parts through dispersion relations.

Was demonstrated (Bronzan, Kane and Sukhatme [10]) that the crossing-even part of ρ can be expressed as

$$\rho^+ \cong \frac{\pi}{2\sigma_{tot}^+} \frac{d\sigma_{tot}^+}{d \ln s}$$



Deviation from this relation at LHC energy, where mesonic reggeons contribution are negligible, represents a hint for a non vanishing crossing-odd contribution, the Odderon.

The contribution of the Odderon to the $\text{Re } A(s, t)$ generate a value of ρ deviating from predictions

Differential elastic cross section

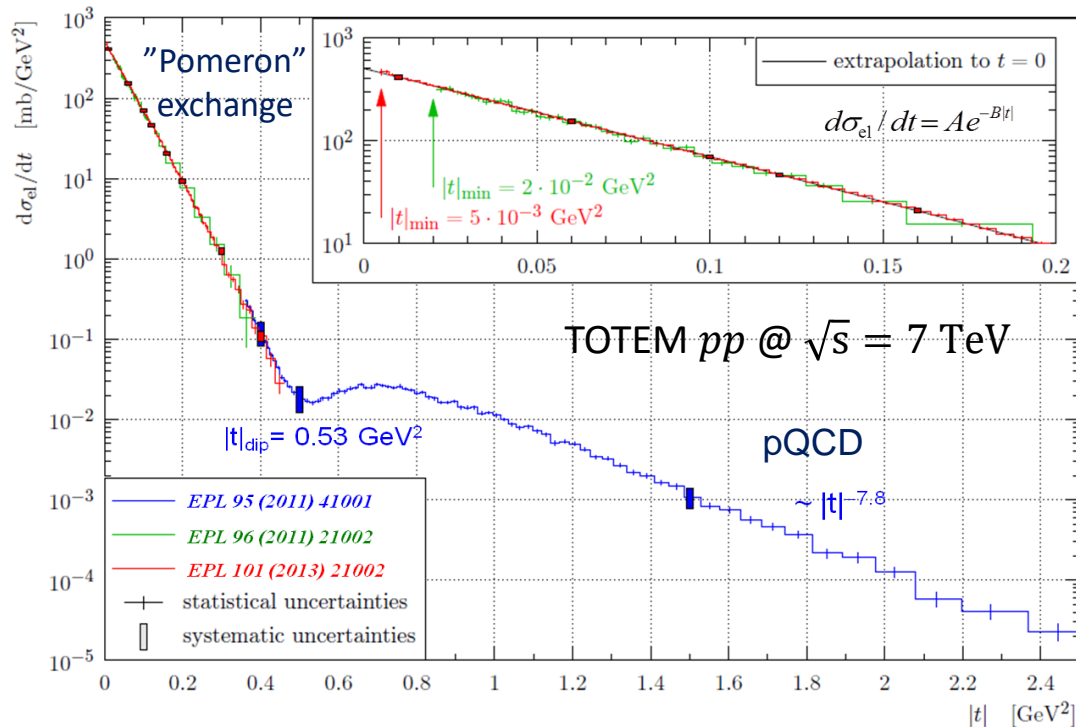

Main features of the elastic differential cross section:

- Forward peak with exponential behavior (at first approximation)
- Shrinkage of the forward peak with energy, well described by Regge theory with no analogues in optical diffraction
- Dip and bump structure (pp) or shoulder ($p\bar{p}$)
- $\sim |t|^{-8}$ behaviour at larger $|t|$ (as per pQCD prediction dominated by the exchange of 3 free gluons)

The dip can be described as the $|t|$ -range where $\text{Im } A(s, t)$ is crossing zero, thus ceding the dominance to the real part to which a 3-gluon exchange contributes.

- The cross-odd behaviour of the Odderon leads to a different dip-bump structure un pp and $p\bar{p}$ data.
- At lower (ISR) energies the difference can be due to the mesonic Reggeons contributions

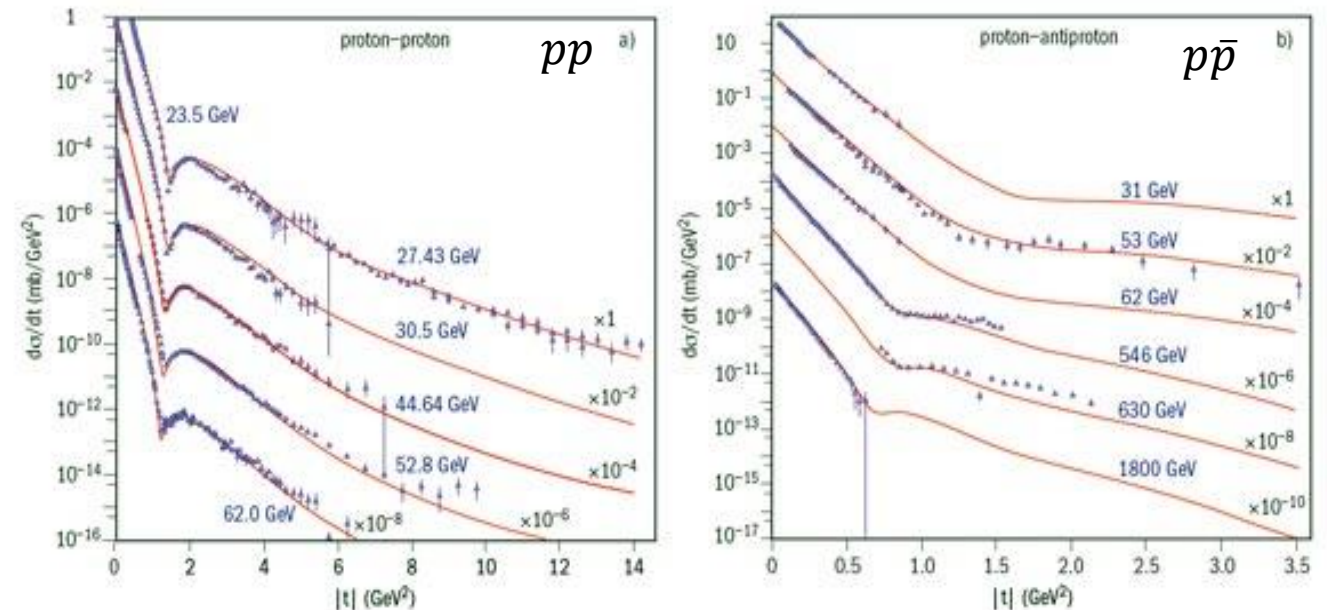

The TOTEM Experiment

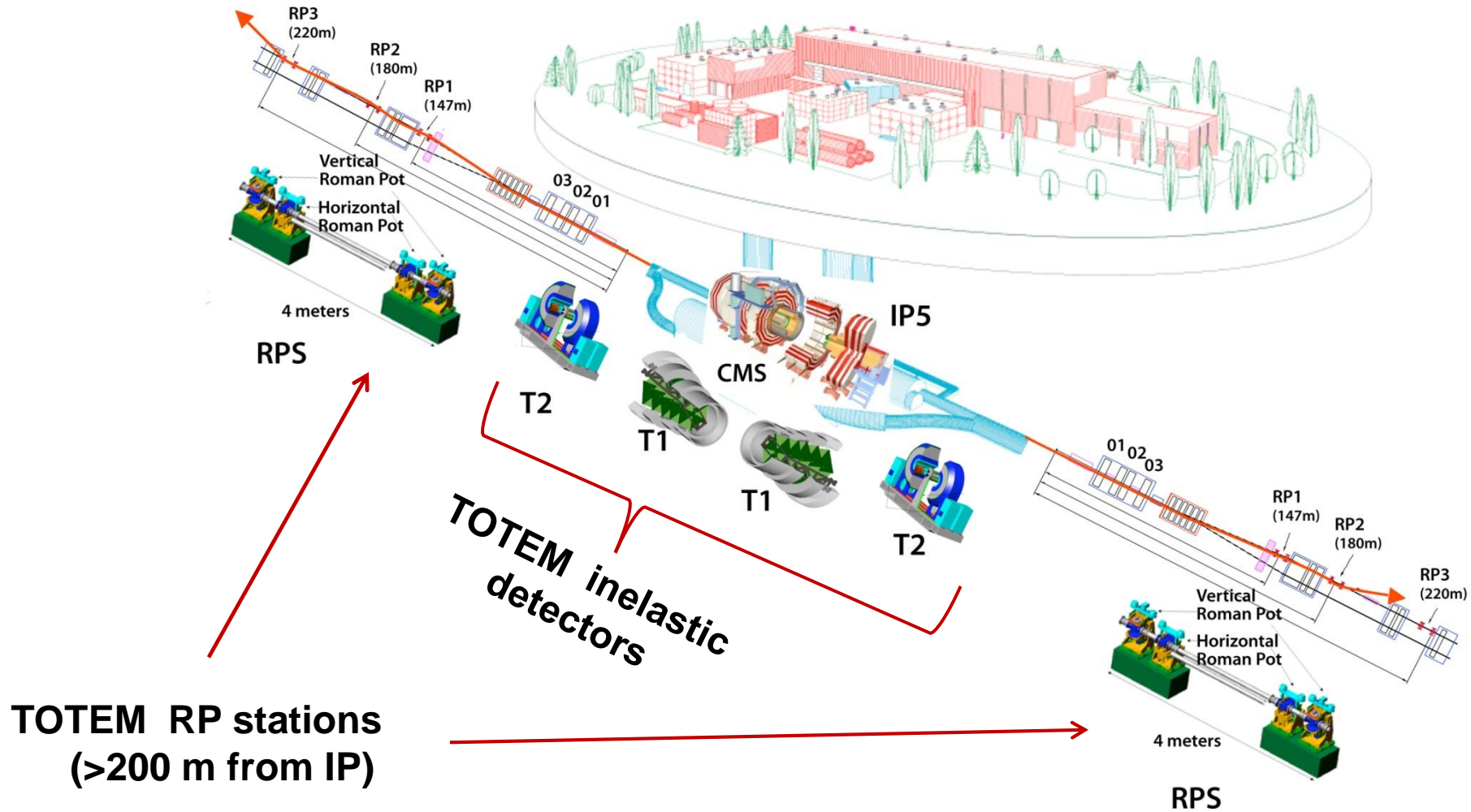

Inelastic telescope T1

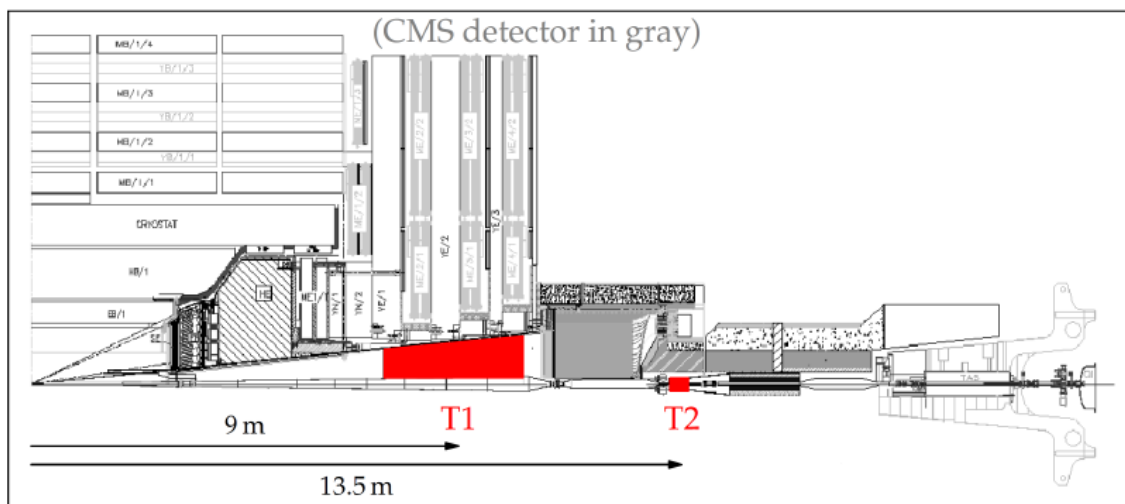

$3.1 < |\eta| < 4.7$, 7.5 m from IP:

- installed in two cone-shaped regions in front of CMS HF
- 5 equally spaced planes of six trapezoidal Cathode Strip Chambers (CSC)
- strips placed on both sides of the chamber, with different angles of 60° with respect to the orientation of the anodic wires
- the orientations of the cathode strips and of the anode wires allow three measurements for each particle track.
- spatial resolution of about 1 mm in the three coordinates, with an overall detection and reconstruction efficiency of 98% and trigger capabilities.

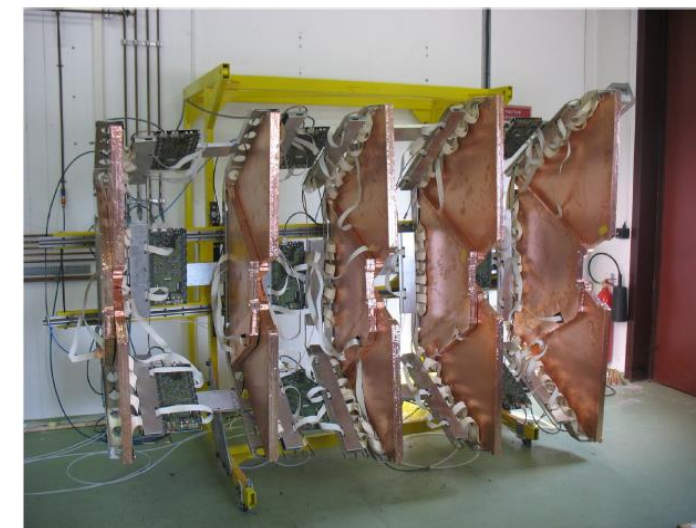

Inelastic telescope T2

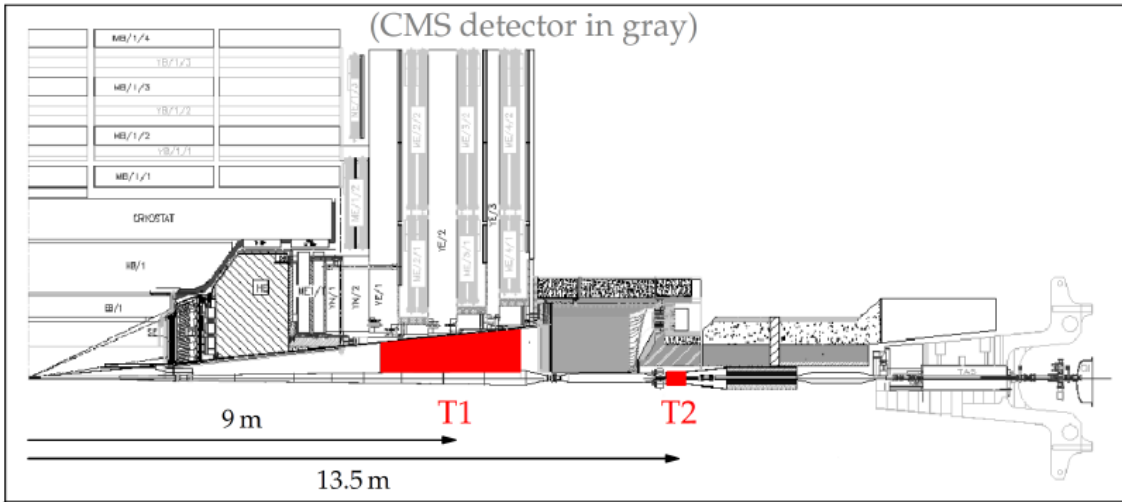

$5.3 < |\eta| < 6.5$ (not instrumented by CMS), 13.5 m from IP:

- 20 almost semi-circular triple Gas Electron Multiplier (GEM) detectors per arm
- Readout is realized with a multi-layer PCB, with patterns of strips and pads.
- The strip pattern, made with 256 concentric strips, measures the radial coordinate with $100 \mu\text{m}$ resolution.
- Provides a fully inclusive trigger on inelastic events
- Used to perform precise measurements of the forward charged particle pseudorapidity density at $\sqrt{s} = 7 \text{ TeV}$ (TOTEM only[11]) and $\sqrt{s} = 8 \text{ TeV}$ (with CMS[12])

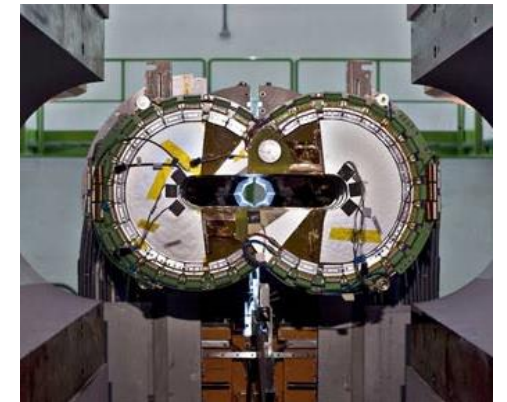
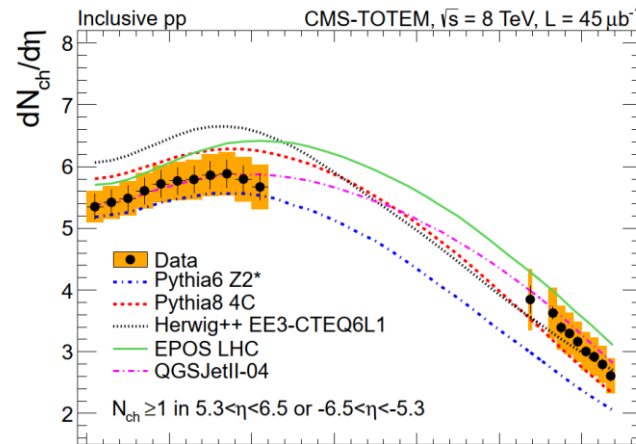
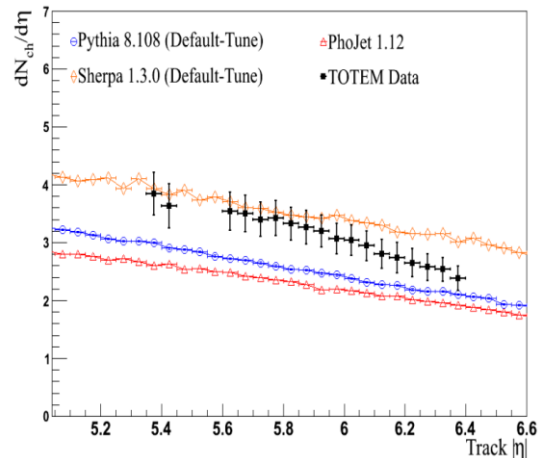

Proton tagging with Roman Pots (RP)



Not in scale

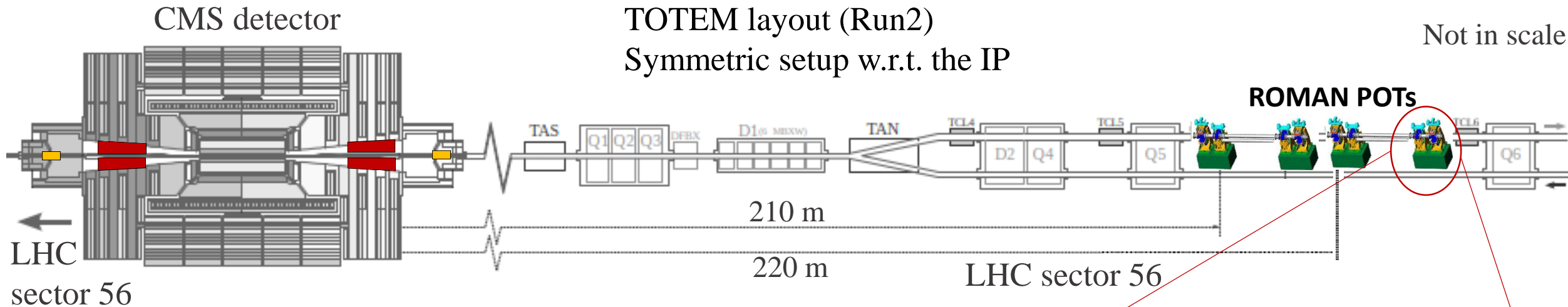

- Vacuum vessel entering the beam pipe, can be equipped with many types of detectors.
- Hosted detectors brought to few mm from the beam in a secondary vacuum.
- Scattered protons with very-low $|t|$ can be detected
- Standard units composed of 3 RPs (2 verticals, 1 horizontal)

- Different types of detector hosted during Run2:
 - Tracking strip for TOTEM/CMS
 - Tracking pixel for CMS
 - Timing UFSD for TOTEM
 - Timing diamond for CMS

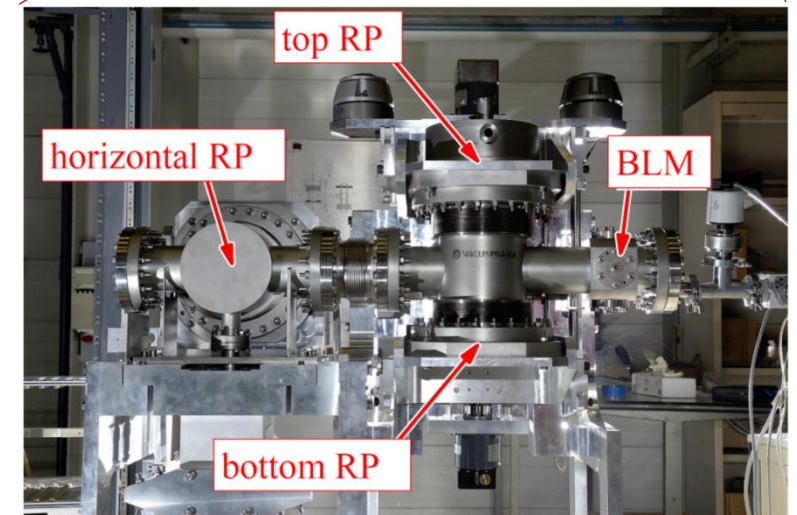

RP unit

Proton tagging with Roman Pots



Not in scale

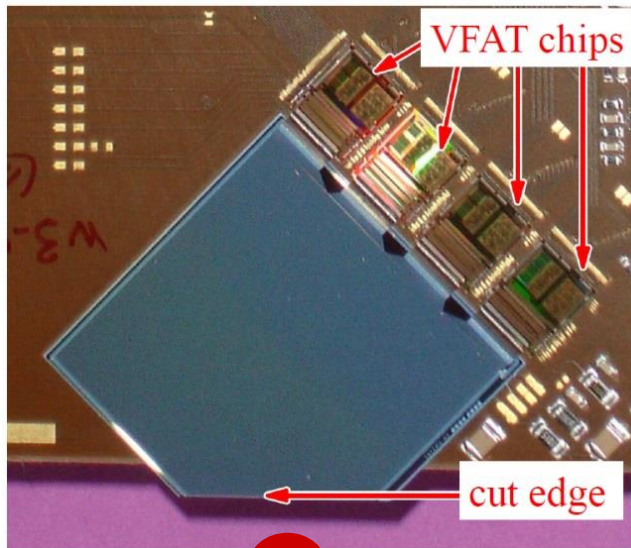
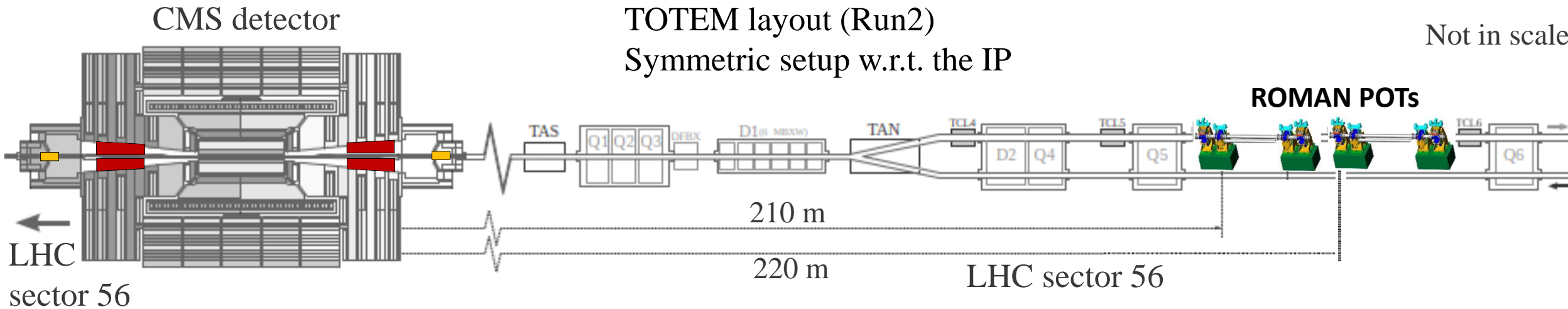

LHC beam

- TOTEM uses silicon strip detectors for tracking
- 10 planes per pot in back to back configuration, 512 edgeless Si strips each
- Designed to reach the lowest $|t|$ (edgeless tech.)
- Spatial resolution $\sim 10 \mu\text{m}$
- Overlap of the tracker sensitive area used for relative alignment
- Clusters of 16 strips used to provide trigger information

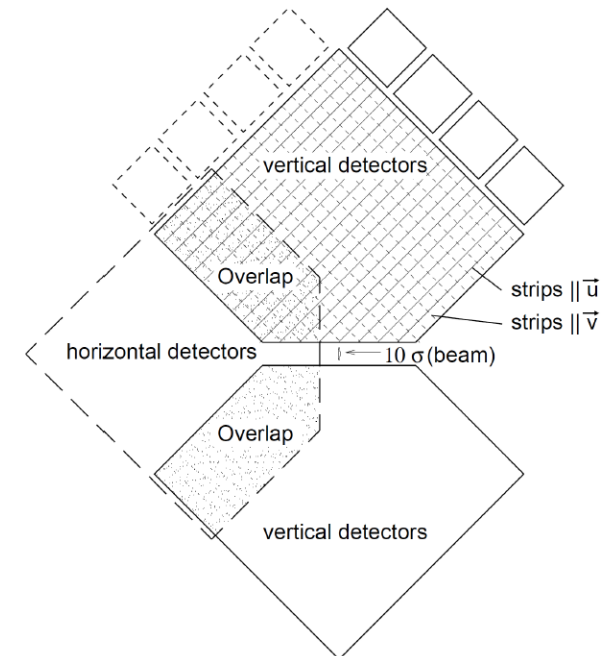

Proton kinematics

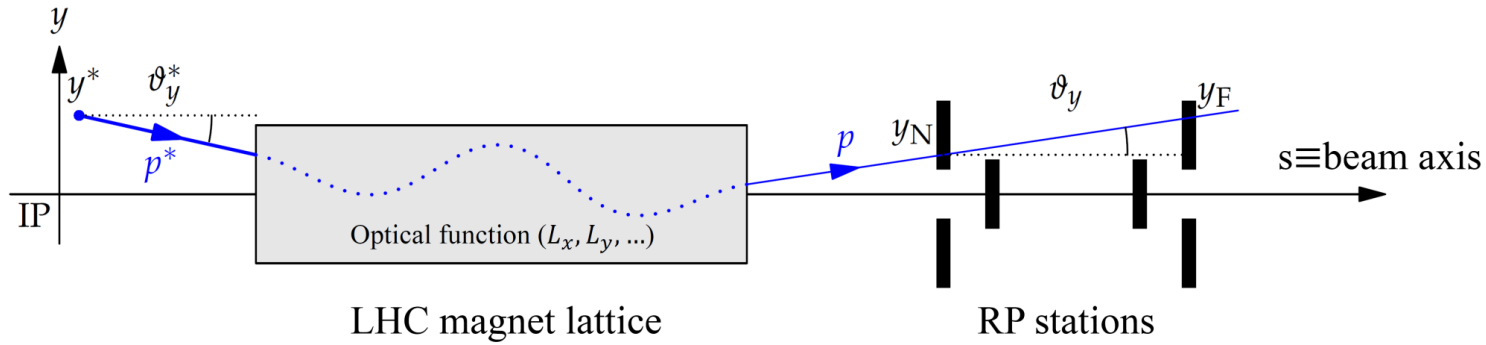

Two RP units, separated by ~5 m, are used as a triple spectrometer. They can measure the local angle and position of the protons.

$$\mathbf{d}^*: (x^*, y^*, \theta_x^*, \theta_y^*, \xi) \longrightarrow \mathbf{d}: (x, y, \theta_x, \theta_y, \xi)$$

$$\mathbf{d}(s) = T(s, \xi) \mathbf{d}^*$$

Hit distribution on detectors determined by the optics.

$$\begin{pmatrix} x \\ \theta_x \\ y \\ \theta_y \\ \xi \end{pmatrix} = \begin{pmatrix} v_x & L_x & 0 & 0 & D_x \\ \frac{dv_x}{ds} & \frac{dL_x}{ds} & 0 & 0 & \frac{dD_x}{ds} \\ 0 & 0 & v_y & L_y & D_y \\ 0 & 0 & \frac{dv_y}{ds} & \frac{dL_y}{ds} & \frac{dD_y}{ds} \\ 0 & 0 & 0 & 0 & 1 \end{pmatrix} \begin{pmatrix} x^* \\ \theta_x^* \\ y^* \\ \theta_y^* \\ \xi \end{pmatrix}$$

$$\begin{aligned} t &\approx -p^2(\theta_x^{*2} + \theta_y^{*2}) \\ x &= L_x \theta_x^* + v_x x^* + D_x \xi \\ y &= L_y \theta_y^* + v_y y^* \\ \theta_x &= \frac{dv_x}{ds} x^* + \frac{dL_x}{ds} \theta_x^* \end{aligned}$$

Desired characteristics:

- Almost vanishing $v_{x,y}$ -> “parallel to point focusing”, impact point on the detector independent from vertex
- Large effective length -> Effect of detector resolution reduced
- Large β^* to reduce beam divergence -> low uncertainty on the initial scattering angle, lower $|t|$ reached.

L_x, L_y : effective lengths (sensitivity to scattering angle)

v_x, v_y : magnifications (sensitivity to vertex position)

D_x : dispersion (sensitivity to $\xi = \Delta p/p$), $D_y \sim 0$

Proton kinematics

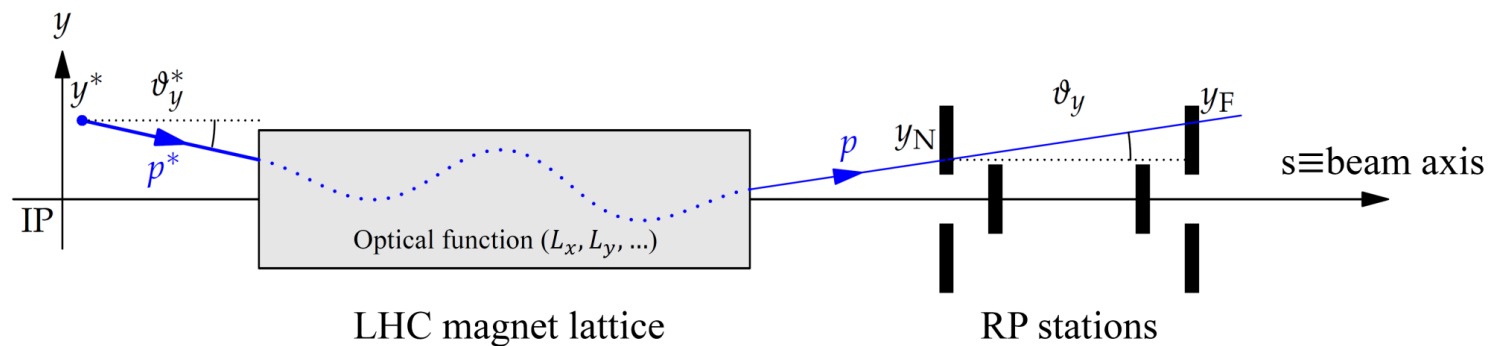

Two RP units, separated by ~ 5 m, are used as a triple spectrometer. They can measure the local angle and position of the protons.

$$\mathbf{d}^*: (x^*, y^*, \theta_x^*, \theta_y^*, \xi) \longrightarrow \mathbf{d}: (x, y, \theta_x, \theta_y, \xi)$$

$$\mathbf{d}(s) = T(s, \xi) \mathbf{d}^*$$

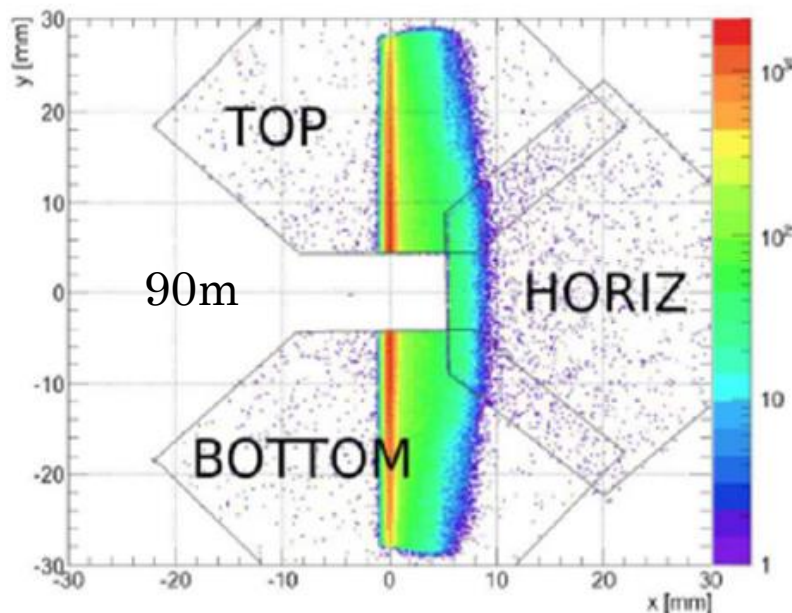

$\beta^* = 90\text{m}$:

- Low L_x , detector resolution impact $\sigma_{\theta_x^*}$
- Non elastic protons displaced in x position

$\beta^* = 1\text{km}, \quad \beta^* = 2.5\text{km}$:

- Larger L_x , better $\sigma_{\theta_x^*}$
- Lowest values of $|t|$ can be reached
- Low event rate

Parallel to point focusing fulfilled on vertical plane. Non elastic protons ($\xi \neq 0$) scattered at large x.

Elastic event selection



Only diagonal RP combinations can tag elastic events

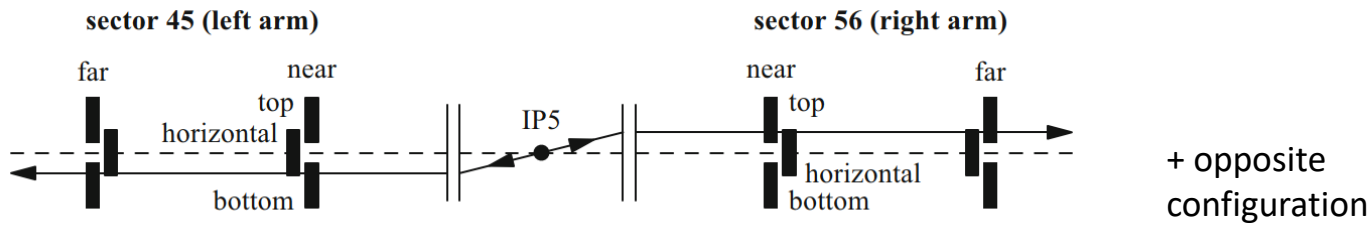

Further elastic selection is performed with the application of selection cuts, tuned with the data.

Discriminator	Cut quantity	
1	$\theta_x^{*R} - \theta_x^{*L}$	} Collinearity
2	$\theta_y^{*R} - \theta_y^{*L}$	
3	$\alpha y^{R,N} - (y^{R,F} - y^{R,N})$	} Angle/position correlation
4	$\alpha y^{L,N} - (y^{L,F} - y^{L,N})$	
5	$x^{*R} - x^{*L}$	} Vertex compatibility

Cuts 2-5 not always available:

- Angle/position correlation require two RP (near and far)
- Vertex reconstruction is effective only under particular optics

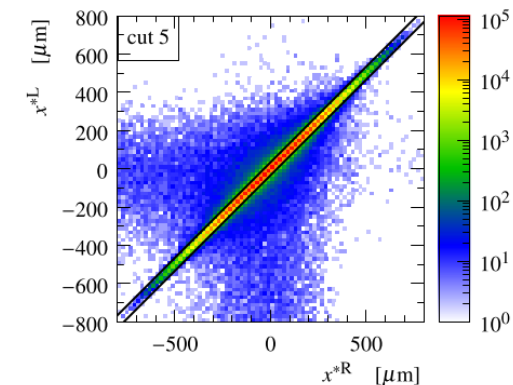
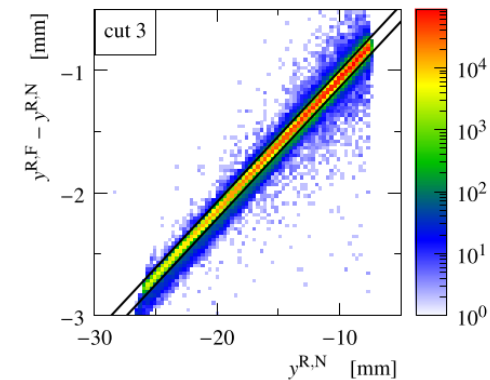
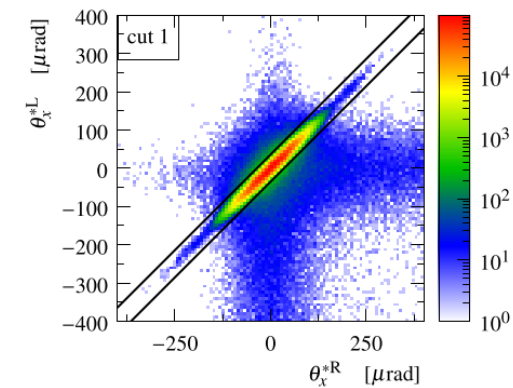

Background and acceptance



Background is evaluated in a double step procedure:

1. plot a cut discriminator under a combination of the other cuts. Reduction of tails is expected (solid lines)
2. background distribution is interpolated from the tails. The shape is inferred and cross-checked with non-diagonal sample (dashed line).

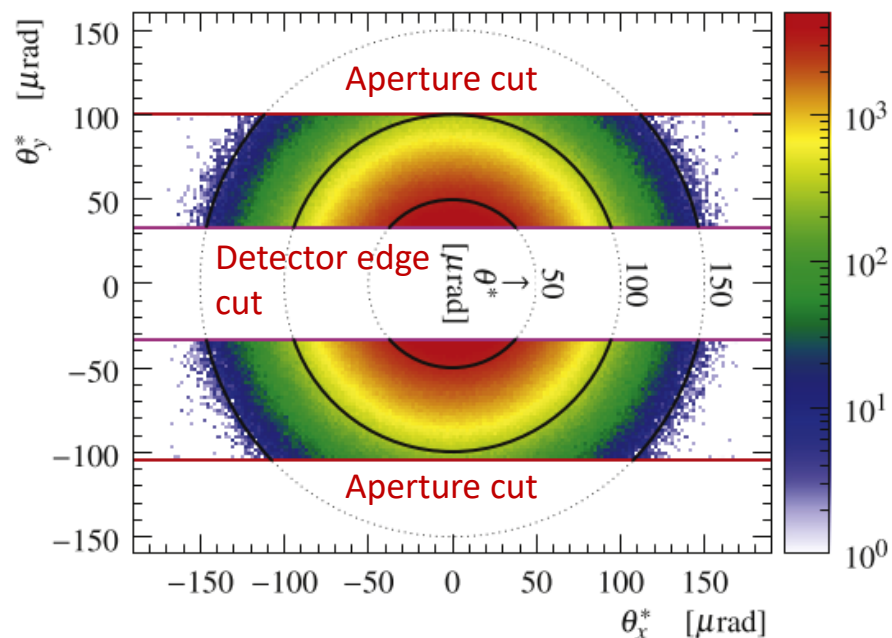
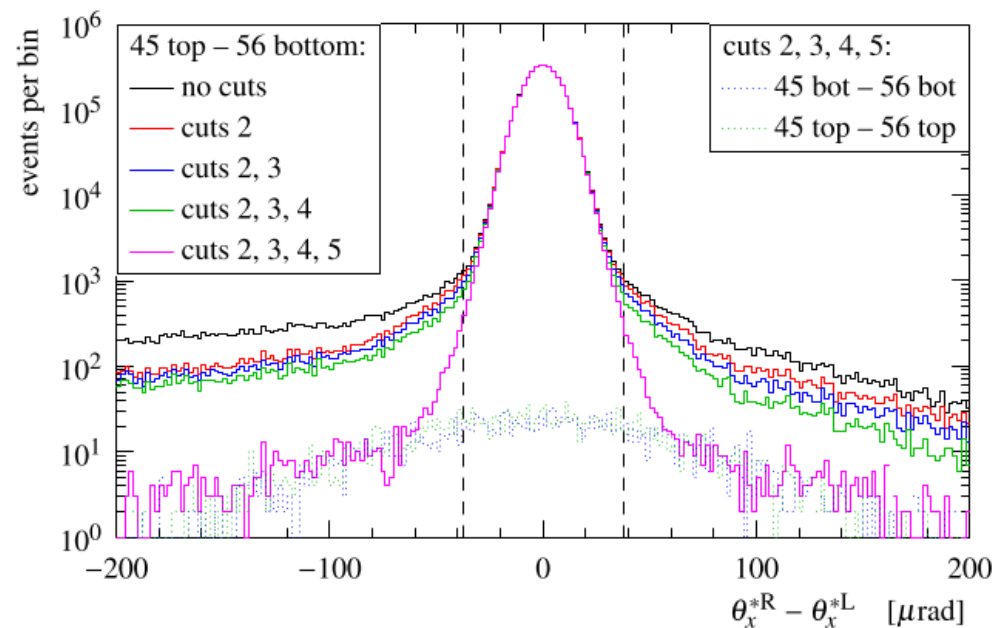

Acceptance corrections are computed exploiting the azimuthal symmetry of the protons. $|t|$ -values with correction above a given threshold are not used

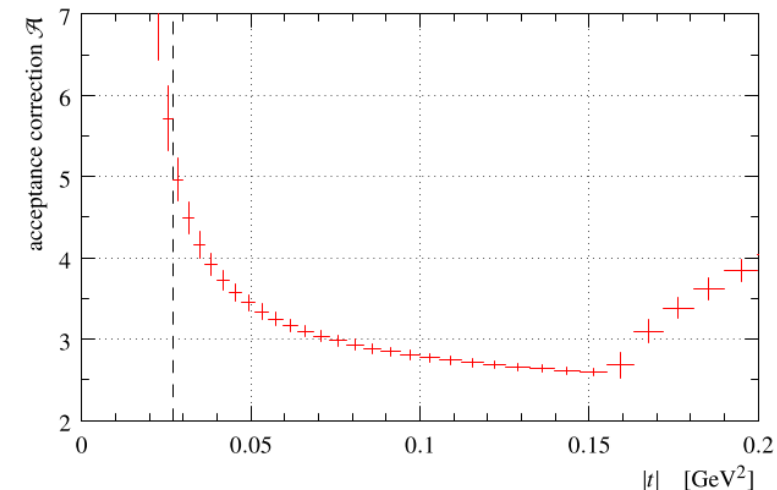

Total cross section measurements



*elastic observation only
(through Optical theorem)*

$$\sigma_{tot} = \frac{16\pi}{1 + \rho^2} \frac{1}{\mathcal{L}} \left. \frac{dN_{el}}{dt} \right|_{t=0}$$

- $dN_{el}/dt|_{t=0}$
- $\sigma_{el} \leftarrow dN_{el}/dt$ integr.
- Luminosity (from CMS)
- N_{inel} (from T1 & T2)
- ρ from COMPETE

σ_{tot}

ρ independent

$$\sigma_{tot} = \frac{1}{\mathcal{L}} (N_{el} + N_{inel})$$

From T1 & T2 data σ_{inel} can be directly measured

luminosity independent

$$\sigma_{tot} = \frac{16\pi}{1 + \rho^2} \frac{dN_{el}/dt|_{t=0}}{N_{el} + N_{inel}}$$

Preferred method due to the large uncertainty on \mathcal{L}

[13] Measurements at $\sqrt{s} = 7$ TeV

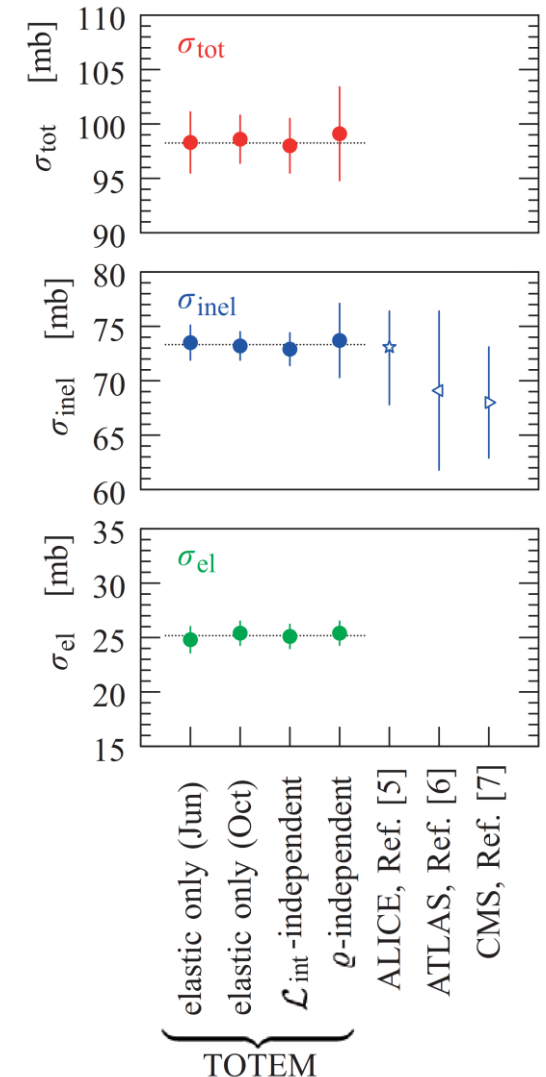

Total cross section measurements



- $dN_{el}/dt|_{t=0}$
- $\sigma_{el} \leftarrow dN_{el}/dt$ integ
- Luminosity (from CM)
- N_{inel} (from T1 & T2)
- ρ from COMPETE

ρ independent

$$\sigma_{tot} = \frac{1}{\mathcal{L}} (N_{el})$$

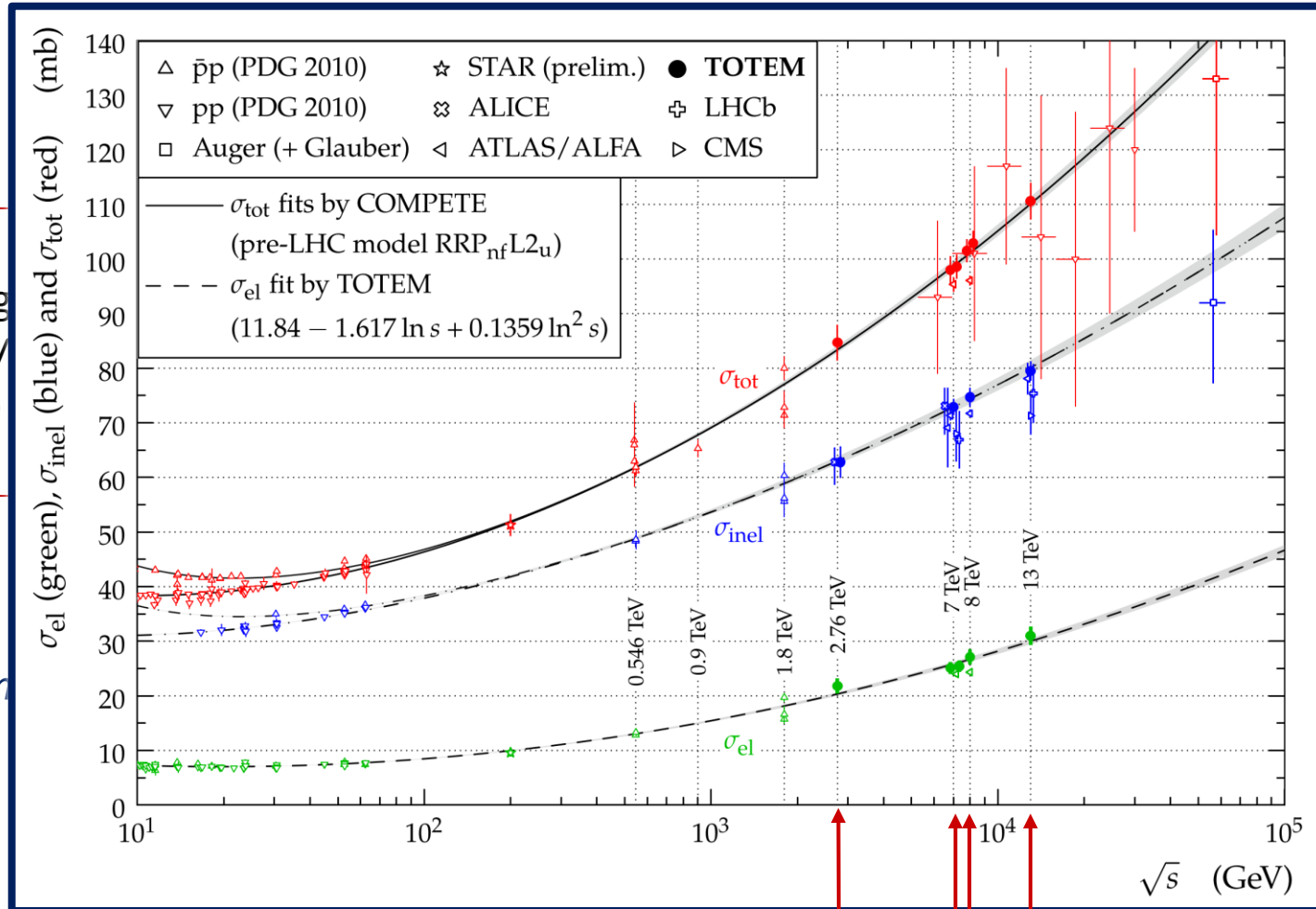

[13] Measurements at $\sqrt{s} = 7$ TeV

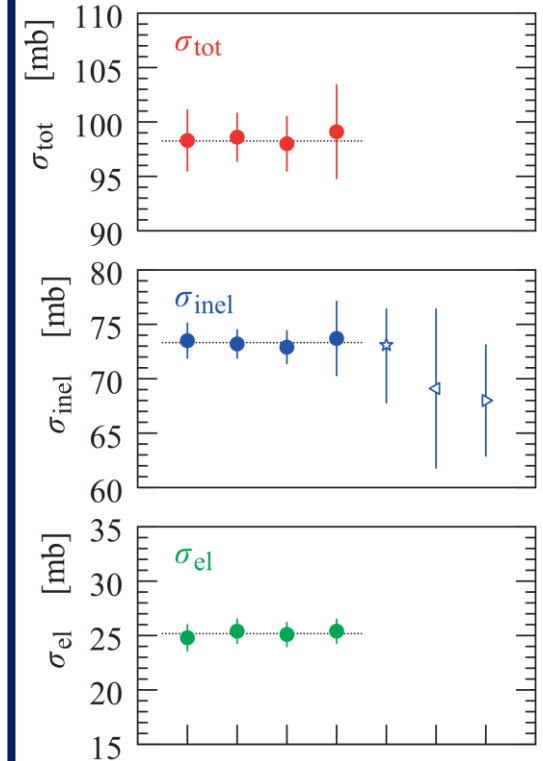

From T1 & T2 data σ_{inel} can be directly measured

σ_{tot} in agreement with COMPETE preferred model

2.76, 7, 8, 13 TeV [14]

elastic only (Jun)
 elastic only (Oct)
 \mathcal{L}_{int} -independent
 ρ -independent
 ALICE, Ref. [5]
 ATLAS, Ref. [6]
 CMS, Ref. [7]

TOTEM

Very low- $|t|$ range - CNI



At small enough $|t|$ the pp scattering is also affected by the Coulomb interaction. Need investigation of very low- t region ($|t| < 10^{-3} \text{ GeV}^2$).

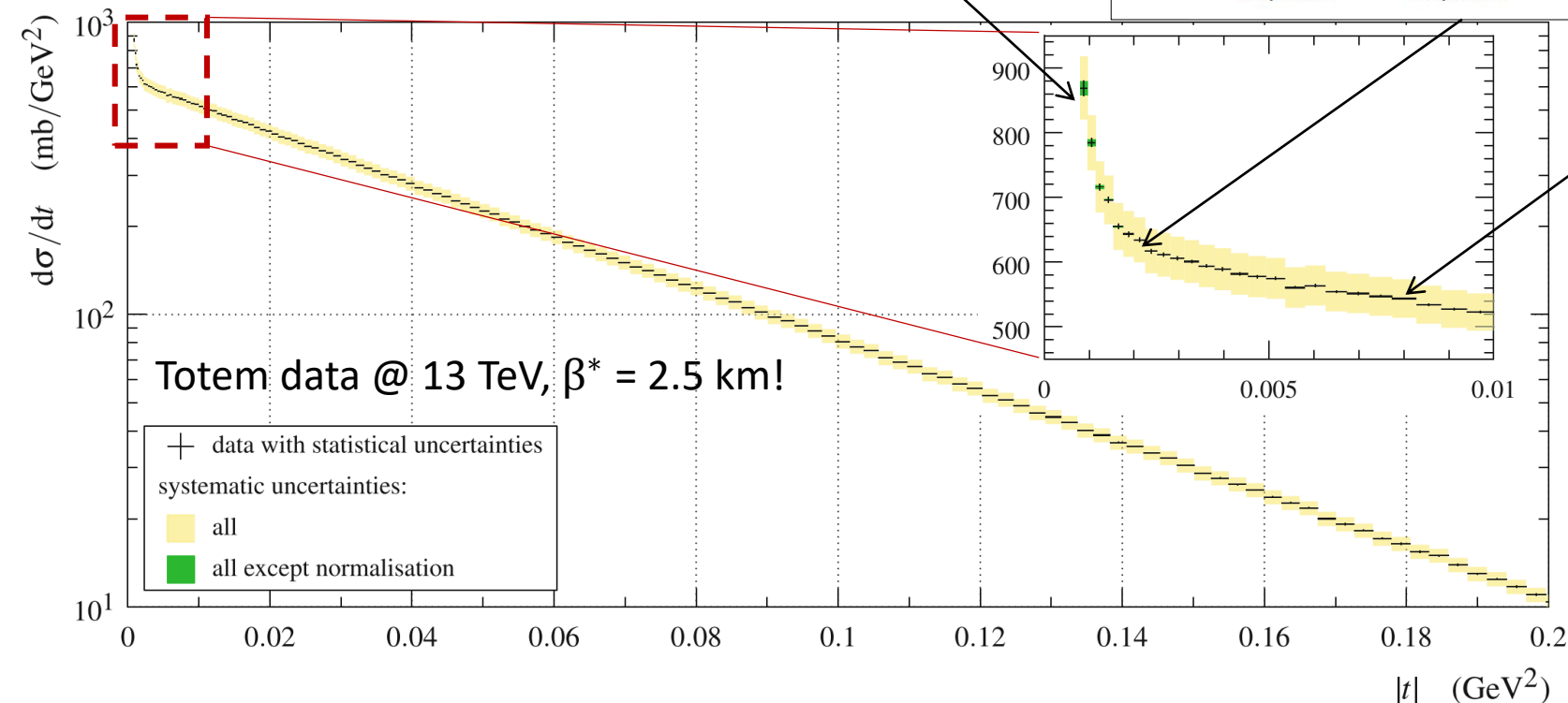
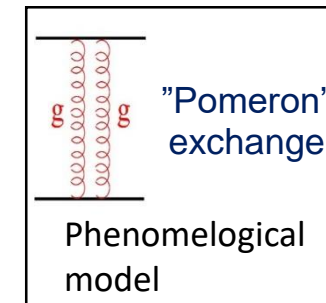
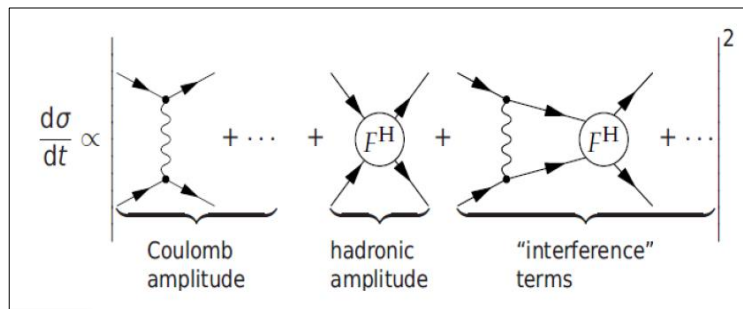
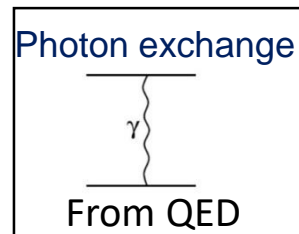

- Coulomb amplitude well known from QED
- Different phenomenological parametrizations for the other regimes:
 - Hadronic modulus
 - Hadronic phase
 - Interference formula

The $|t|$ region dominated by QED was used as an alternative independent way to normalize the data at 13 TeV. Final cross section in agreement with the one obtained with standard $\beta^* = 90\text{m}$ data.

Very low- $|t|$ range – CNI

➤ Hadronic modulus

$$|\mathcal{A}^N(t)| = \sqrt{\frac{s}{\pi}} \frac{p}{\hbar c} \sqrt{a} \exp\left(\frac{1}{2} \sum_{n=1}^{N_b} b_n t^n\right)$$

➤ Hadronic phase



- central phase {
- constant phase ($\arg \mathcal{A}^H(t) = \pi/2 - \arctan \rho$)
 - standard
 - Bailly
 - peripheral

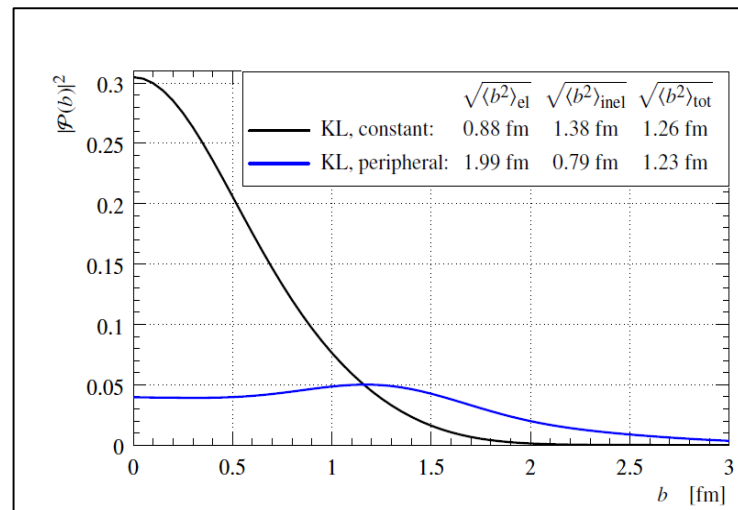

$\arg \mathcal{A}^N(t)$ determines the scattering amplitude in the impact parameter space

➤ CN Interference formula -> Contains explicit dependence from ρ

- Simplified West-Yenne SWY, traditionally used in the past at ISR, SppS, Tevatron (constant phase, $N_b=1$)
- Cahn (different phase/modulus can be used)
- KL (very similar to Cahn, adds integration limits on the momentum transfer)

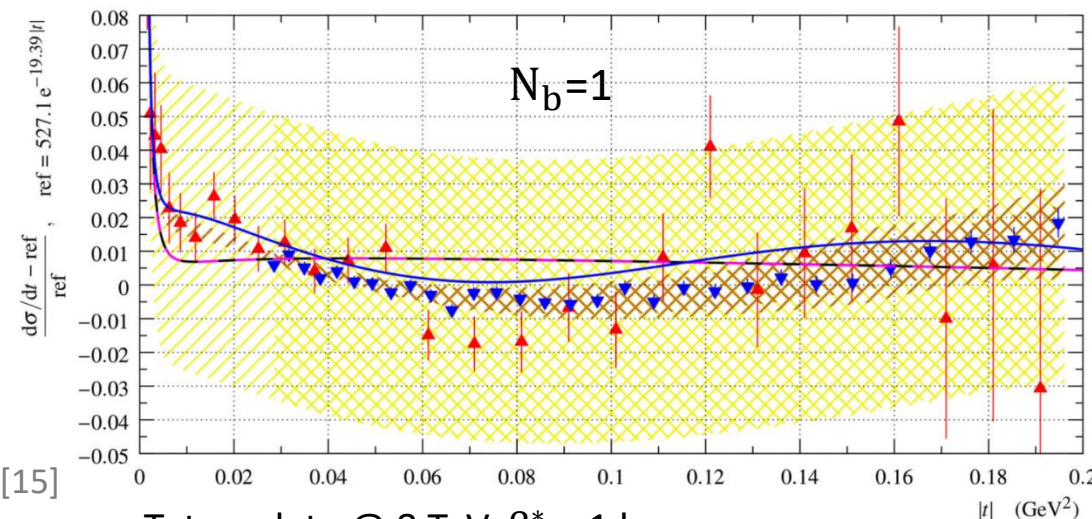
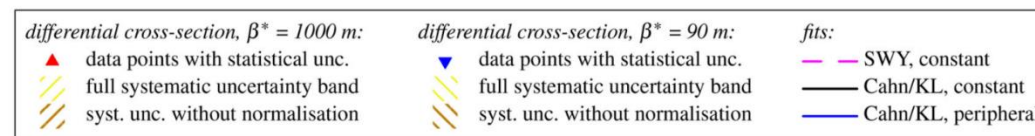

Totem data @ 8 TeV, $\beta^* = 1$ km

Analysis of 8 TeV data excluded SWY with more than 7σ significance [15]

ρ extrapolation – 8 TeV results

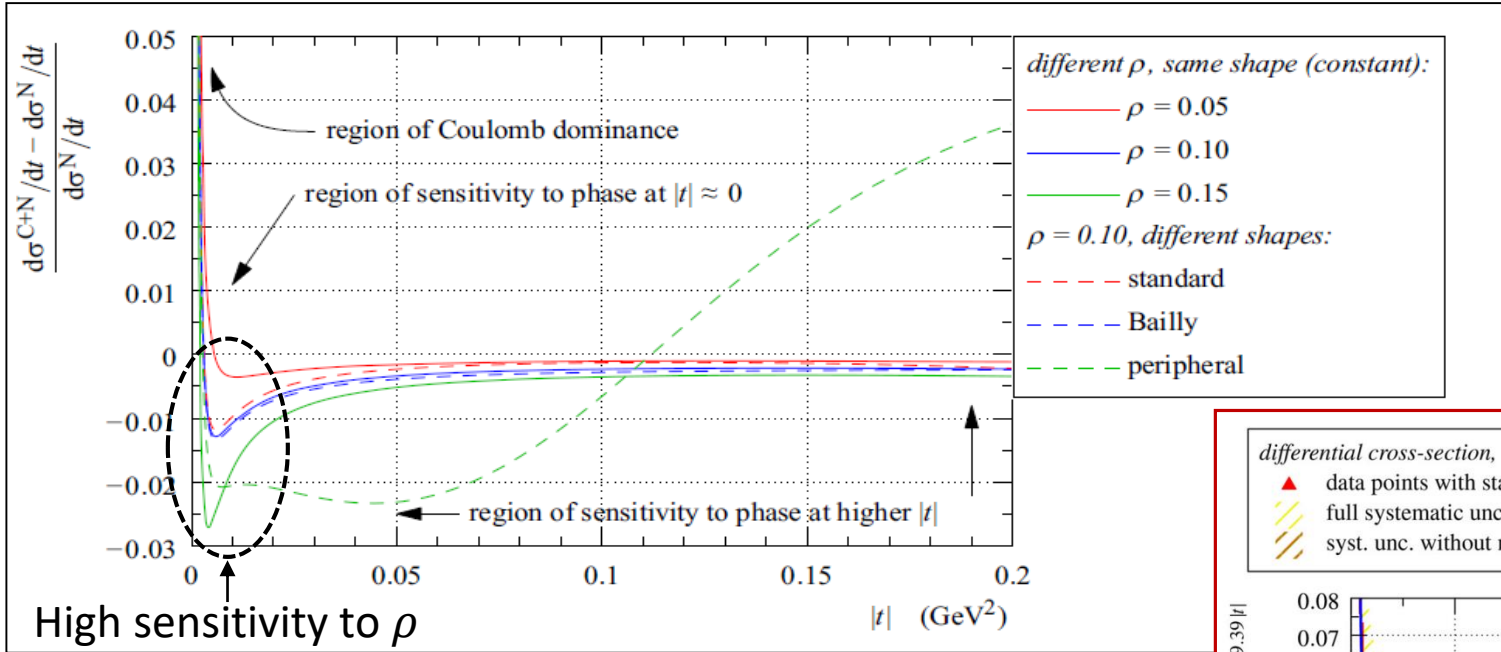

Normalization uncertainty introduces an overall scaling factor. Modification to the distribution shape and to the ρ value negligible.

- Different combinations of phase/ CNI parametrization and N_b tested. Preferred model use $N_b=3$, negligible dependence on phase parametrization.
- Different type of normalizations tested, using data at larger t (collected with $\beta^* = 90m$)

$$\rho = 0.12 \pm 0.3$$

Effects included in systematics.

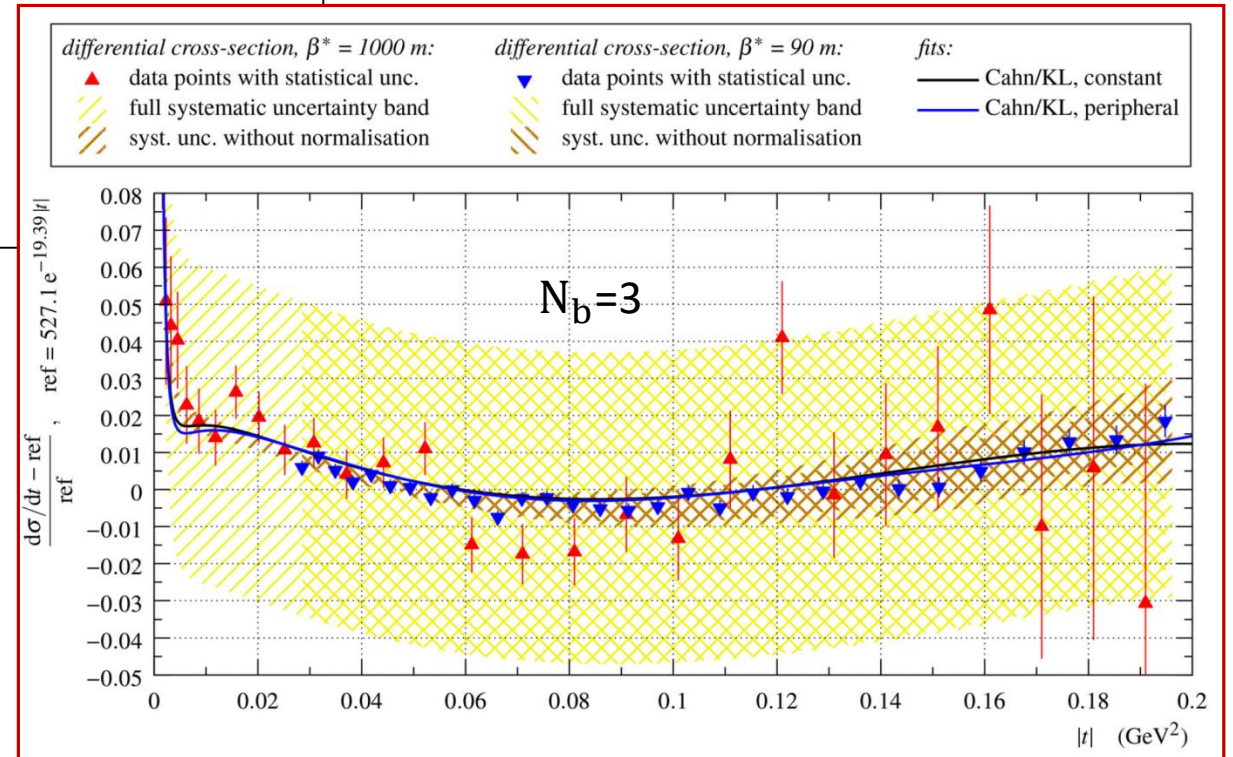

13 TeV and overview at different energies



N_b	$ t _{\max} = 0.07 \text{ GeV}^2$			$ t _{\max} = 0.15 \text{ GeV}^2$		
	χ^2/ndf	ρ	$\sigma_{\text{tot}} \text{ (mb)}$	χ^2/ndf	ρ	$\sigma_{\text{tot}} \text{ (mb)}$
1	0.9	0.09 ± 0.01	111.8 ± 3.1	2.1	–	–
2	0.9	0.10 ± 0.01	111.9 ± 3.1	1.0	0.09 ± 0.01	111.9 ± 3.1
3	0.9	0.09 ± 0.01	111.9 ± 3.0	0.9	0.10 ± 0.01	112.1 ± 3.1

Preferred fit
Large t-range
coverage

Important for fair comparison with previous experiments

$N_b = 3, |t|_{\max} = 0.15 \text{ GeV}^2$

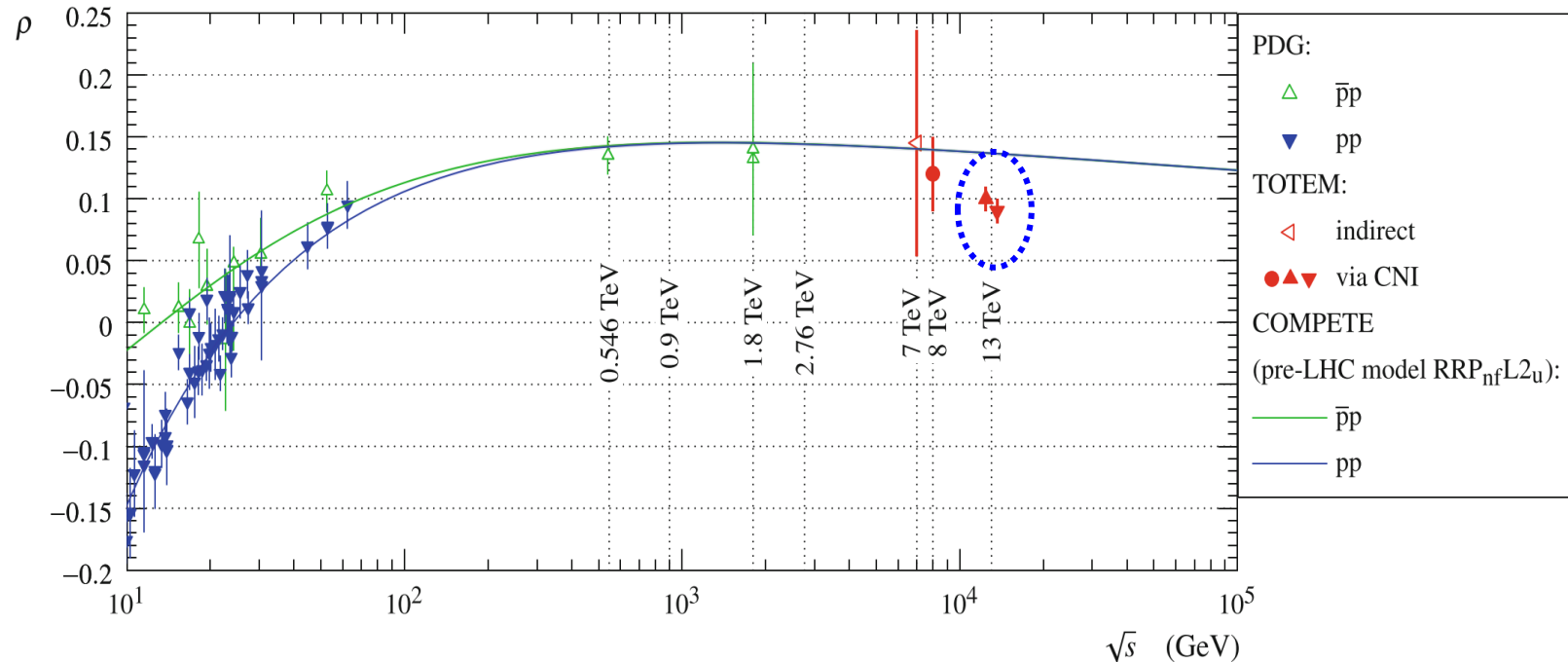
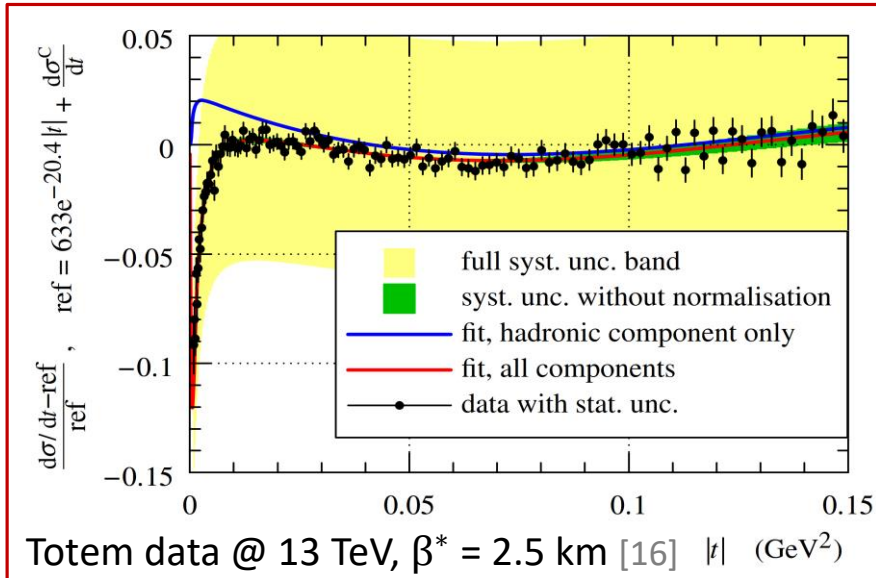

Coulomb region used also as normalization to compute the total cross section. Result in agreement with the one previously discussed

Model comparison – Odderon evidence

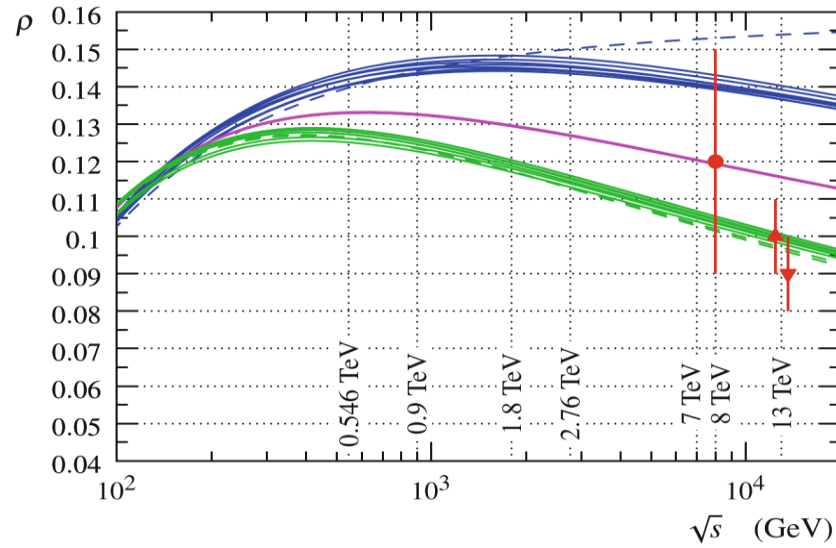
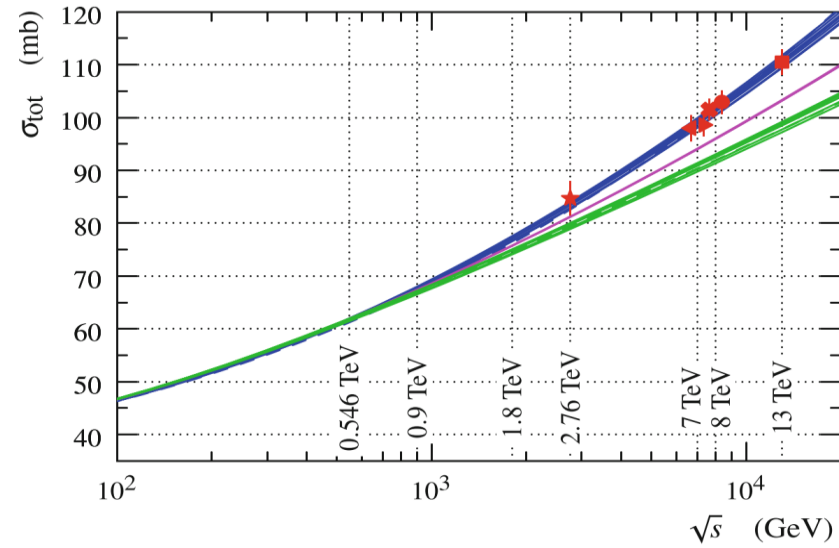

No COMPETE model (where C-odd component not included) able to describe TOTEM σ_{tot} & ρ measurements
 Preferred model incompatibility 4.6σ

↓

Evidence for Odderon existence [15]

Alternative: slowing down of σ_{tot} , not expected from current models and data

Models with C-odd exchange can describe the data[17,18].

Precise ρ measurements at 900 GeV (data available, analysis ongoing) and 14 TeV (scheduled during LHC Run 3) would be valuable for discrimination between Odderon models.

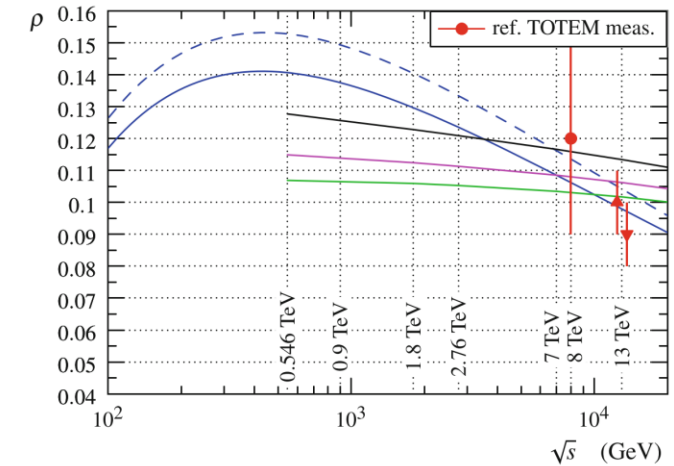
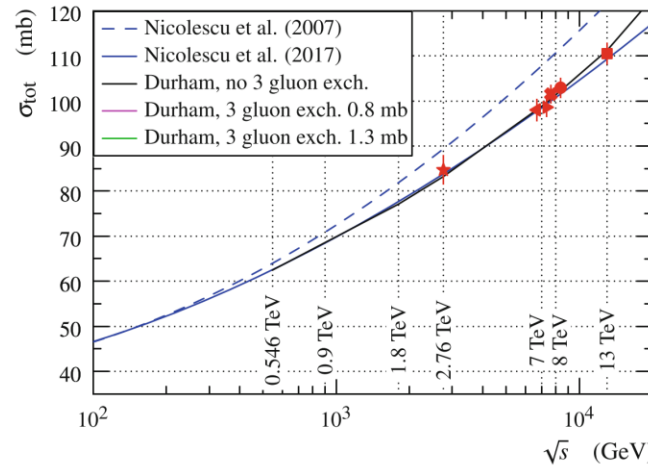

DØ experiment



The DØ experiment at Tevatron has measured the $p\bar{p}$ differential cross section ($\sqrt{s}=1.96$ TeV) in the range $0.26 < |t| < 1.2$ GeV² with the Forward Proton Detector (FPD) spectrometer system[19].

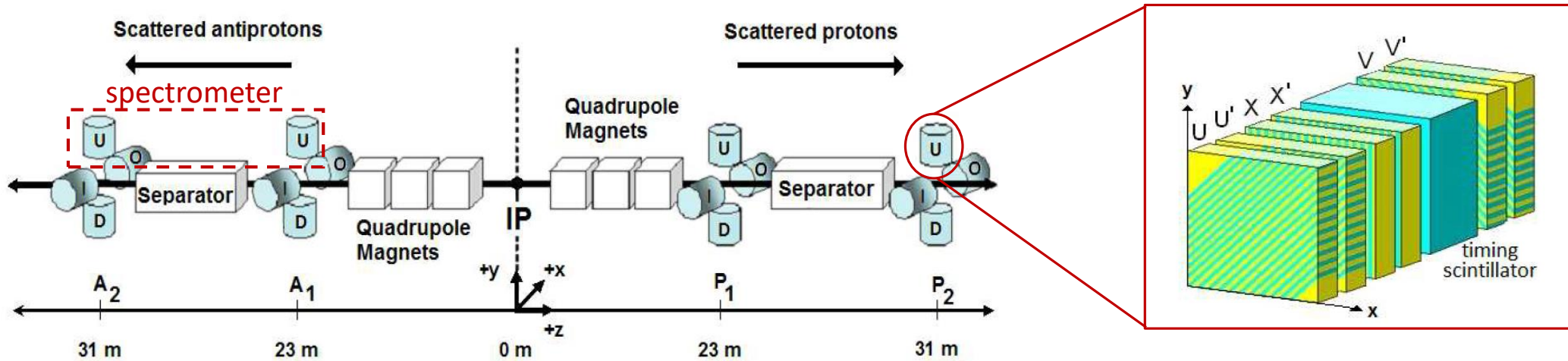

- The FPD detectors used for the analysis consists of four spectrometers on both the scattered proton and scattered antiproton sides, two vertical and two horizontal.
- Each spectrometer is composed of two scintillating fiber detectors, located at about 23 and 31 m from the IP.
- Proton detectors are hosted in Roman Pot like in the TOTEM setup.
- Each position detector consists of six layers of scintillating fibers with different orientations and offset
- Each detector package contains a scintillator timing layer (precision ~ 1 ns), used to suppress beam halo background.

Proton kinematics reconstruction procedure similar to the one already discussed

Probing the dip-bump structure @ 2.76 TeV



Data collected by TOTEM @2.76 TeV ($\beta^* = 11\text{m}$) are close in energy to D0 result of $p\bar{p}$ measured @1.96 TeV. Two dataset with RP at different approaching distance from the beam -> exploration of different t region
Low- $|t|$ region used for normalization and total cross section measurement

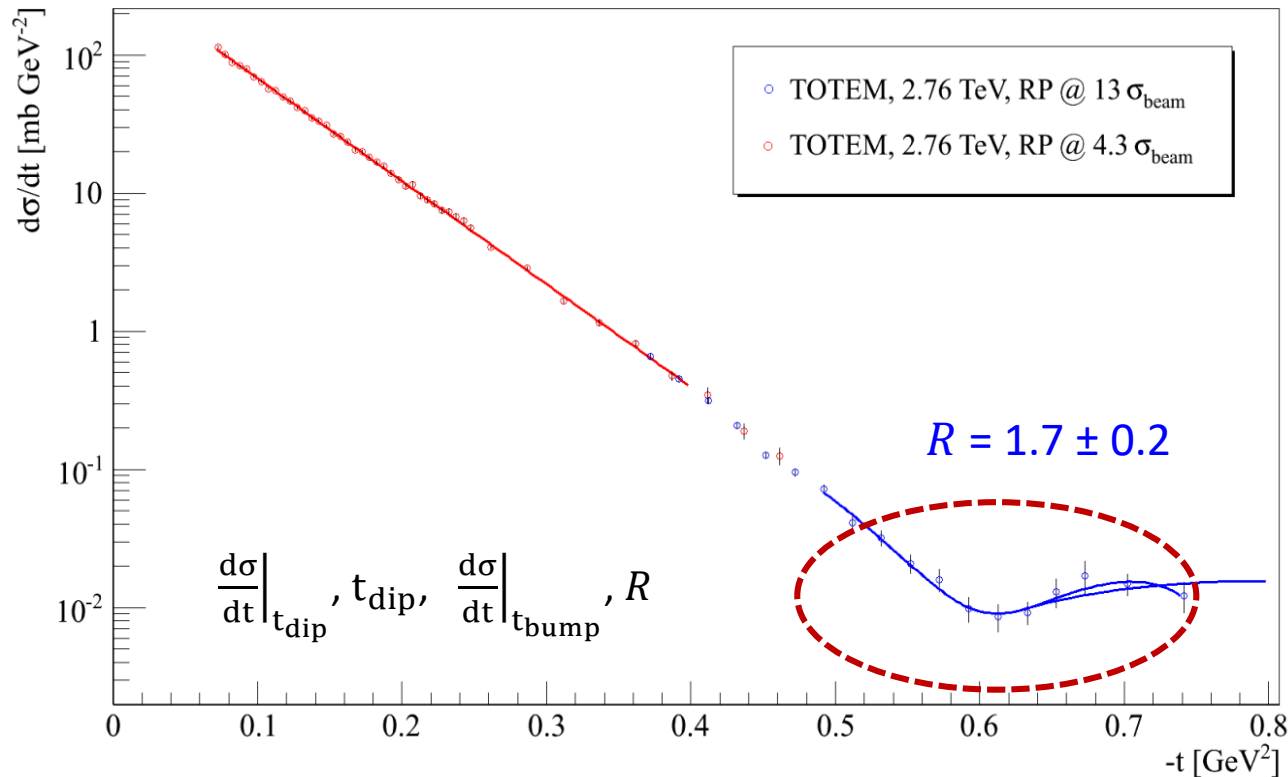

Dip-bump structured compared with the D0 published results[20]. Main parameters:

- $R = \frac{d\sigma}{dt}\Big|_{t_{dip}} / \frac{d\sigma}{dt}\Big|_{t_{bump}}$ (dip-bump ratio)
- B slope in the region close to the dip ($0.36 < |t| < 0.54 \text{ GeV}^2$)

Probing the dip-bump structure @ 2.76 TeV

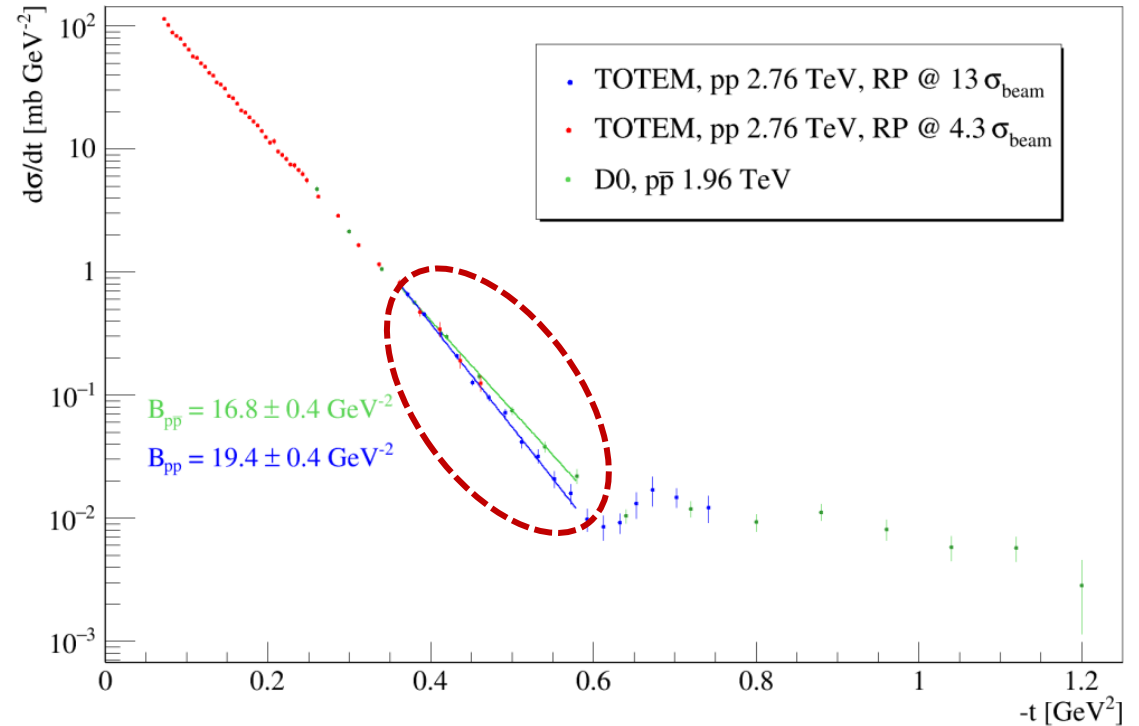
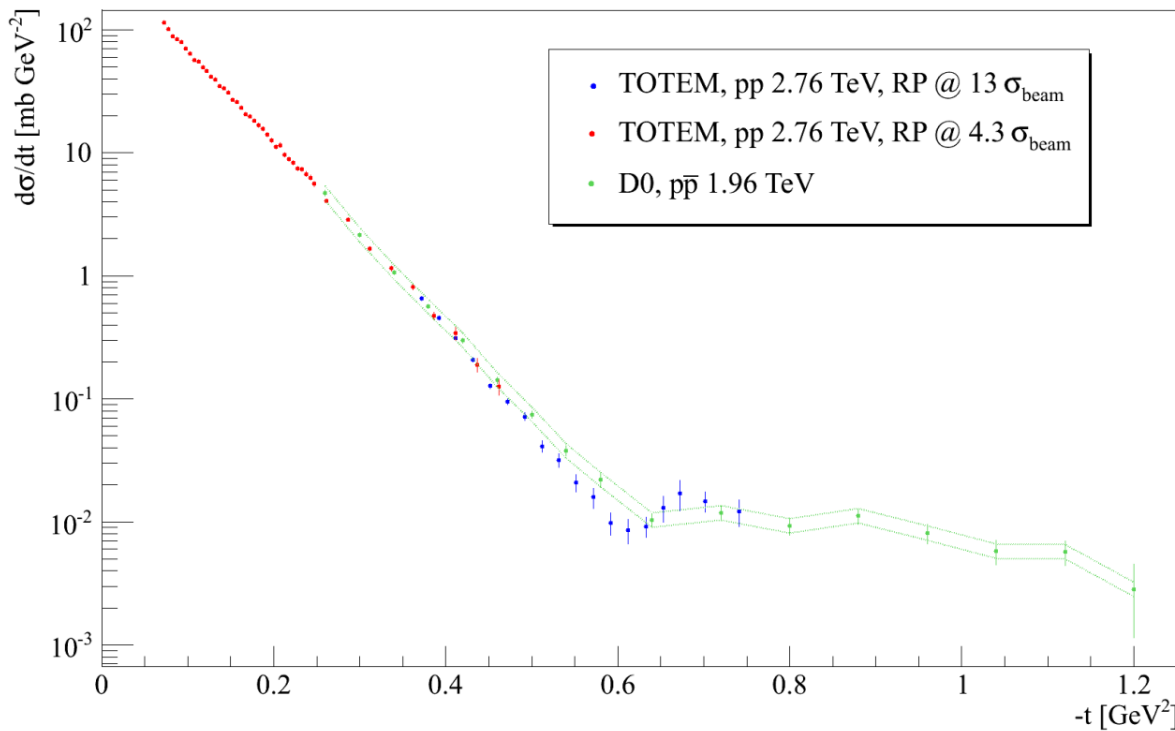

$$R_{pp} = 1.7 \pm 0.2; R_{p\bar{p}} = 1.0 \pm 0.1$$

$$B_{pp} = 19.4 \pm 0.4 \text{ GeV}^{-2}; B_{p\bar{p}} = 16.8 \pm 0.4 \text{ GeV}^{-2}$$

Significant incompatibility $\sim 3\sigma$ for R, $\sim 4\sigma$ for B

But...since the nuclear slope and the R parameter depend on \sqrt{s} , the difference could still be due to the 800 GeV difference in energy.

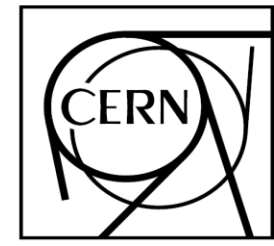

Comparison of pp and $p\bar{p}$ differential elastic cross sections and observation of the exchange of a colorless C -odd gluonic compound

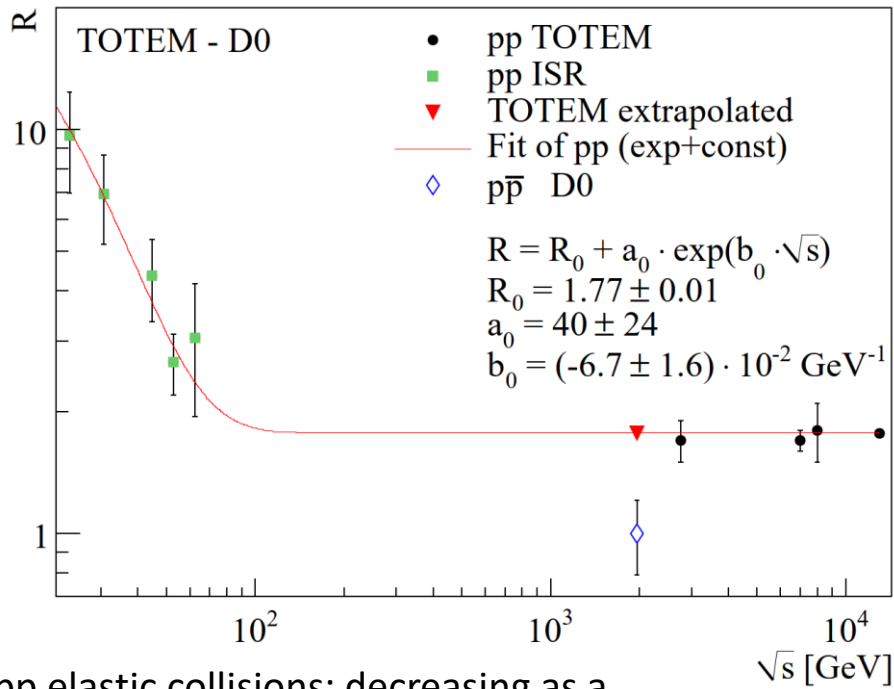

➤ R in pp elastic collisions: decreasing as a function of \sqrt{s} up to 100 GeV and flat above

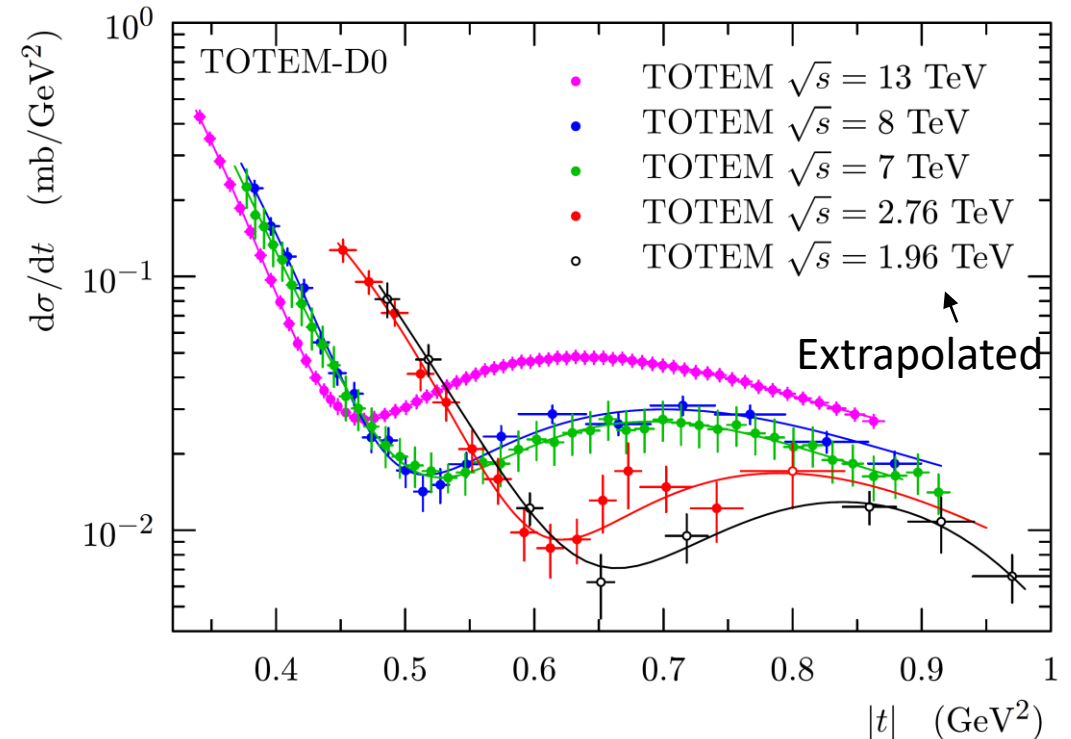

Characteristic point extrapolation

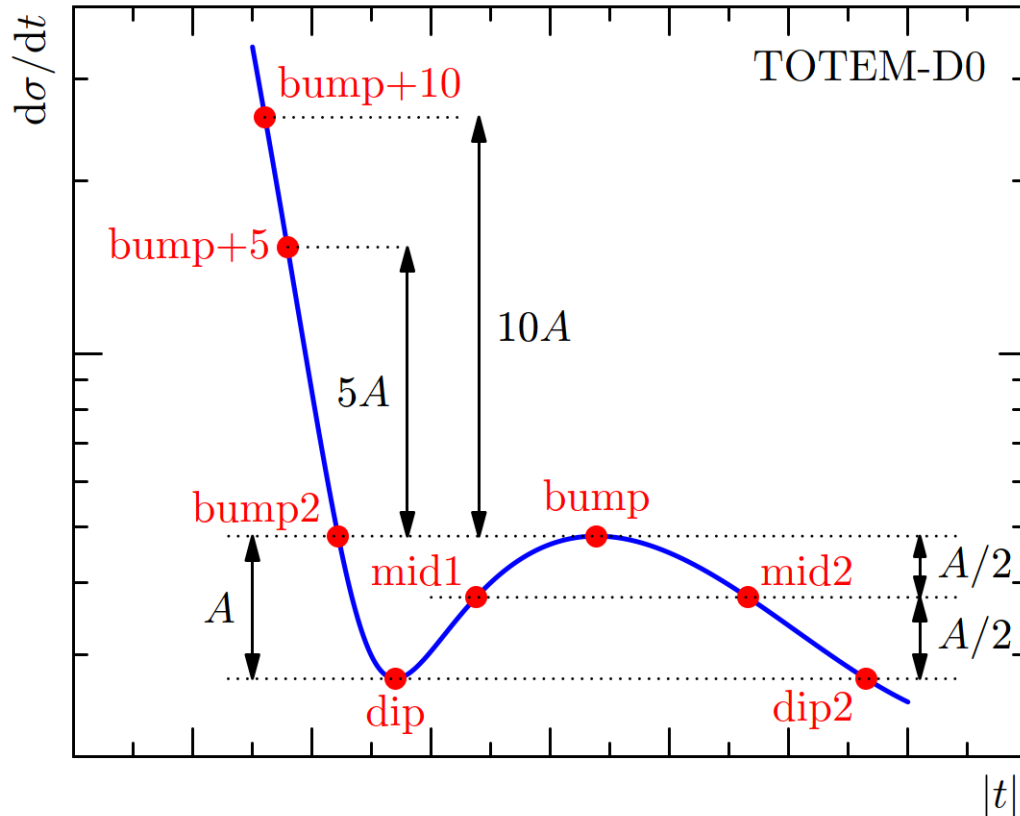

TOTEM-D0 has performed a joint study

- Define 8 characteristic points on the pp elastic $d\sigma/dt$ that fully constraint the shape of the distribution
- Determine the energy dependence of $|t|$ and $d\sigma/dt$ of the characteristic points and extrapolate to 1.96 TeV
- Fit and normalize the extrapolated point
- Compare the data with D0
- Combine with previous TOTEM results

- Values of $|t|$ and $d\sigma/dt$ are taken from the closest measured point (avoiding model-dependent fits). If two adjacent data point are almost equal values, the bin are merged

Characteristic point extrapolation

The evolution of the reference point as a function of \sqrt{s} can be fitted with functional formulae to determine their values @1.96 TeV:

Same fit functions for all characteristic points

$$|t| = a \log(\sqrt{s}[\text{TeV}]) + b$$

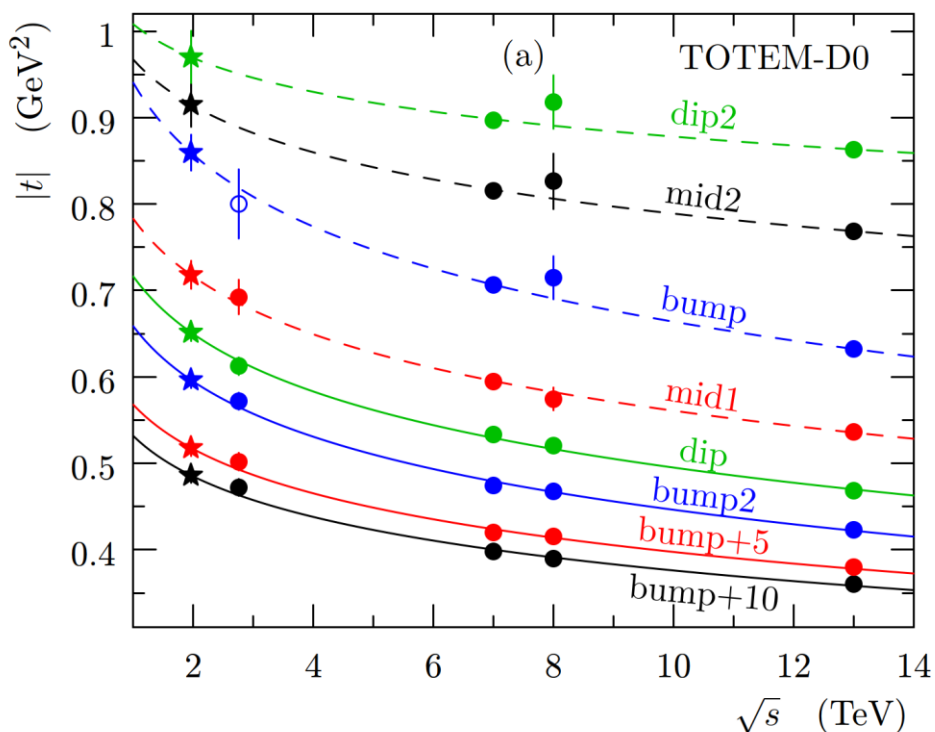

$$d\sigma/dt = c \sqrt{s}[\text{TeV}] + d$$

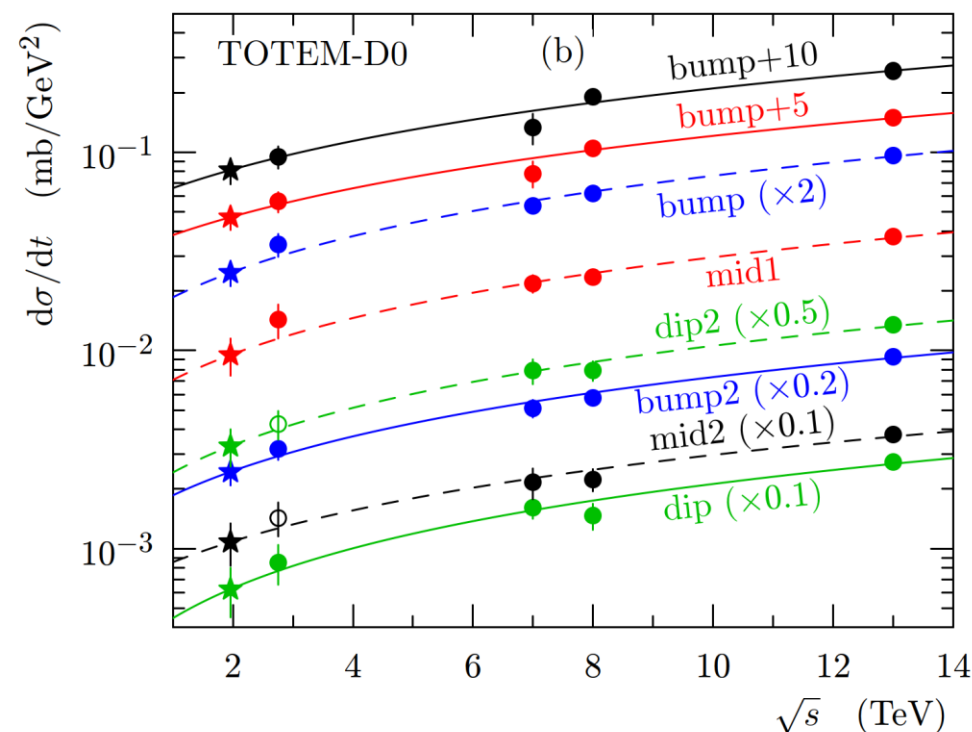

Very good χ^2/dof , lower than 1 for most of the fits

Other function tested, all extrapolation agree within uncertainties. Effect included in the systematics

Fits of TOTEM extrapolated characteristic point

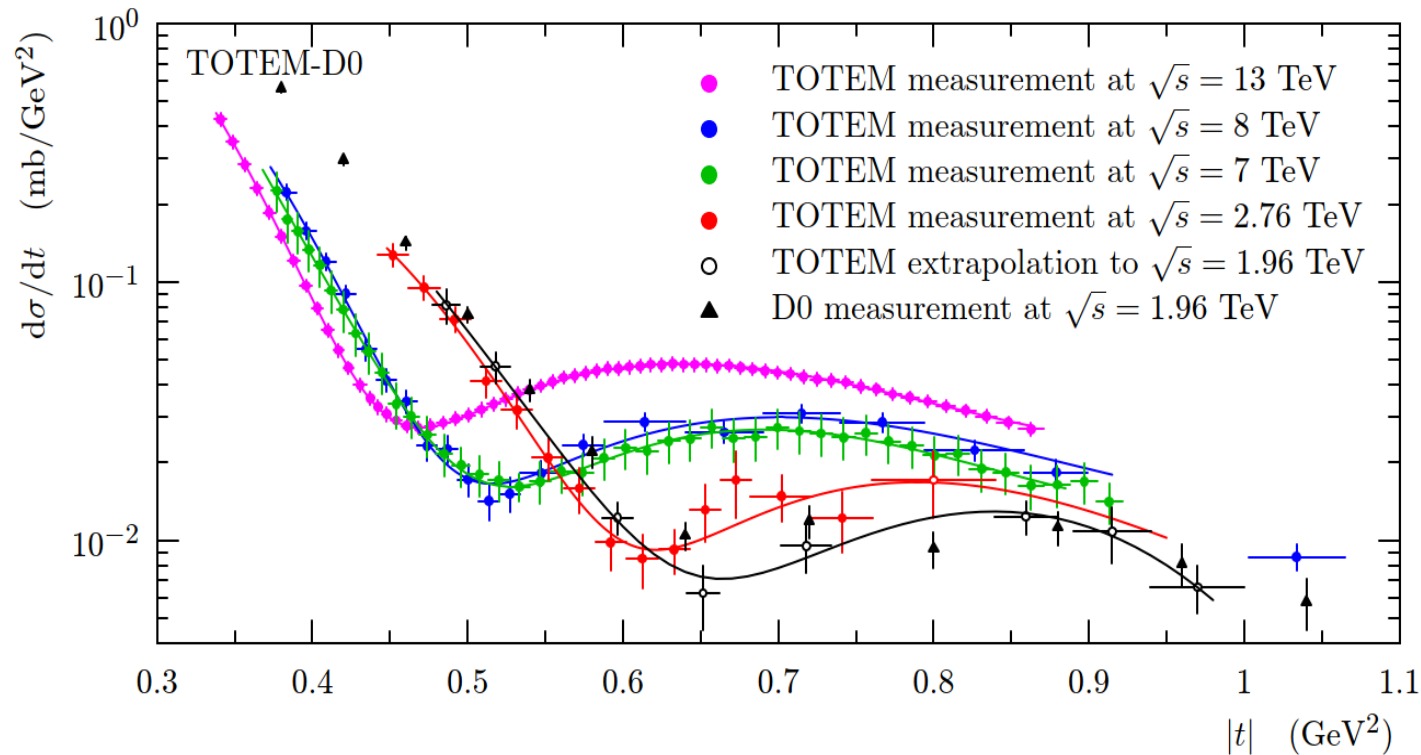

TOTEM data collected 2.76, 7, 8 and 13 TeV can be well described by a double exponential in the dip/bump region:

$$h(t) = a_1 e^{-a_2|t|^2 - a_3|t|} + a_4 e^{-a_5|t|^3 - a_6|t|^2 - a_7|t|}$$

Can be used to fit the extrapolated characteristic points ($\chi^2/\text{dof} = 0.63$)

Systematic uncertainties evaluated from an ensemble of MC experiments in which the cross section values of the eight characteristic points are varied within their Gaussian uncertainties.



The MC simulation ensemble provides a Gaussian-distributed pp cross section at each t-value, allowing a 1σ uncertainty band to be defined. The band can be used to perform a direct comparison with D0, after normalization.

OP normalization



Differences in normalization taken into account by adjusting TOTEM extrapolated points and D0 data sets to have the same cross sections at the optical point ($t=0$):

- pp and $p\bar{p}$ cross section are the same if no C-odd exchange are present
- Effect of possible Odderon included in systematics
- Constraining the OP implies a constraint on slope parameter B

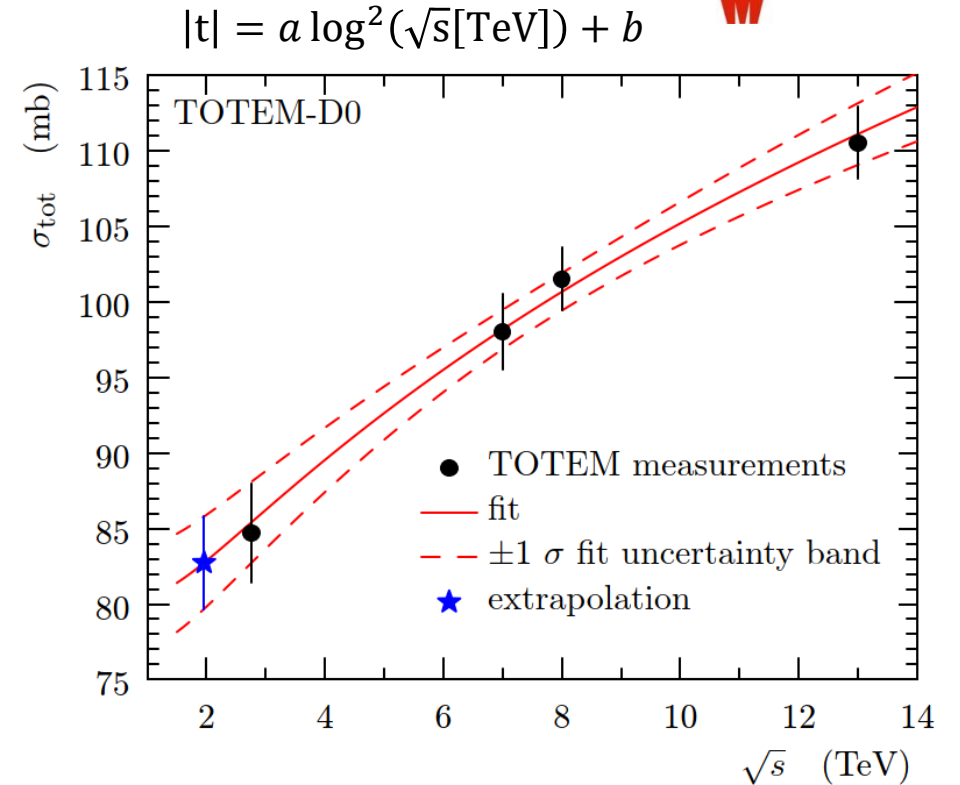

Extrapolate total cross section from TOTEM measurements to 1.96 TeV

$$(\sigma_{tot} = b_1 \log^2(\sqrt{s}/1\text{TeV}) + b_2)$$

$$\sigma_{tot} = 82.7 \pm 3.1 \text{ mb}$$

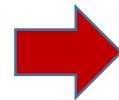

Compute optical point inverting optical theorem ($\rho = 0.145$ from COMPETE)

$$\left. \frac{d\sigma}{dt} \right|_{t=0} = 357 \pm 26 \text{ mb/GeV}^2$$

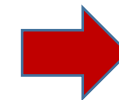

Calculate OP normalization factor as the ratio of TOTEM and D0 ($341 \pm 48 \text{ mb/GeV}^2$)

$$\text{Scale factor} = 0.954 \pm 0.071$$

D0 – TOTEM comparison

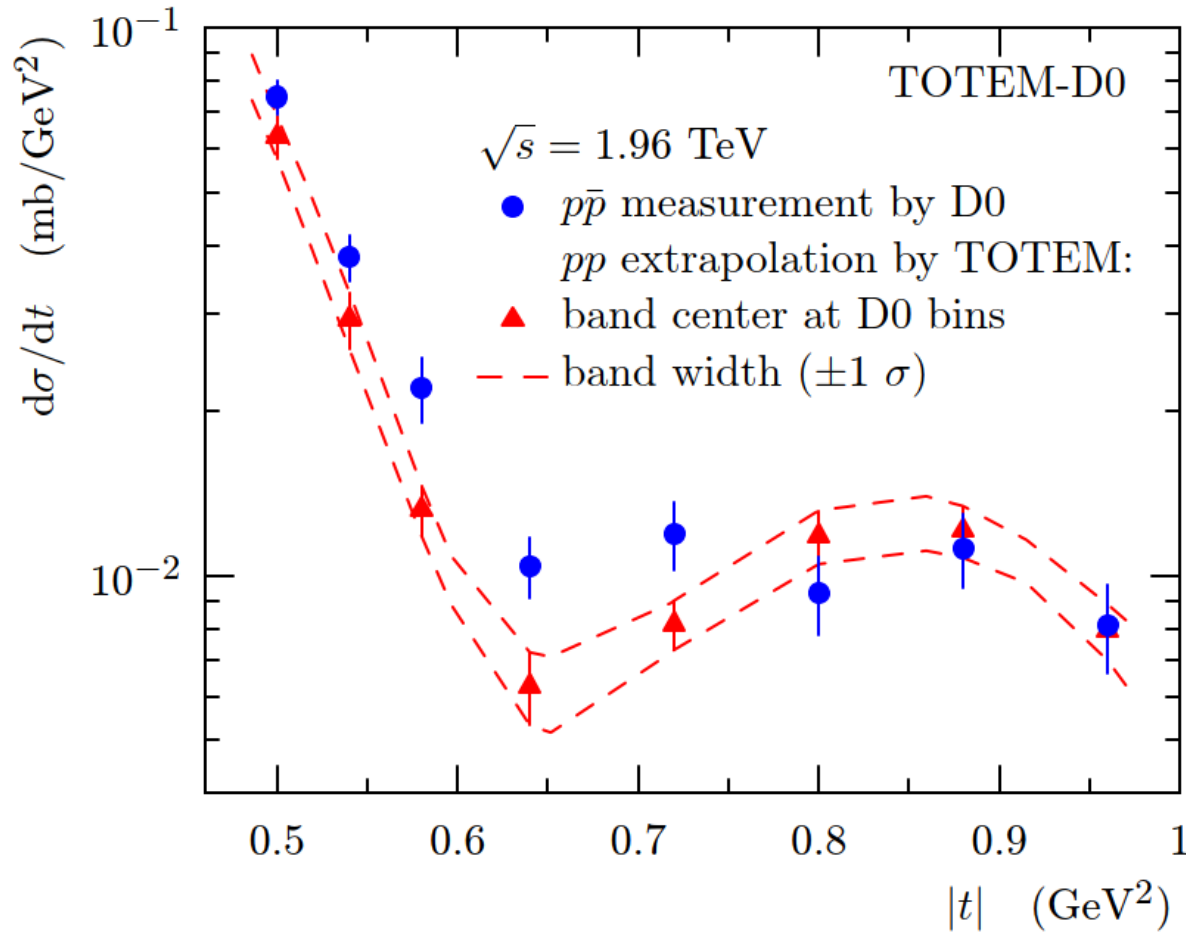

χ^2 test to examine the probability for the D0 and TOTEM differential elastic cross sections to agree.

The test use the difference of the integrated cross section in the examined $|t|$ -range with its fully correlated uncertainty, and the experimental and extrapolated points with their covariance matrices

Given the constraints on the OP normalization of the elastic cross sections, the χ^2 test with six degrees of freedom yields the p-value of 0.00061, corresponding to a significance of 3.4σ

Combined significance

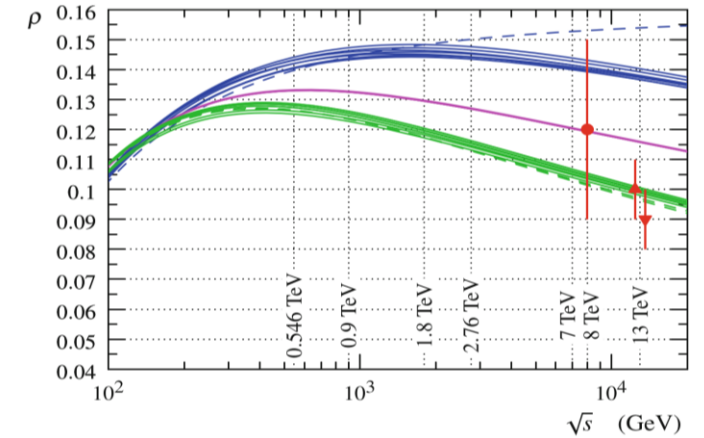
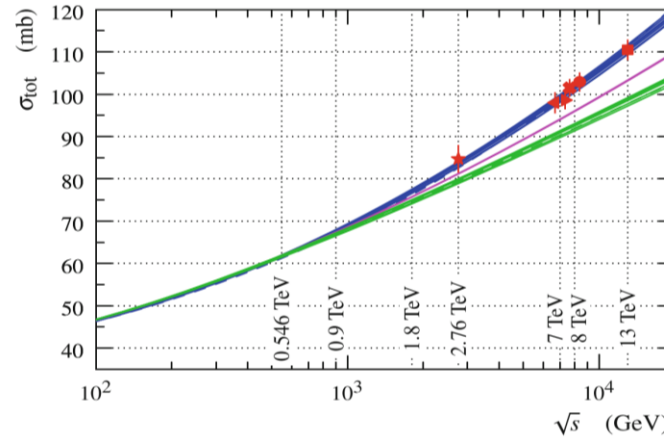
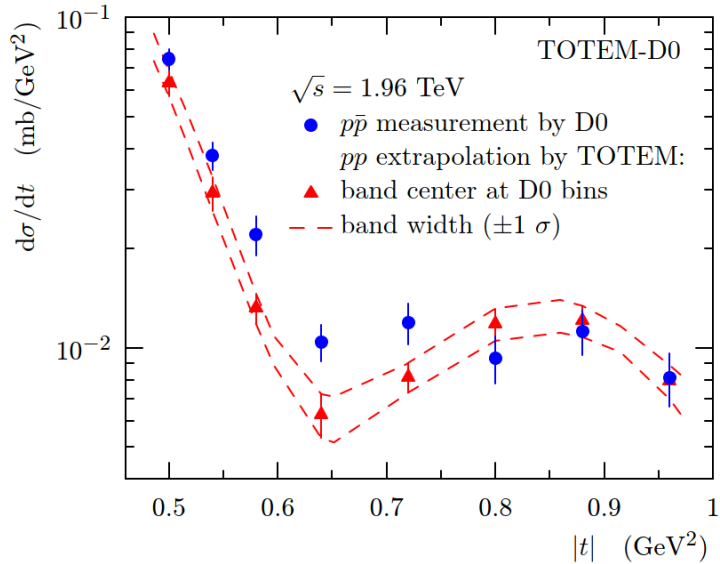

Cross section and ρ measurements in completely different t-range w.r.t the pp/ $p\bar{p}$ comparison.

Combined significance (Stouffer method) for t-channel exchange of a colorless C-odd gluonic compound :

- 5.7 σ if preferred COMPETE model is used
- 5.2 to 5.7 σ depending on the model, including model uncertainties

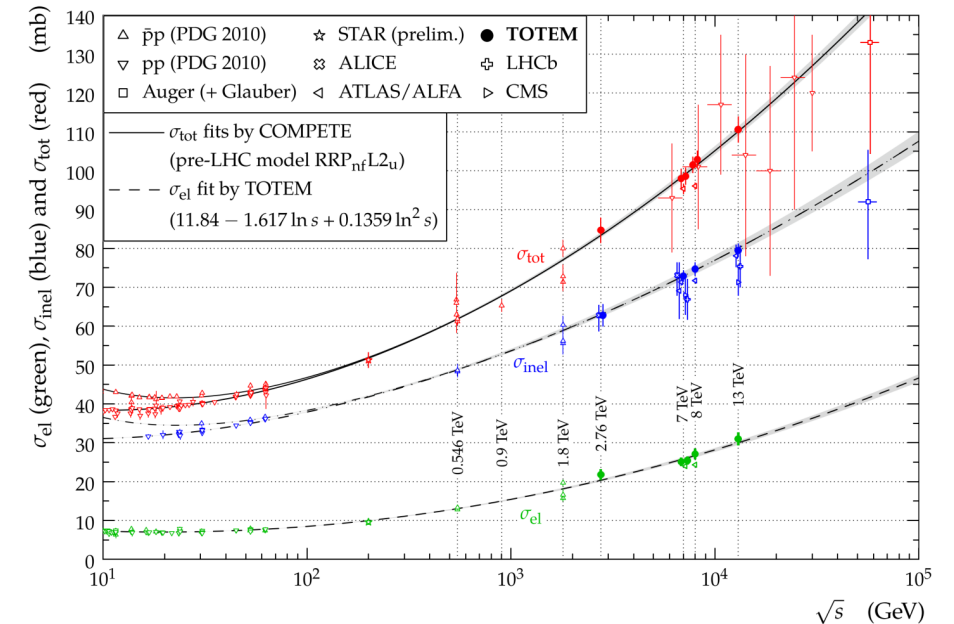

pp cross-section @14 TeV



Totem will perform a new set of measurements @ 14 TeV to confirm and extend the cross section and ρ measurements

T1 and T2, after having successfully sustained a radiation damage 10 times above the design requirements, have been dismantled.

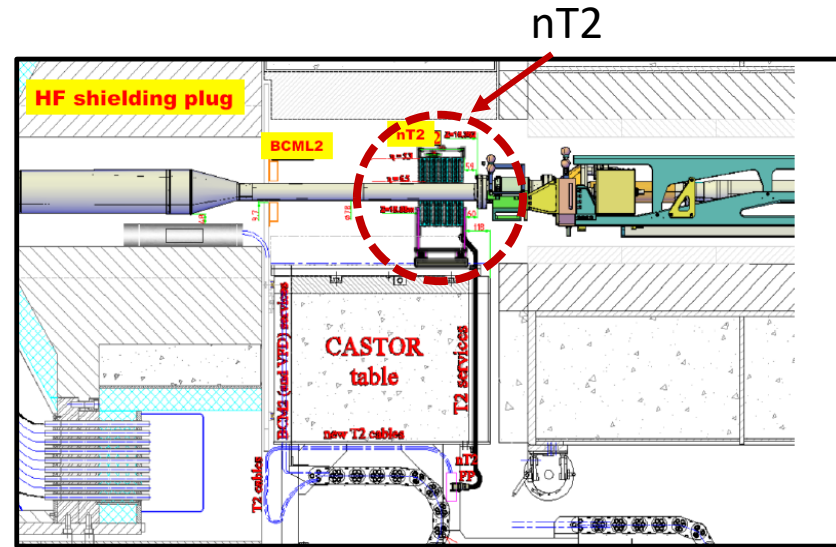

Previous inelastic detectors T2 will be replaced by a new inelastic telescope (nT2) based on scintillators readout by SiPMs.

Not in scale

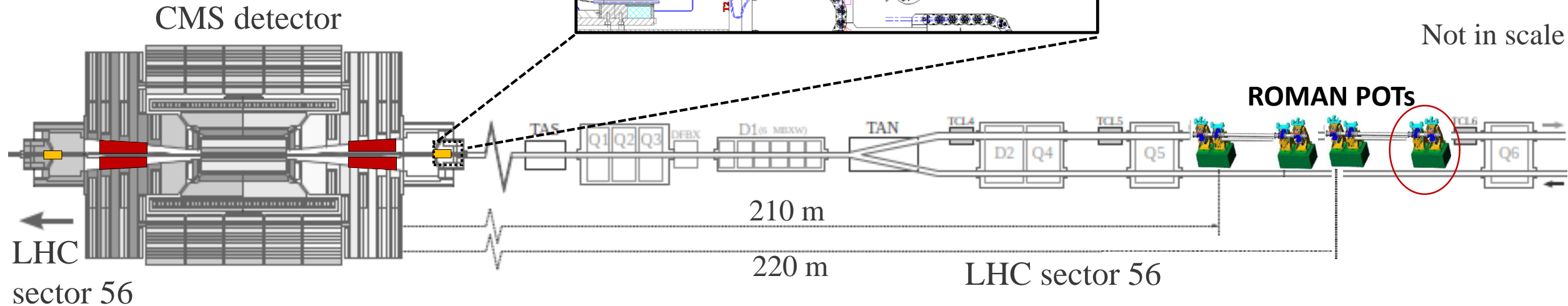

Conclusions



- The Odderon, gluonic compound first theorized in the '70, represents a major prediction of QCD
- The experimental setup of TOTEM allows the measurements of the total, elastic and inelastic cross section with different approaches. All methodologies agree within errors.
- TOTEM has reached the CNI region and made a direct measurement of ρ at different LHC energies: no COMPETE model (where C-odd component is not included) able to describe simultaneously TOTEM σ_{tot} & ρ measurements
- Detailed comparison between pp (1.96 TeV from D0) and $p\bar{p}$ (2.76, 7, 8, 13 TeV from TOTEM) elastic $d\sigma/dt$ data (FERMILAB-PUB-20-568-E; CERN-EP-2020-236)
 - pp and $p\bar{p}$ cross sections differ with a significance of 3.4 in a model-independent way and thus provides evidence that the Colorless C-odd gluonic compound, the Odderon, is needed to explain elastic scattering at high energies.
 - When combined with the ρ and total cross section result at 13 TeV, the significance is in the range 5.2 to 5.7 and thus constitutes the first experimental observation of the Odderon: major discovery at CERN/Tevatron
- Future data collected at 14 TeV and ongoing analysis at 900 GeV will add further information and constraints on models

Bibliography



- [1] V.Barone and E.Pedrazzi, “High energy particle diffraction”, Springer, 2002
- [2] A.Donnachie and P.V.Landshoff , *Phys.Lett. B*, **296** (1992) 227-232
- [3] L. Lukaszuk and B. Nicolescu, *Lett. Nuovo Cim.* **8** (1973) 405.
- [4] C.J Morningstar and M.Peardon, *Phys. Rev. D*, **60** (1999)034509
- [5] C.Ewertz, arXiv:hep-ph/0306137 (2003)
- [6] J. Bartels, *Nucl. Phys. B*, **175** (1980) 365
- [7] J. Kwiecinski and M. Praszalowicz, *Phys. Lett. B*, **94** (1980) 413
- [8] R.A.Janik and J.Wosiek, *Phys.Rev.Lett.*, **82** (1999) 1092
- [9] J. Bartels, L. N. Lipatov and G. P. Vacca, *Phys. Lett. B*, **477** (2000) 178
- [10] J.B. Bronzan, G.L. Kane, U.P. Sukhatme, *Phys. Lett. B*, **49** (1974) 3, pp.272-276
- [11] The TOTEM Collaboration, *EPL*, **98** 31002 (2012)
- [12] The CMS and TOTEM collaborations, *Eur. Phys. J. C* **74**, 3053 (2014).
- [13] The TOTEM collaboration, *EPL* **101** 21004 (2013)
- [14] The TOTEM collaboration, *Eur. Phys. J. C* **79**, 103 (2019).
- [15] The TOTEM collaboration, *Eur. Phys. J. C* **76** (2016) 661
- [16] The TOTEM collaboration, *Eur.Phys.J.C* **79** (2019) 9, 785
- [17] V.A. Khoze, A.D. Martin and M.G. Ryskin, *Phys. Rev. D*, **97** (2018) 034019
- [18] E. Martynov and B. Nicolescu, *Phys.Lett. B*, **778** (2018) 414
- [19] The D0 collaboration, *Phys. Rev. D*, **86** (2012) 012009
- [20] The TOTEM collaboration, *Eur.Phys.J.C*, **80** (2020) 2, 91