

# *IFR Geometry Optimization*

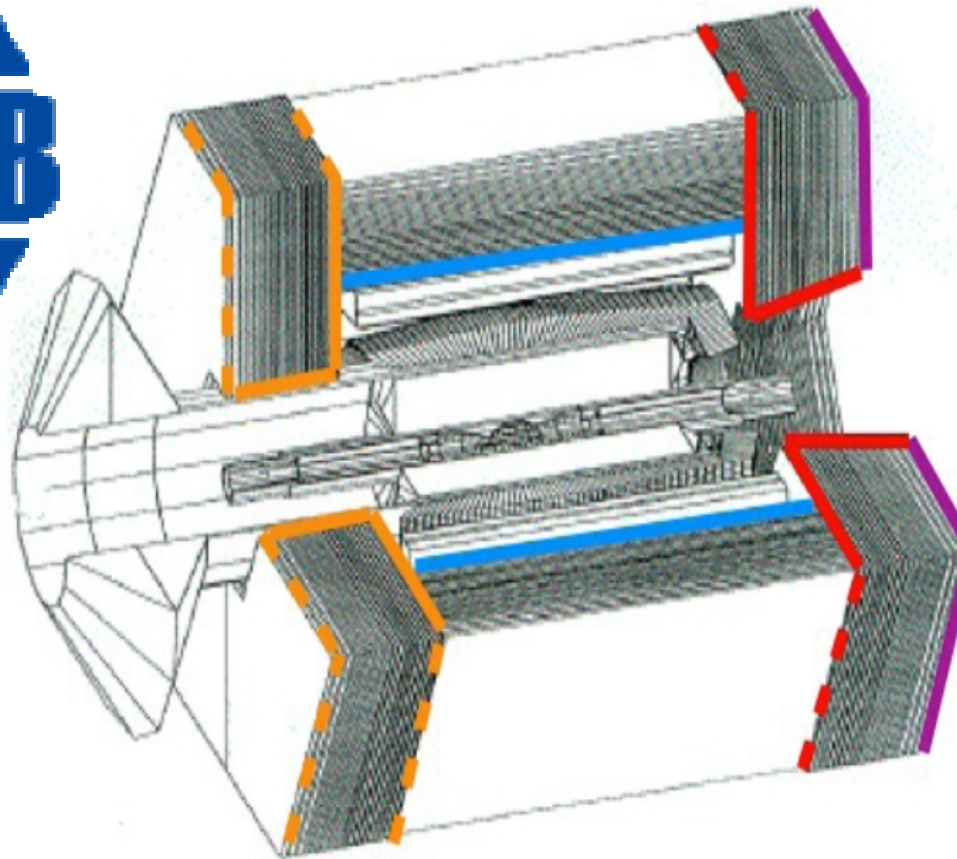

# Outline

- *IFR configurations: progresses since Annecy*
  - ✓ *Do we need an extra layer?*
  - ✓ *Preliminary results using a configuration with 8 and 9 layers*
- *$K_L$  first studies*
  - ✓ *Analysis strategy*
  - ✓  *$K_L$  Cluster size*
    - *Very loose  $K_L$  selector to compare  $8_L$  and  $9_L$  active layers*
- *To Do List*

# Results presented at Annecy

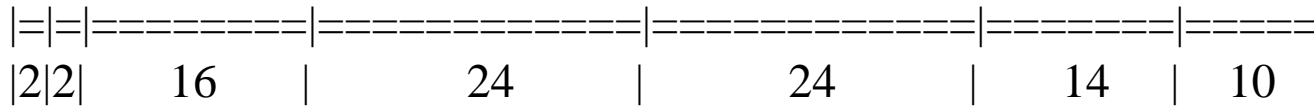

$C_{2'} \sim 920\text{mm}$  ★

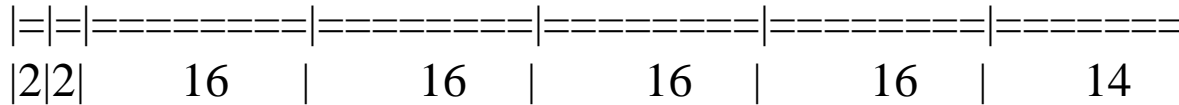

$C_{13} \sim 820\text{mm}$

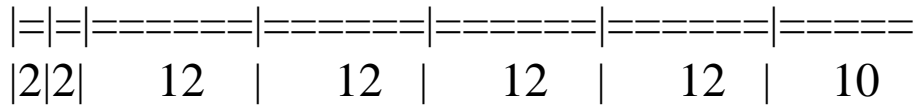

$C_{14} \sim 620\text{mm}$

-  $\mu$  efficiency

$C_{2'}$  ↗

$C_{14}$  ↘  $C_{13}$  ↗

$52.9 \pm 0.3$	$93.1 \pm 0.1$	$80.7 \pm 0.2$	$87.3 \pm 0.2$
$57.0 \pm 0.2$	$75.9 \pm 0.1$	$61.5 \pm 0.2$	$56.0 \pm 0.2$
$51.0 \pm 0.3$	$95.9 \pm 0.1$	$92.1 \pm 0.1$	$92.1 \pm 0.1$

InteractionLength

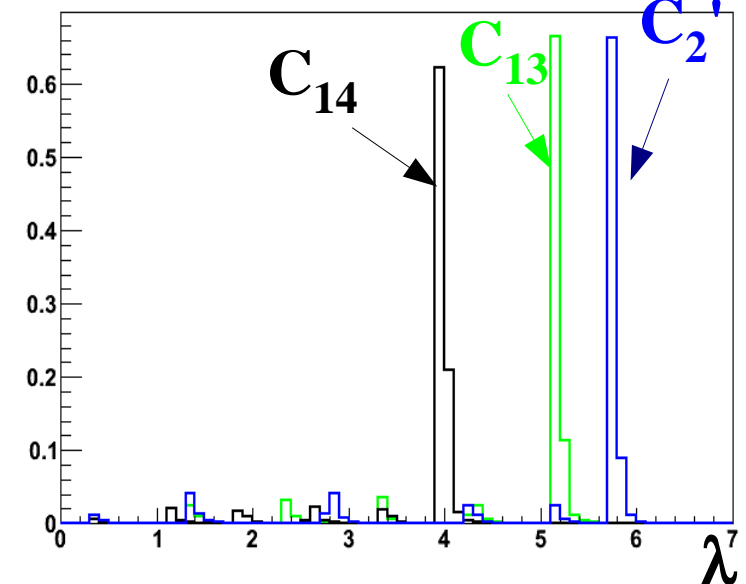

# Compare $8_L$ with $9_L$ configurations

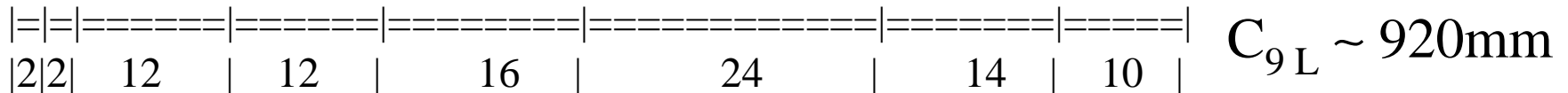
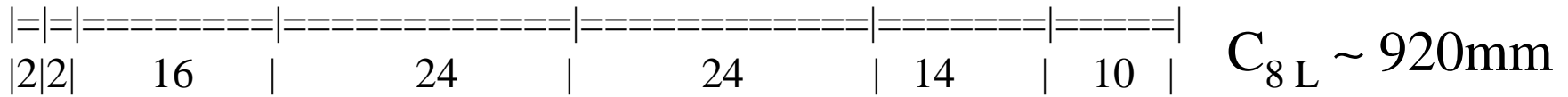

- *Extra layer to check if it is possible to increase the  $\mu$ -efficiency*
- *Simulated 5M of single muons and pions for both the configurations*
- *Momentum range from 0 to 5 GeV/c with flat distribution fired in all the sextants of the barrel*
- *Configurations compared using a BDT as multivariate classification algorithm*
  - *same 9 variables used for the previews comparison ( $C_{13}, C_{14}, C_2'$ )*
- *BDT analysis performed in 4 momentum bins*
  - *check how the result changes adding 1.5% of noise*

# BDT Optimization (noise=0)

0.0 < p < 1.5

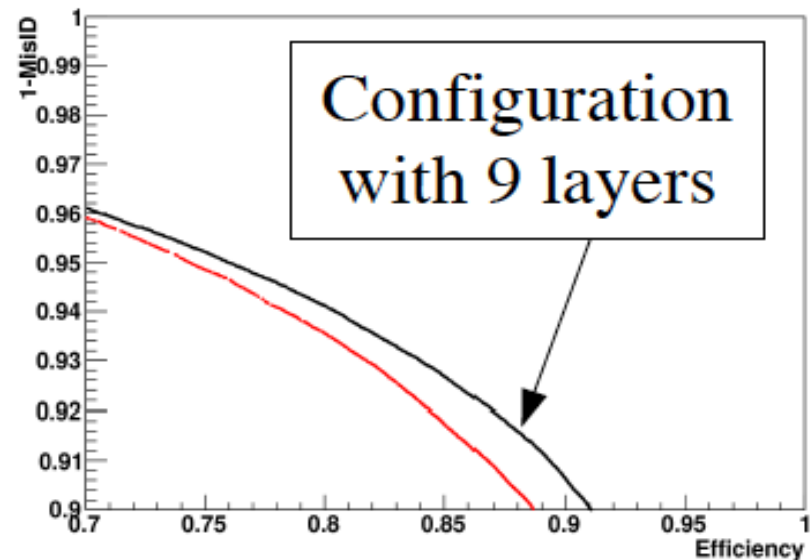

1.5 < p < 2.5

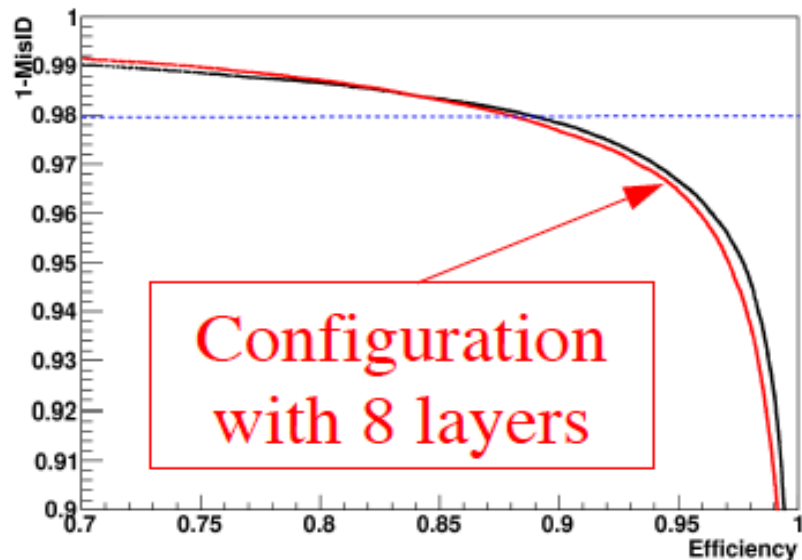

2.5 < p < 3.5

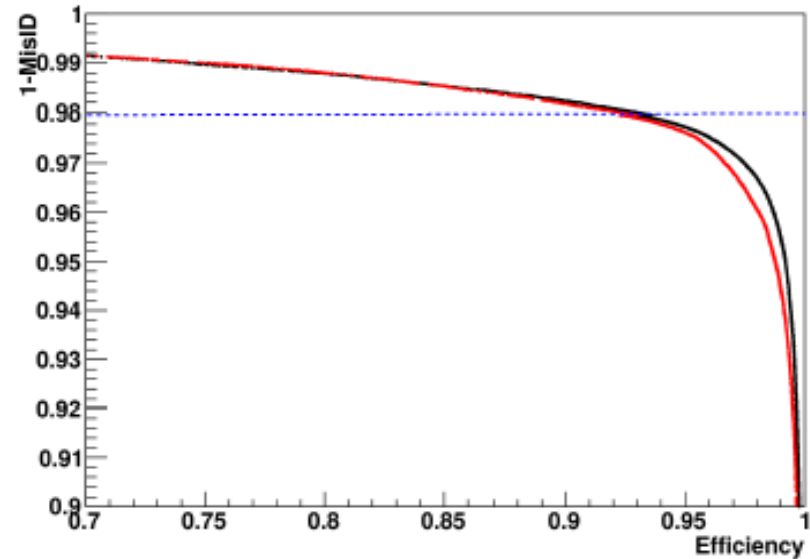

3.5 < p < 5.0

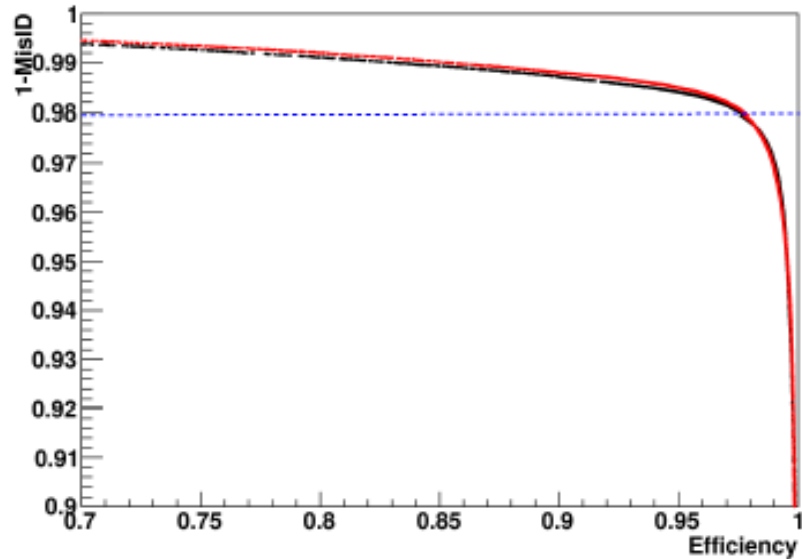

# BDT Optimization (noise = 0)

- Muon efficiency requiring pion mis-ID = 2%

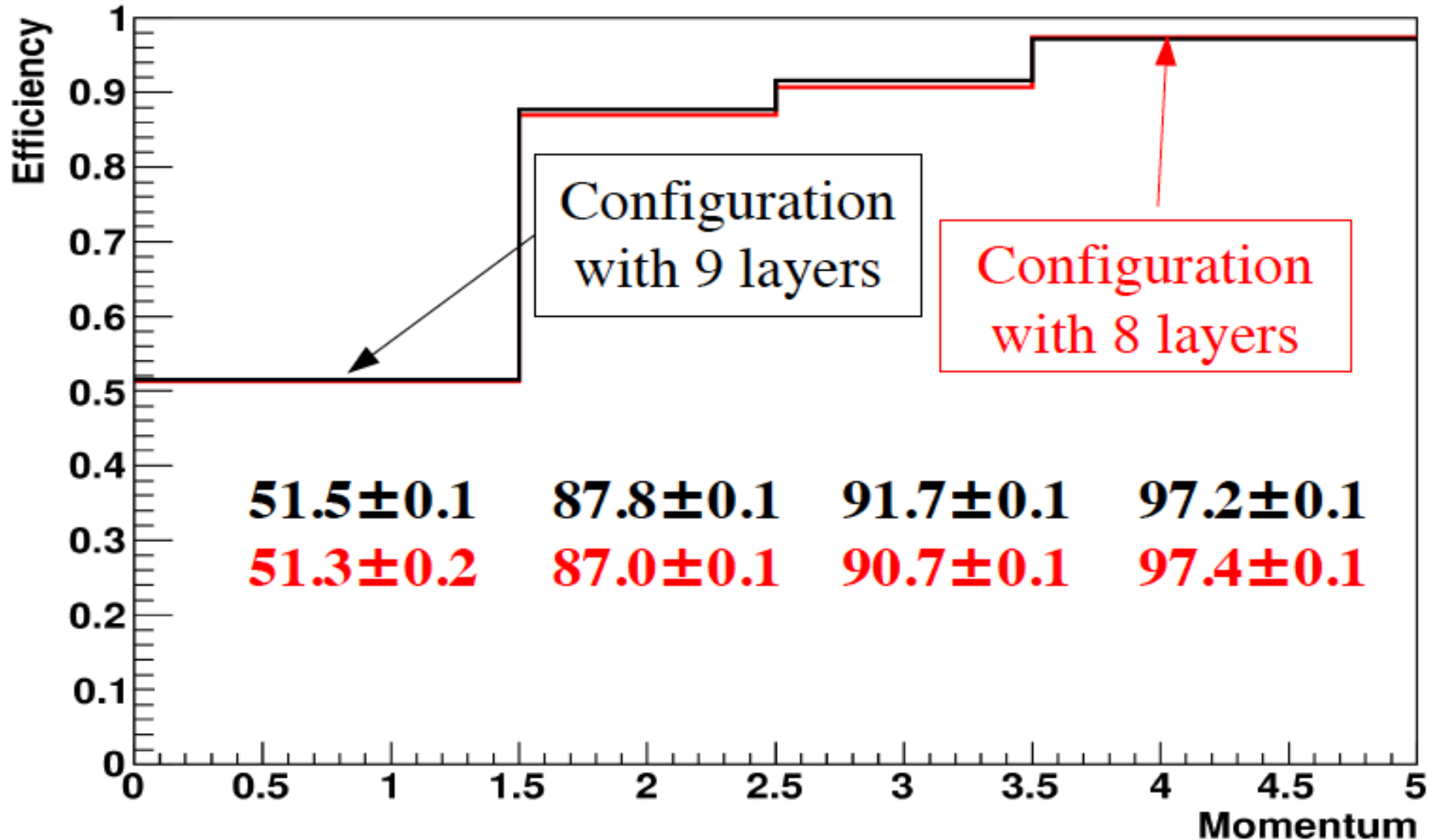

# BDT Optimization (noise = 1.5%)

- Muon efficiency requiring pion mis-ID = 2%

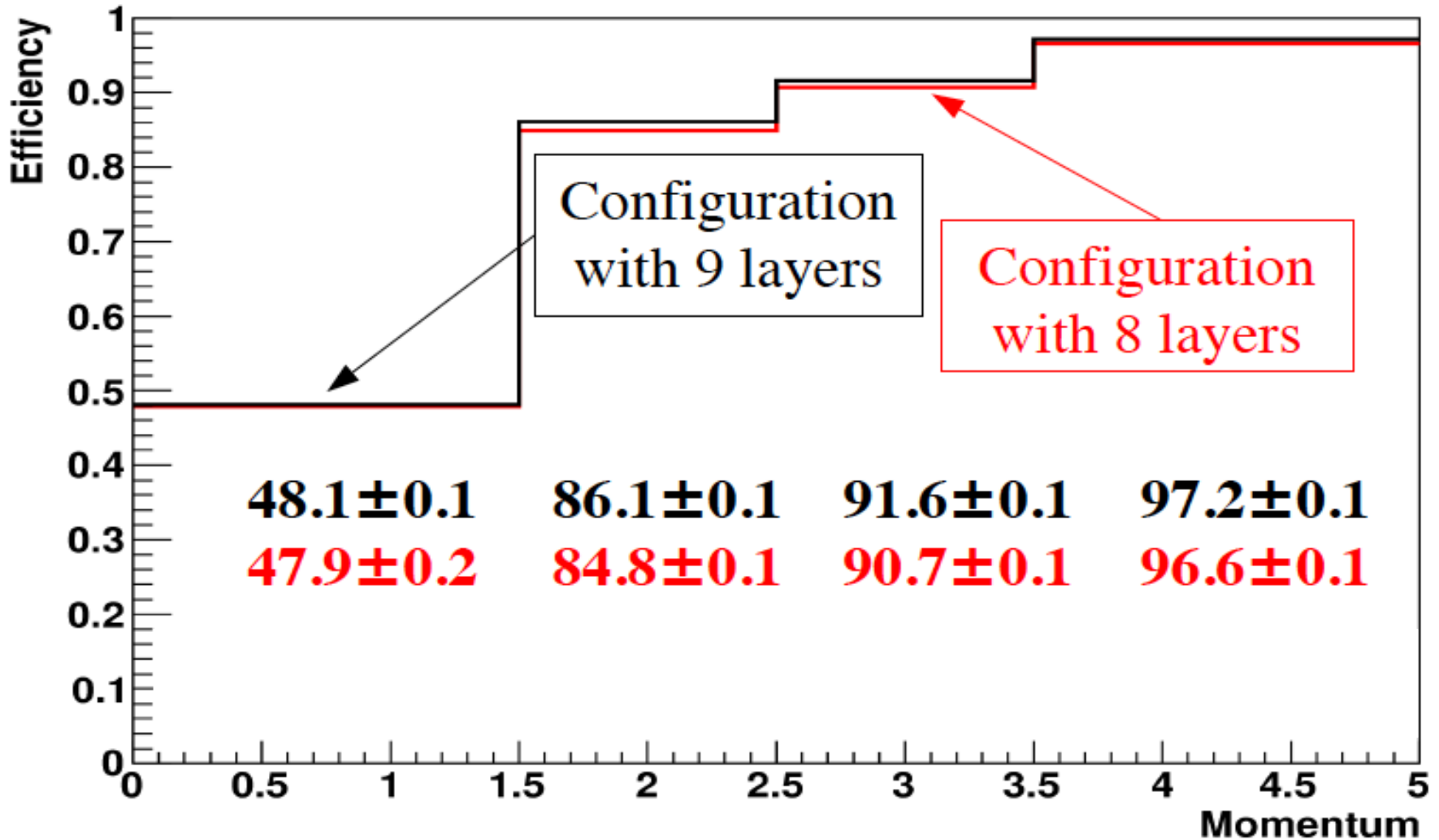

# Test IFR geometry using FastSim

- Produce PID Tables, one for each configuration
- Make available these tables in FastSim before the start of the next production (July)
  - Study the impact of different configuration on specific signal channel
    - $B \rightarrow K^* \mu \mu, B \rightarrow \mu \mu$ , ?
    - and on analysis that use SL  $B \rightarrow D(^*) \mu \nu$  tag

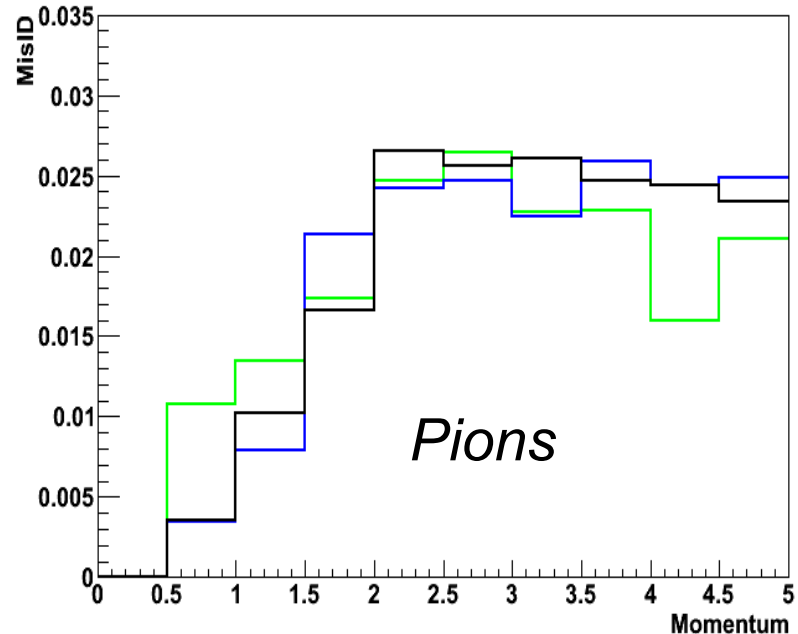
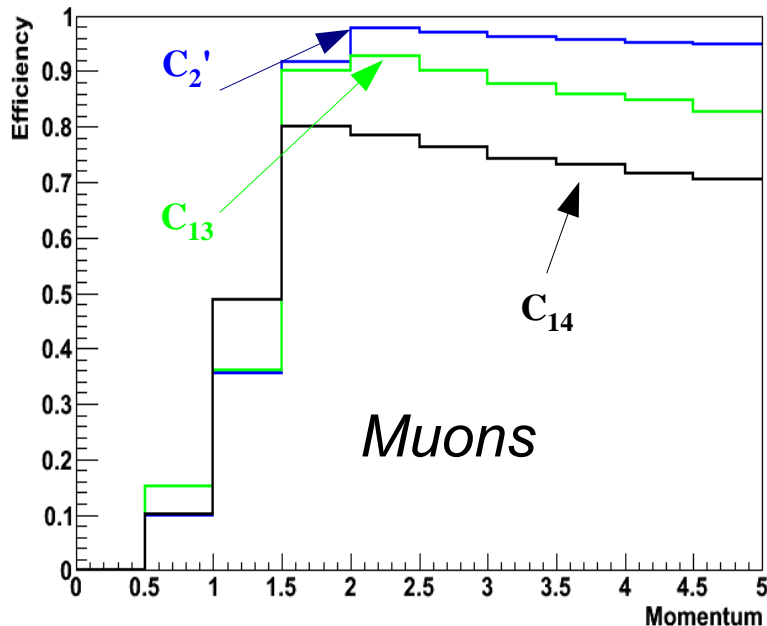



# *First look at $K_L$*

# $K_L$ : analysis strategy

- Simulated 110K single  $K_L$  using  $C_2'$  configuration and 10K using  $C_2'$  with 9 active layers;
  - Momentum range from 0.6 MeV to 4.5 GeV/c with flat distribution, fired orthogonally to the top-sextant of the barrel
- Distinguish  $K_L$  interacting in the EMC from  $K_L$  interacting in the IFR volume
  - Use total energy released in the EMC to distinguish these  $K_L$  categories

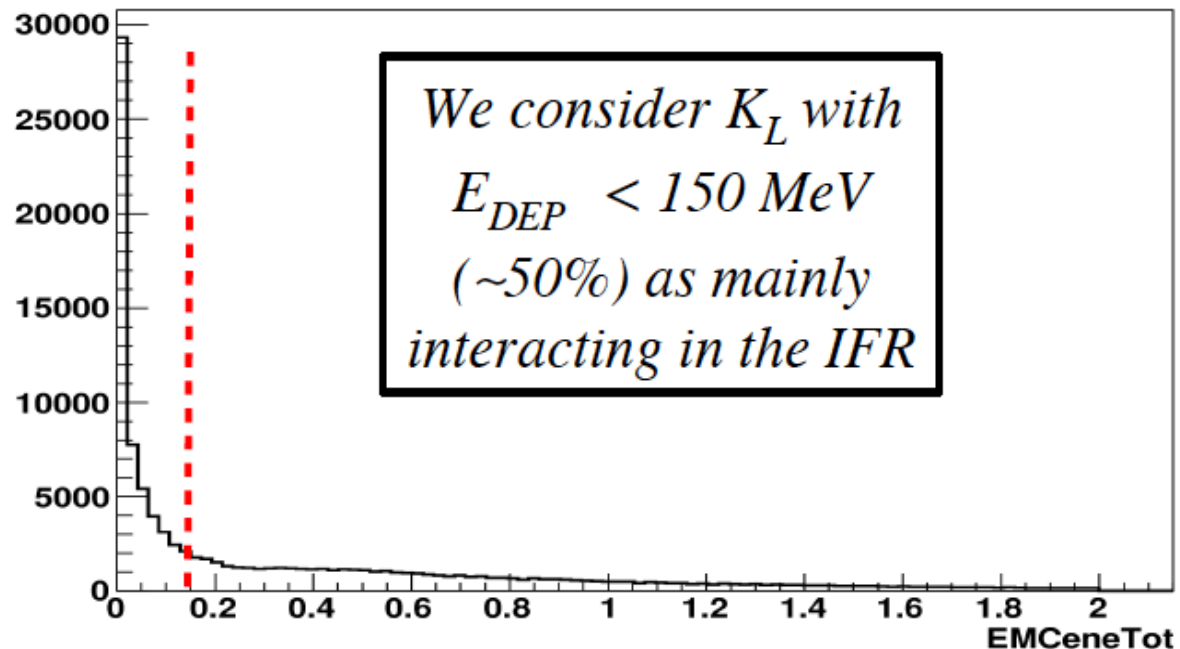

# $K_L$ : some distributions

- Distribution of the **first layer** hit, and the **last layer** hit

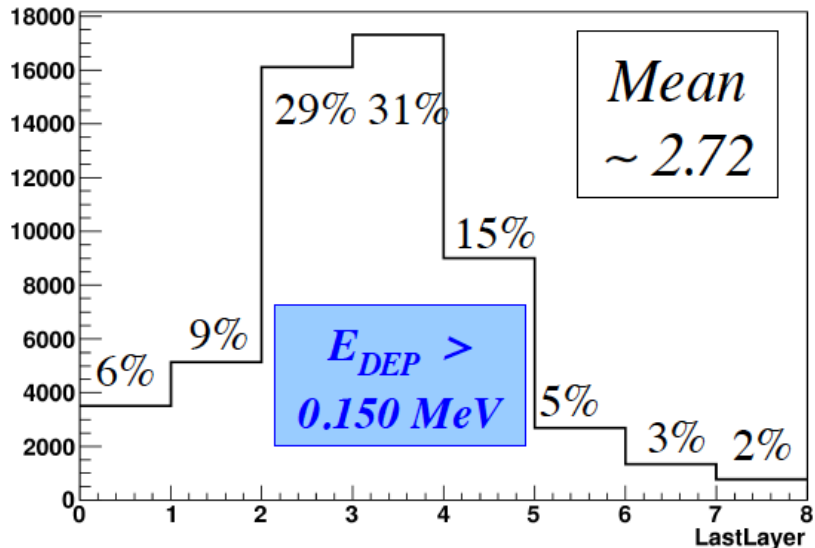
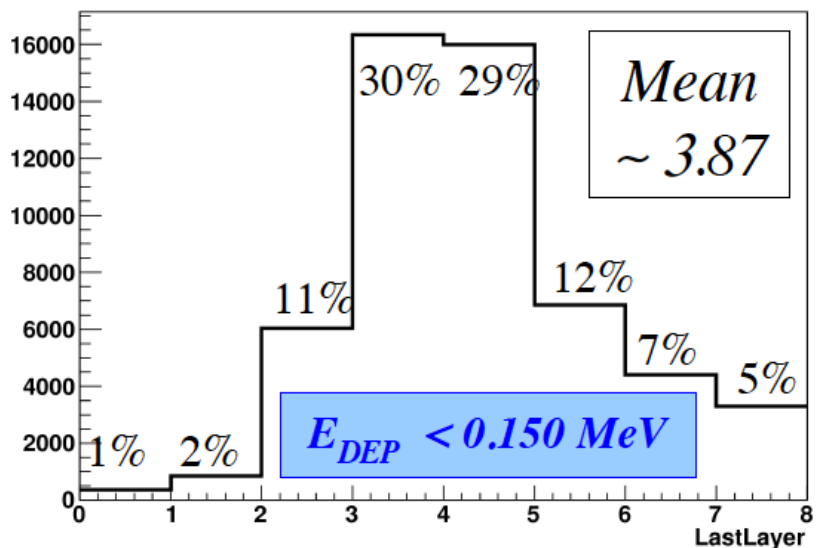
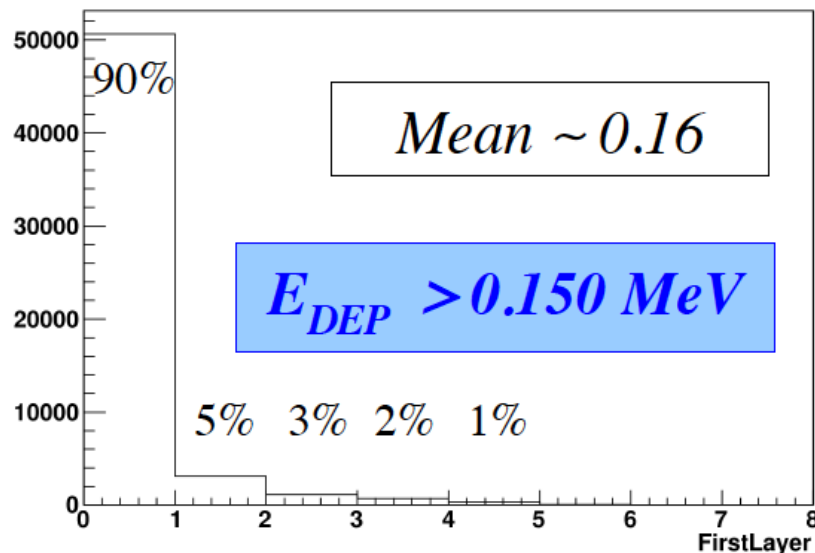
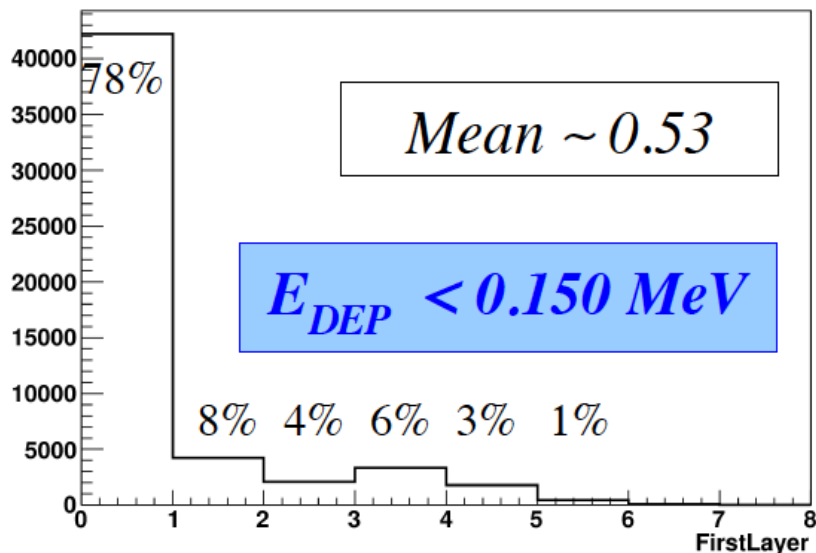

# $K_L$ cluster size

- Analyzing the distribution of LastLayer-FirstLayer as function of the momentum is possible to infer the  $K_L$  cluster size (iron cm)
- Different  $K_L$  cluster size depending by  $E_{DEP}$

LastBin-FirstBin VS TrkP

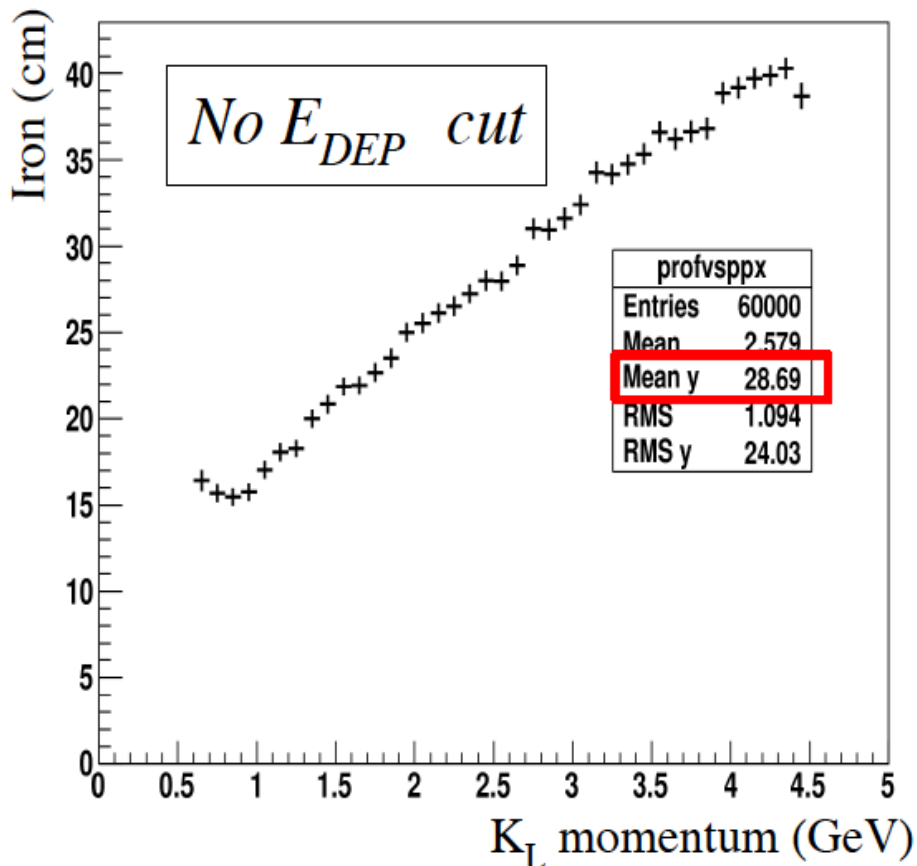

LastBin-FirstBin VS TrkP

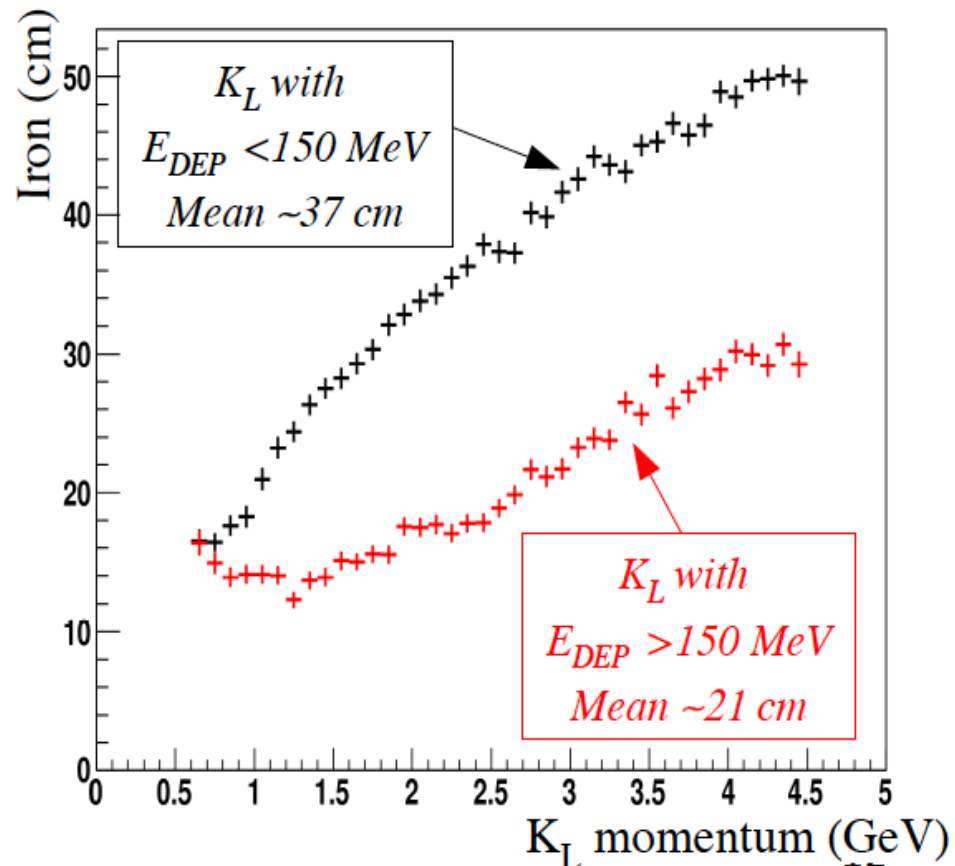

# Basic $K_L$ Selector

- Designed a  $K_L$  selector in order to compare 8L and 9L configurations
- Require  $K_L$  with  $E_{DEP} < 0.150$  MeV and an enough number of consecutive layers
- Study the  $K_L$  selection efficiency as function of the momentum

Configuration with 8 layers

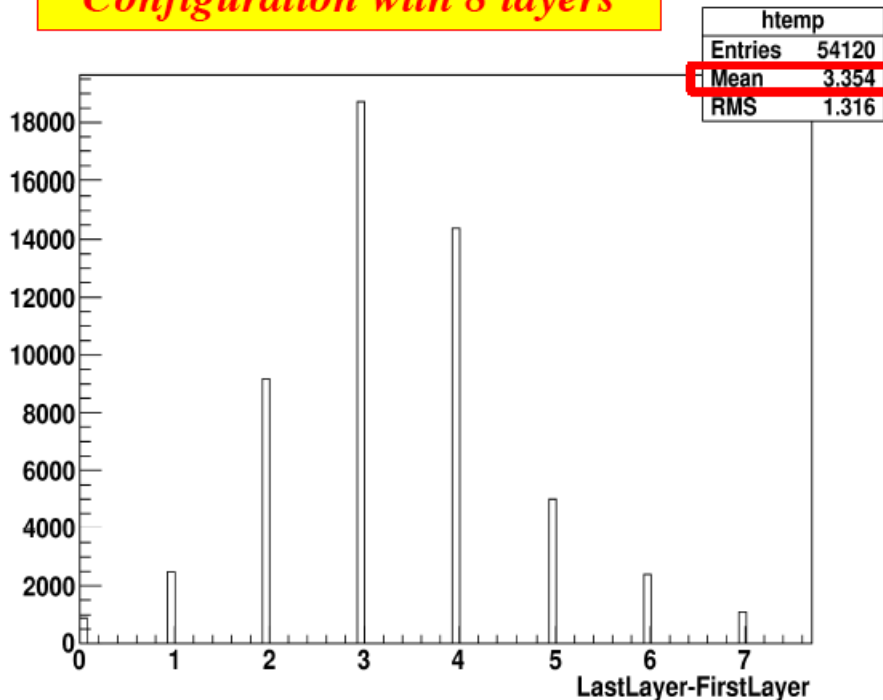

Configuration with 9 layers

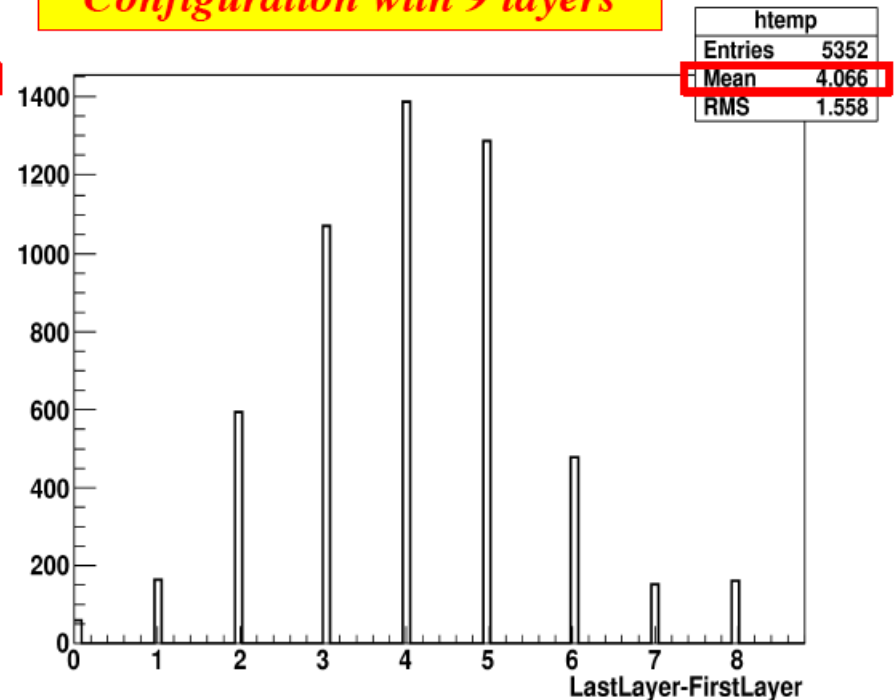

# $K_L$ : Efficiency .vs. Momentum

- Requiring at least 4 layers

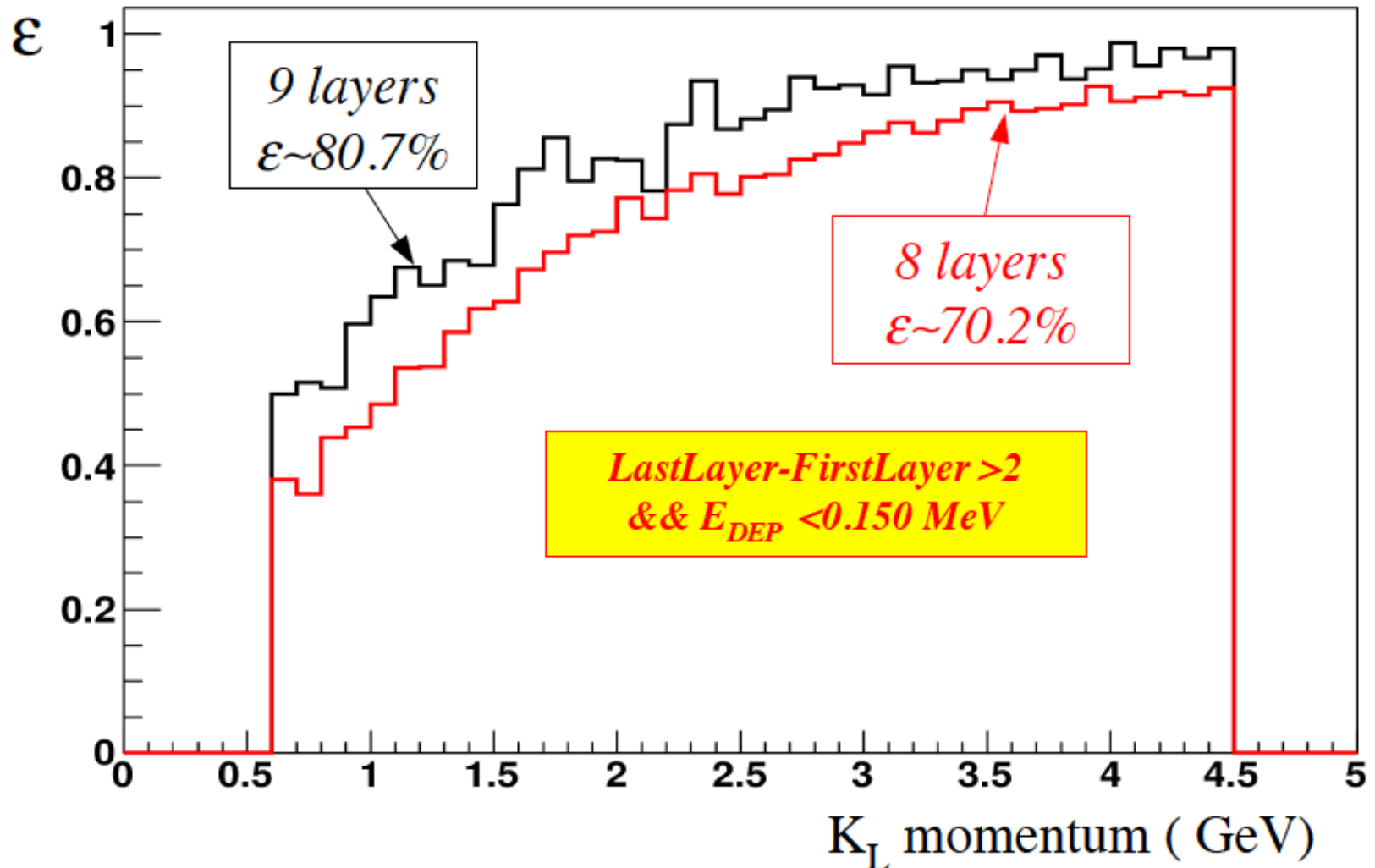

# $K_L$ : Efficiency .vs. Momentum

- Requiring at least 5 layers: the cut will depend on the background level/relevance

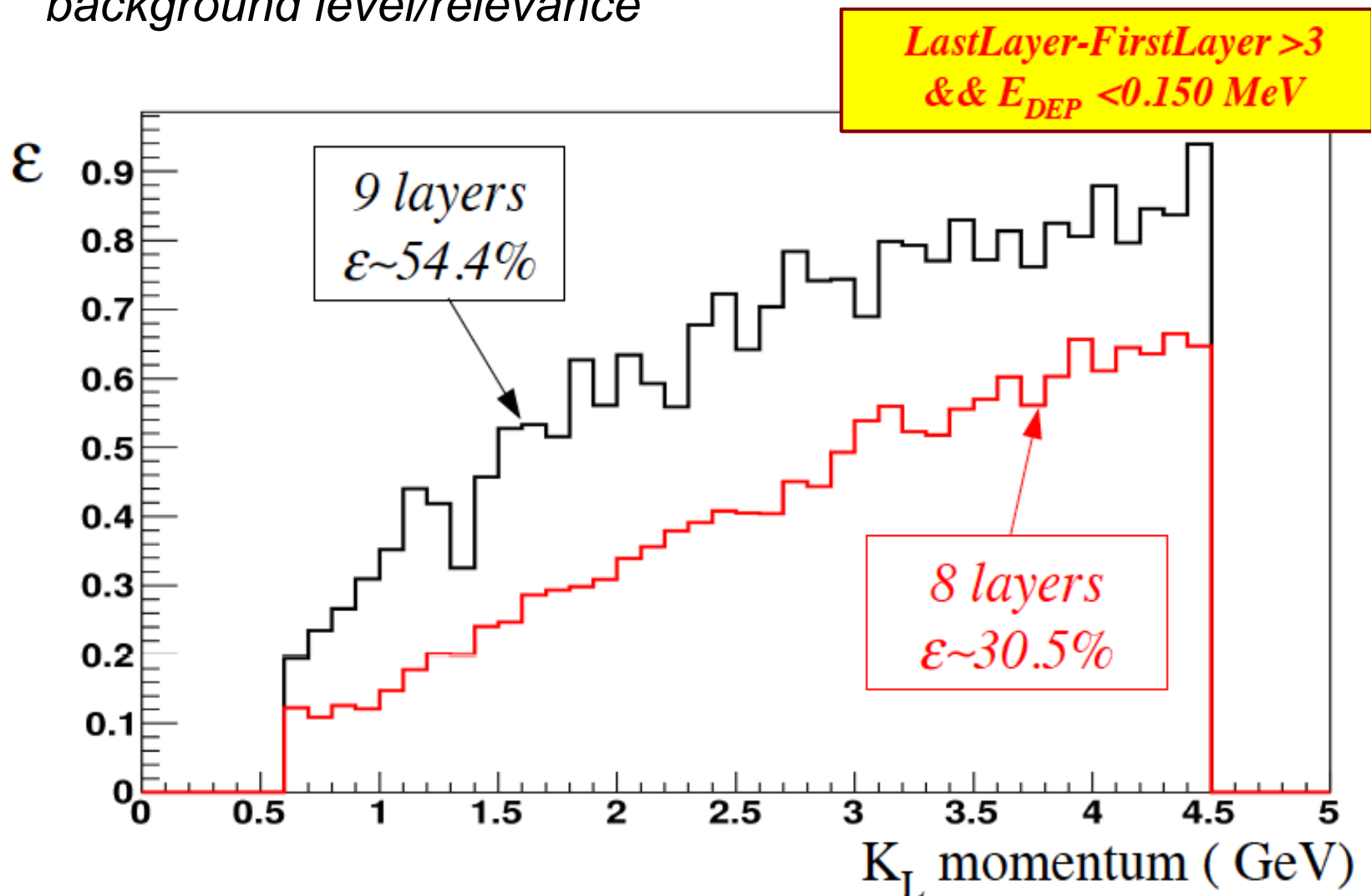

# To do list

- *Finalize the optimization studies for  $\mu$ - $\pi$  separation*
  - *Preliminary studies show an extra layer doesn't improve the  $\mu$  efficiency if we require high  $\pi$  suppression (misID=2%)*
  - *Write PID tables and replace the BaBar ones used at present in FastSim: study of specific physics channels are crucial to optimize the iron in the IFR*
- *$K_L$  studies just started:*
  - *About 50% interact within the IFR*
  - *Simple selector to compare various configurations: we should also start to look at lateral size of the  $K_L$  clusters*
  - *Preliminary studies show that for  $K_L$  the number of layers could be important*
  - *Crucial to start to look at realistic source of backgrounds:*
    - *Machine bkg, hard  $\gamma$ , pions*





# Muon momentum from $B \rightarrow D$ semileptonic decay

- Momentum distribution in SuperB are different from BaBar due to the change in the boost

Muon ID depends by the Event kinematics

Different boost play an Important role on the Angular momentum Distribution

Study the impact of various IFR Configurations On physics channel:  
- channel that require high Efficiency  
- channel that require high  $\pi \rightarrow \mu$  rejection

