

# IFR background analysis status report

Gianluigi Cibinetto, Matteo Facchin, Mauro Munerato and Marcello Rotondo

Annency, 17 March 2010



# Outline

- 1 Introduction
- 2 Energy distributions
- 3 Rate distributions
- 4 Studies of hadronic shower in different physics lists
- 5 Conclusions

## Goal for this production

- understand differences between different physics lists, cuts and configurations.
- look for problems, missing stuff and improvements.
- tune the machinery and tools for background analysis.
- not really extract reliable rate numbers but look at the order of magnitudes.
- look for any additional information that can be useful to understand/remediate backgrounds.

**Thanks to the Full Simulation Core Group and the Production Team for their help!**

# IFR regions where the background can be an issue

- FWD endcap inner layers and small radii (it's the hottest region): neutrons, photons, electrons
- Barrel innermost layers: mostly neutrons. This is a crucial region because SiPM should go there.
- BWD endcap inner layers and small radii: BWD endcap outer layers should be shielded by the SOB and additional iron.
- FWD endcap outer layer for the beam halo (final focus simulated up to 3m from IP).

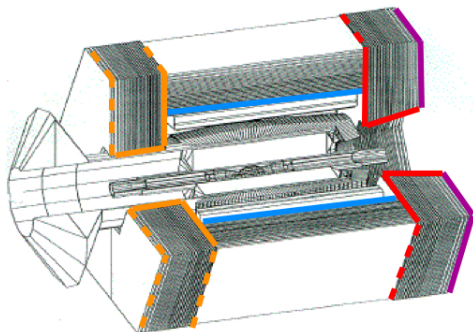

# The neutron path

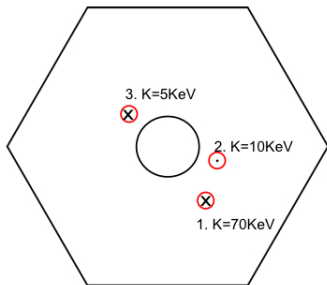
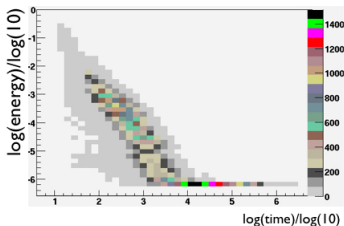

Figure: Example of neutron path in the endcap



**Neutron can cross the same layer more than once**

→ A neutron is generated in the final focus with a energy around 1MeV

→The neutron travels trough the inner detectors and enters the IFR FWD endcap in (1) with a kinetic energy of 70 keV.

→Then it exits and re-enters the endcap surface in (2) and (3) with subsequent energy degradation. Between (1) and (3) the elapsed time is about  $6\mu s$ .

→ The neutron generated in this event is only one, but it's counted 3 times in the boundary survey, and it also hit the first layer of the endcap 3 times with different energy.

⇐ Energy degradation vs time

# Neutron damage on silicon devices

The silicon damage function has a strong dependence on the energy spectrum therefore to obtain useful rate estimation we need to scale the doses to 1MeV equivalent accordingly to ASTM E 722 - 93.

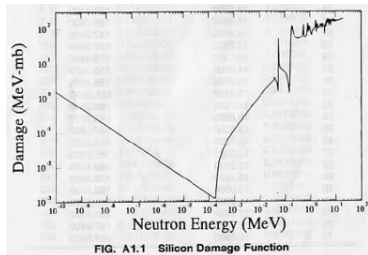
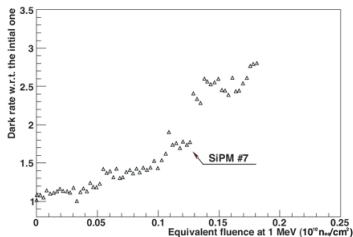

## 5. Conclusion

Several Silicon Photo-Multipliers have been exposed to an intense neutron flux integrating up to a total fluence of  $7.32 \times 10^{16} n_{eq}/cm^2$ . Their performance were for the first time studied before, during and after the irradiation thanks to the use of a controlled neutron source (the ENEA FNG). The drawn currents were found to increase up to a factor 30 while the dark counts up to 300. The detection efficiency measured with cosmic rays, drop from above 95% to around 75%. From the measurements shown we conclude that Silicon Photo-Multipliers performance would start deteriorating after an irradiation of few  $10^8 n_{eq}/cm^2$ . A dedicated experiment at so low rates is being planned in order to better quantify the break-down fluence.

From arXiv:1002.3480v1

- "New Snowmass Year" having  $1.5 \cdot 10^7$  seconds.
- BaBar simulation was 10 times below the measurement: at least a factor 10 of safety factor is likely to be taken into account

# Energy distributions

# Different cuts on DeltaE

The cuts on DeltaE doesn't affect the energy distribution on the neutron crossing the IFR.

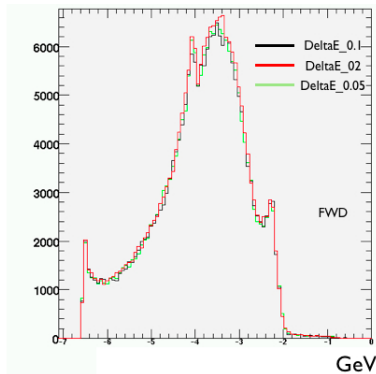
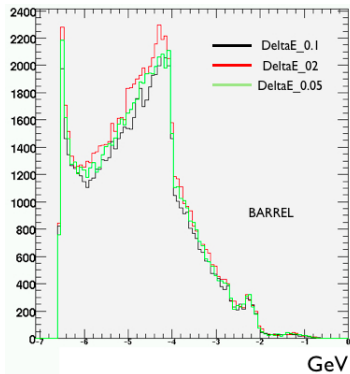

**Figure:** Energy distribution of neutron crossing the barrel and forward endcap boundary with log-scale



## Different physics lists

The hp list has a sizeable effect on the low energy neutron description.

Is the cut at  $\approx 10^{-3} \text{ MeV}$  physical or a reconstruction artifact?

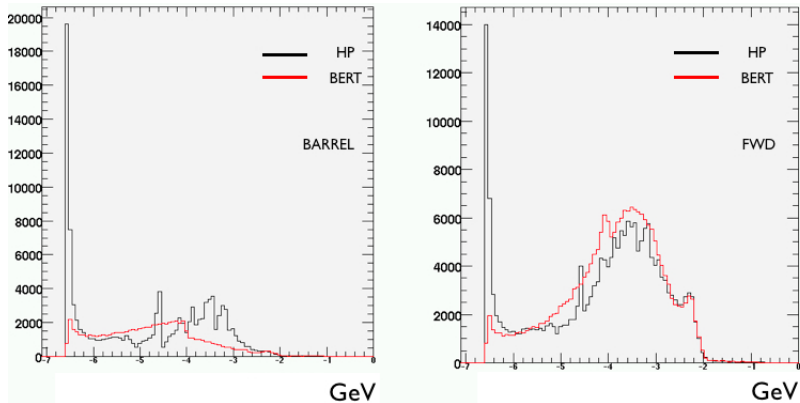

**Figure:** Energy distribution of neutron crossing the barrel and forward endcap boundary with log-scale

## Different configurations

The shielding is very powerful for electrons and photons but is also a good neutron generators

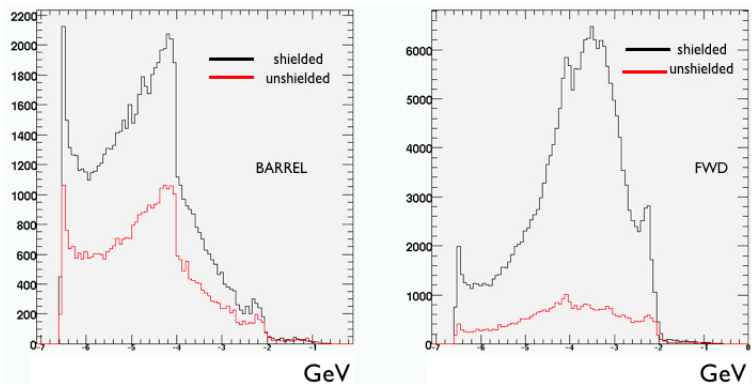

**Figure:** Energy distribution of neutron crossing the barrel and forward endcap boundary with log-scale

# Different configurations I

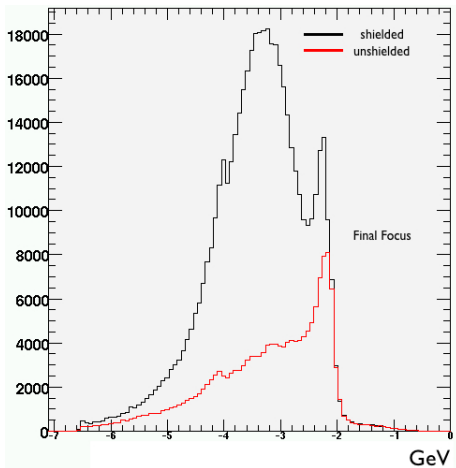
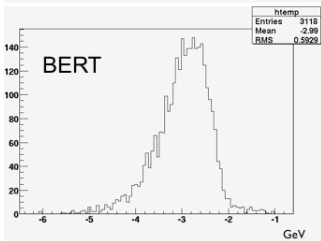
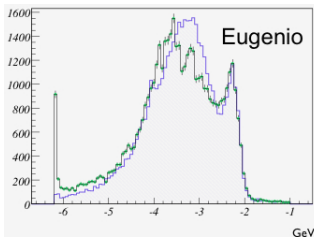
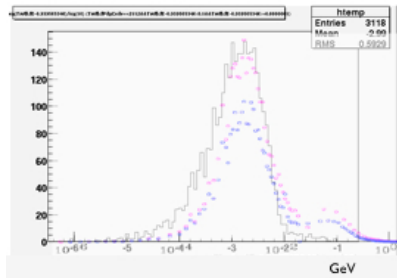

Figure: Energy distribution of neutron crossing the final focus boundary with log-scale

# Understanding Neutron Energy distributions



Eugenio spotted some differences between productions with 2 different physics lists: BERT vs HP. Some discrepancy is present also for generation energy of the few neutrons which have MC truth information in the rootfiles.



Good agreement between Super B simulation (MC truth generated energy) and Fluka simulation.

# Rate distributions

# Barrel Layer 0 rate

This is very important region because photodetectors will go inside the gaps.

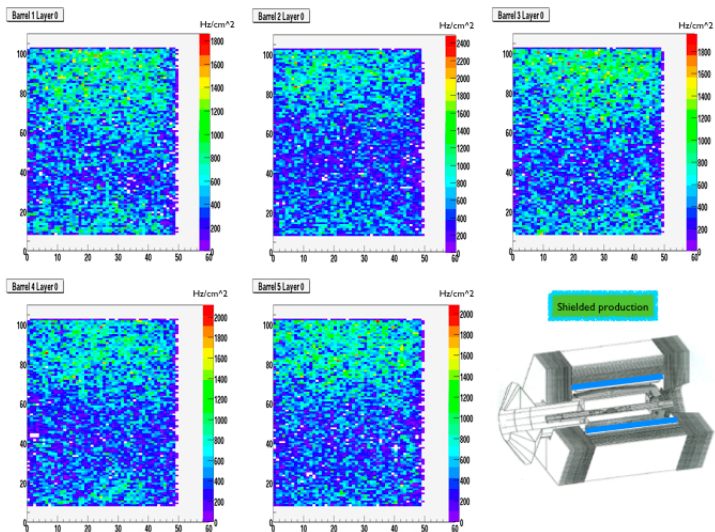

# Barrel Layer 0 rate Normalized to 1MeV energy

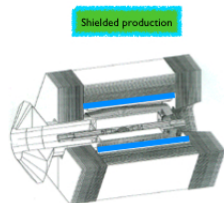
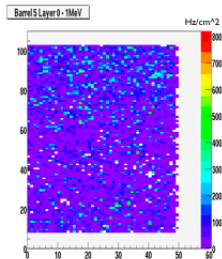
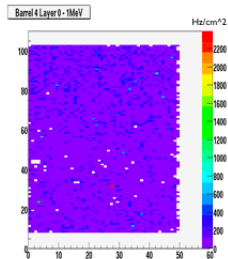
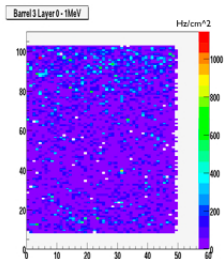
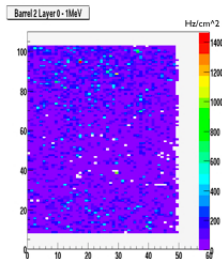
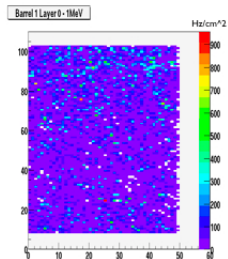

# Endcaps Layer 0 rate

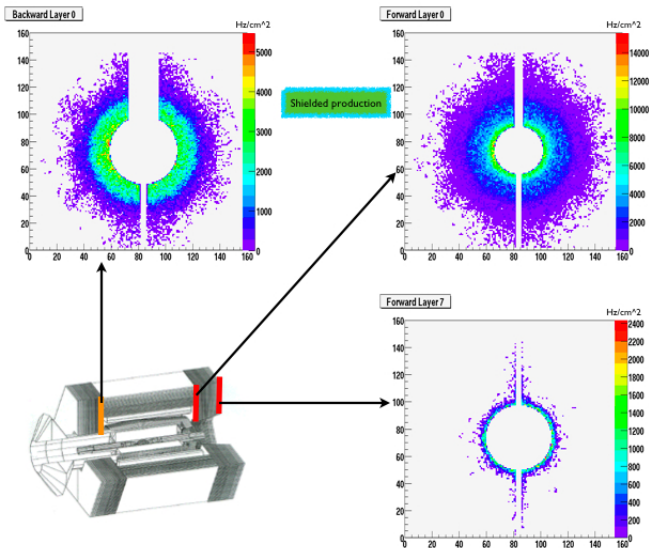

Maximum Rate  $\approx 10\text{KHz}$  but SiPMs will be located in the low rate region around the endcap.

the outermost layer of fwd endcap has a low rate because the final focus is simulated up to 3m from IP.



# Endcaps Layer 0 rate Normalized to 1MeV energy

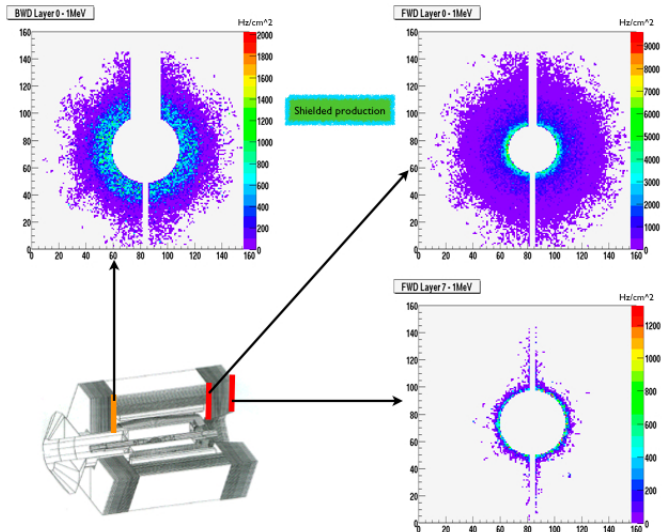

the outermost layer of fwd endcap has a low rate because the final focus is simulated up to 3m from IP.

# Shield vs Unshield

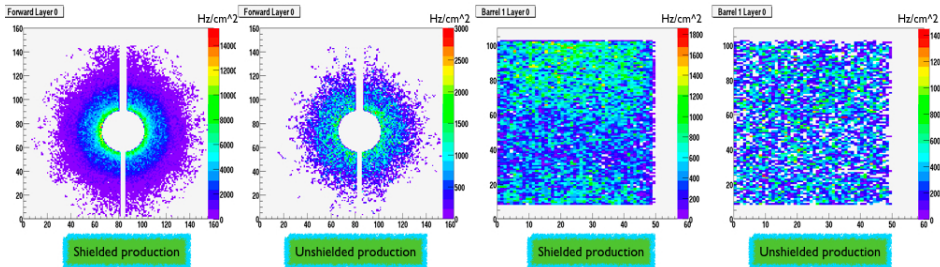
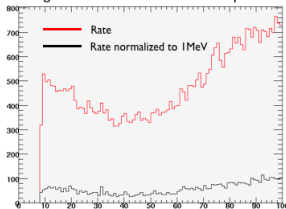
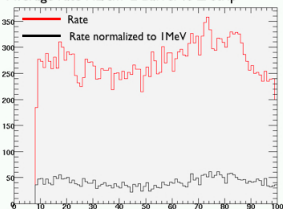
Average rate Hz/cm<sup>2</sup> Barrel vs Z-stripAverage rate Hz/cm<sup>2</sup> Barrel vs Z-strip

## BERT vs HP

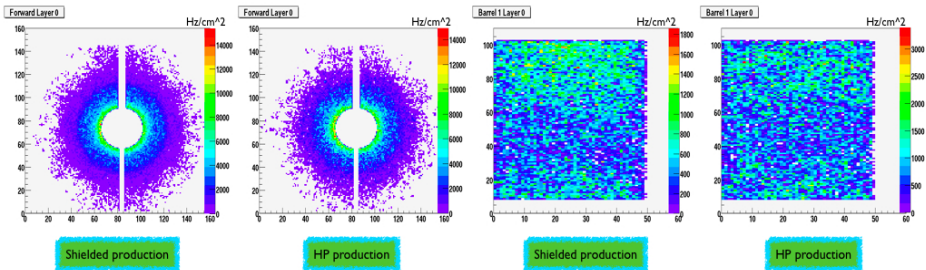
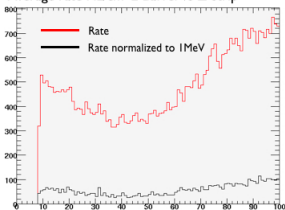
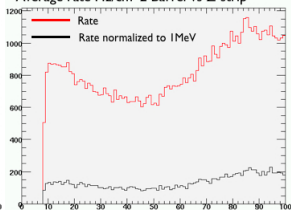
Average rate Hz/cm<sup>2</sup> Barrel vs Z-stripAverage rate Hz/cm<sup>2</sup> Barrel vs Z-strip

# Hot Spot

Looking at the final focus from the FWD side

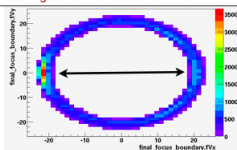

Looking at the final focus from the side

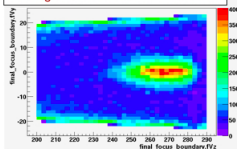

Looking at the final focus from above

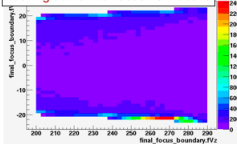

- The hot spot is visible in all the projections of the final focus (3 left plots).
- The rate of the hot spot is of the order of  $100\text{kHz}/\text{cm}^2$ , more than six times higher than the same region on the opposite side as denoted by the black arrow on the upper-left plot.
- There is a similar spot (wider along the beam pipe direction) about 1.5 m backward from the IP.
- The effect of this source is visible also on the inner ring of the IFR forward endcap (bottom center plot): the left half has higher rate.
- It seems to be an effect of the Wolf-Shield since such effect disappears in the unshielded production (bottom right).
- B.t.w. the maximum neutron rate on the IFR endcap inner ring with the shielding is almost one order of magnitude higher wrt the non-shielded configuration.
- The energy distributions are pretty much consistent to the ones showed before.
- Anyway the neutron rate produced by the spot doesn't drive the total final focus rate.

IFR FWD endcap (shielded)

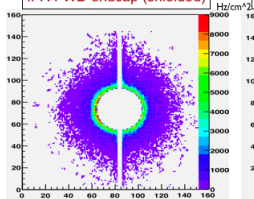

IFR FWD endcap (unshielded)

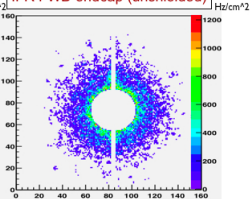

# Hadronic shower

# InteractionLength(left) and LastLayer(right) for different physics list

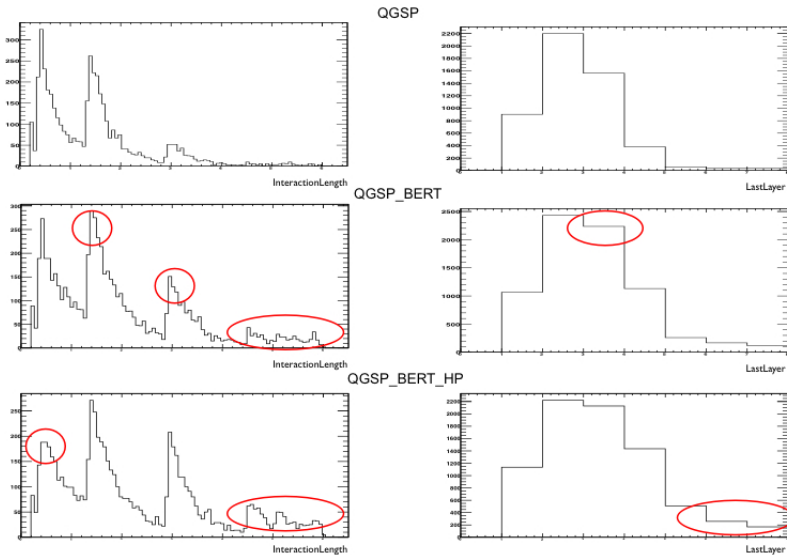

# InteractionLength vs momentum track for different physics lists

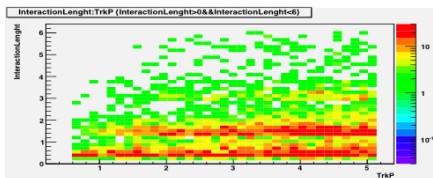

QGSP

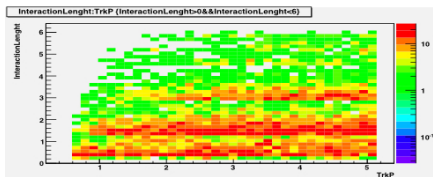

QGSP\_BERT

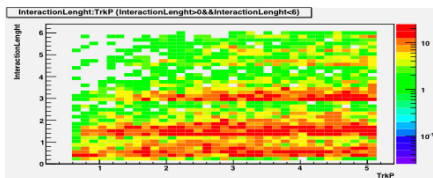

QGSP\_BERT\_HP

# Distribution for hit multiplicity(left) and deviation standard hit multiplicity(right) for different physics list

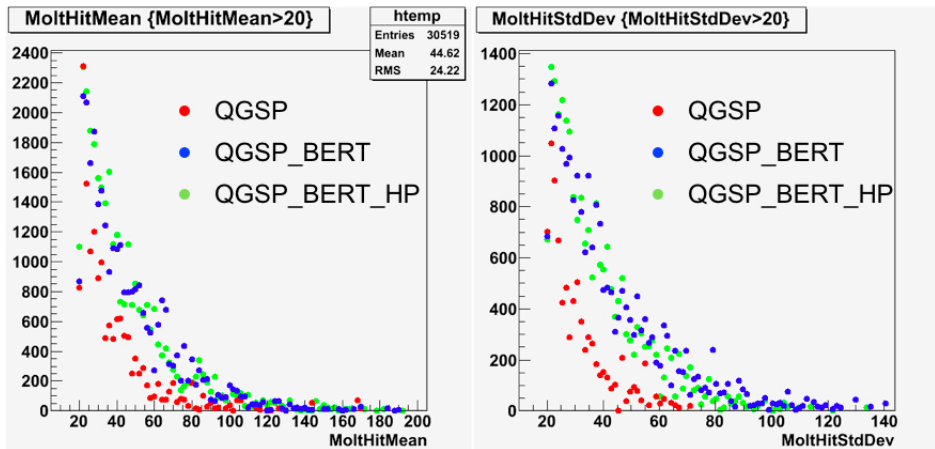



# Conclusions

For a better understanding of the neutron background:

- Results on neutron rate and energy distributions has been showed
- The analysis must be considered a preliminary approach because of some missing informations (MC truth), limited description of the final focus, cut at  $10\mu s$  of the neutron life and complexity of the problem.
- From this data it appears that neutron rate on the inner layers of the barrel is more than one order of magnitude above the tolerable threshold for the SiPMs without considering any safety factor.