

# Shockwaves, TMD distributions and BFKL

Renaud Boussarie

Brookhaven National Laboratory

REF 2019

[Altinoluk, RB, Kotko], JHEP 1905 (2019) 156

[Altinoluk, RB], JHEP 1910 (2019) 208

[RB, Mehtar-Tani]

# QCD at moderate $x$

$$Q^2 \sim s$$

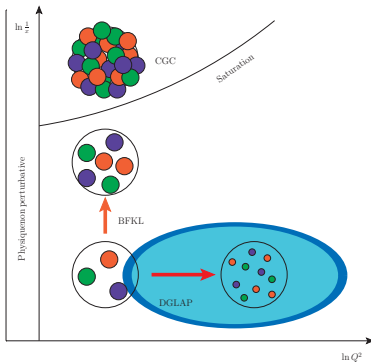

# Parton Distributions

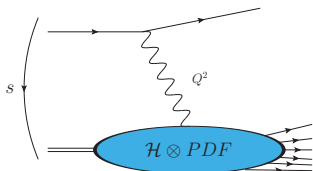

Parton Distribution Function (PDF)

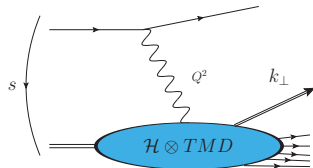
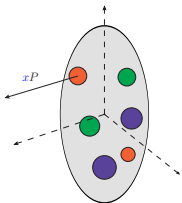

Transverse Momentum Dependent distributions (TMD)

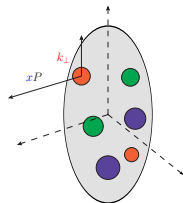

## Operator definition for parton distributions

## Parton distribution function

$$\mathcal{F}(x) \propto \int dz^+ e^{ixP^- z^+} \langle P | F^{-i}(z^+) [z^+, 0^+] F^{-i}(0) [0^+, z^+] | P \rangle$$

## Transverse Momentum Dependent distribution

$$\mathcal{F}(x, k_\perp) \propto \int d^4 z \delta(z^-) e^{ixP^- z^+ + i(k_\perp \cdot z_\perp)} \langle P | F^{-i}(z) \mathcal{U}_{z,0} F^{-i}(0) \mathcal{U}_{0,z} | P \rangle$$

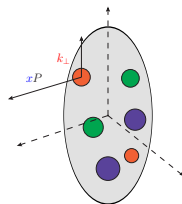
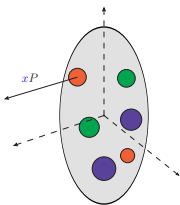

(So-called) **non-universality** of TMD  
distributions:  
The importance of gauge links

[Collins, Soper, Sterman], [Brodsky, Hwang, Schmidt], [Belitsky, Ji, Yuan],  
[Bomhof, Mulders, Pijlman], [Boer, Mulders, Pijlman]

[Kharzeev, Kovchegov, Tuchin]

## TMD gauge links

## "Non-universality" of quark TMD distributions

Gauge links can be **future-pointing** or **past-pointing**

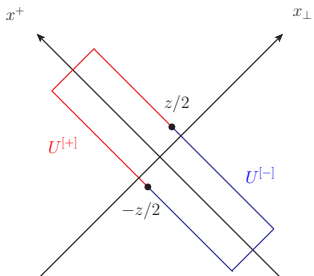

$$q^{[+]}(x, k_{\perp}) \propto \langle P, S | \bar{\psi} \left( \frac{z}{2} \right) \mathcal{U}_{\frac{z}{2}, -\frac{z}{2}}^{[+]} \psi \left( -\frac{z}{2} \right) | P, S \rangle$$

$$q^{[-]}(x, k_{\perp}) \propto \langle P, S | \bar{\psi} \left( \frac{z}{2} \right) \mathcal{U}_{\frac{z}{2}, -\frac{z}{2}}^{[-]} \psi \left( -\frac{z}{2} \right) | P, S \rangle$$

For naive T-odd distributions,  $q^{[+]} = -q^{[-]}$

# The Sivers effect

## SIDIS

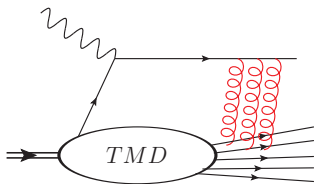

## Drell-Yan

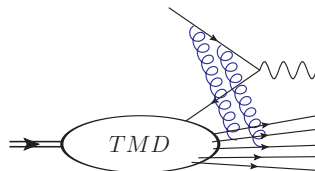

Final state interactions:  $q^{[+]}$

Initial state interactions:  $q^{[-]}$

The **Sivers distribution** comes with a **relative – sign** between SIDIS and DY: different **gauge links** for a **naive T-odd** quantity!

## TMD gauge links

## "Non-universality" of gluon TMD distributions

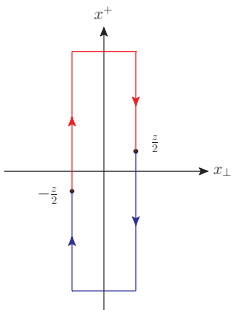

$$\text{Tr} \left[ F^{i-} \left( \frac{Z}{2} \right) \mathcal{U}^{[-]\dagger} F^{i-} \left( -\frac{Z}{2} \right) \mathcal{U}^{[+]} \right]$$

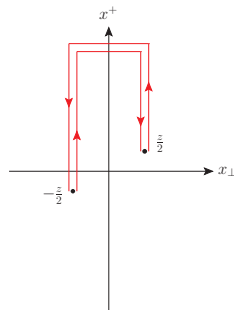

$$\text{Tr} \left[ F^{i-} \left( \frac{Z}{2} \right) \mathcal{U}^{[+]\dagger} F^{i-} \left( -\frac{Z}{2} \right) \mathcal{U}^{[+]} \right]$$



## TMD gauge links

## "Non-universality" of gluon TMD distributions

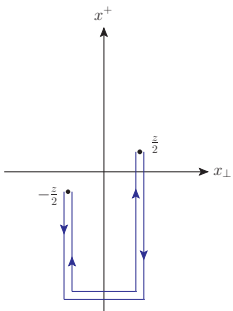

$$\text{Tr} \left[ F^{i-} \mathcal{U}^{[-]\dagger} F^{i-} \mathcal{U}^{[-]} \right]$$

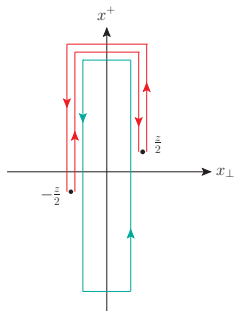

$$\text{Tr} \left[ F^{i-} \mathcal{U}^{[+]\dagger} F^{i-} \mathcal{U}^{[+]} \right] \text{Tr} \left[ \mathcal{U}^{[\square]} \right]$$

## TMD gauge links

## "Non-universality" of gluon TMD distributions

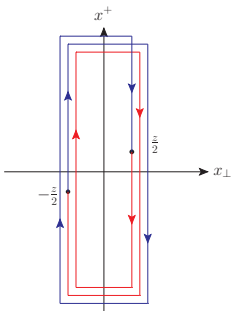

$$\text{Tr} \left[ F^{i-} u^{[\square] \dagger} u^{[+] \dagger} F^{i-} u^{[\square]} u^{[+]} \right]$$

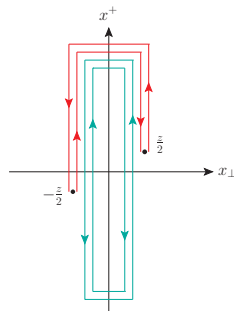

$$\text{Tr} \left[ F^{i-} u^{[+] \dagger} F^{i-} u^{[+]} \right] \text{Tr} \left[ u^{[\square]} \right] \text{Tr} \left[ u^{[\square] \dagger} \right]$$

QCD at small  $x$ 

$$Q^2 \ll s$$

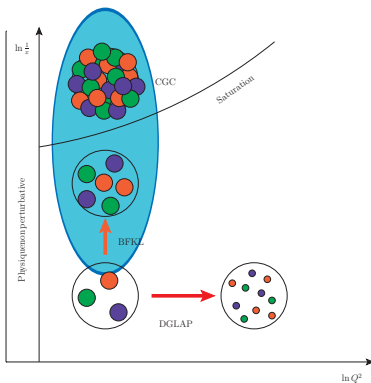

## Rapidity separation

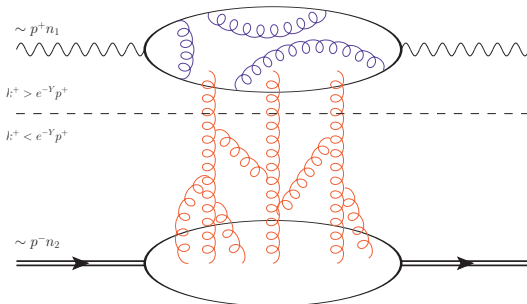

Let us split the gluonic field between "fast" and "slow" gluons

$$\begin{aligned} \mathcal{A}^{\mu a}(k^+, k^-, \vec{k}) &= A_{Y_c}^{\mu a}(|k^+| > e^{-Y_c} p^+, k^-, \vec{k}) \\ &+ b_{Y_c}^{\mu a}(|k^+| < e^{-Y_c} p^+, k^-, \vec{k}) \end{aligned}$$

$$e^{-Y_c} \ll 1$$

# Large longitudinal boost to the projectile frame

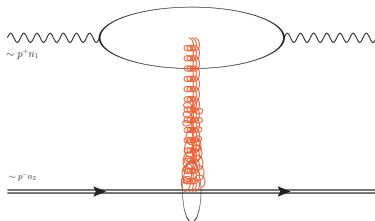
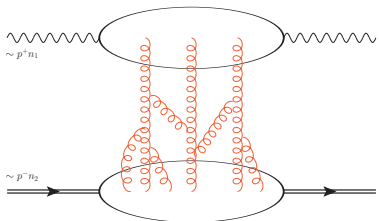

$$b^+(x^+, x^-, \vec{x})$$

$$b^-(x^+, x^-, \vec{x})$$

$$b^k(x^+, x^-, \vec{x})$$

→

$$\frac{1}{\Lambda} b^+(\Lambda x^+, \frac{x^-}{\Lambda}, \vec{x})$$

$$\Lambda b^-(\Lambda x^+, \frac{x^-}{\Lambda}, \vec{x})$$

$$b^k(\Lambda x^+, \frac{x^-}{\Lambda}, \vec{x})$$

$$\Lambda \sim \sqrt{\frac{s}{m_t^2}}$$

$$b^\mu(x) \rightarrow b^-(x) n_2^\mu = \delta(x^+) \mathbf{B}(\vec{x}) n_2^\mu + O(\sqrt{\frac{m_t^2}{s}})$$

Shockwave approximation

# Effective Feynman rules in the slow background field

The interactions with the background field can be **exponentiated**

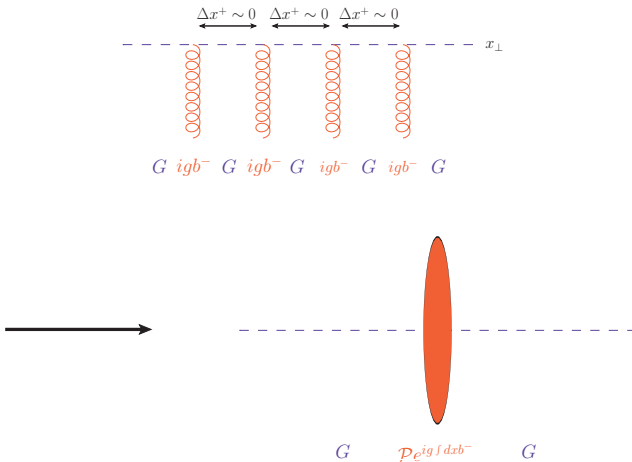

## Factorized picture

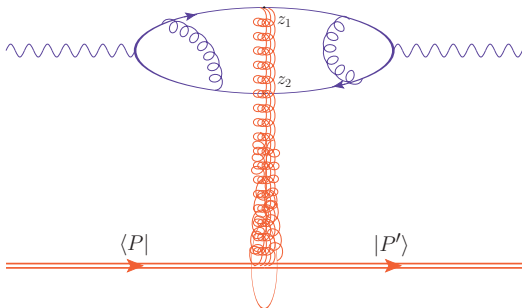

Factorized amplitude

$$\mathcal{A}^{Y_c} = \int d^{D-2} \vec{z}_1 d^{D-2} \vec{z}_2 \Phi^{Y_c}(\vec{z}_1, \vec{z}_2) \langle P' | [\text{Tr}(U_{\vec{z}_1}^{Y_c} U_{\vec{z}_2}^{Y_c \dagger}) - N_c] | P \rangle$$

$$\text{Dipole operator } U_{ij}^{Y_c} = \frac{1}{N_c} \text{Tr}(U_{\vec{z}_i}^{Y_c} U_{\vec{z}_j}^{Y_c \dagger}) - 1$$

Written similarly for any number of Wilson lines in any color representation!

# Evolution for the dipole operator

$$U_{12}^{Y_c + \delta Y} - U_{12}^{Y_c}$$

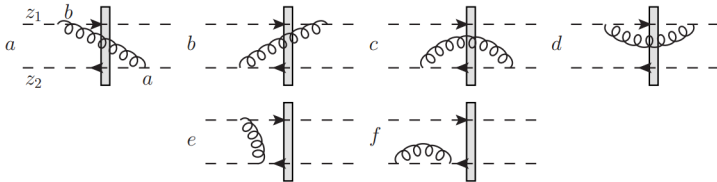

B-JIMWLK hierarchy of equations

[Balitsky, Jalilian-Marian, Iancu, McLerran, Weigert, Leonidov, Kovner]

$$\frac{\partial U_{12}^{Y_c}}{\partial Y_c} = \frac{\alpha_s N_c}{2\pi^2} \int d\vec{z}_3 \frac{\vec{z}_{12}^2}{z_{13}^2 z_{23}^2} \left[ U_{13}^{Y_c} + U_{32}^{Y_c} - U_{12}^{Y_c} + U_{13}^{Y_c} U_{32}^{Y_c} \right]$$

$$\frac{\partial U_{13}^{Y_c} U_{32}^{Y_c}}{\partial Y_c} = \dots$$

Evolves a dipole into a double dipole



# The BK equation

Mean field approximation, or 't Hooft planar limit  $N_c \rightarrow \infty$  in the dipole B-JIMWLK equation

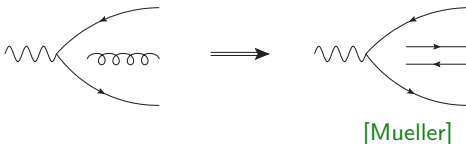

⇒ **BK equation** [Balitsky, 1995] [Kovchegov, 1999]

$$\frac{\partial \langle u_{12}^{Y_c} \rangle}{\partial Y_c} = \frac{\alpha_s N_c}{2\pi^2} \int d\vec{z}_3 \frac{z_{12}^2}{z_{13}^2 z_{23}^2} \left[ \langle u_{13}^{Y_c} \rangle + \langle u_{32}^{Y_c} \rangle - \langle u_{12}^{Y_c} \rangle + \langle u_{13}^{Y_c} \rangle \langle u_{32}^{Y_c} \rangle \right]$$

BFKL/BKP part

Triple pomeron vertex

Non-linear term : one type of **saturation**

Non-perturbative elements are **compatible with CGC-type models**

# The seemingly incompatible nature of the distributions

## Two different kinds of gluon distributions

### Moderate $x$ distributions

### Low $x$ distributions

GTMD, GPD, TMD, PDF...

Dipole scattering amplitude

$$\langle P^{(r)} | F^{-i} W F^{-j} W | P \rangle$$

$$\langle P^{(r)} | \text{tr}(U_1 U_2^\dagger) | P \rangle$$

# TMD distributions from QCD shockwaves

## From the CGC to a TMD

From Wilson lines...



$$\langle P | \text{Tr} \left( U_{\frac{r}{2}} U_{-\frac{r}{2}}^\dagger \right) | P \rangle$$

To a parton distribution

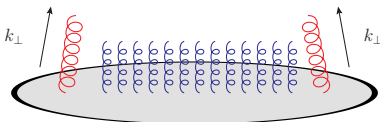

$$\langle P | \text{Tr} \left( \partial^i U_{\frac{r}{2}} \partial^i U_{-\frac{r}{2}}^\dagger \right) | P \rangle$$

## From the CGC to a TMD

## Staple gauge links from a Wilson line operator

[Dominguez, Marquet, Xiao, Yuan]

Consider the **derivative of a path-ordered Wilson line**, denoting

$$[x_1^+, x_2^+]_{\vec{x}} \equiv \mathcal{P} \exp \left[ ig \int_{x_1^+}^{x_2^+} dx^+ b^-(x^+, \vec{x}) \right]$$

For a given shockwave operator  $U_{\vec{x}} = [-\infty, +\infty]_{\vec{x}}$ 

$$\partial^i U_{\vec{x}} = ig \int dx^+ [-\infty, x^+]_{\vec{x}} F^{-i}(x^+, \vec{x}) [x^+, +\infty]_{\vec{x}}$$

$$\partial^j U_{\vec{x}}^\dagger = -ig \int dx^+ [+ \infty, x^+]_{\vec{x}} F^{-j}(x^+, \vec{x}) [x^+, -\infty]_{\vec{x}}$$

$$(\partial^i U_{\vec{x}}^\dagger) U_{\vec{x}} = -ig \int dx^+ [+ \infty, x^+]_{\vec{x}} F^{-i}(x^+, \vec{x}) [x^+, +\infty]_{\vec{x}}$$

Taking the **derivative** of a shockwave operator allows to extract a **physical gluon**

## From the CGC to a TMD

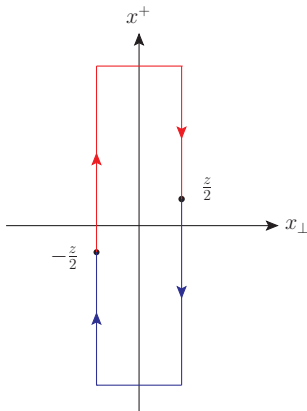
The **dipole** TMD

$$\mathcal{F}_{qg}^{(1)}(x, k_{\perp}) \propto \int d^4 z \delta(z^+) e^{ix(P \cdot z) + i(k_{\perp} \cdot z_{\perp})} \langle P | \text{Tr} \left[ F^{i-} \left( \frac{z}{2} \right) \mathcal{U}^{[-] \dagger} F^{i-} \left( -\frac{z}{2} \right) \mathcal{U}^{[+] } \right] | P \rangle$$

$$\rightarrow \int d^2 z_{\perp} e^{i(k_{\perp} \cdot z_{\perp})} \langle P | \text{Tr} \left[ \left( \partial^i U_{\frac{z}{2}}^{\dagger} \right) \left( \partial^i U_{-\frac{z}{2}} \right) \right] | P \rangle$$

## From the CGC to a TMD

## The Weizsäcker-Williams TMD

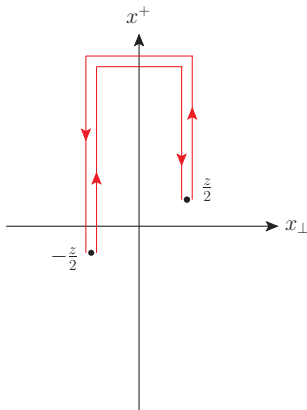

$$\mathcal{F}_{gg}^{(3)}(x, k_\perp) \propto \int d^4 z \delta(z^+) e^{ix(P \cdot z) + i(k_\perp \cdot z_\perp)} \langle P | \text{Tr} \left[ F^{i-} \left( \frac{z}{2} \right) \mathcal{U}^{[+] \dagger} F^{i-} \left( -\frac{z}{2} \right) \mathcal{U}^{[+]} \right] | P \rangle$$

$$\rightarrow \int dz_\perp e^{i(k_\perp \cdot z_\perp)} \langle P | \text{Tr} \left[ \left( \partial^i U_{\frac{z}{2}} \right) U_{-\frac{z}{2}}^\dagger \left( \partial^i U_{-\frac{z}{2}} \right) U_{\frac{z}{2}}^\dagger \right] | P \rangle$$

## General 1 → 2 process in the shockwave framework

Splitting of a particle into two particles in the external shockwave field

$$\mathcal{A} = (2\pi) \delta(p_1^+ + p_2^+ - p_0^+) \int d^2\mathbf{b} d^2\mathbf{r} e^{-i(\mathbf{q}\cdot\mathbf{r}) - i(\mathbf{k}\cdot\mathbf{b})} \mathcal{H}(\mathbf{r})$$

$$\times \left[ \left( U_{\mathbf{b}+\bar{z}\mathbf{r}}^{R_1} T^{R_0} U_{\mathbf{b}-z\mathbf{r}}^{R_2} \right) - \left( U_{\mathbf{b}}^{R_1} T^{R_0} U_{\mathbf{b}}^{R_2} \right) \right],$$

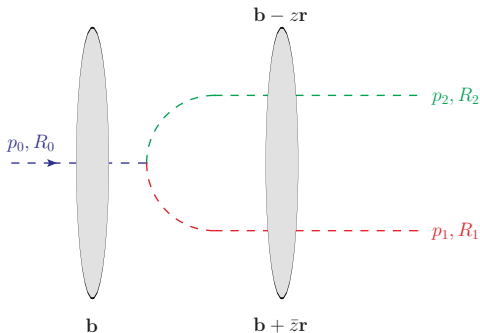



## Matching shockwave amplitudes and TMD amplitudes

[Altinoluk, RB]

We can cast the shockwave amplitude into a **1-body amplitude**

$$\mathcal{A}_1 = (2\pi) \delta(p_1^+ + p_2^+ - p_0^+) \int d^2 \mathbf{b} e^{-i(\mathbf{k} \cdot \mathbf{b})} (-i) \int d^2 \mathbf{r} e^{-i(\mathbf{q} \cdot \mathbf{r})} r_{\perp}^{\alpha} \mathcal{H}(\mathbf{r})$$

$$\times \left[ \left( \frac{e^{i\bar{z}(\mathbf{k} \cdot \mathbf{r})} - 1}{(\mathbf{k} \cdot \mathbf{r})} \right) (\partial_{\alpha} U_b^{R_1}) T^{R_0} U_b^{R_2} + \left( \frac{e^{-iz(\mathbf{k} \cdot \mathbf{r})} - 1}{(\mathbf{k} \cdot \mathbf{r})} \right) U_b^{R_1} T^{R_0} (\partial_{\alpha} U_b^{R_2}) \right]$$

and a **2-body amplitude**

$$\mathcal{A}_2 = (2\pi) \delta(p_1^+ + p_2^+ - p_0^+) \int \frac{d^2 \mathbf{k}_1}{(2\pi)^2} \frac{d^2 \mathbf{k}_2}{(2\pi)^2} (2\pi)^2 \delta^2(\mathbf{k}_1 + \mathbf{k}_2 - \mathbf{k})$$

$$\times \int d^2 \mathbf{b}_1 d^2 \mathbf{b}_2 e^{-i(\mathbf{k}_1 \cdot \mathbf{b}_1) - i(\mathbf{k}_2 \cdot \mathbf{b}_2)} (\partial^j U_{b_1}^{R_1}) T^{R_0} (\partial^j U_{b_2}^{R_2})$$

$$\times \left[ - \int d^2 \mathbf{r} e^{-i(\mathbf{q} \cdot \mathbf{r})} r^i r^j \mathcal{H}(\mathbf{r}) \left( \frac{e^{-iz(\mathbf{k} \cdot \mathbf{r})}}{(\mathbf{k} \cdot \mathbf{r})} \frac{e^{i(\mathbf{k}_1 \cdot \mathbf{r})} - 1}{(\mathbf{k}_1 \cdot \mathbf{r})} + \frac{e^{i\bar{z}(\mathbf{k} \cdot \mathbf{r})}}{(\mathbf{k} \cdot \mathbf{r})} \frac{e^{-i(\mathbf{k}_2 \cdot \mathbf{r})} - 1}{(\mathbf{k}_2 \cdot \mathbf{r})} \right) \right]$$

Inclusive low  $x$  cross section

Inclusive low  $x$  cross section = TMD cross section  
 [Altinoluk, RB, Kotko], [Altinoluk, RB]

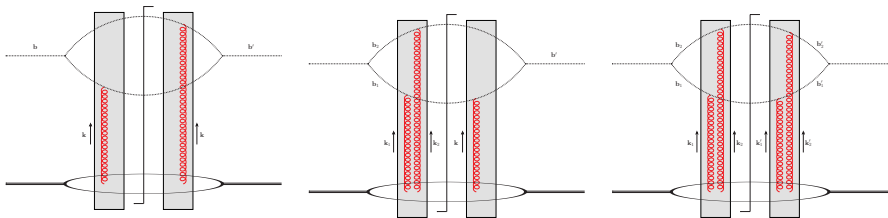

$$\begin{aligned} \sigma &= \mathcal{H}_2^{ij}(k_\perp) \otimes \langle P | F^{-i} W F^{-j} W | P \rangle \\ &+ \mathcal{H}_3^{ijk}(k_\perp, k_{1\perp}) \otimes \langle P | F^{-i} W g_s F^{-j} W F^{-k} W | P \rangle \\ &+ \mathcal{H}_4^{ijkl}(k_\perp, k_{1\perp}, k'_{1\perp}) \otimes \langle P | F^{-i} W g_s F^{-j} W g_s F^{-k} W F^{-l} W | P \rangle \end{aligned}$$

Exclusive low  $x$  cross section

Exclusive low  $x$  amplitude = GTMD amplitude  
[Altinoluk, RB]

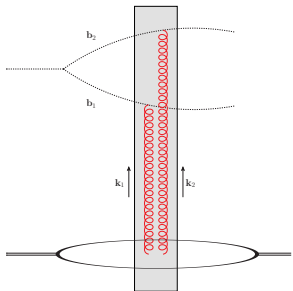

$$\mathcal{H}^{ij}(k_{1\perp}, k_{2\perp}) \otimes \langle P' | F^{-i} W F^{-j} W | P \rangle$$

Every exclusive low  $x$  process probes  
a **Wigner distribution!**

## Dijet electro- or photoproduction

## Weizsäcker-Williams TMD

$$T^{R_0} = 1, U^{R_1} = U, U^{R_2} = U^\dagger$$

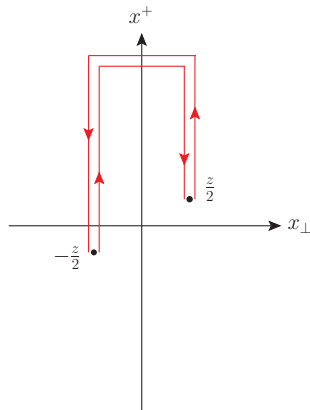
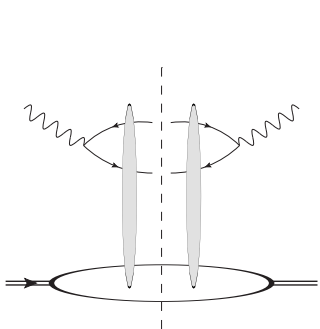

$$\mathcal{F}_{gg}^{(3)}(x \sim 0, k_\perp) \propto \int d^2 z_\perp e^{-i(k_\perp \cdot z_\perp)} \langle P | \text{Tr}(\partial^i U_{\frac{z}{2}}^\dagger) U_{\frac{z}{2}} (\partial^i U_{-\frac{z}{2}}^\dagger) U_{-\frac{z}{2}} | P \rangle$$

Jet+photon production in  $pA$  collisions

## Dipole TMD

$$T^{R_0} = 1, U^{R_1} = U, U^{R_2} = 1$$

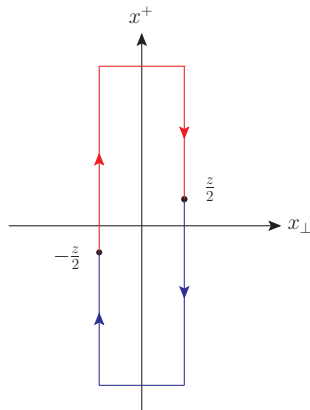
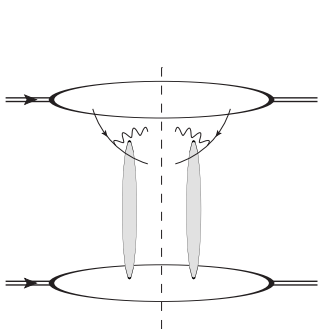

$$\mathcal{F}_{qg}^{(1)}(x \sim 0, k_\perp) \propto \int d^2 z_\perp e^{-i(k_\perp \cdot z_\perp)} \langle P | \text{tr}(\partial^i U_{\frac{z}{2}}) (\partial^i U_{-\frac{z}{2}}^\dagger) | P \rangle$$

# Forward dijet production in $pA$ collisions

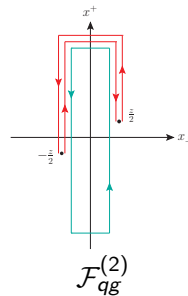
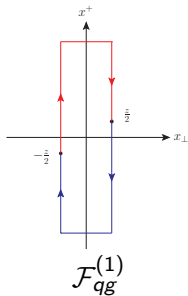
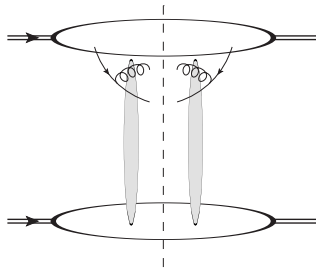

# Forward dijet production in $pA$ collisions

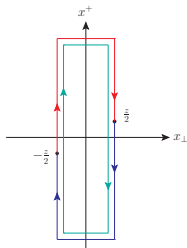
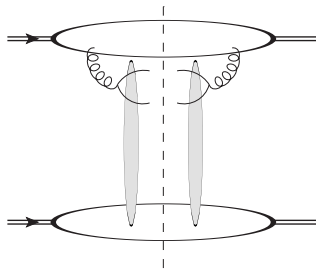
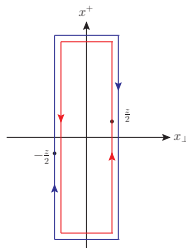
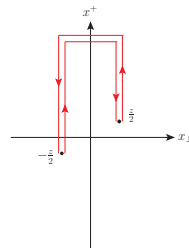
 $\mathcal{F}_{gg}^{(1)}$ 

 $\mathcal{F}_{gg}^{(2)}$ 

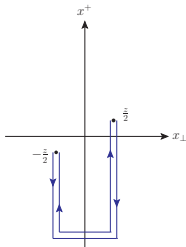
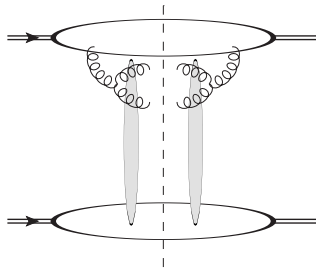
 $\mathcal{F}_{gg}^{(3)}$

# Forward dijet production in $pA$ collisions

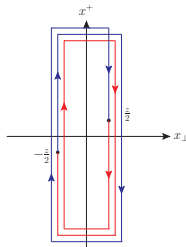

$$\mathcal{F}_{gg}^{(4)}$$



$$\mathcal{F}_{gg}^{(5)}$$

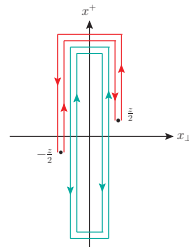

$$\mathcal{F}_{gg}^{(6)}$$



The so-called **dilute limit** in terms of TMD distributions

## The dilute limit

## The dilute limit in terms of TMD distributions

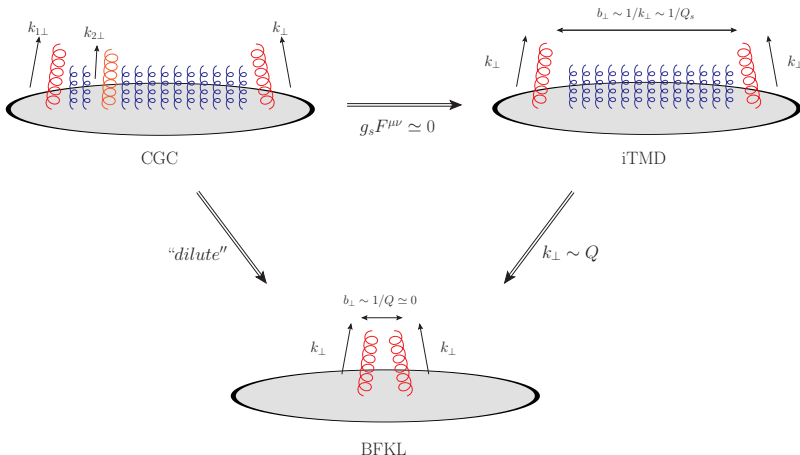

Two kinds of multiple scattering effects: **higher genuine twists** and **higher kinematic twists**

Inclusive low  $x$  cross section

First, take the Wandzura-Wilczek approximation

[Altinoluk, RB, Kotko]: matches iTMD cross sections

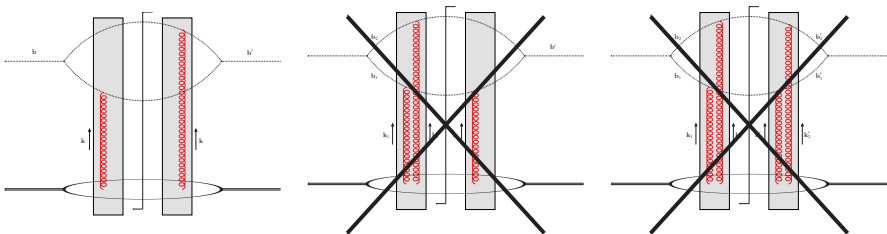

$$\begin{aligned} \sigma &= \mathcal{H}_2^{ij}(k_\perp) \otimes \langle P | F^{-i} W F^{-j} W | P \rangle \\ &+ \mathcal{H}_3^{ijk}(k_\perp, k_{1\perp}) \otimes \langle P | F^{-i} W g_s F^{-j} W F^{-k} W | P \rangle \\ &+ \mathcal{H}_4^{ijkl}(k_\perp, k_{1\perp}, k'_{1\perp}) \otimes \langle P | F^{-i} W g_s F^{-j} W g_s F^{-k} W F^{-l} W | P \rangle \end{aligned}$$

## WW approximation at large $k_t$ : the BFKL limit

- At large transverse momentum transfer, **no multiple scattering from the gauge links**

TMD with staple gauge links

$$\int \frac{d^2 \mathbf{k}}{(2\pi)^2} e^{-i(\mathbf{k} \cdot \mathbf{x})} \int dx^+ \left\langle P \left| F^{i-}(x) [x^+, \pm\infty]_{\mathbf{x}} [\pm\infty, 0^+]_{\mathbf{0}} F^{j-}(0) [0^+, \pm\infty]_{\mathbf{0}} [\pm\infty, x^+]_{\mathbf{x}} \right| P \right\rangle$$

Large  $k_{\perp} \sim Q \Rightarrow$  small transverse distance  $x_{\perp}$

$$[x^+, \pm\infty]_{\mathbf{x}} [\pm\infty, y^+]_{\mathbf{0}} \sim [x^+, y^+]_{\mathbf{x} \sim \mathbf{0}}.$$

All TMD distributions shrink into the **unintegrated PDF**

$$\int \frac{d^2 \mathbf{k}}{(2\pi)^2} e^{-i(\mathbf{k} \cdot \mathbf{x})} \int dx^+ \left\langle P \left| F^{i-}(x) [x^+, 0^+]_{\mathbf{0}} F^{j-}(0) [0^+, x^+]_{\mathbf{0}} \right| P \right\rangle \Big|_{x^-=0}$$

and one recovers a **BFKL cross section**.

# BFKL distributions and genuine twist corrections

Unintegrated PDF = 2-Reggeon matrix element

$$\int d^2x e^{-i(k \cdot x)} \int dx^+ \left\langle P \left| F^{i-}(x) [x^+, 0^+]_0 F^{j-}(0) [0^+, x^+]_0 \right| P \right\rangle \Big|_{x^- = 0}$$

Integration by parts

$$\int dx^+ \int d^2x e^{-i(k \cdot x)} k^i k^j \left\langle P \left| [-\infty, x^+]_0 A^-(x) [x^+, +\infty]_0 [+ \infty, 0^+]_0 A^-(0) [0^+, -\infty]_0 \right| P \right\rangle$$

We recognize the so-called **nonsense polarizations** in axial gauge. We could define a **Reggeon operator**:

$$R(x) = \int dx^+ [-\infty, x^+]_0 A^-(x) [x^+, +\infty]_0$$

and rewrite the unintegrated PDF as

$$\int \frac{d^2k}{(2\pi)^2} e^{-i(k \cdot x)} \frac{k^i k^j}{k^2} k^2 \left\langle P \left| R(x) R^\dagger(0) \right| P \right\rangle$$

## BFKL distributions and genuine twist corrections

What is neglected in BFKL: 3- and 4-Reggeon matrix elements.

$$\langle P | RR | P \rangle, \quad \langle P | R(g_s R) R | P \rangle, \quad \langle P | R(g_s R)(g_s R) R | P \rangle$$

They are **not perturbatively suppressed**.

Suppression = **WW approximation** (unquantifiable)

# The dilute limit

## The dilute limit in terms of TMD distributions

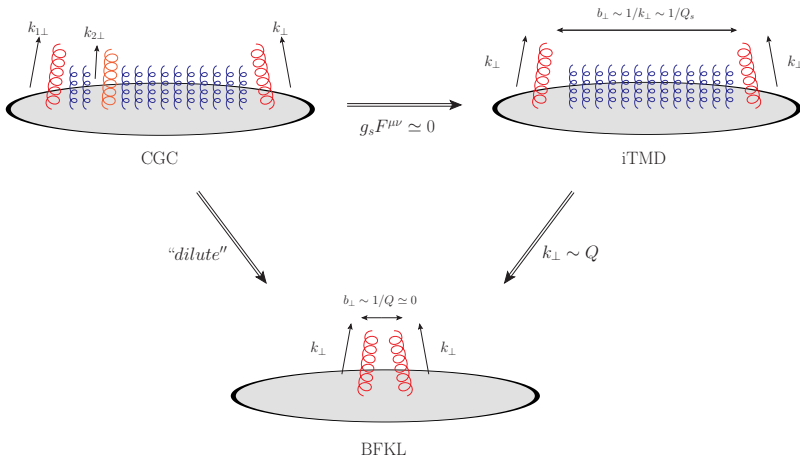

Two kinds of multiple scattering effects: **higher genuine twists** and **higher kinematic twists**

## Kinematic saturation

"Saturation" from a TMD gauge link

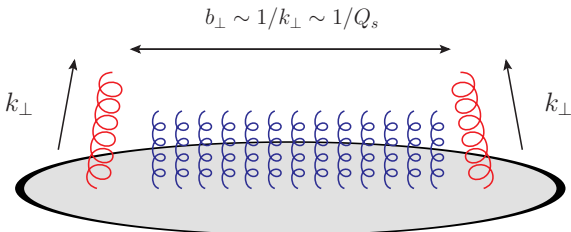

$$g_s^2 \int d^4 b \delta(b^-) e^{i(k \cdot b)} \langle P | F^{i-}(b) U_{b,0}^{[\pm]} F^{j-}(0) U_{0,b}^{[\pm]} | P \rangle$$

Expected at small  $k_{\perp}/Q$



## Kinematic saturation

## "Saturation" from a TMD gauge link

Link length  $\sim 1/|k_\perp|$ , hence effect **suppressed at large  $k_\perp$**

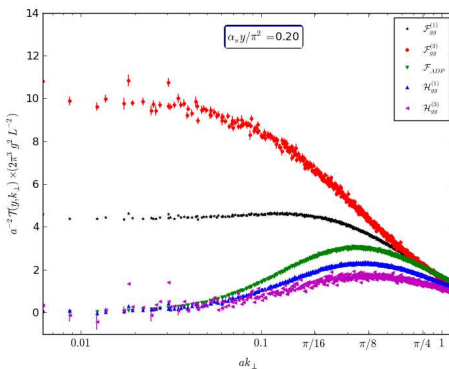

[Marquet, Petreska, Roiesnel ; Marquet, Roiesnel, Taels]

## Genuine saturation

”Saturation” as an **enhancement of genuine twists**

Large gluon occupancy  $\Rightarrow g_s F \sim 1$

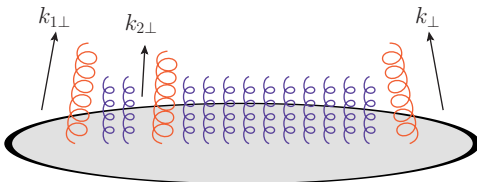

$$g_s^2 \int d^4 b_1 d^4 b_2 d^4 b' \delta(b_1^-) \delta(b_2^-) \delta(b'^-) e^{i(k_1 \cdot b_1) + i(k_2 \cdot b_2) - i(k \cdot b')}$$

$$\times \frac{\langle P | F^{i-}(b_1) \mathcal{U}_{b_1, b_2}^{[\pm]} g_s F^{j-}(b_2) \mathcal{U}_{b_2, b'}^{[\pm]} F^{k-}(b') \mathcal{U}_{b', b_1}^{[\pm]} | P \rangle}{\langle P | P \rangle}$$

$k_{\perp}/Q$ -suppressed: expected at large  $k_{\perp}$ ?

# Linearly polarized gluons at small $x$

## Polarized TMD in the CGC

Wilson line operators also contain **linearly polarized** gluon TMDs

$$\langle P | \partial^i U \partial^j U | P \rangle \rightarrow \frac{\delta^{ij}}{2} \mathcal{F}(k_\perp) + \left( \frac{k_\perp^i k_\perp^j}{k_\perp^2} - \frac{\delta^{ij}}{2} \right) \mathcal{H}(k_\perp)$$

- $\mathcal{F}$ : unpolarized TMD,  $\mathcal{H}$ : linearly polarized (Boer Mulders) TMD
- $\mathcal{H}$  can be observed in processes with **massive quarks** [Marquet, Roiesnel, Taels]
- Or in **processes with 3 body final states** (requires an extension of the notion of the correlation limit) [Altinoluk, RB, Marquet, Taels]
- Can also be seen from **loop corrections to 2-body observables**, for example **prompt photon+jet production in  $pA$  collisions** [Benić, Dumitru], based on a computation by [Benić, Fukushima, Garcia-Montero, Venugopalan]

## Polarized TMD in the CGC

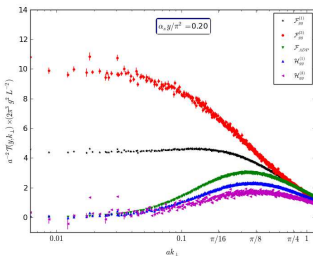

In the large  $k_\perp \sim Q$  limit (BFKL limit), all TMDs are equal:

$$\mathcal{F}(k_\perp) = \mathcal{H}(k_\perp), \text{ then } \langle P | \partial^i U \partial^j U | P \rangle \rightarrow \frac{k_\perp^i k_\perp^j}{k_\perp^2} \mathcal{F}(k_\perp)$$

We can recognize the so-called *non-sense polarization* in lightcone gauge:  $\frac{k_\perp^i}{|k_\perp|}$ .  
 BFKL contains as many linearly polarized gluon pairs as unpolarized ones.

At large  $k_\perp$ , gluon distributions are very polarized

## Conclusions

- **TMD distributions** are what allows to match standard parton distributions and **semi-classical descriptions of small  $x$  physics**
- Dipole and Color Glass Condensate models can give **insights on TMDs at small  $x$**
- The reformulation of shockwaves in terms of TMD distributions allows to understand **polarized gluon distributions at small  $x$**
- **Two distinct kinds of multiple scattering effects** must be distinguished to understand **gluonic saturation models**

# Backup

# Operator product expansion (OPE)

- **Moderate  $\times$  OPE:** factorization

$$\mathcal{O}(z) \rightarrow \sum_n C_n(z, \mu) \mathcal{O}_n(\mu)$$

- Operators are ordered in **twists** (dimension – spin)
  - Divergences in  $C_n$  are canceled via **renormalization** of  $\mathcal{O}_n$
  - **Easy task:** resumming **powers of  $s$**  and **logarithms of  $Q^2$** . **Difficulty:** including **twist corrections** and **logarithms of  $s$**
- **Low  $\times$  OPE:**

$$\mathcal{O}(z) \rightarrow C_0(z, Y) \mathcal{O}_0(Y) + \alpha_s C_1(z, Y) \mathcal{O}_1(Y) + \dots$$

- Operators are sorted by **representations of  $SU(N_c)$** , order by order in  $\alpha_s$
- Built order by order in  $\alpha_s$ . The **spurious pole** in  $C_n(z, Y)$  is canceled via the **B/JIMWLK RGE** of  $\mathcal{O}_{n-1}(Y)$
- **Easy task:** resumming **twists** and **logarithms of  $s$** . **Difficulty:** including **subeikonal corrections** and **logarithms of  $Q^2$**



## Small dipole "correlation" expansion

Taylor expansion of the Wilson line operators

$$U_{b+\frac{r}{2}}^{R_1} T^{R_0} U_{b-\frac{r}{2}}^{R_2} - U_b^{R_1} T^{R_0} U_b^{R_2} = \frac{r^i}{2} \left[ \left( \partial^i U_b^{R_1} \right) T^{R_0} U_b^{R_2} - U_b^{R_1} T^{R_0} \left( \partial^i U_b^{R_2} \right) \right] + \mathcal{O}(r^2)$$

allows for a match at **leading twist**

$$\begin{aligned} d\sigma &= \mathcal{H}(b, r) \otimes \left[ U_{b+\frac{r}{2}}^{R_1} T^{R_0} U_{b-\frac{r}{2}}^{R_2} - U_b^{R_1} T^{R_0} U_b^{R_2} \right] \\ &\times \mathcal{H}^*(b', r') \otimes \left[ U_{b'-\frac{r'}{2}}^{R_2\dagger} T^{R_0\dagger} U_{b'+\frac{r'}{2}}^{R_1\dagger} - U_{b'}^{R_2\dagger} T^{R_0\dagger} U_{b'}^{R_1\dagger} \right] \end{aligned}$$

$$\rightarrow d\sigma_{k=0}^{(i)} \otimes \Phi^{(i)}(x, k) + \mathcal{O}(r^2)$$

How to extend this to higher twist corrections?

## Power expansion for TMD observables: dealing with powers of $k_{\perp}/Q$

Consider (hypothetical) hard subamplitudes with non-zero transverse momenta in the  $t$  channel. The amplitude would read:

$$\begin{aligned}
 & \mathcal{H}_1^i(\mathbf{k}) \otimes \int d^2\mathbf{x}_1 e^{-i(\mathbf{k}\cdot\mathbf{x}_1)} [\pm\infty, \mathbf{x}_1] F^{i-}(\mathbf{x}_1) [\mathbf{x}_1, \pm\infty] \\
 + & \mathcal{H}_2^{ij}(\mathbf{k}_1, \mathbf{k}_2) \otimes \int d^2\mathbf{x}_1 d^2\mathbf{x}_2 e^{-i(\mathbf{k}_1\cdot\mathbf{x}_1)-i(\mathbf{k}_2\cdot\mathbf{x}_2)} [\pm\infty, \mathbf{x}_1] F^{i-}(\mathbf{x}_1) [\mathbf{x}_1, \mathbf{x}_2] F^{j-}(\mathbf{x}_2) [\mathbf{x}_2, \pm\infty] \\
 + & \dots \\
 = & \mathcal{H}_1^i(\mathbf{k}) \otimes \mathcal{O}_1^i(\mathbf{k}) + \mathcal{H}_2^{ij}(\mathbf{k}_1, \mathbf{k}_2) \otimes \mathcal{O}_2^{ij}(\mathbf{k}_1, \mathbf{k}_2) + \dots
 \end{aligned}$$

Power expansion for TMD amplitudes:  
dealing with powers of  $k_{\perp}/Q$

Leading twist amplitude

$$\mathcal{A}_{LT} = \mathcal{H}_1^i(\mathbf{0}) \otimes \mathcal{O}_1^i(\mathbf{k})$$

Next-to-leading twist amplitude

$$\mathcal{A}_{NLT} = \mathbf{k} \cdot (\partial_{\mathbf{k}} \mathcal{H}_1^i)(\mathbf{0}) \otimes \mathcal{O}_1^i(\mathbf{k}) + \mathcal{H}_2^{ij}(\mathbf{0}, \mathbf{0}) \otimes \mathcal{O}_2^{ij}(\mathbf{k}_1, \mathbf{k}_2)$$

First term: kinematic twist correction, second term: genuine twist corrections

## Match without an expansion

Trick: rewrite operators in terms of their derivatives

$$U_{b+\bar{z}r}^{R_1} - U_b^{R_1} = -ir_{\perp}^{\mu} \int \frac{d^2 \mathbf{k}_1}{(2\pi)^2} \int d^2 \mathbf{b}_1 e^{-ik_1 \cdot (b_1 - b)} \frac{e^{i\bar{z}(k_1 \cdot r)} - 1}{(k_1 \cdot r)} \left( \partial_{\mu} U_b^{R_1} \right)$$

Rewrite the amplitude

$$\mathcal{A} = (2\pi) \delta(p_1^+ + p_2^+ - p_0^+) \int d^2 \mathbf{b} d^2 \mathbf{r} e^{-i(\mathbf{q} \cdot \mathbf{r}) - i(\mathbf{k} \cdot \mathbf{b})} \mathcal{H}(\mathbf{r})$$

$$\times \left[ \left( U_{b+\bar{z}r}^{R_1} - U_b^{R_1} \right) T^{R_0} \left( U_{b-zr}^{R_2} - U_b^{R_2} \right) + \left( U_{b+\bar{z}r}^{R_1} - U_b^{R_1} \right) T^{R_0} U_b^{R_2} + U_b^{R_1} T^{R_0} \left( U_{b-zr}^{R_2} - U_b^{R_2} \right) \right]$$

genuine twist

kinematic + genuine twists

Extracting genuine twists: Taylor, IbP, resummation.

Saturation effects: Shockwaves vs iTMD vs BFKL

