



Status of the Archimedes Experiment

- INFN_sezione di Naples – Laboratorio Fisica della Gravitazione Univ. Federico II
- INFN sezione di Roma1 – Univ. La Sapienza Roma
- INO sezione di Napoli
- Université de Aix-Marseille Centre de Physique Théorique de Luminy Institut Universitaire de France
- EGO European Gravitational Observatory - Italy

Scientific Motivations



Since the birth of Quantum Mechanics the question rised if the zero-point energy gravitates (Nerst, Pauli...) –The first attempt of by Pauli



$$\sum \frac{1}{2} \hbar \omega \quad \longrightarrow \quad \infty$$

Pauli inserted a cut-off on the minimal length (electron classical radius) and inserted the value of the energy density in the static Einstein solution

The expected radius of the Universe was: 31 Km!

Cosmological constant problem: “why the universe exhibits a vacuum energy density much smaller than the one resulting from application of quantum mechanics and equivalence principle?” (Weinberg **Rev.Mod.Phys. 61 (1989) 1-23**)

Main question still open with no experimental answer

Does vacuum fluctuations gravitate or not?

Does vacuum pressure exhibits the red-shift ?

The reality of macroscopic vacuum fluctuation.

The Casimir effect It is derived considering the zero point e.m. energy contained in a Casimir cavity, i.e. in the volume defined by two perfectly reflecting parallel plates

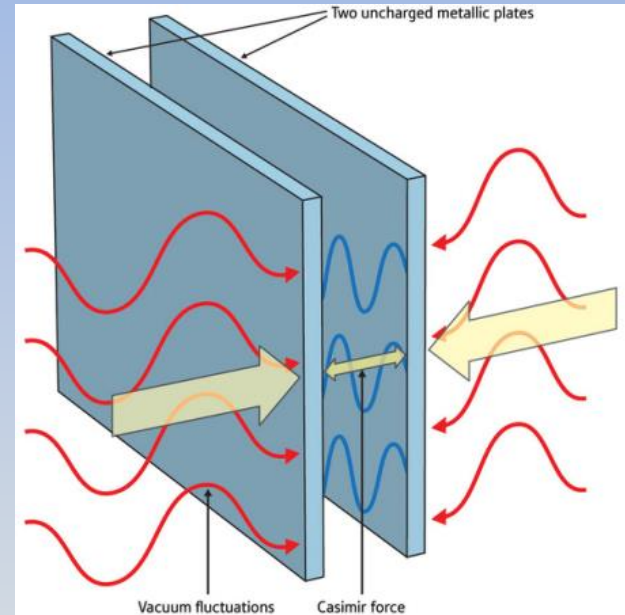

$$E = \sum \frac{1}{2} \hbar \omega$$

If the plates are perfectly reflecting the modes that can oscillate must have discrete wavenumbers on vertical axes $k_z = n\pi/a$ while all values are allowed for k_x e k_y

$$E = \frac{hcL^2}{2} \sum_{n=-\infty}^{n=\infty} \int \frac{d^2k}{(2\pi)^2} \sqrt{k^2 + \left(\frac{n\pi}{a}\right)^2} \longrightarrow \infty$$

The regularization is made by determining the Casimir Energy as the change in energy when the plates are at distance “a” with respect to the plates having $a \rightarrow \infty$

$$E_{\text{reg}} = E(a) - E(\infty)$$

- **Casimir Energy** $E_{\text{reg}} = -\frac{\pi^2 L^2 hc}{720a^3}$

- **Casimir Pressure** $P_c = \frac{1}{L^2} \frac{\partial U}{\partial a} = -\frac{\pi^2 hc}{240a^4} = 1.3 \times 10^{-3} \text{ N/m}^2 (1 \mu\text{m}/a^4)$

First prediction: Casimir 1948

First measure (force): Sparnay 1956

First measure (force) in the original flat-flat configuration: Carugno: 2002

Presently tested (force) with an accuracy of 0.5% (Mohideen: 2005)

(No problems in QFT in flat space-time)

Weighing the vacuum

The idea is to weigh a **rigid** Casimir cavity when the vacuum energy is modulated by changing the reflectivity of the plates. The forces along z are

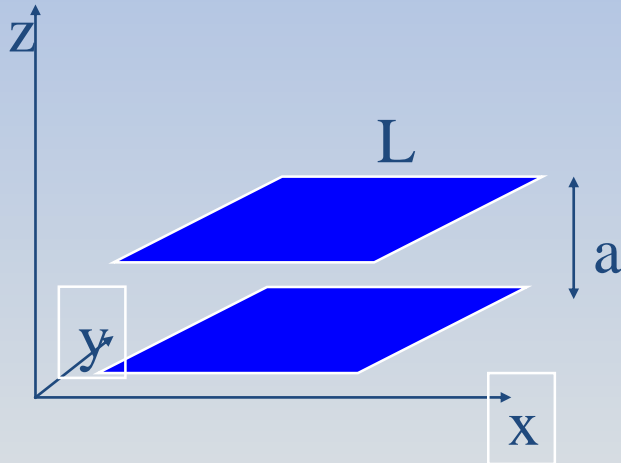

$$\left\{ \begin{array}{l} F_{\text{sup}} = -F_C \\ F_{\text{inf}} = F_C (1 + \delta\phi) + \frac{|E_C|}{c^2} g \end{array} \right.$$

$$\delta\phi = \frac{g \cdot a}{c^2} \longleftrightarrow \text{difference of gravitational potential between the plates}$$

$$\vec{F}_{\text{tot}} = \frac{|E_C|}{c^2} g \hat{z}$$

The total force is directed upward and it is equal to the weight of the vacuum modes that are removed from the cavity

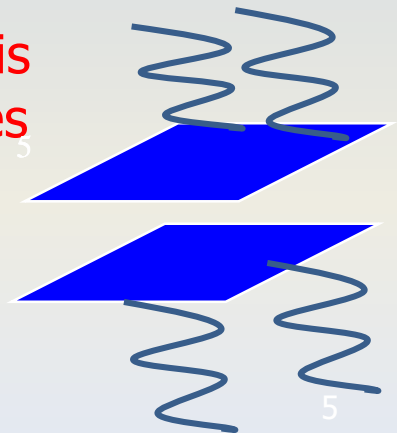

IN ANALOGY WITH ARCHIMEDES FORCE

Pressure red-shift

A simple summation of the lower force and upper force on the plates would bring to a somewhat unsuspected result:

$$F_{\text{inf}} + F_{\text{sup}} = F_{\text{cas}} (1 + \delta\phi) + \frac{|E_C|}{c^2} g - F_{\text{cas}} = 4 \frac{|E_C|}{c^2} g$$

$$F_{\text{cas}} = -L^2 \frac{\pi \hbar c}{240 a^4}$$

$$E_{\text{cas}} = -L^2 \frac{\pi \hbar c}{720 a^3}$$

The lower vacuum «photons» must exert a bigger force because the force will be red-shifted when reaching the same level of upper plate → in the experiment the sum must be done taking into account the red-shift because the cavity is rigid and hanged in a unique point - **(for this effect our measurement is a null measurement on pressure red-shift)**

$$\left\{ \begin{array}{l} F_{\text{sup}} = F_C \\ F_{\text{inf}} = -F_C (1 + \delta\phi) + \frac{|E_C|}{c^2} g \end{array} \right. \longleftrightarrow \vec{F}_{\text{tot}} = \frac{|E_C|}{c^2} g \hat{z}$$

E. Calloni et.al. Phys. Letters A, 297, 328-333, (2002)

G. Bimonte, E. Calloni, G. Esposito, L. Rosa - Phys. Rev D 74, 085011 (2006)

G. Bimonte, E. Calloni et. al. Phys.Rev.D76:025008, (2007)

G. Bimonte, E. Calloni, L. Rosa, Phys.Rev.D77:044026, (2008)

5

On interpretation of Tolman-Ehrenfest effect:

C. Rovelli, M. Smerlak Class. Quant. Grav. 28 (2011) 075007

6

Proposal : weighing the condensation energy of Type II superconductors and modulate the transition to modulate the weight

- 1) Use high_ T_c layered superconductors as natural multi Casimir-cavities
- 2) Profit of the fact that in normal state the plane (that will become superconducting) is a very poor conductor \rightarrow good variation of Casimir energy at the transition



The variation of casimir energy can be a significant fraction of the whole energy condensation

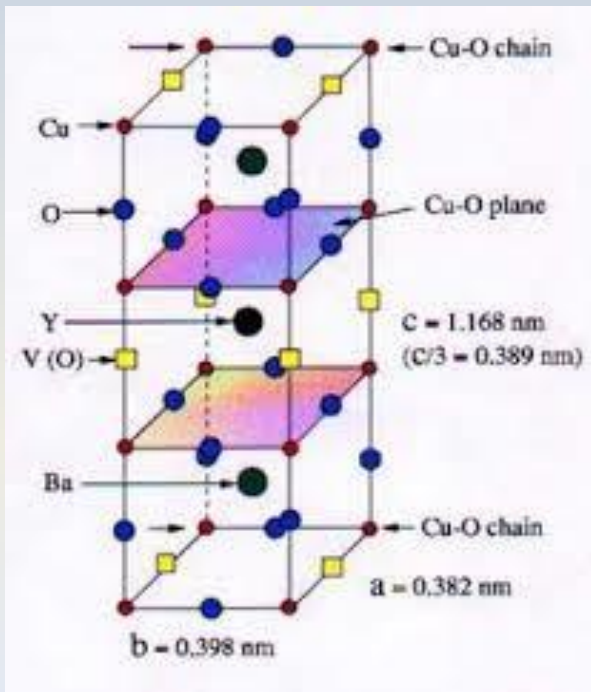

The planes have high transmittivity also in superconducting state so the expected modulation with respect to the ideal case of totally reflective plane is a small fraction – But even this small fraction would correspond to a significant fraction of the whole condensation energy

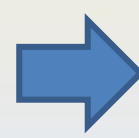

$$\Delta \eta_E = \frac{\Delta E_C}{E_C} \approx 10^{-4}$$

Proposed measurement

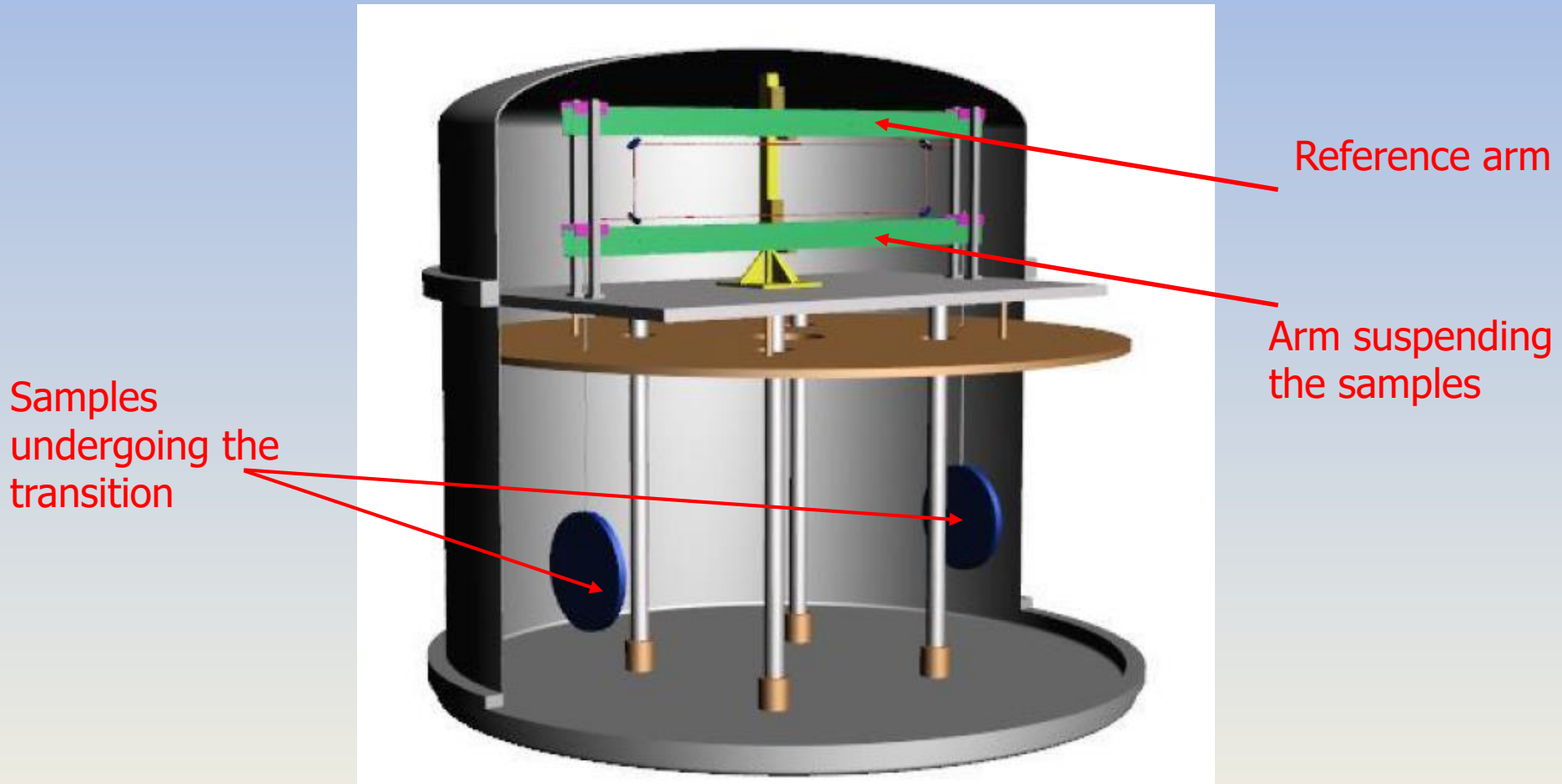

Use a beam-balance → modulate the force by modulating the temperature of the superconductor so that it makes transitions between Normal and superconducting state - Expected modulation of force $F = 4 \cdot 10^{-16}$ N

Three main lines to be addressed toward final measurement

- ❑ Better theoretical evaluation of the contribution of Casimir Energy to transition energy
- ❑ Realization of a balance extremely sensitive
- ❑ Find a quiet site!

Progress on Casimir contribution to transition energy

Starting point: Kempf hypothesis: plasma sheet no dissipation
– zero temperature - order of magnitude estimation

Coupled cavities and low thickness limit regime with descriptions of each layer as a very thin superconductor which undergoes conductivity variation at the transition

Coupled cavities and plasma sheet description of each layer with dissipation and actual temperature

$$\Delta\eta_E \approx 10^{-4}$$

R. Bimonte, E. Calloni et al -Towards measuring variations of Casimir energy by a superconducting cavity
Phys.Rev.Lett. 94 (2005) 180402

L. Rosa et al - Casimir energy for two and three superconducting coupled cavities: Numerical calculations
Eur.Phys.J.Plus 132 (2017) no.11, 478

L. Rosa et al – Casimir energy for layered superconductors (in preparation -2018)

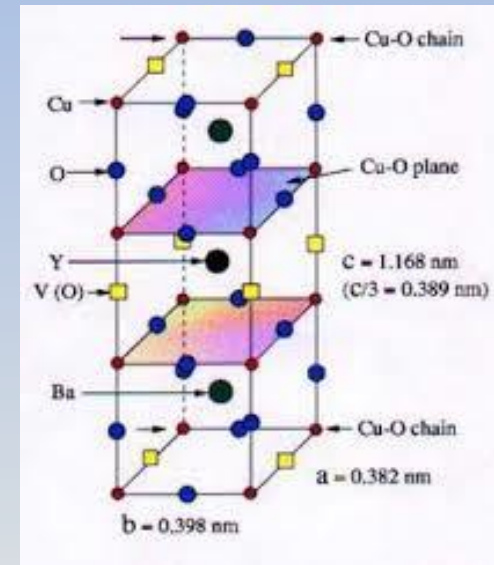

Large diameter superconductor discs

- Large YBCO discs are produced (CAN Superconductors)
- Tests on custom samples with diameter 10 cm, thickness 3 mm
- Sufficient uniformity
- Transition width too large
- New samples with different production techniques have been provided – under tests in Rome – with smaller diameter 4 cm

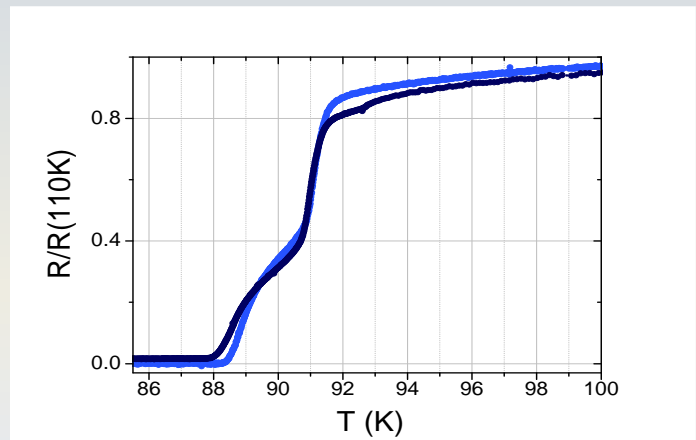
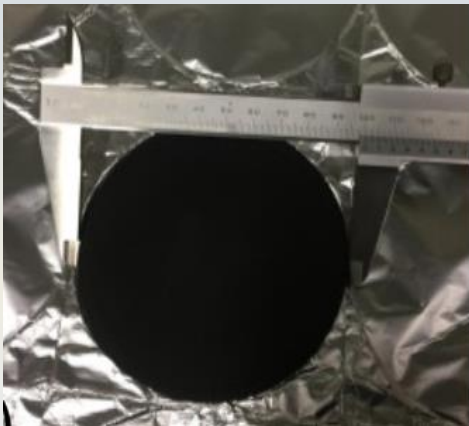

The Balance prototype

- ❑ Design similar to LIGO¹ tilt-meter but with much work on joints design to maintain low resonance frequency with low moment of inertia
- ❑ Present Read-out: combination of optical lever and interferometer
- ❑ Freed-back with electrostatic actuators to have a very long term stability

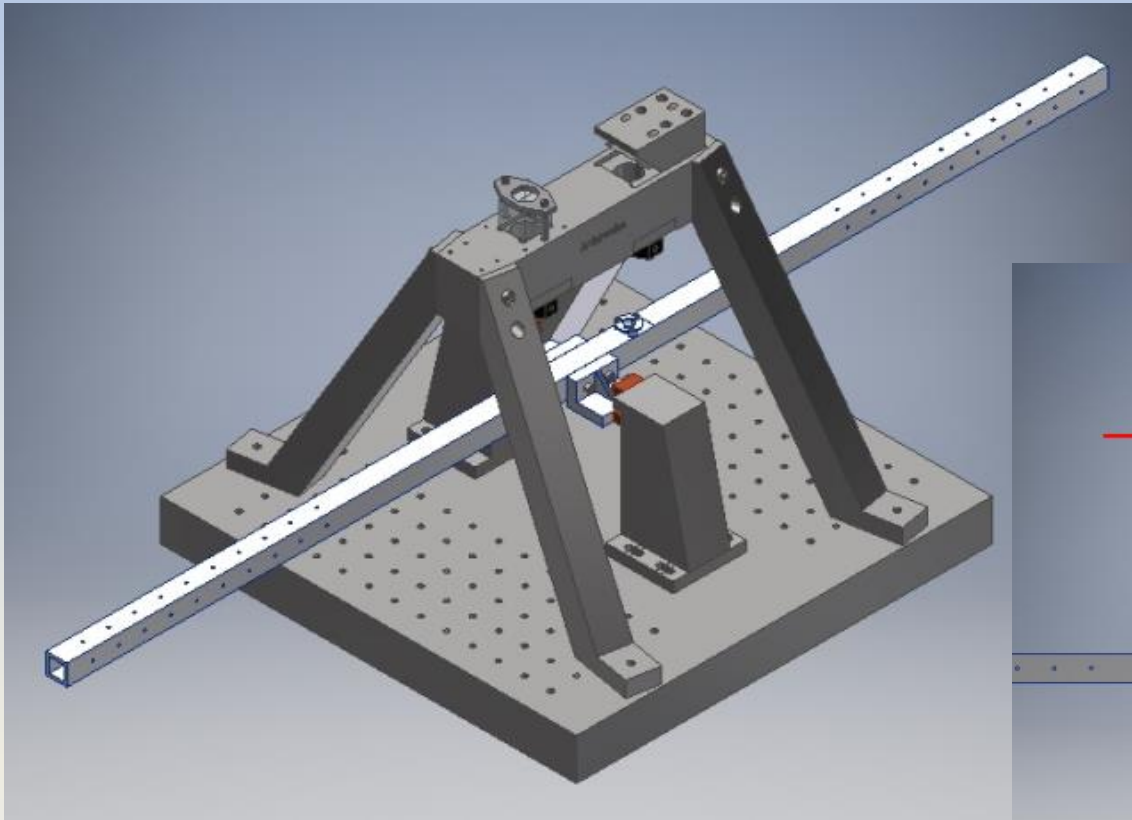

Scheme of the balance

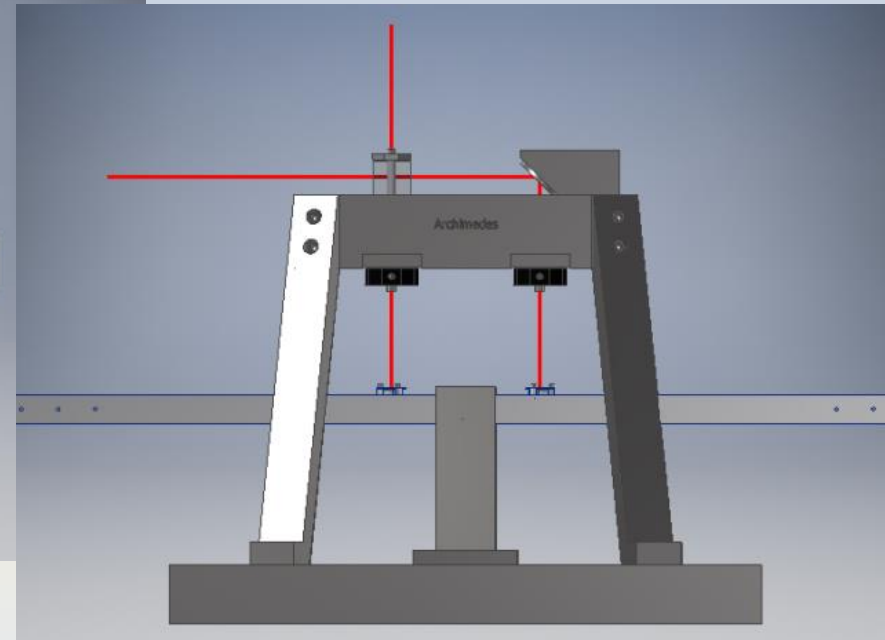

Scheme of interferometric sensing: the lens allows very good alignment even for high tilts

Optical lever for initial locking

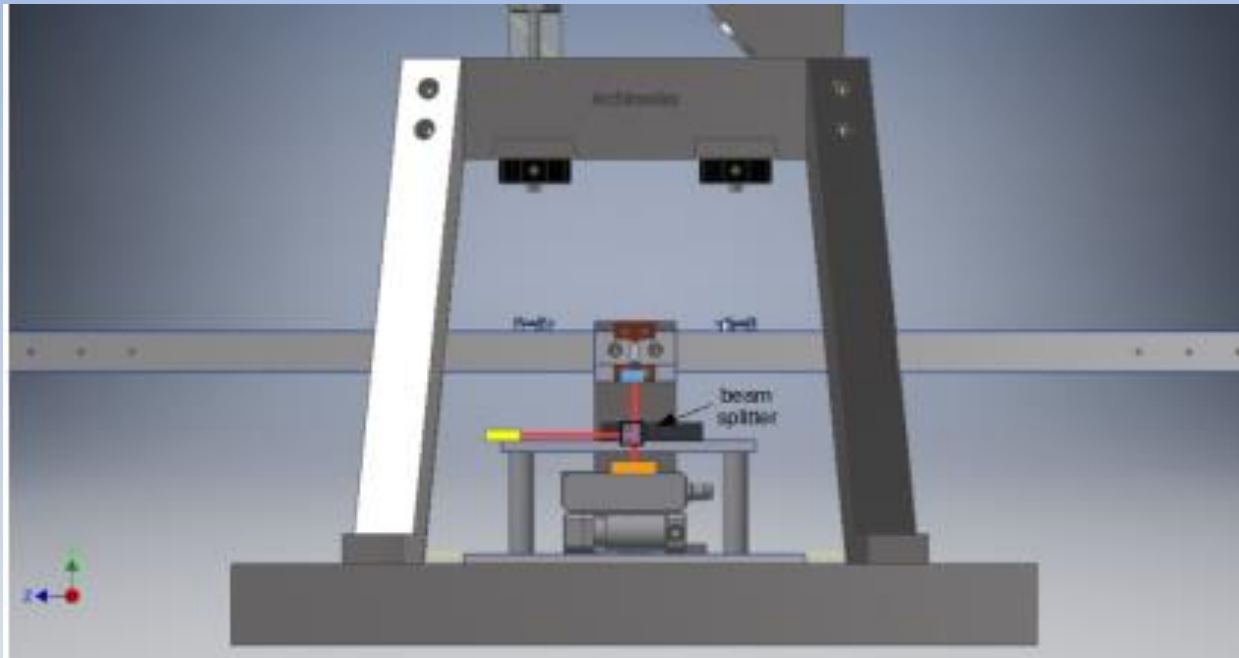

Balance with of the optical lever

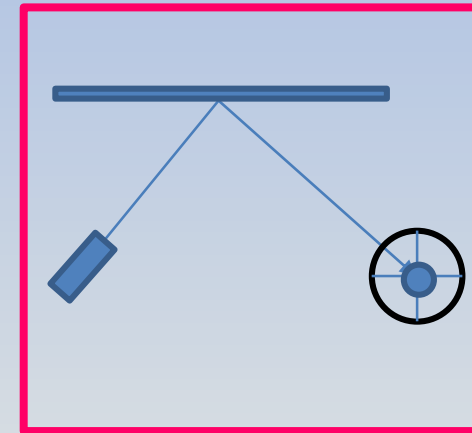

Scheme of optical lever

The balance is brought to the working point with an auxiliary-compact design optical lever. Electrostatic actuators.

The photodiode is motorized to let work the balance in closed loop but around its equilibrium point, to minimize the DC current

Photon Calibration

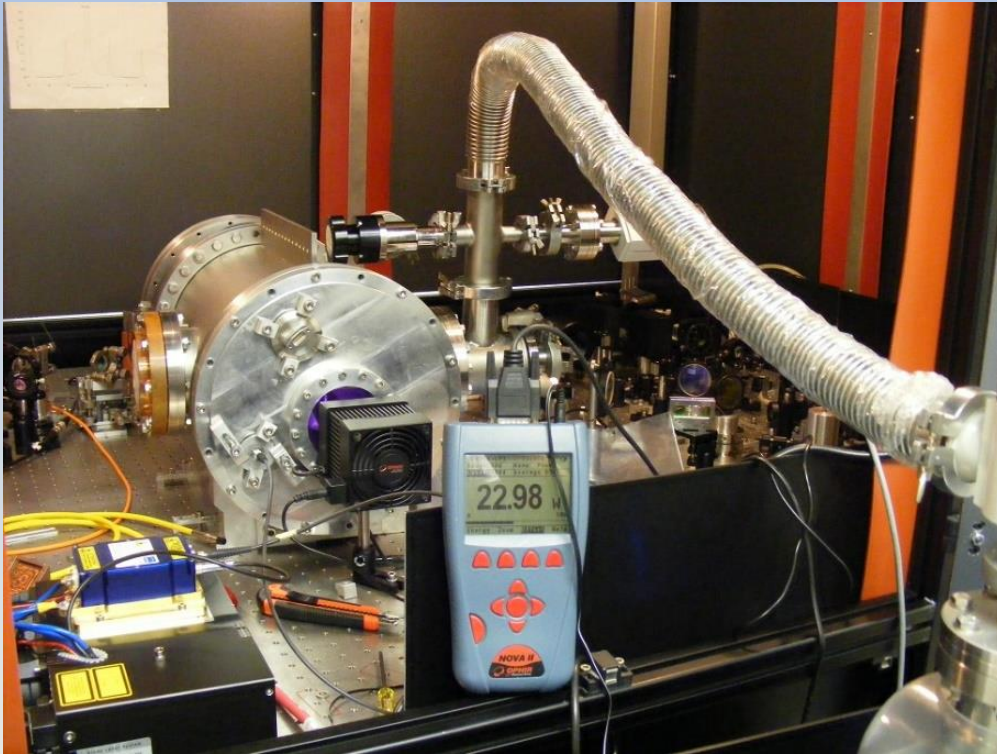

EGO realized and tested an homemade optical feedthrough

23 W optical power in vacuum is more than satisfactory for our purposes

Virgo-like diode laser

Actual balance

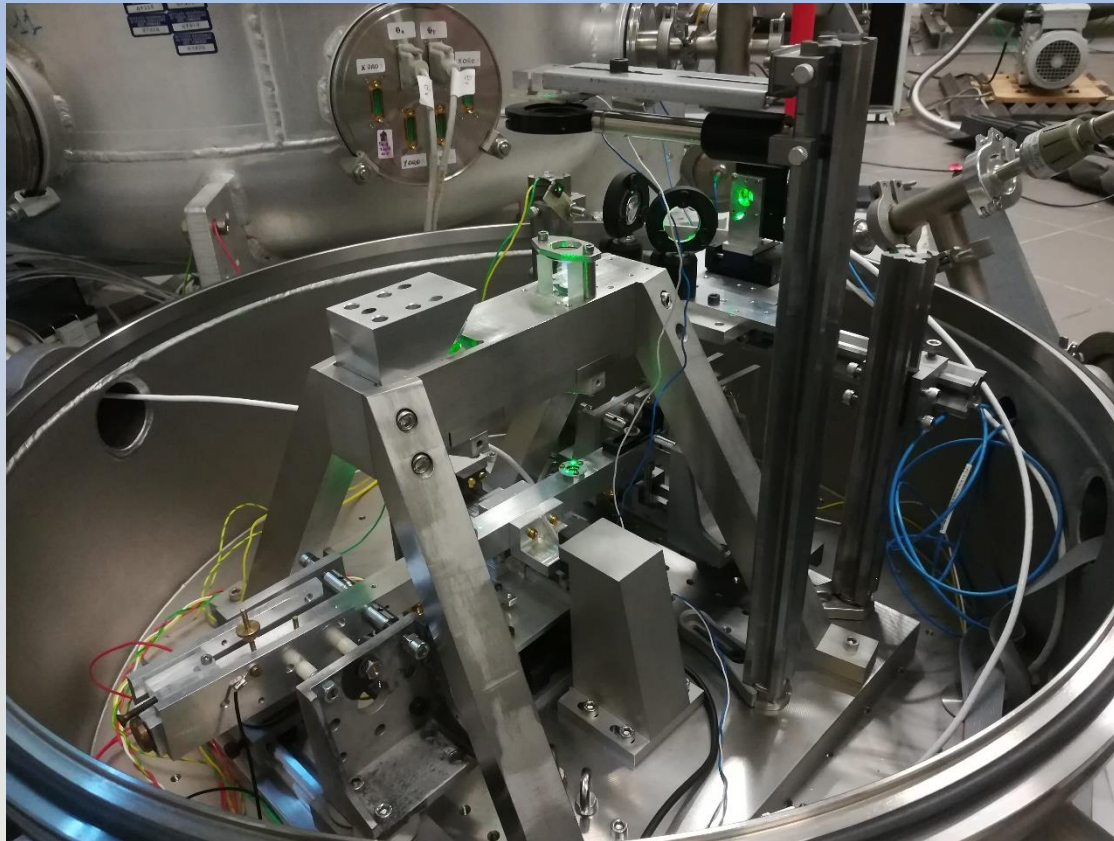

*Picture of the present balance.
Several parts tested and verified for the final balance*

Torque Sensitivity

Long Optical lever configuration

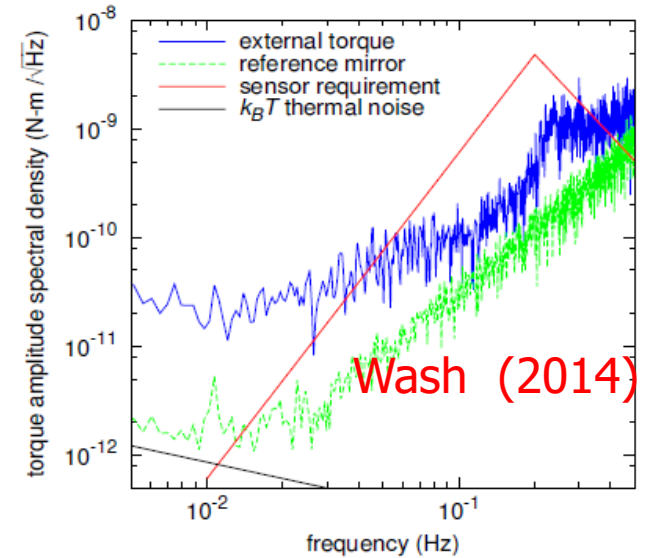
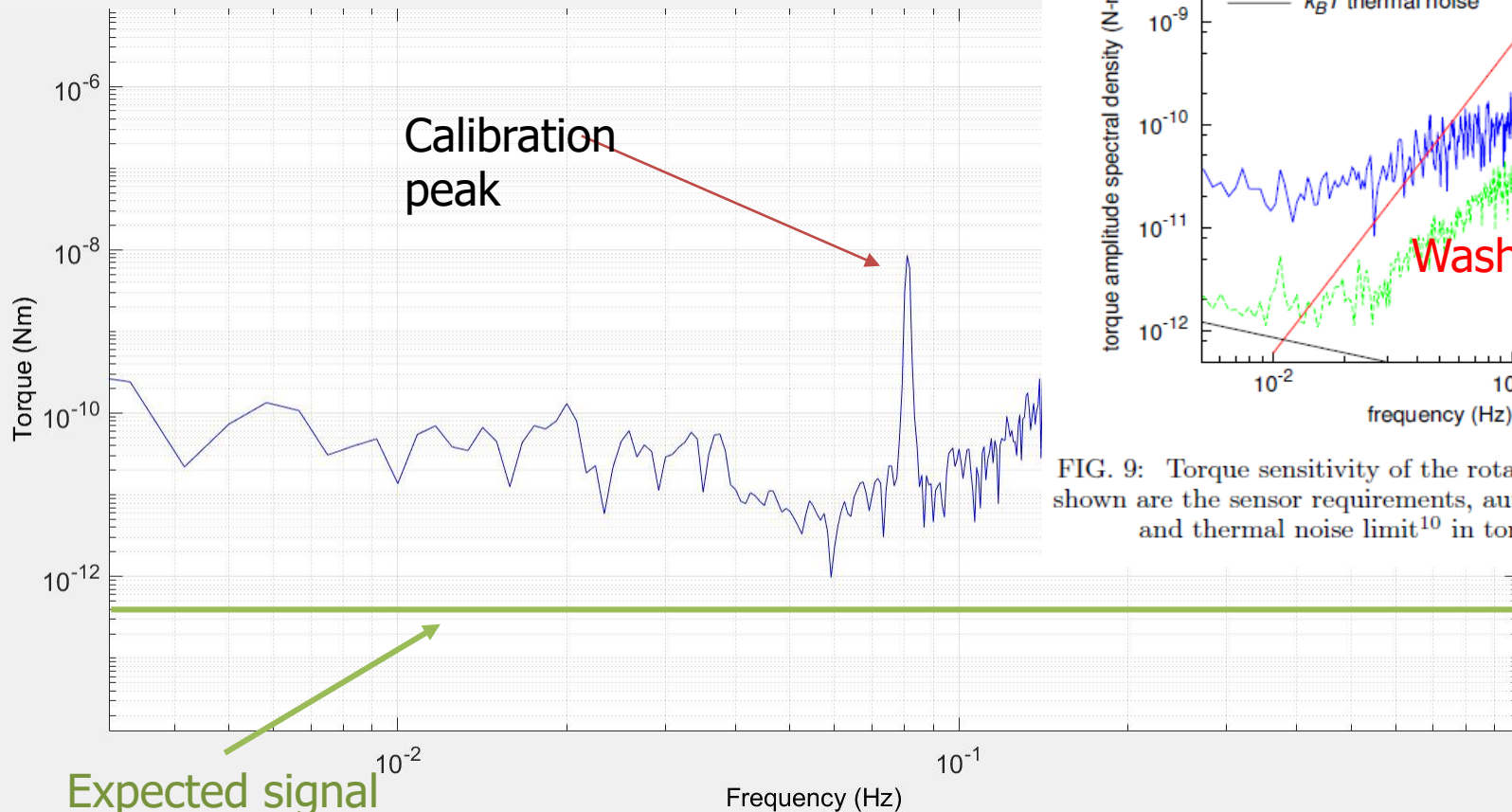

FIG. 9: Torque sensitivity of the rotation sensor. Also shown are the sensor requirements, autocollimator limit and thermal noise limit¹⁰ in torque units.

Expected signal

- No showstopper in lowering the moment of inertia
- Good sensitivity
- Long term stability

Test of Interferometric read-out

- Naples laboratory floor is particularly noisy at high frequency.
- The interferometer signal up-convert the noise up to tens of Hz – Not possible to close the loop
- Temporary solution: loop closed on the (short) optical lever and use the ITF as out of loop sensors to subtract the optical lever sensing noise

Y signal read by the optical lever
ITF interferometer signal
V_{corr} correction voltage

H is the plant,
I interferometer sensitivity
OL is the sensitivity of the lever
G is the control filter
 α is the constant amplifiers and actuators (Nm / Volt).

τ_n is the moment on the scale, ITF_n noise interferometer
S_n noise optical lever.

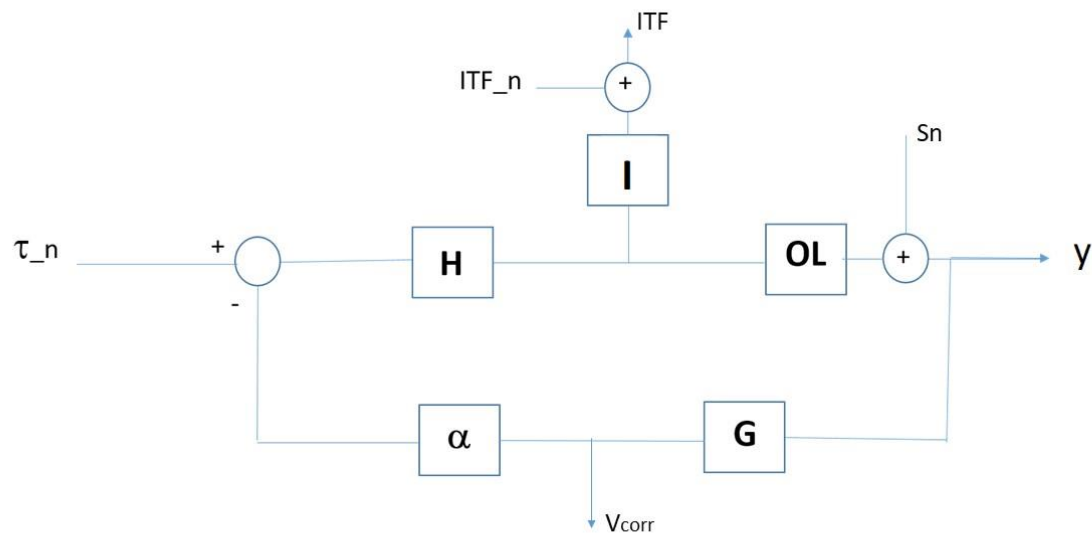

Scheme of the loop

Torque sensitivity

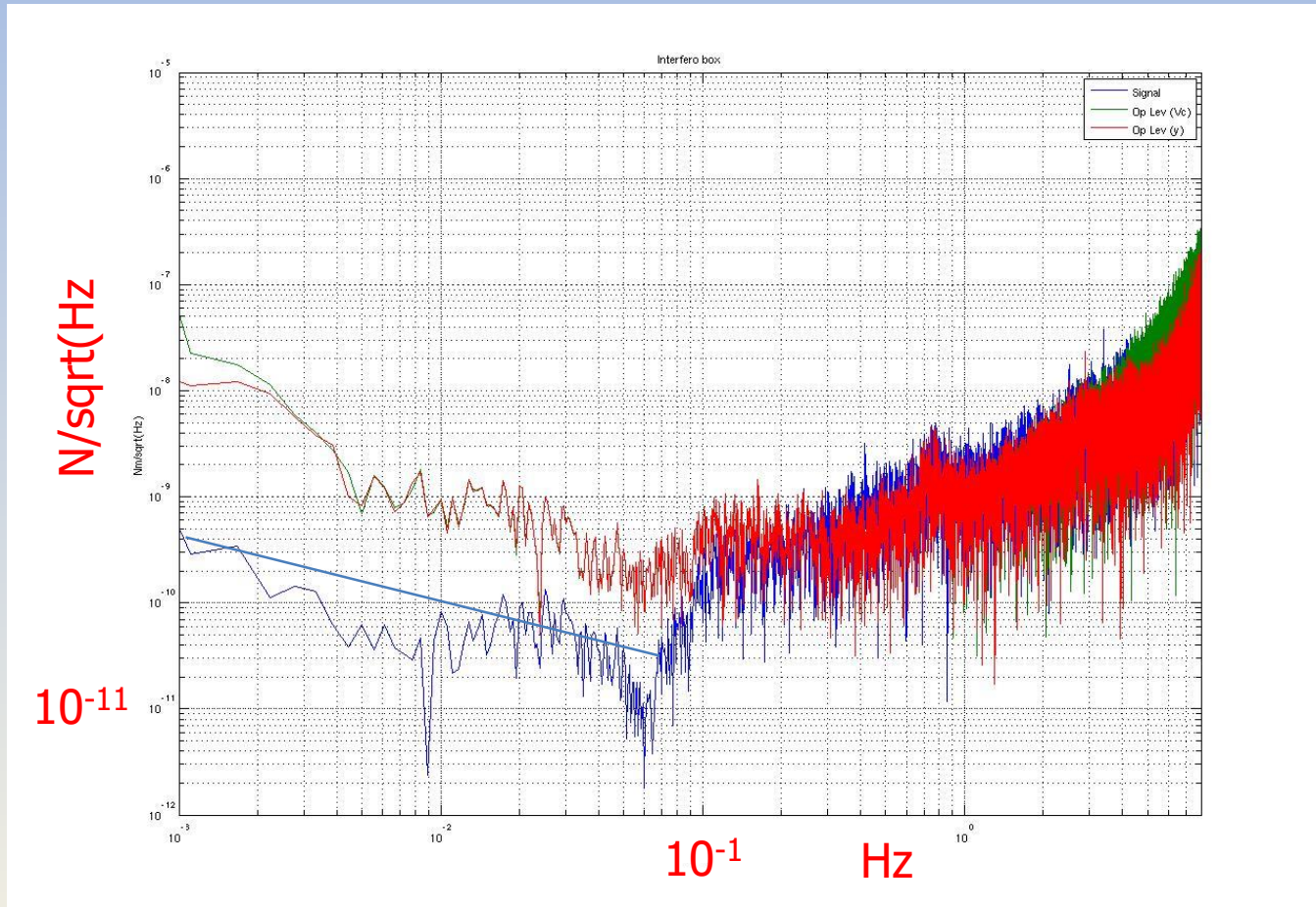

Preliminary results: sensitivity comparable with the long-optical lever

Short Term activity on the balance

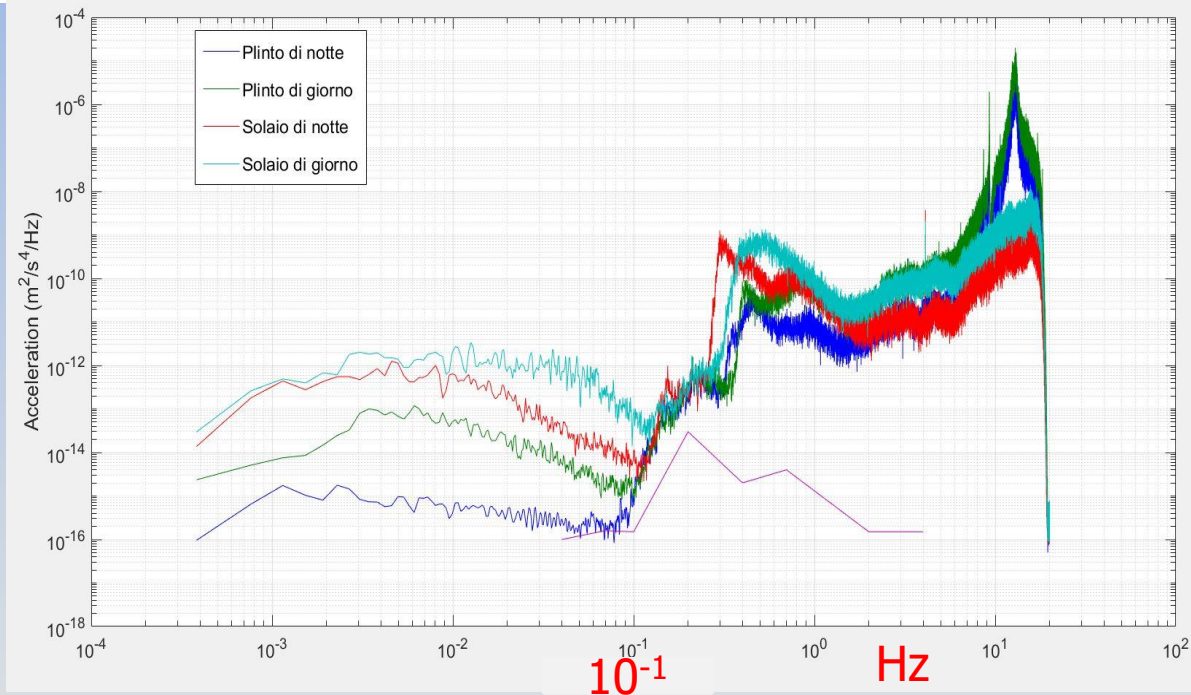

Step 1) Isolate the balance to reduce at least the higher frequency noise and complete the tests on interferometer (thanks to PV-LAS collaboration for renting the isolator)



Step 2) Move as soon as possible in a quieter site

Cryogenic system

- ❑ Temperature of the samples $T = 90$ K (modulated by $\Delta T > 0.5$ K)
- ❑ The balance is inside the cryostat
- ❑ Inner vacuum chamber diameter: 1.60 m – cryostat height: 3.2 m

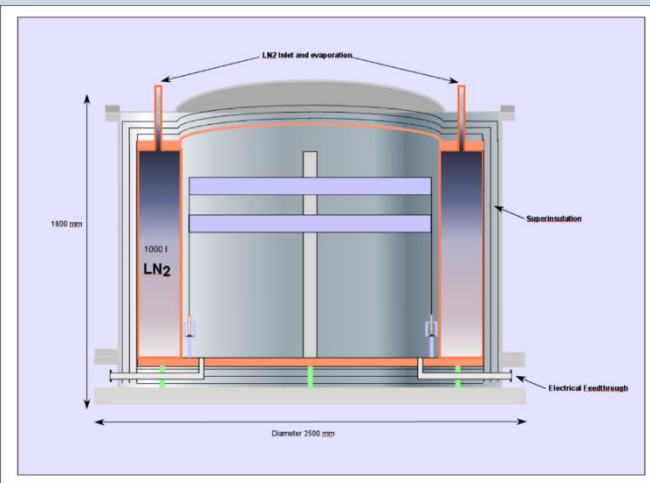

Preliminary design of the Cryostat

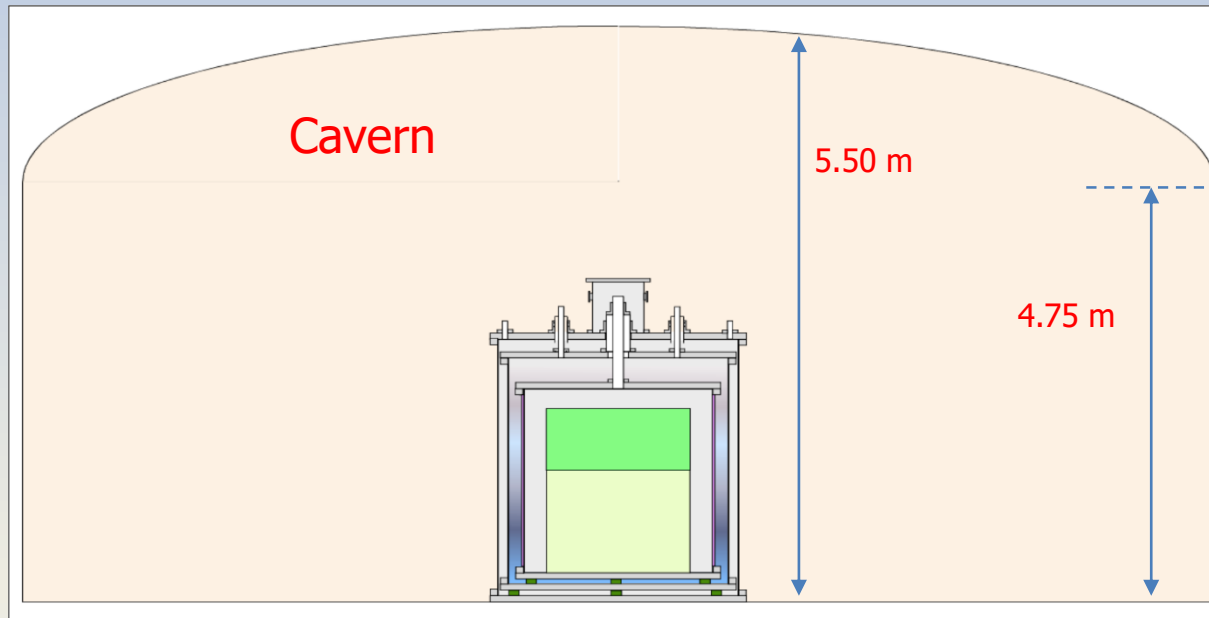

Cryostat inside the cavern. In green the balance required volume, in yellow the space for samples and thermal actuators.

The cryostat

- ❑ Design of the cryostat ended.
- ❑ Construction started

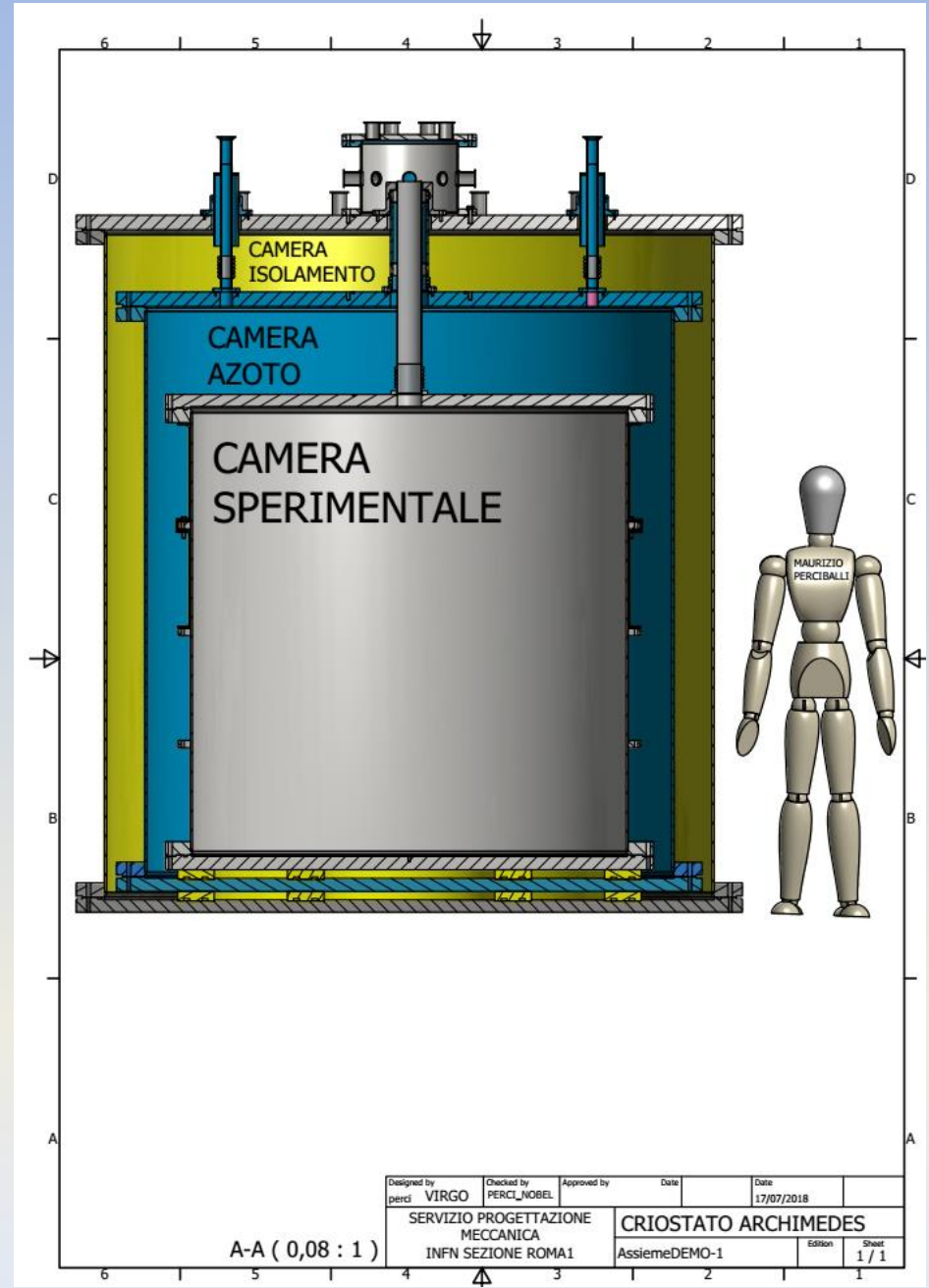

Temperature modulation

Temperature modulation is obtained by exposing the sample to a surrounding environment whose temperature is modulated

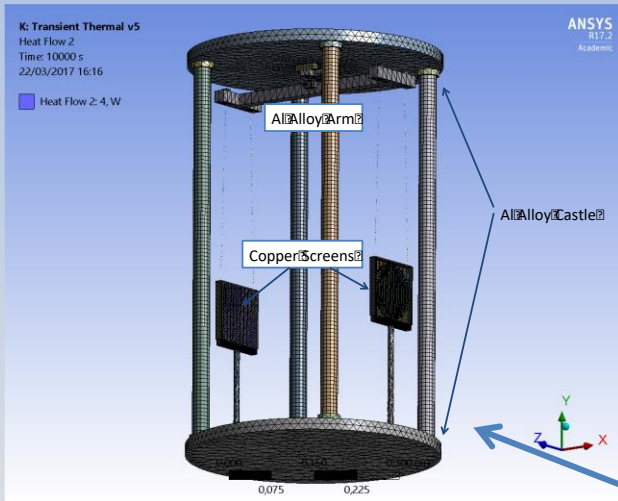

Criostato Virgo lab

2' diam, 5 mm thick
substrate for YBCO

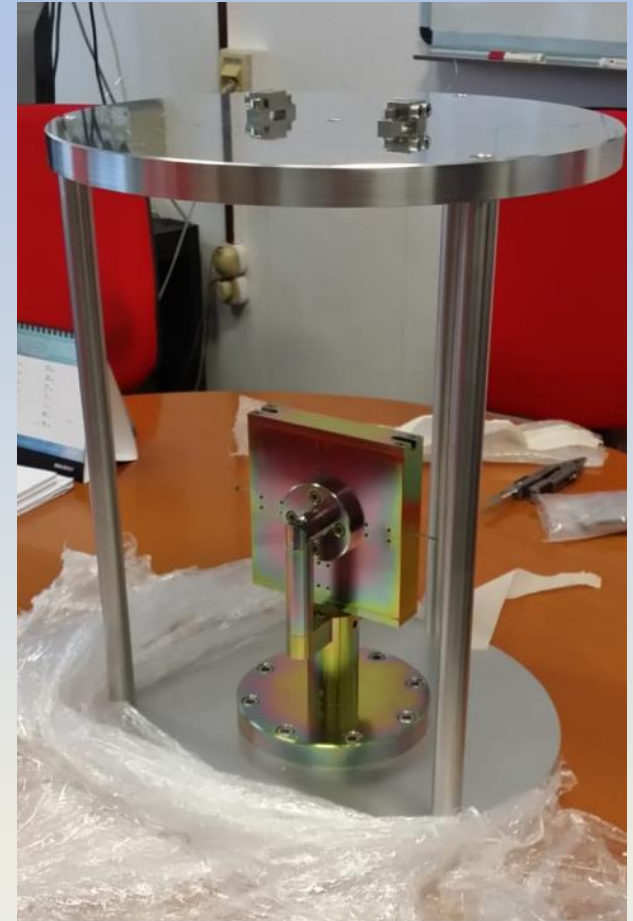

Case with only radiative heat exchange

FEM simulation

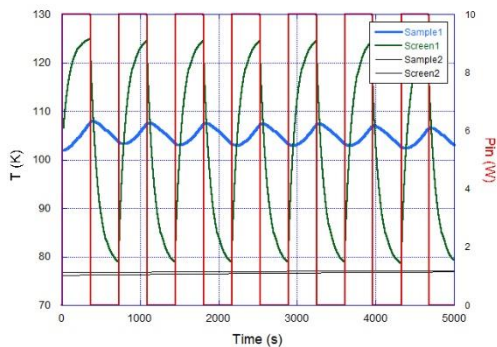

Under test 1mm thick YBCO samples

A quiet site!

Low seismic – No antropic noise

Sindaco	Mario Calia (lista civica) dall'11-6-2012
Territorio	
Coordinate	40°28'N 9°29'E
Altitudine	521 m s.l.m.
Superficie	148,72 km ²
Abitanti	1 407 ^[1] (31-7-2016)
Densità	9,46 ab./km ²
Comuni confinanti	Bitti, Dorgali, Galtelli, Irgoli, Loculi, Lodè, Onani, Orune, Siniscola



SOS-Enattos Mine

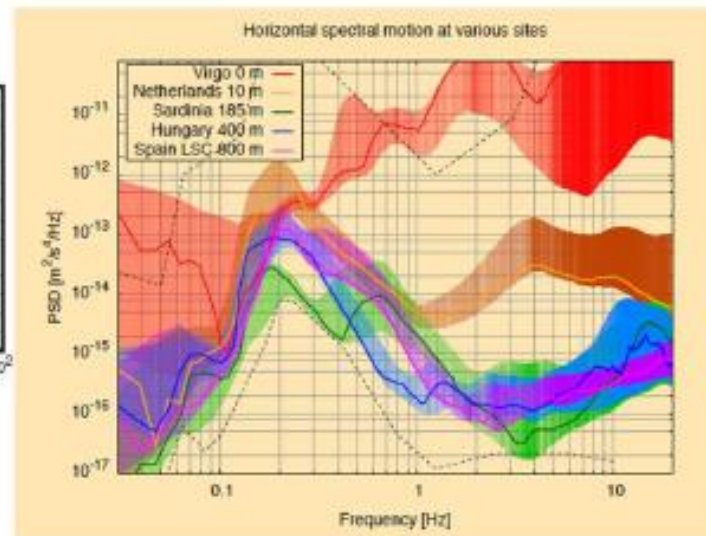
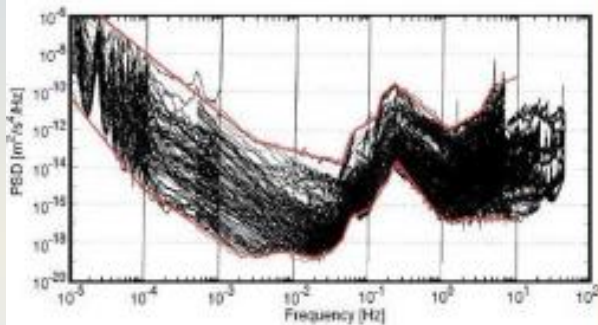

Seismic
 Measurements
 By Virgo and
 ET collaborations

SAR-GRAV

- **Summer 2018: constitution of SAR-GRAV Consortium**

Oggetto sociale del Consorzio è sviluppare attività scientifiche e tecnologiche orientate alla ricerca di base nell'ambito della rilevazione delle **Onde Gravitazionali, della Fisica della Gravitazione, della Geofisica e delle sue applicazioni**, e di proporre soluzioni tecnologiche al mercato. Le attività del consorzio saranno principalmente realizzate attraverso la gestione ed utilizzo dell'infrastruttura di ricerca realizzata presso il sito minerario di Sos Enattos a Lula (NU) con il progetto "SAR-GRAV", finanziato dalla Regione Autonoma della Sardegna con Deliberazione n. 27/17 del 6 giugno 2017 e di cui all'accordo di programma del 5 febbraio 2018 sottoscritto fra **Regione Autonoma della Sardegna** - Assessorato Della Programmazione, Bilancio, Credito e Assetto del Territorio, l'Assessorato dell'Industria, **l'Università degli Studi di Sassari**, in qualità di soggetto proponente e capofila, **l'Istituto Nazionale di Fisica Nucleare (INFN)** e **L'Istituto Nazionale di Geofisica e Vulcanologia (INGV)** e per adesione **IGEA s.p.a**;

- Underground SAR-GRAV laboratory under construction
- Workshop «Vacuum Fluctuations at nanoscale and Gravitation: Theory and Experiments» **April 28th - May 3rd Orosei (NU)**
- First project to be hosted: Archimedes

SAR-GRAV TIMELINE

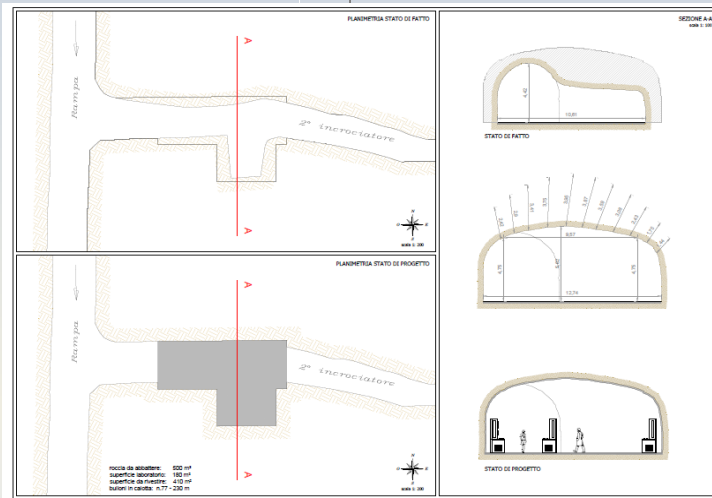
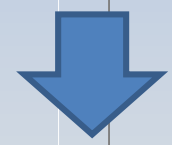
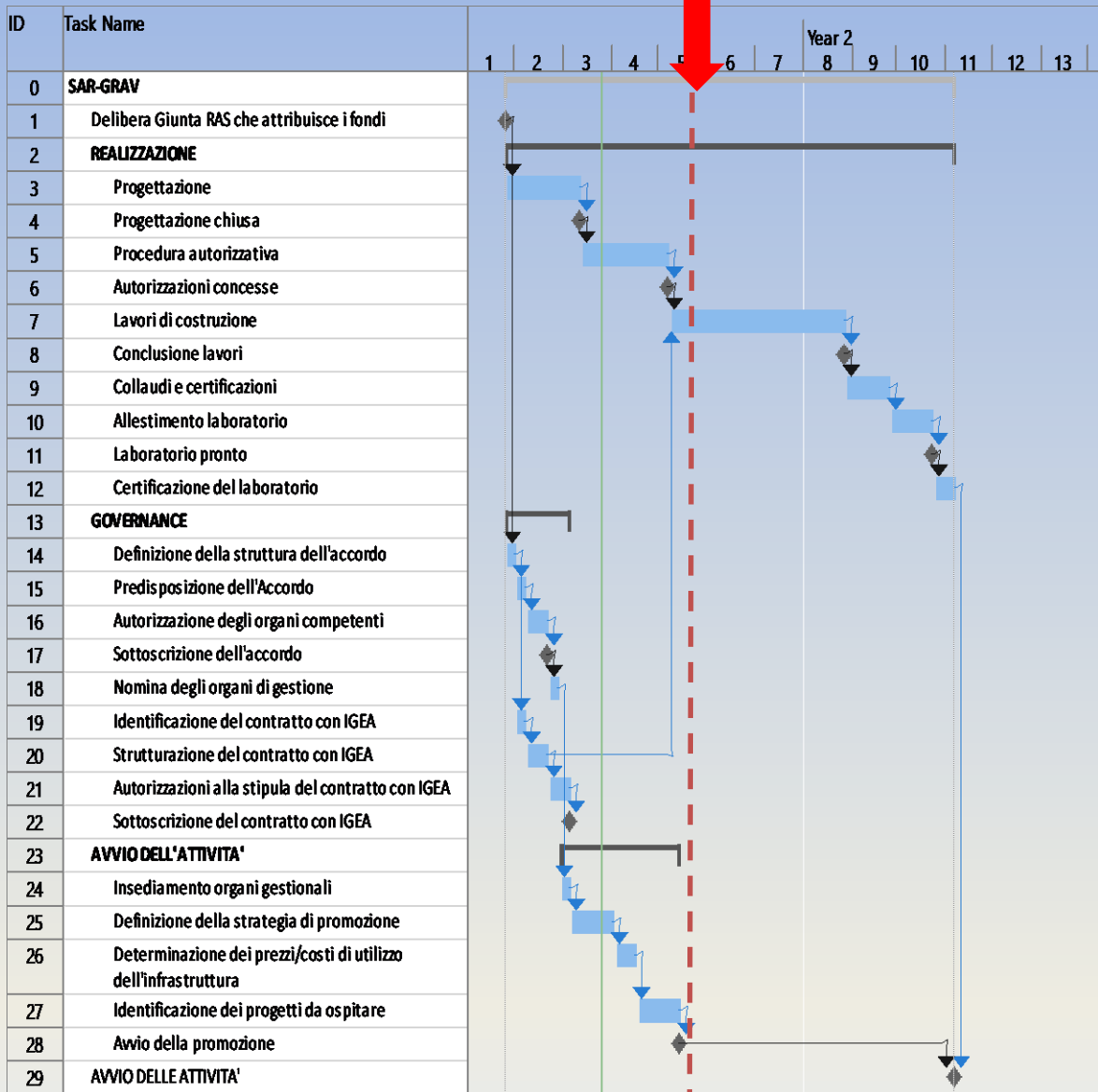

We are expected to bring in Sos-Enattos the new version of the balance with the vacuum system being the inner chamber of the cryostat within next summer (2019)

The Archimedes project

People – Timeline - Costs

S. Avino, A. Basti, E. Calloni, S. Caprara, R. De Rosa, L. Errico, F. Frasconi, G. Gagliardi, M. Grilli, M. De Laurentis, E. Majorana, G.P. Pepe, S. Petrarca, G. Pillant, P. Puppo, P. Rapagnani, F. Ricci, L. Rosa, N. Saini, C. Stornaiolo, D. Stornaiuolo, F. Tafuri.

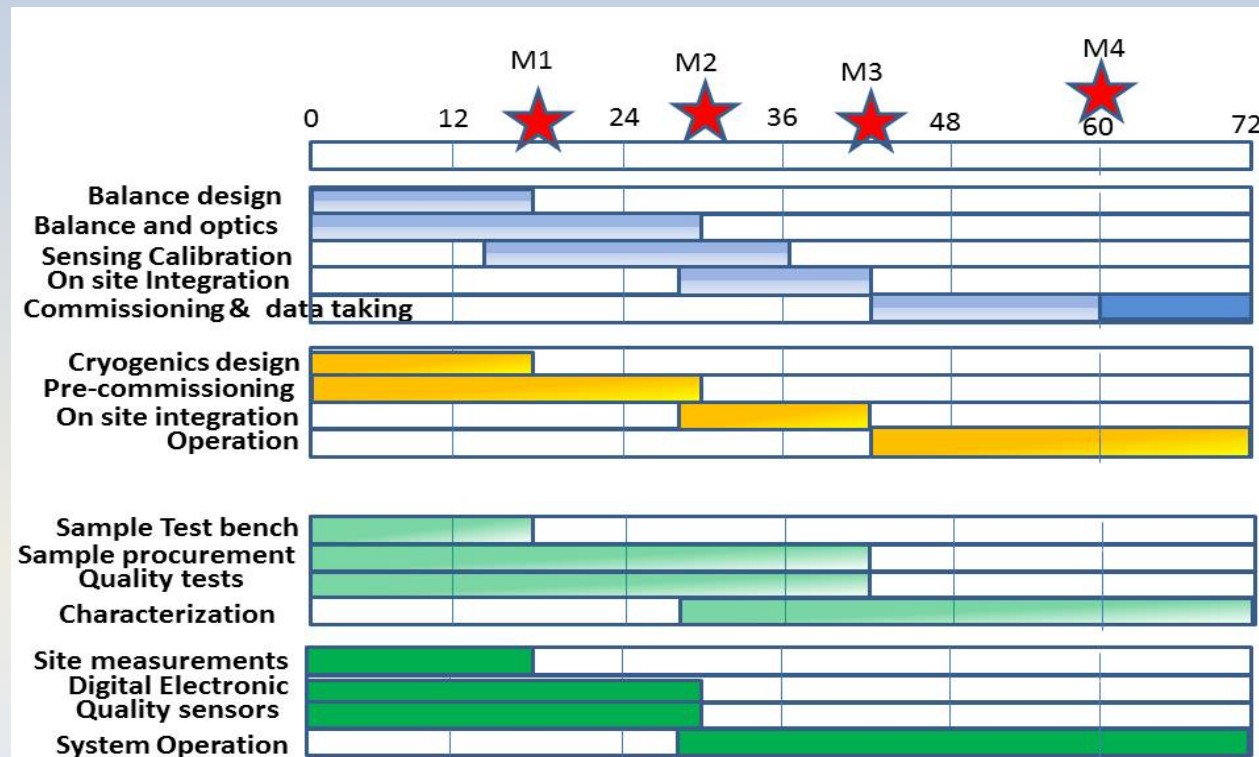

Total duration 6 years
Total equipment cost
1 Meuro

$T_0 = \text{Jan-2018}$

Conclusion

The experiment is small but lot of work is expected in next years – open to collaborations

Sardinia is waiting for you!



(picture shown at GWADW meeting in Alaska..)

SPARES

Experimental problem: modulate Casimir energy without exchanging too much energy with the system (to not destroy the possibility of measurement and control) and measure it.

LASER

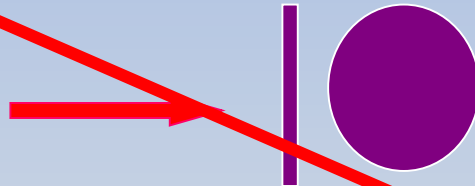

The energy E sent to the film is about 5×10^5 J

The variation of casimir energy ΔE_{cas} is about 2.5×10^{-19} J

The efficiency is $\varepsilon = \Delta E_{\text{cas}}/E = 10^{-14}$

Modulation of Casimir energy with superconductors (type I)

Pressure red-shift

A simple summation of the lower force and upper force on the plates would bring to a somewhat unsuspected result:

$$F_{\text{inf}} + F_{\text{sup}} = F_{\text{cas}} (1 + \delta\phi) + \frac{|E_C|}{c^2} g - F_{\text{cas}} = 4 \frac{|E_C|}{c^2} g$$

$$F_{\text{cas}} = -L^2 \frac{\pi \hbar c}{240 a^4}$$

$$E_{\text{cas}} = -L^2 \frac{\pi \hbar c}{720 a^3}$$

The lower vacuum «photons» must exert a bigger force because the force will be red-shifted when reaching the same level of upper plate → in the experiment the sum must be done taking into account the red-shift because the cavity is rigid and hanged in a unique point - **(for this effect our measurement is a null measurement on pressure red-shift)**

$$\left\{ \begin{array}{l} F_{\text{sup}} = F_C \\ F_{\text{inf}} = -F_C (1 + \delta\phi) + \frac{|E_C|}{c^2} g \end{array} \right. \longleftrightarrow \vec{F}_{\text{tot}} = \frac{|E_C|}{c^2} g \hat{z}$$

E. Calloni et.al. Phys. Letters A, 297, 328-333, (2002)

G. Bimonte, E. Calloni, G. Esposito, L. Rosa - Phys. Rev D 74, 085011 (2006)

G. Bimonte, E. Calloni et. al. Phys.Rev.D76:025008, (2007)

G. Bimonte, E. Calloni, L. Rosa, Phys.Rev.D77:044026, (2008)

5

On interpretation of Tolman-Ehrenfest effect:

C. Rovelli, M. Smerlak Class. Quant. Grav. 28 (2011) 075007

Casimir Energy variation in real material

$$\Delta E_{\text{cas}}^0(a, d) = A \frac{\hbar}{2} \int \frac{dk_1 dk_2}{(2\pi)^2} \left\{ \sum_p (\omega_{\mathbf{k}_\perp, p}^{(n, TM)} + \omega_{\mathbf{k}_\perp, p}^{(n, TE)}) - \sum_p (\omega_{\mathbf{k}_\perp, p}^{(s, TM)} + \omega_{\mathbf{k}_\perp, p}^{(s, TE)}) \right\} \quad (1)$$

where $A \gg a^2$ is the area of the cavity, $\mathbf{k}_\perp = (k_1, k_2)$ denotes the two-dimensional wave vector in the xy plane, while $\omega_{\mathbf{k}_\perp, p}^{(n/s, TM)}$ ($\omega_{\mathbf{k}_\perp, p}^{(n/s, TE)}$) denote the proper frequencies of the TM (TE) modes, in the n/s states of the film, respectively.

Cauchy integral formula and renormalization



$$\left(\sum_p \omega_{\mathbf{k}_\perp, p}^{(n, TM)} - \sum_p \omega_{\mathbf{k}_\perp, p}^{(s, TM)} \right)_{\text{ren}} = \frac{1}{2\pi} \int_{-\infty}^{\infty} d\zeta \left(\log \frac{\Delta_n^{(1)}(i\zeta)}{\tilde{\Delta}_{n\infty}^{(1)}(i\zeta)} - \log \frac{\Delta_s^{(1)}(i\zeta)}{\tilde{\Delta}_{s\infty}^{(1)}(i\zeta)} \right)$$

where

$$\Delta_{jl}^{TE} = \frac{K_j - K_l}{K_j + K_l}, \quad \Delta_{jl}^{TM} = \frac{K_j \epsilon_l(i\zeta) - K_l \epsilon_j(i\zeta)}{K_j \epsilon_l(i\zeta) + K_l \epsilon_j(i\zeta)},$$

$$K_j = \sqrt{\epsilon_j(i\zeta) - 1 + p^2}, \quad I = n, s; \quad j, l = 1, 2, n, s.$$

And inserting it in (1)

$$\Delta E_{\text{cas}} = A \frac{\hbar}{2} \int \frac{d\mathbf{k}_{\perp}}{(2\pi)^2} \int_{-\infty}^{\infty} \frac{d\zeta}{2\pi} \left(\log \frac{Q_n^{TE}}{Q_s^{TE}} + \log \frac{Q_n^{TM}}{Q_s^{TM}} \right)$$

where

$$= \frac{Q_I^{TE/TM}(\zeta, p)}{(1 - \Delta_{1I}^{TE/TM} \Delta_{12}^{TE/TM} e^{-2\zeta K_1 L/c})^2 - (\Delta_{1I}^{TE/TM} - \Delta_{12}^{TE/TM} e^{-2\zeta K_1 L/c})^2 e^{-2\zeta K_I D/c}}{1 - (\Delta_{1I}^{TE/TM})^2 e^{-2\zeta K_I D/c}}$$

Ragguagli teorici

L. Rosa et al.. Casimir energy for two and three superconducting coupled cavities
Submitted to JPLP (2017)

E. Calloni et al Towards weighing the condensation energy to ascertain the Archimedes force of vacuum
Phys.Rev. D90 (2014) no.2, 022002

G. Bimonte, E. Calloni et. al. Relativistic mechanics of Casimir apparatuses in a weak gravitational field
Phys.Rev.D76:025008, (2007)

G. Bimonte, E. Calloni , G. Esposito, L. Rosa - Energy-momentum tensor for a Casimir apparatus in a weak gravitational field Phys. Rev D 74, 085011 (2006)

G. Bimonte, E. Calloni et al Towards measuring variations of Casimir energy by a superconducting cavity
Phys.Rev.Lett. 94 (2005) 180402

E. Calloni et.al. Vacuum fluctuation force on a rigid Casimir cavity in a gravitational field Phys. Letters A, 297, 328-333, (2002)

Da questo punto di vista, ritengo che la misura proposta da ARCHIMEDES sia di eccezionale interesse. Si tratta dell'unico esperimento di laboratorio di cui io sia a conoscenza che possa oggi dare informazioni sperimentali dirette sull'interazione fra energia di vuoto e gravità, e in particolare confermare l'esistenza di effetti fisici per i quali abbiamo oggi solo previsioni teoriche, in un contesto generale di notevole confusione teorica.

Superconduttività

- ❑ E' stato aggiunto un WP all'esperimento ed aggiunti FTE efficaci.
- ❑ Varie ditte ri-contattate per YBCO



High T_c
for Pract

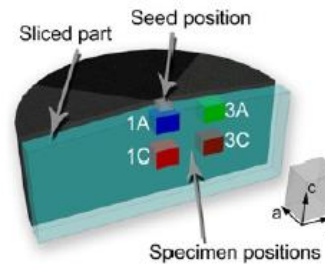

characterization for YBCO levitation bulk 14mm dia, 6mm

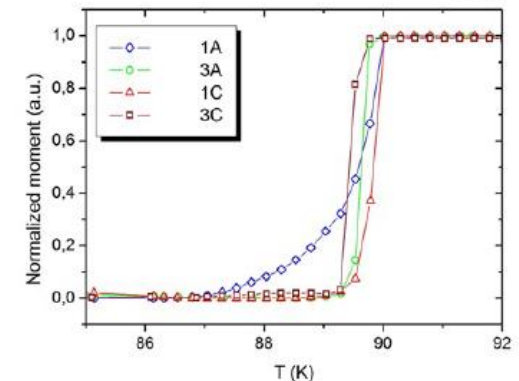
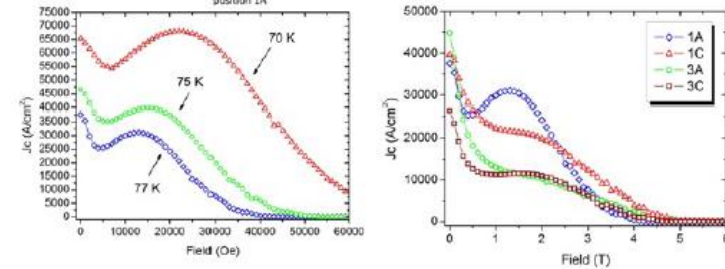

Inserita tra le milestone la realizzazione di un apparato per la misura di energia di transizione in dischi di grande dimensione. Questo è necessario per mantenere il controllo nel laboratorio delle caratteristiche dei materiali e perché ad una prima indagine non risulta che esista un tale apparato. Le indagini continueranno.

Attuazione termica (Roma)

- Modulazione della temperatura del campione superconduttore attraverso il solo scambio radiativo per non aggiungere altra energia diversa da quella legata alle fluttuazioni del vuoto

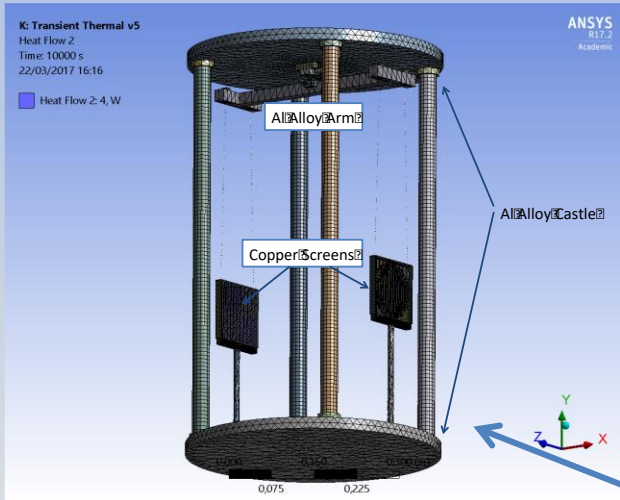

Criostato Virgo lavo



Prototipo Bilancia (Napoli)

Torque sensitivities and signal

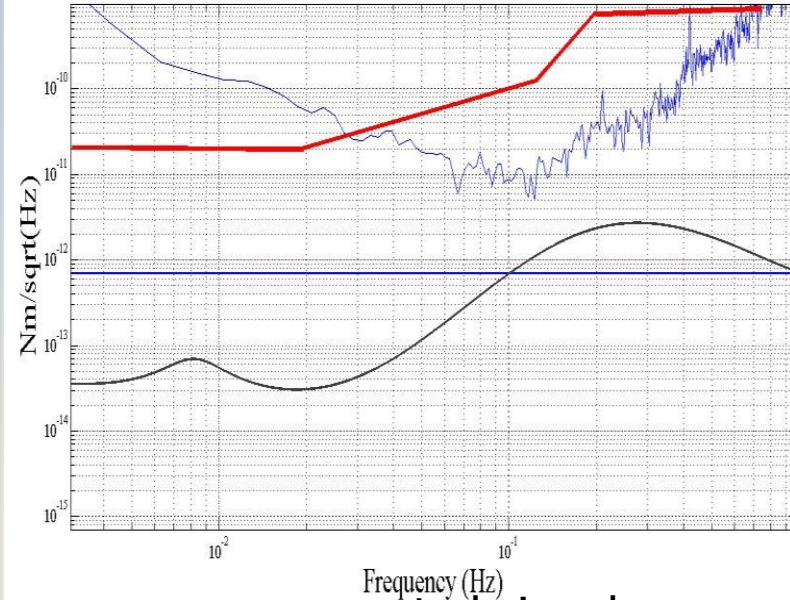

Case with only radiative heat exchange

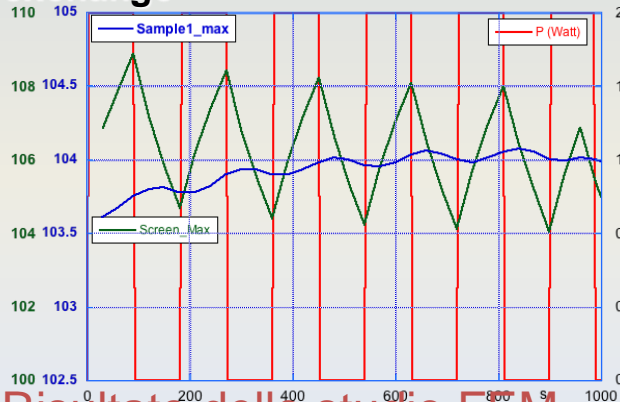

2' diam, 5 mm thick substrate for YBCO

- expected signal
- prototype
- Wash
- Archimedes noise

Risultato dello studio FEM

A side-measurement (more difficult): the weight of the entropy*T

$$\Delta U = G_n(T) + TS_n(T) - G(T, 0) - TS_s(T, 0)$$

Difference in internal energy for a transition at fixed temperature

$$G_n(T) - G_s(T, 0) = \frac{1}{2\mu_0} B_c(T)^2$$

$$B_c(T) = B_0 \left[1 - \left(\frac{T}{T_c} \right)^2 \right]$$

$$S_n(T) - S_s(T) = 2 \frac{B_0^2}{\mu_0} \left(\frac{T}{T_c^2} \right) \left[1 - (T/T_c)^2 \right]$$

Difference in entropy for a transition at fixed temperature valid for BCS – approximately for layered type II

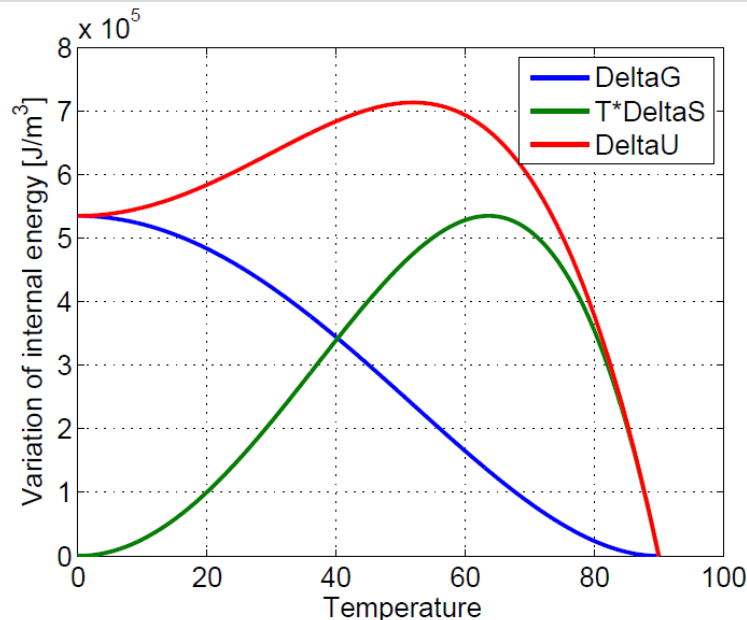

*Disregarding in this particular discussion the contribution of Casimir effect the weight of the entropy (times Temperature) can be considered as an interesting **side-measurement** of the final experiment. This weight is classical (no question on it) but never measured*

Use of superconductors

- The condensation energy is very small so it can be expected that the variation of Casimir energy at the transition for a superconductor inside a cavity can be of the same order, or even dominates, the total transition energy

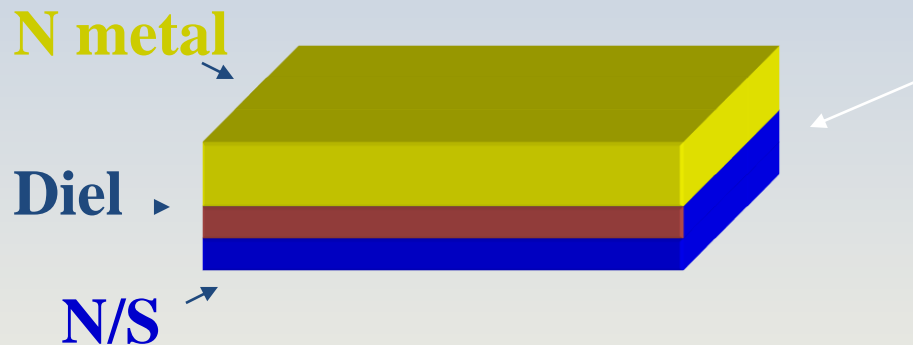

$$\frac{V}{2\mu_0} \left(\frac{B_{c||}^{\text{cav}}(T)}{\rho} \right)^2 = \mathcal{E}_{\text{cond}}(T) + \Delta E_{\text{cas}}(T)$$

The change in energy can be calculated following the Casimir energy calculation in case of real plates with complex conductivity σ

$$\Delta E_C = -\Delta\eta_E \frac{\hbar c \pi^2}{720} \frac{A}{L^3}$$

$\Delta\eta_E$: modulation factor with respect perfect reflectivity

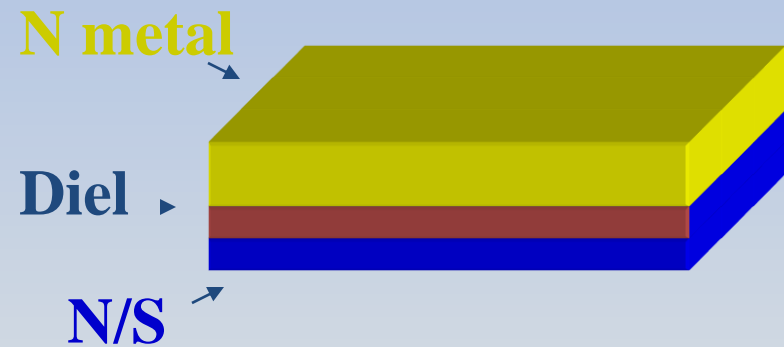

$$\Delta\eta_E = \frac{\Delta E_C}{E_C} \approx \frac{kT_C}{\hbar\nu_C} = \frac{kT_C}{hc/L} \approx 10^{-6}$$

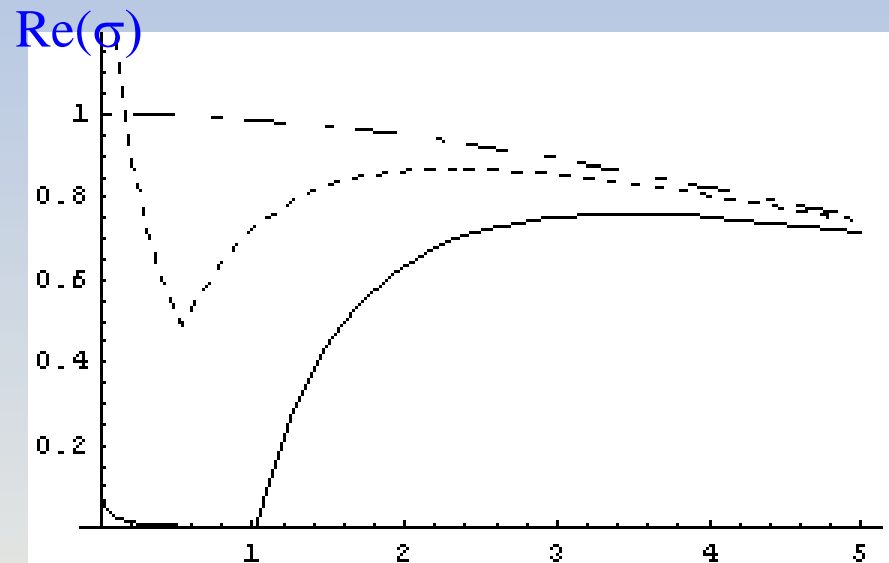

$$x = \hbar\omega/(2kT_c)$$

Plot of real part of conductivity σ normalized to zero frequency Drude conductivity σ_0 for different temperatures:

— · · — $T = T_c$ (Drude) $T/T_c = 0.9$ ——— $T/T_c = 0.3$

The conductivity changes only in the very low frequency region (microwave) so the modulation depth (if T_c is of the order of 1 K) is expected to be small for small T_c .

..but also the energy exchanged with the system, besides the vacuum energy, is expected to be small being linked to the condensation energy which is (roughly) proportional to T_c^2 . Better to use low T_c superconductors. If the two energy variations are comparable then it is expected that vacuum fluctuations modifies the transition

Is there a way to measure ΔF_c ?

Superconductivity is destroyed by a critical magnetic field .



The proposed way to measure ΔF_c consists in placing the cavity in a parallel magnetic field and measuring the critical field that destroys the superconductivity of the film.

Results and references on energy modulation – Aladin Experiment

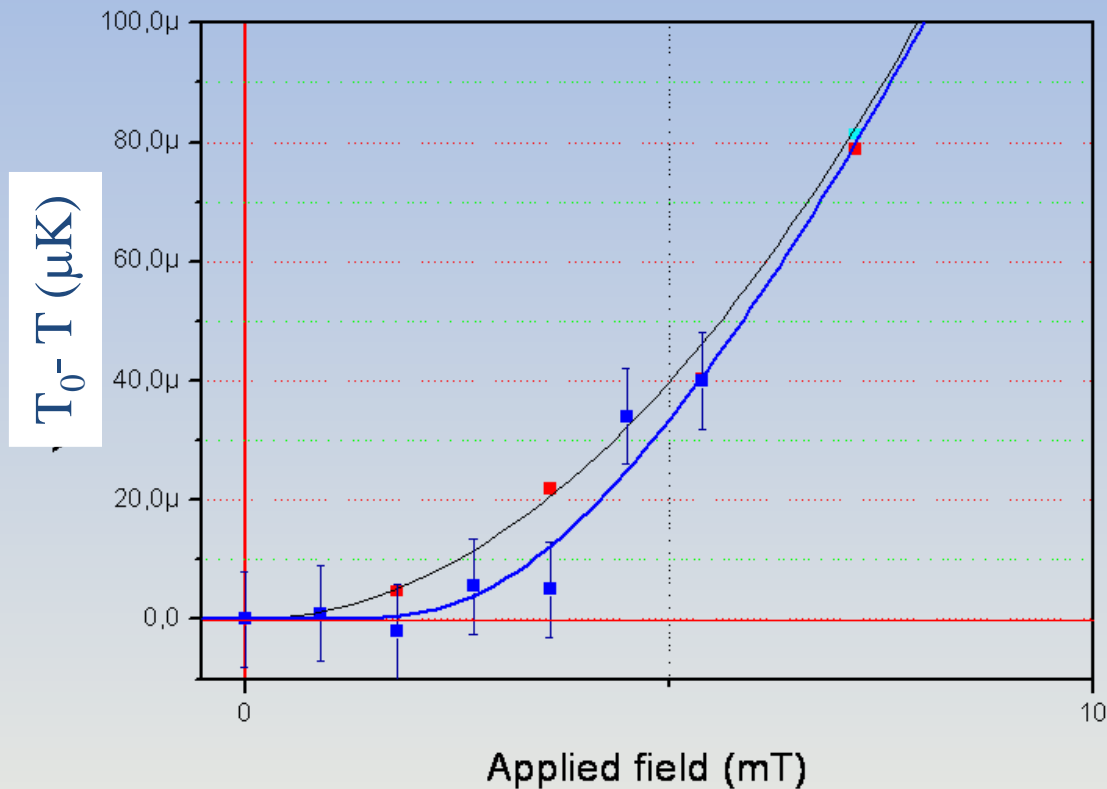

The data are not in contrast with the theory and the region of energy of different behaviour is the expected one

2008

G. Bimonte, et Al. - Nucl.Phys. B726 (2005) 441-463

G. Bimonte et Al. - Phys.Rev.Lett. 94 (2005) 180402

G. Bimonte et Al. - J. Phys. A: Math. Theor. **41** 164023 (2008)

A. Allocca et Al. Jour. Of. Supercond. And Novel Magnetism. **25**, 2557-2565 (2012)

Tilt sensitivity with long optical lever

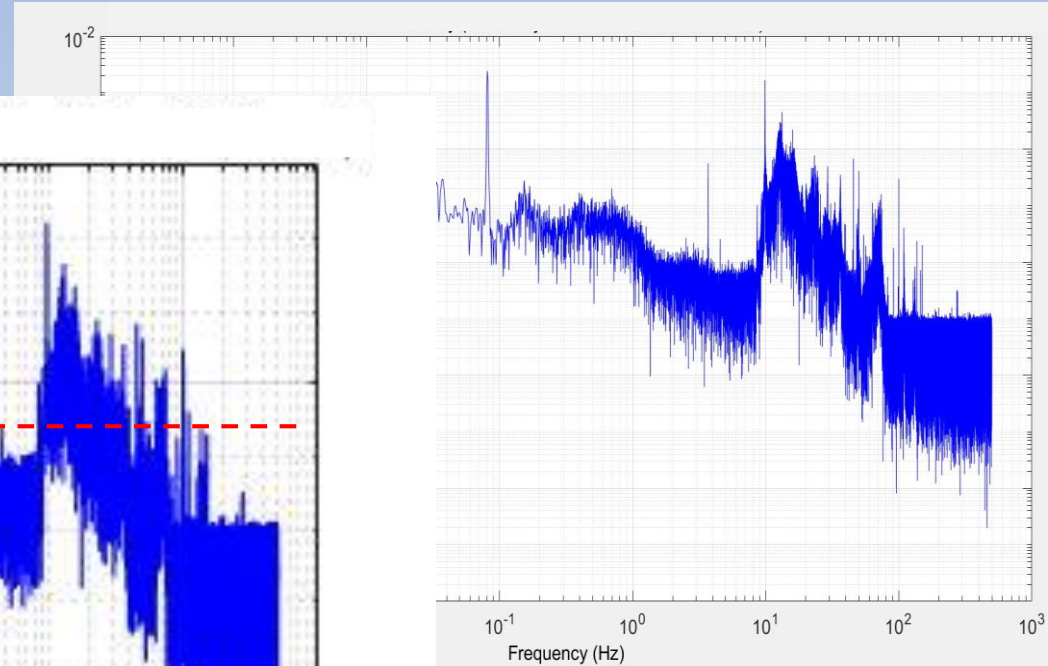
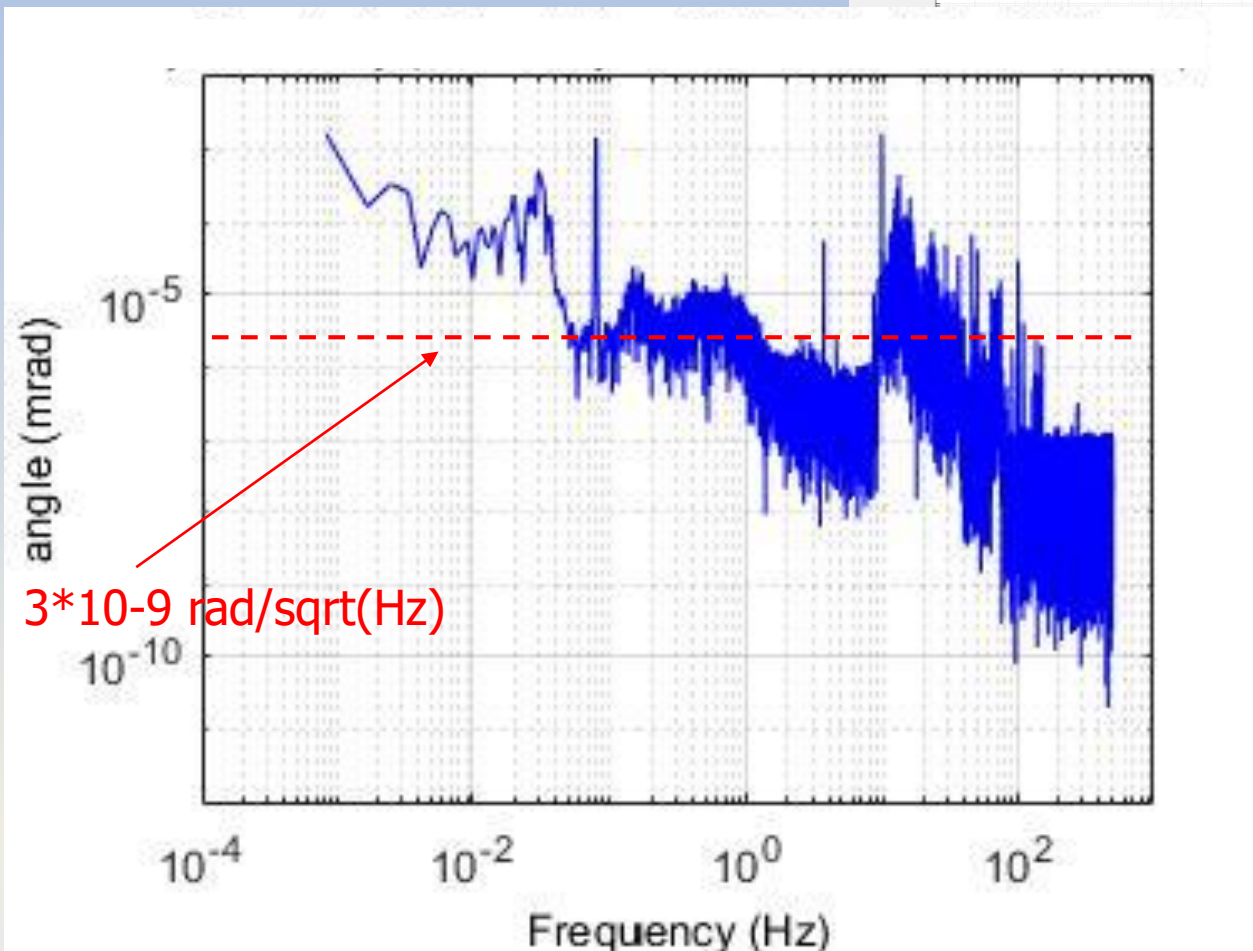

Closed loop tilt signal
in mrad/sqrt(Hz)