

Physics of neutrino oscillation

G. De Rosa

T2K group

Fisica delle oscillazioni di neutrino a Napoli

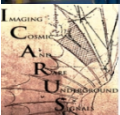
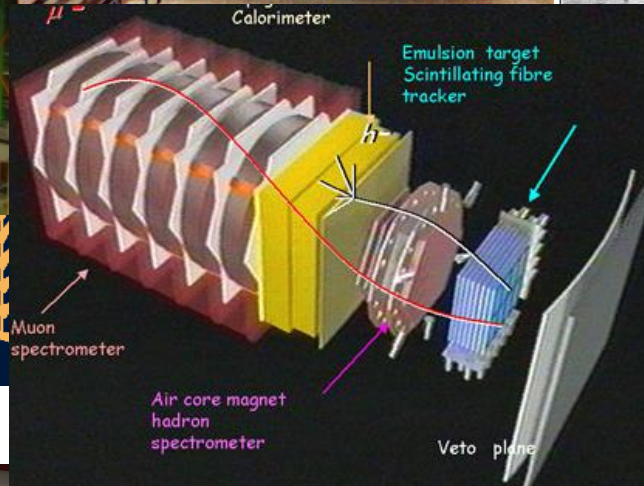
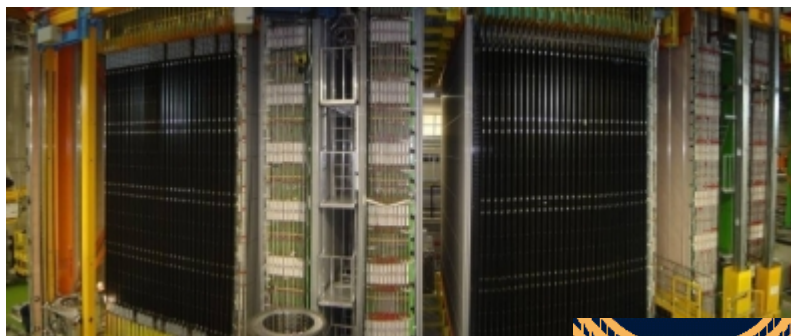
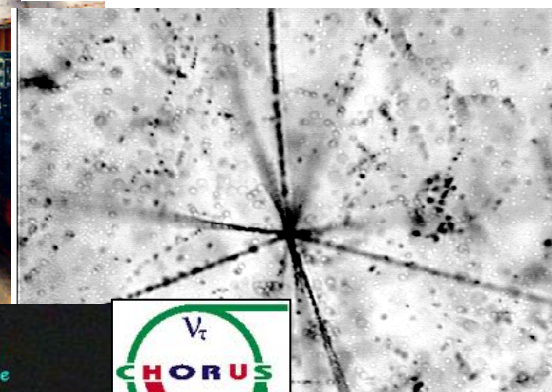
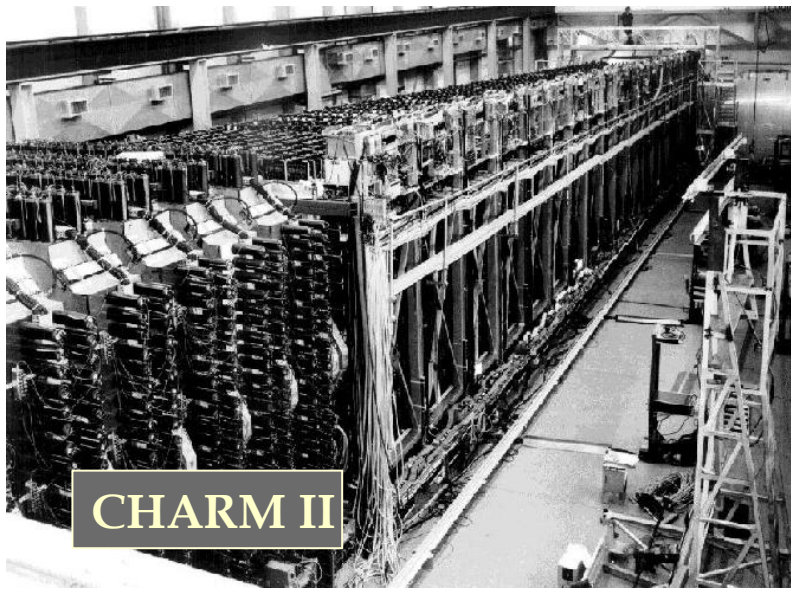

Imaging Cosmic And Rare Underground Signals

....e la storia continua!

ν oscillation «on beam»: Esperimenti in corso e progetti futuri

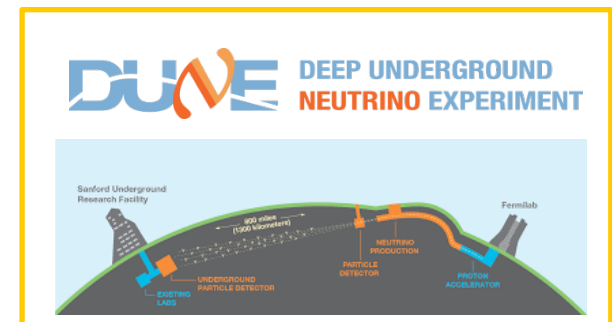
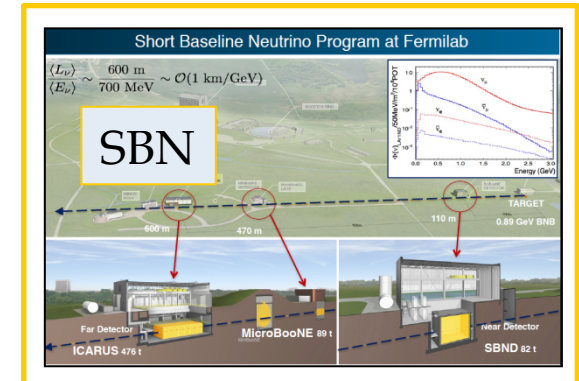
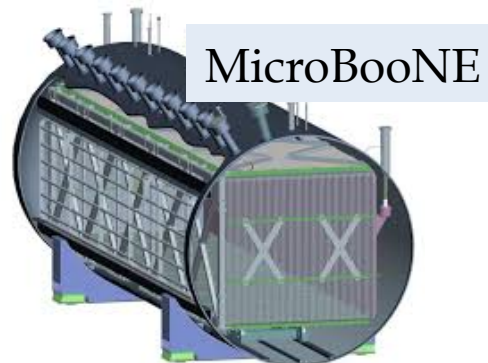
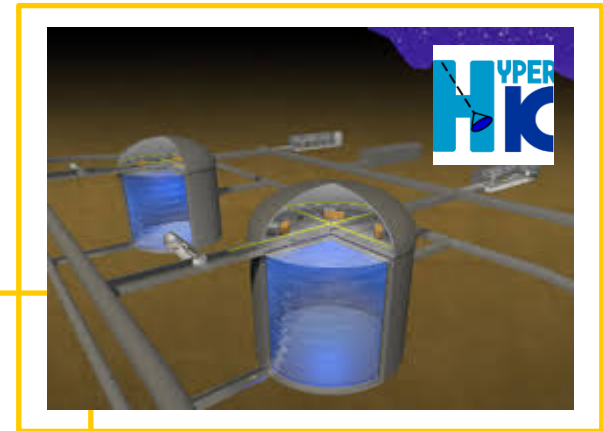
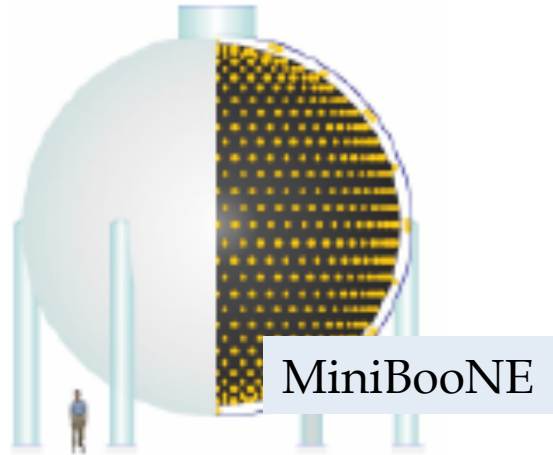

Neutrino Oscillations at T2K

Science Goals of T2K

- discovery of $\nu_{\mu} \rightarrow \nu_e$
- precision measurements of oscillation parameters
- search for sterile components
- world-leading contributions to (anti) ν -nucleus cross-section measurements

ν_e appearance in a ν_{μ} beam aiming next at a far reaching discovery of leptonic CPV effects

Recent result $\delta = -\pi/2$ and NH
CP conservation $\delta = 0, \pi$ excluded at 90% CL
T2K Collaboration, Phys. Rev. Lett. 118, 151801 -
Published 10 April 2017 - Editors' Suggestions

About 30 publication in the last 3 year;
more other in preparation

T2K Activities in Naples

- Analysis of Nu contamination in Antineutrino beam
- Measurement of CC0 π nu and antinu cross section to study MEC effect:
 - 4-7 possible future paper based on this analysis
 - Collaboration INFN/LPNHE/CEA
 - Collaboration T2K-NA group and Prof. Giulia Ricciardi

Argomento di interesse INFN discusso a «What Next» Febbraio 2016

Fondi esterni:
project JENNIFER (Strategic objective: H2020 MSCA-RISE-2014).

Premi:
Fundamental Physics Breakthrough prize 2016

Super-Kamiokande

Dal 2017 l'INFN partecipa (con un piccolo gruppo di cui fa parte anche Napoli) anche sul far detector (esperimento SK) (insieme ai gruppi UK e Canada).

Questa attività nell'ottica di

- Ampliare i goals di fisica agli studi "senza acceleratore"
- Migliorare l'integrazione fra le varie comunità all'interno dell'esperimento
- Sviluppare competenze sui WC di grandi dimensioni, in vista della realizzazione dell'intermediate detector e oltre.

Attività previste per il gruppo italiano:

- Progettazione e realizzazione di un nuovo (piccolo) rivelatore per il monitoring dell'electron LINAC utilizzato per la calibrazione (partecipazione Napoli)
- Misure di radiopurezza del Gadolinio: previsti test a LNGS
- Sviluppo generatore compatto (con trigger) neutroni per SK
- Misure di cattura neutroni su Gadolinio a LNL
- Partecipazione al data taking e all'analisi



ENUBET

Enhanced NeUtrino BEams from kaon Tagging

Tutte le misure di sezioni d'urto dei neutrini alla scala del GeV sono dominate dall'incertezza sistematica sul **flusso iniziale**. Questa incertezza è la **sistematica dominante** negli esperimenti di prossima generazione per la violazione di CP. E' possibile ridurla in modo sostanziale usando **fasci di neutrino convenzionali**?

Idea di base [A. Longhin, L. Ludovici, F. Terranova *Eur. Phys. J. C* 75 (2015) 155]

Utilizzare un fascio di ν_e prodotti quasi esclusivamente dai decadimenti $K^+ \rightarrow e^+ \pi^0 \nu_e$ e monitorare il rate di produzione di positroni nel tunnel di decadimento

ERC Consolidator Grant (2016-2021) [ENUBET, PI: A. Longhin]

Progetto nato durante INFN What Next per la realizzazione di un dimostratore completo

Iniziativa fortemente collegata alle attività di R&D per futuri esperimenti di oscillazione di neutrino

Partecipazione del gruppo di Napoli alle attività di test e di simulazione

T2K-II

J-PARC neutrino beam upgrade

	Now (achieved)	2020	~2025
p/spill	2.4×10^{14}	2.2×10^{14}	3.2×10^{14}
cycle	2.48s	1.3s	1.16s
power	470kW	800kW	1.3MW

Near Detector upgrade

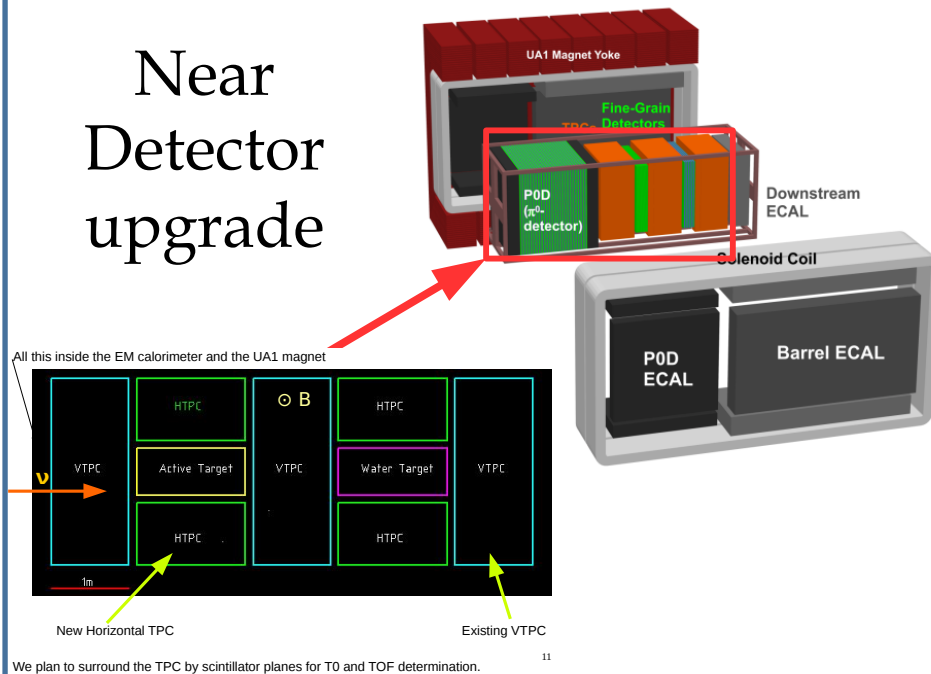

Intermediate Detectors

- Water Cherenkov detector at ~1-2 km
- Same technology as the far detector
- Far/Near errors cancelation

Two proposals: TITUS/nuPRISM

Off-axis angle spanning orientation.
Gd loading, magnetized μ range detector.

Will merge in unique detector



Construction 2020-2023 (?)

Intermediate Detectors

Multi-PMT system with small PMTs (DOM) as in Km3Net

- Proposed by INFN-NA
- First prototype will be realized in Naples
- Studies and test undergoing in Naples on acrylics



Attività Napoli:

Il primo prototipo sarà realizzato entro l'esate del 2017

Test del prototipo previsti in sede e presso altri laboratori in Italia e Giappone; studi di ottimizzazione del sistema di read-out dei PMTs;

studi di ottimizzazione del design del sistema multiPMT;

Studi su acrilici:

Misure di trasparenza a Napoli (thanks Proff. Maddalena e Velotta)

Test meccanici al Politecnico di Bari con la partecipazione del gruppo di Napoli

Misure di contaminazione radioattiva realizzate a Napoli (thank Prof. Roca) e programmate ai LNGS

Misure di assorbimento dell'acqua presso il laboratorio CIRCE in collaborazione con il gruppo KM3NeT di Napoli

ND280 Upgrade

Expression of Interest (EOI) EOI-15 @ Neutrino Platform (CERN): T2K Near Detector upgrade looking forward (HyperK/Dune)

- Signed by 190 people (including a CERN group)
- Submitted to SPSC early January
- First contact with referees and questions received

One project, two goals

- Study, optimize, design and build an upgrade of the ND280 near detector capable of improved and model-independent precision below $\sim 4\%$ in line with T2K-II physics needs
- Study, optimize, design a High Pressure TPC that could serve as base for a detector aimed at exploring the details of neutrino interactions. Demonstrate the concept with prototypes on a test beam.

We identified synergies and strong overlaps in the interests expressed by the participating groups. Associating the two projects will strengthen the collaboration.

8

Expression of Interest for the January 2017 SPSC

Near Detectors based on gas TPCs for neutrino long baseline experiments¹

R. Hamacher-Baumann, L. Koch, T. Rademacher, S. Roth, J. Steinmann
RWTH Aachen University, III. Physikalisches Institut, Aachen, Germany

K. Banerji, M.G. Cabanes, R.A. Ichimi, L. Magaletti, E. Radicioni
INFN and Dipartimento Intersezione di Fisica, Bari, Italy

S. Bortoni, M. Caporaso Garrido, A. De Roeck, R. Gluza, J. Mandula,
D. Mladenov, M. Nuss, F. Reuter
CERN, Geneva, Switzerland

Z. Ljubic, J. Lopez, A. Marino, K. Nagai, E. D. Zimmerman
University of Colorado at Boulder, Department of Physics, Boulder, Colorado, U.S.A.

Y. Hayato, M. Ikeda, M. Akahata, Y. Nakajima, Y. Nakamura

- R&D Program based at CERN (Neutrino Platform) to develop both TPC and HPTPC for neutrino experiments
- Side subjects as Dark Matter searches or Double Beta Decay can be accommodated in case of common developments

ND280 Upgrade Timeline

- **2017:** pursue optimization studies, define preferred configuration, finalize WP structure and responsibilities, prepare and submit proposal for SPSC
- **2018** Prototype of TPC (field cage, micromegas) in a testbeam. Define the detector options (granularity etc). Prepare for production.
- **2019-2020** Production, integration at CERN. System test.
- **2021** Shipment to Japan, installation, commissioning.

Attività Napoli:

New Horizontal TPCs: Required very thin Field Cage.

Partecipazione del gruppo di Napoli alle attività

Find the best compromise in term of

Acceptance

Uniform field region

HV insulation

Amount and choice of material

Rigidity

Easy integration, ...

Technical design:

study different configurations through simulation

Integration of readout modules

Position of gas inlets/outlets

Surrounding support structure

Accessibility in basket

ND280 Upgrade: High Pressure TPC

Add new detectors in the 280m pit: High pressure TPC to study low momentum final state particles and in particular resolve vertex
 HPTPC detector design to reduce xsec systematics

[arXiv:1002.2680 \[hep-ex\]](https://arxiv.org/abs/1002.2680)

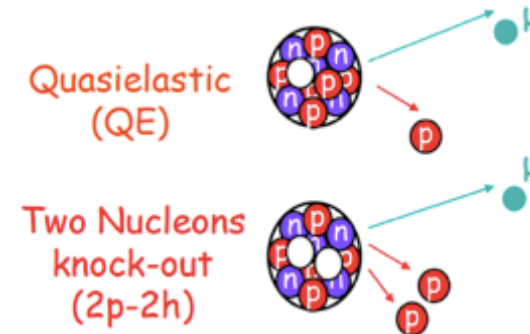
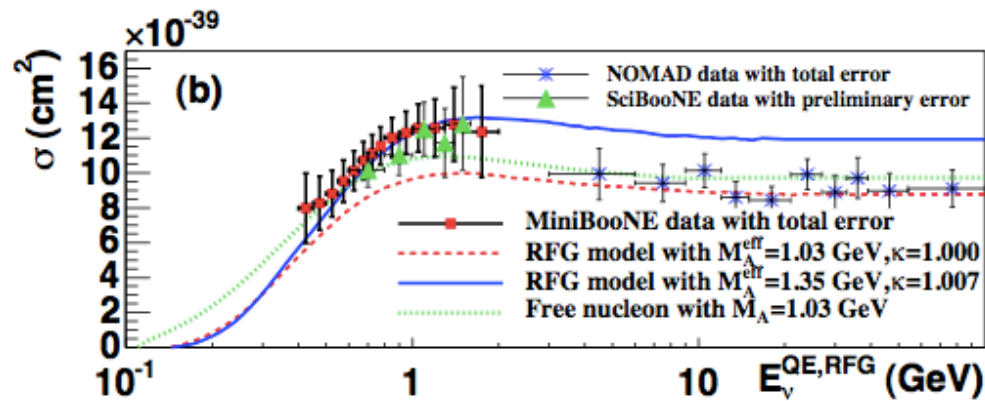

- Significant discrepancies on proton multiplicity and momentum distributions
- Need low momentum thresholds to reduce xsec systematics
- Important difference lie below threshold for liquid detectors

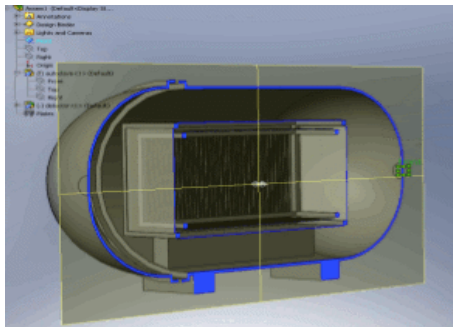

- T2K has pioneered (~1 bar) gas TPCs for accelerator neutrinos
- Need a path to high pressures for sufficient statistics
- Generic to next generation LBL experiments

ND280 Upgrade

- Con una statistica tripla (20×10^{21}) rispetto a quella attualmente approvata T2K potrebbe effettuare una prima misura ($\sim 3\sigma$) di violazione di CP se le indicazioni attuali ($\sim -90^\circ$) fossero confermate.
- L'upgrade del MR (750-900 KW) in fase di realizzazione (2018-2019) permetterà di raccogliere la statistica necessaria in circa 5 anni (2020-2025).
- Il PAC giapponese ha approvato lo *stage 1*. Lo *stage 2* (approvazione finale), necessita di un TDR (in preparazione => fine 2017-inizio 2018)

UPGRADE ND280 (2020-2021)

➤ Expression of Interest (EOI) SPSC-EOI-15 (nell'ambito di NP)

- 190 firmatari (fra cui un congruo gruppo del CERN)
- Interesse INFN (TPC, HPTPC, testbeams, Analisi)
- Un progetto 2 scopi (ND280 upgrade (T2K-II), HPTPC R&D (Dune,HyperK))
- Scala temporale ND280 upgrade (T2K-II) (richiesta fondi alla CSN2) =>

2018-2021

Un'ottima occasione per la comunità dei neutrini con acceleratori (oscillazioni)

Sviluppo di rivelatori di nuova generazione

Crescita di competenze (in particolare fra I giovani)

Produzione scientifica di ottimo livello

Sinergie con i progetti della generazione successiva (Dune,Hyperk)

Future project: DUNE and Hyper-Kamiokande

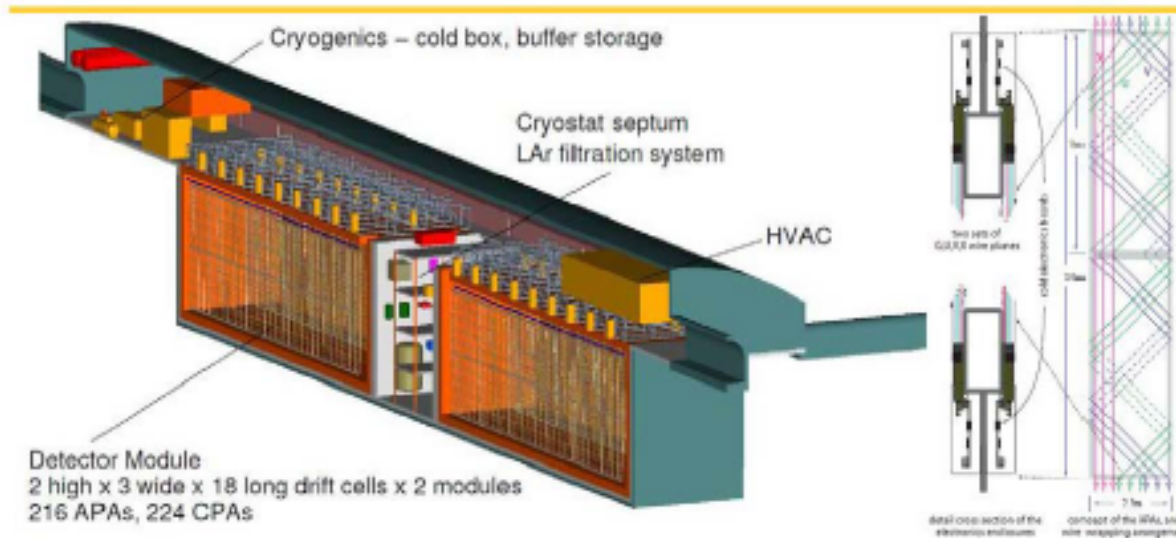
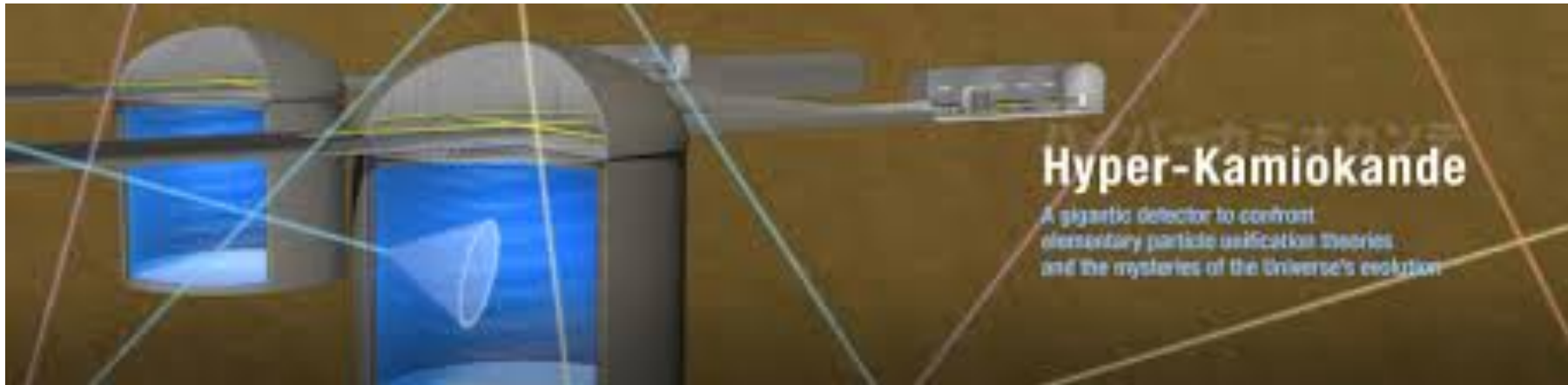

Two complementary approaches

- **HK:**

- short baseline → no matter effects: pure CP but reduced MH
- Off axis → reduced intrinsic ν_e contamination, reduced NC backgrounds

- **DUNE:**

- Long baseline → sensitive to matter effects: excellent performances in MH
- On axis: second oscillation maximum and sensitive to ν_τ appearance (tiny effects at 1300 km)
- On axis: extended lever of arm for measurement of oscillation parameters

Hyper-Kamiokande: overview

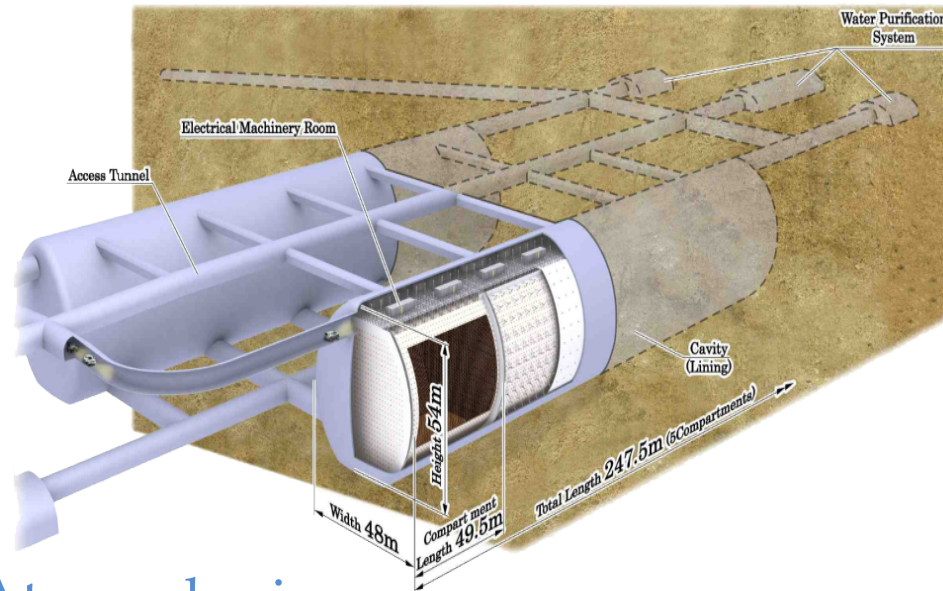

Hyper-Kamiokande is a multi-purpose **Water-Cherenkov detector** with a variety of scientific goals:

- ✧ Neutrino oscillations (atmospheric, accelerator and solar);
- ✧ Neutrino astrophysics;
- ✧ Proton decay;
- ✧ Non-standard physics.

Atmospheric ν

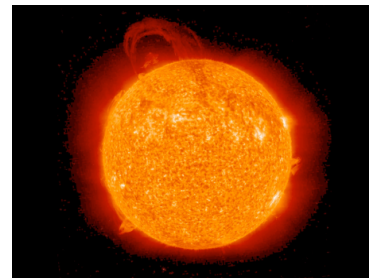
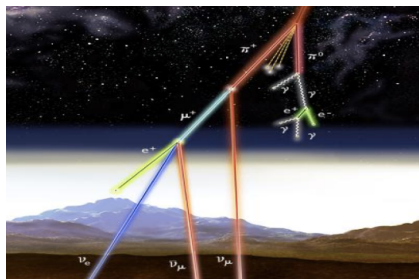

Solar ν

Supernova ν

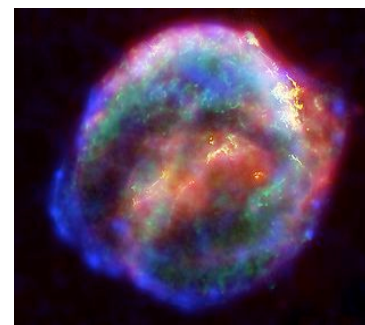

Accelerator ν

Multi-PMT system Proposed by INFN-NA
MoU with KM3Net to collaborate on MultiPMTs

Attività Napoli:
 R&D on mPMT option in HK
 G. De Rosa co-convener PD WG

Towards leptonic CP asymmetry

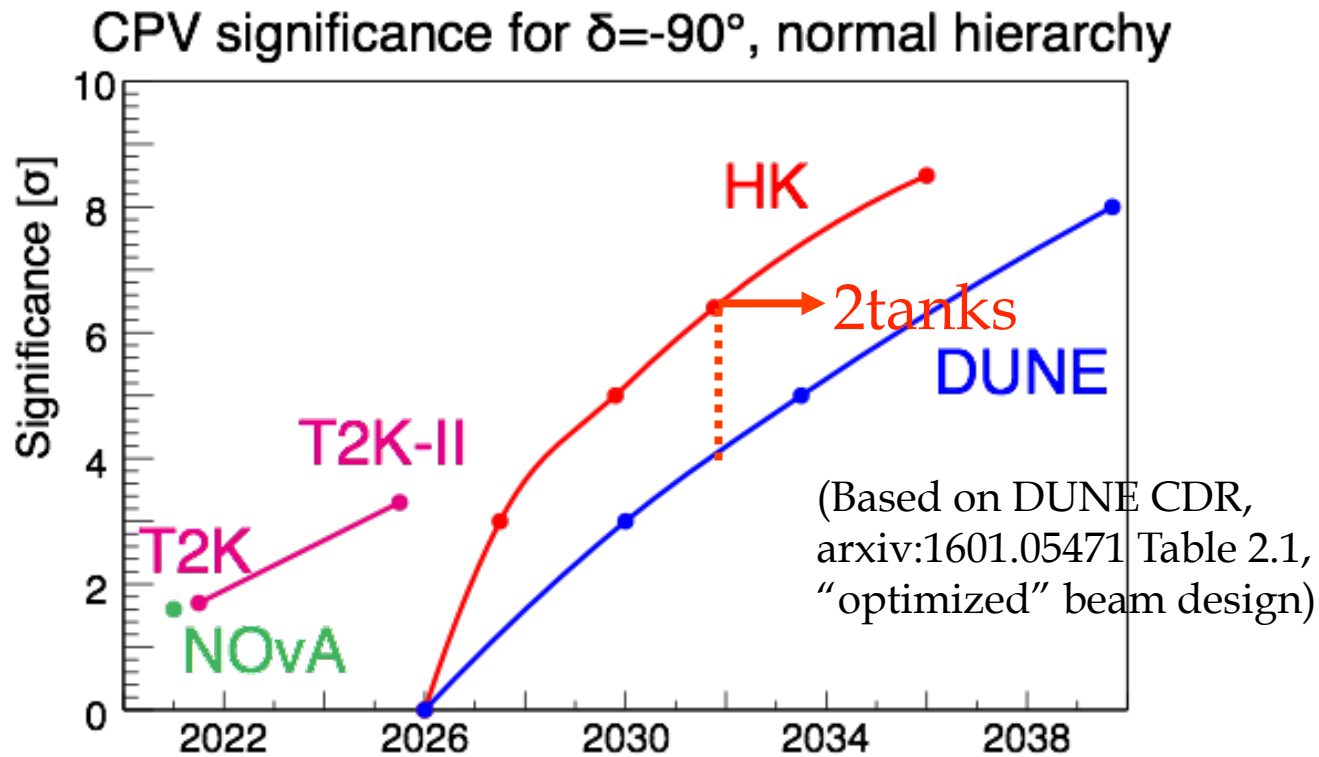

~3 σ indication with T2K \rightarrow T2K-II,
>5 σ discovery and measurement with HK/
DUNE

Note: "exact" comparison sometimes difficult due to different assumptions

Risorse

Risorse attuali

Prof. Ordinari: Vittorio Palladino

Prof. Associati: Giuliana Fiorillo

Ricercatori universitari: Gianfranca De Rosa

Ricercatore INFN: Biagio Rossi

Borsisti Post-doc: Alan Cosimo Ruggeri, Maria Bossa

Dottorandi di Ricerca: Ciro Riccio, 30mo ciclo

Risorse necessarie per il futuro

Assegno di ricerca

Giovani ricercatori

Backup slides

Sorgenti di errori sistematici

- Differenza accettazione Near/Far detector
- Bersaglio differente Near/Far (CH/H₂O)
- ✓ Sezioni d'urto non conosciute a bassa energia
- ✓ Near/Far ratio
- ✓ Discrepanze modelli teorici

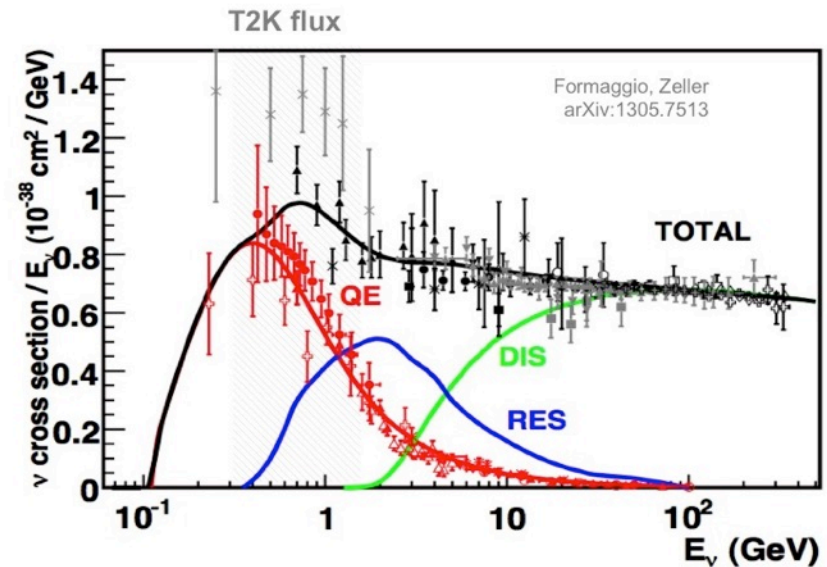
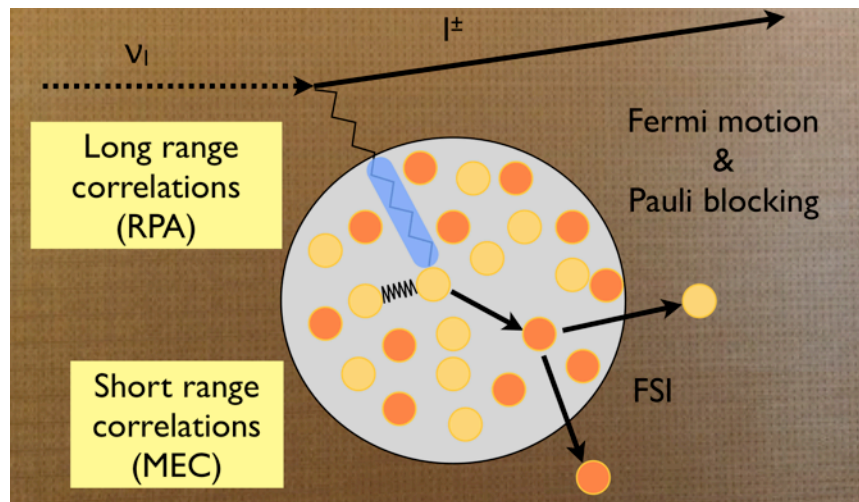
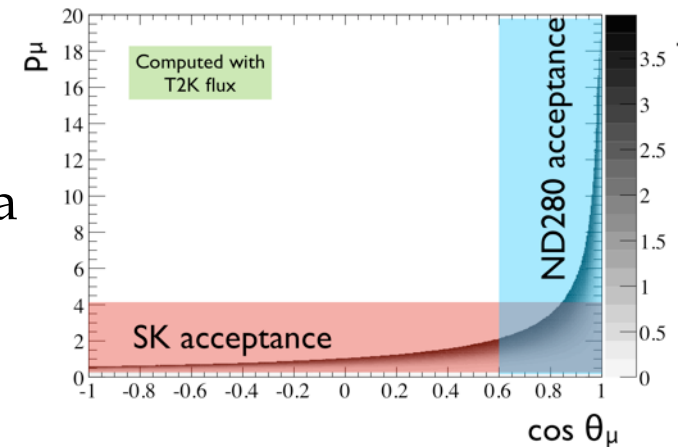

Impact on the DUNE CP sensitivity

DUNE CP discovery sensitivity (for NuFit2016 best-fit parameters)

Exposure: ≈ 10 -yr FHC + 10-yr RHC running (1.47×10^{21} POT/yr) with 40-kt fiducial FD)

Black: Full prior flux and interaction error. **Red: With HPGArTPC constraint.**

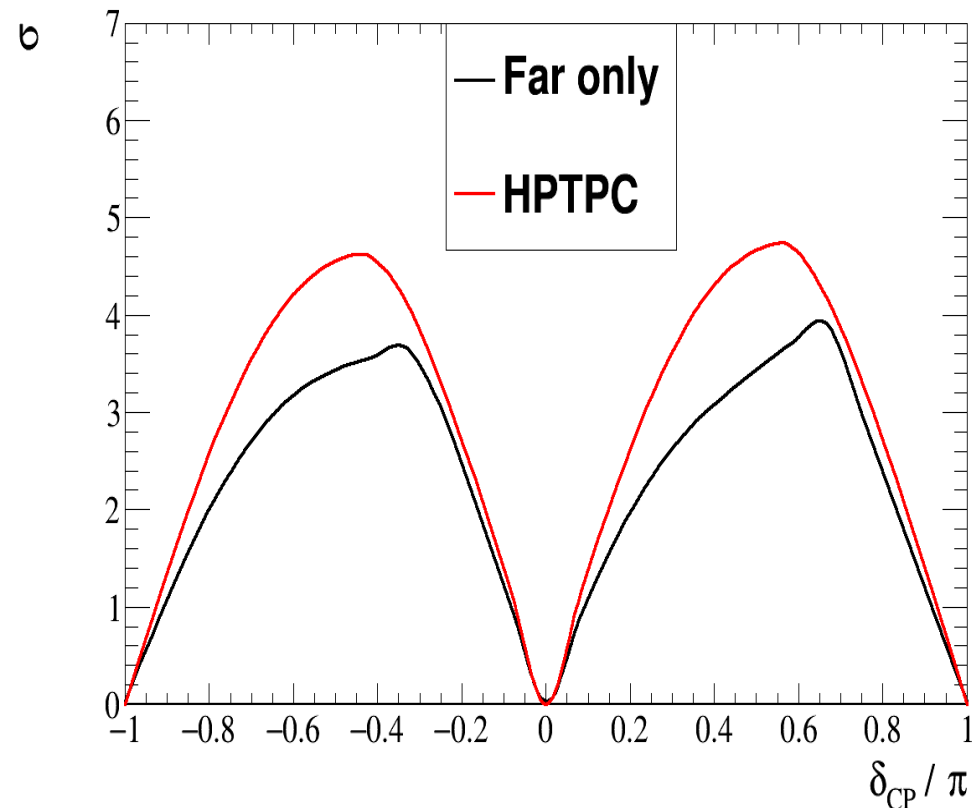

Dune



CP Violation Sensitivity

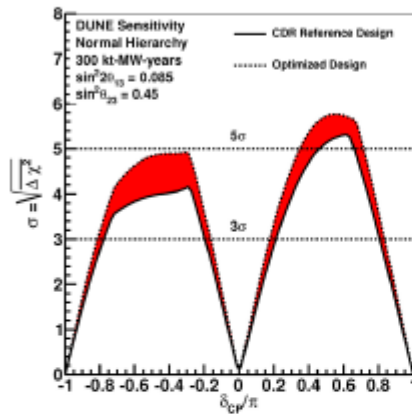

CP Violation Sensitivity

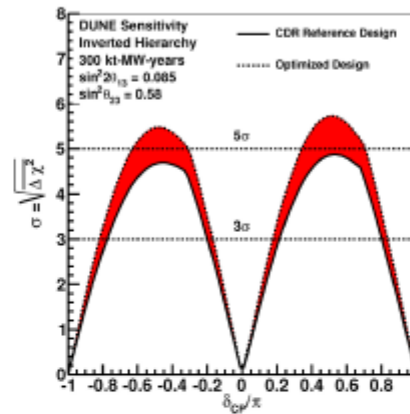

Significance	CDR Reference Design	Optimized Design
3 σ for 75% of δ_{CP} values	1320 kt · MW · year	850 kt · MW · year
5 σ for 50% of δ_{CP} values	810 kt · MW · year	550 kt · MW · year

Mass Hierarchy Sensitivity

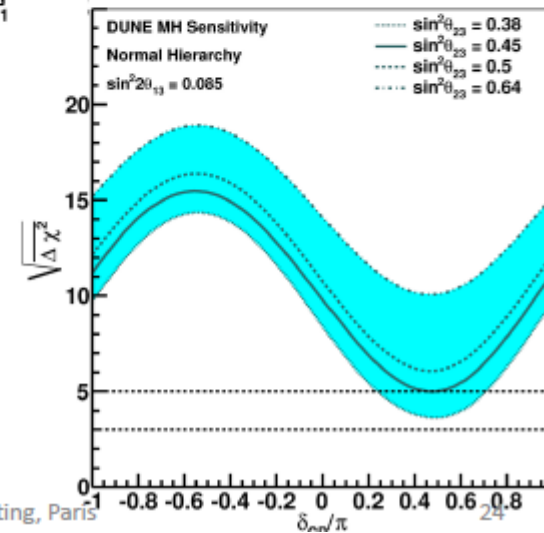

DUNE Experimental Strategy



“Long-Baseline Neutrino Facility (LBNF) and Deep Underground Neutrino Experiment (DUNE) Conceptual Design Report Volume 2: The Physics Program for DUNE at LBNF” (arXiv:1512.06148)

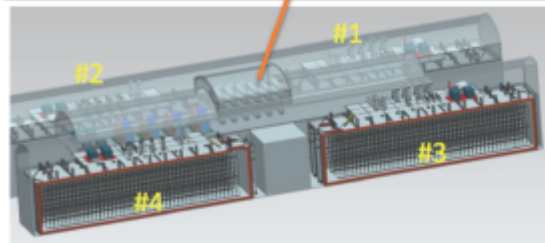
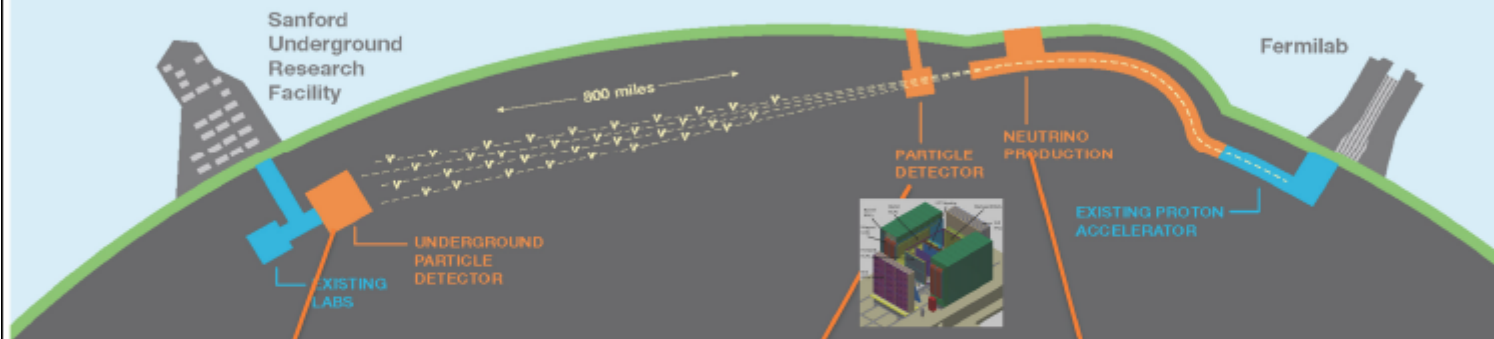

high precision
near detector complex

Wide band, high purity ν_{μ} beam with peak flux at 2.5 GeV operating at ~ 1.2 MW and upgradeable

- four identical cryostats deep underground
- staged approach to four independent 10 kt LAr detector modules
- Single-phase and double-phase readout under consideration

“Conceptual Design Report Volume 4: The DUNE Detectors at LBNF” (arXiv:1601.02984)



ENUBET

Enhanced NeUtrino BEams from kaon Tagging

A.Longhin (P.I.), L.Ludovici sono membri di T2K INFN

Tutte le misure di sezioni d'urto dei neutrini alla scala del GeV sono dominate dall'incertezza sistematica sul **flusso iniziale**. Questa incertezza è la **sistematica dominante** negli esperimenti di prossima generazione per la violazione di CP. E' possibile ridurla in modo sostanziale usando **fasci di neutrino convenzionali**?

Idea di base [A. Longhin, L. Ludovici, F. Terranova Eur. Phys. J. C 75 (2015) 155]

Utilizzare un fascio di ν_e prodotti quasi esclusivamente dai decadimenti $K^+ \rightarrow e^+ \pi^0 \nu_e$ e monitorare il rate di produzione di positroni nel tunnel di decadimento

$\nu_e, \bar{\nu}_e$ Cross Section Sensitivity Impact



- Perform sensitivity study where the ν_e and $\bar{\nu}_e$ cross sections are assigned two uncorrelated normalization systematic parameters
- The uncertainties on the normalization parameters are varied and the impact on the CPV sensitivity is studied.

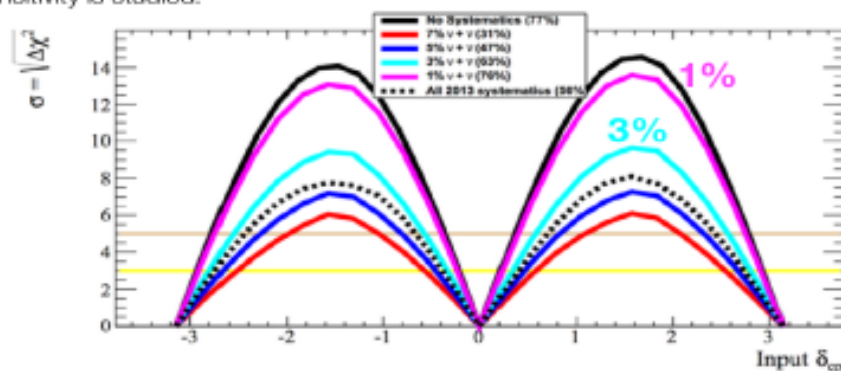

- The systematic uncertainty should be controlled to <1-2% to minimize the impact on the CPV discovery sensitivity