



Some Virgo History

Adalberto Giazotto
INFN Pisa



Some History on the Virgo Site Search

I think that not many Virgo peoples know the history connected with the search of Virgo site. Even this part of Virgo history has had many exciting and adventure episodes. The first direction, if I well remember, in which I was pushed has been a search of Virgo site on the sand dunes (Barene) in the region between Padova and Venice. There large areas were available but poor knowledge of soil resistance due to water presence made the choice impossible. This attempt lasted several month and required many trips to Legnaro. At same time I was writing several letters to Italian Republic Presidency Office for asking space on Presidential Park of S. Rossore.

My idea was to ask the use of fire-cutting roads for placing the two 3 km long Virgo arms. The answer was never negative and interlocutory; I was pointing on this direction because my hope was to obtain an acceptable counterproposition. Pisa University was asked to create a botanist committee, chairman Prof. Garbari, for evaluating the environment impact on S. Rossore Park.

Obviously response from Committee was very negative and the hope to build Virgo in a close site were slimming out.

But sometimes devil is not so dark: at the conclusive University meeting, after Garbari's negative report, one hand raised, it was the hand of the Cascina major, Franco Viegi, who declared to accept Virgo on his territory. Franco Viegi is hardly remembered but his courageous decision has been very instrumental for Virgo.

Some history about Virgo birth and Mirror suspensions

In the years 80' Bar detectors were the main interpreters of gravitational wave (GW) physics. At INFN there were pressures, seen the lack of reliable results with Cryogenic Bar detectors, to find new techniques for detecting GW

On our side the interest in the creation of a new extremely performant detector was pushing us toward a technical solution able to have a very strong Riemann force and very large bandwidth. At that time 2 ITF were running, Caltec 40 m Fabry Perot and 30 m Delay Line in Garching.

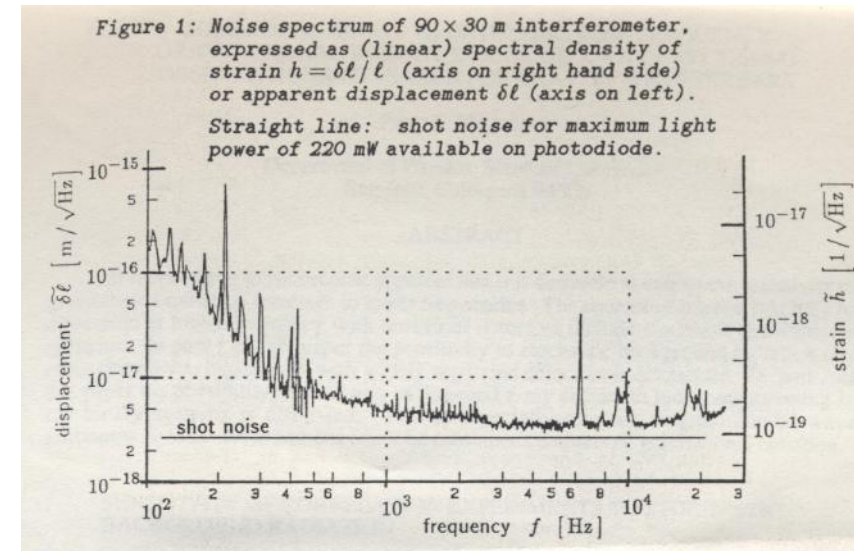
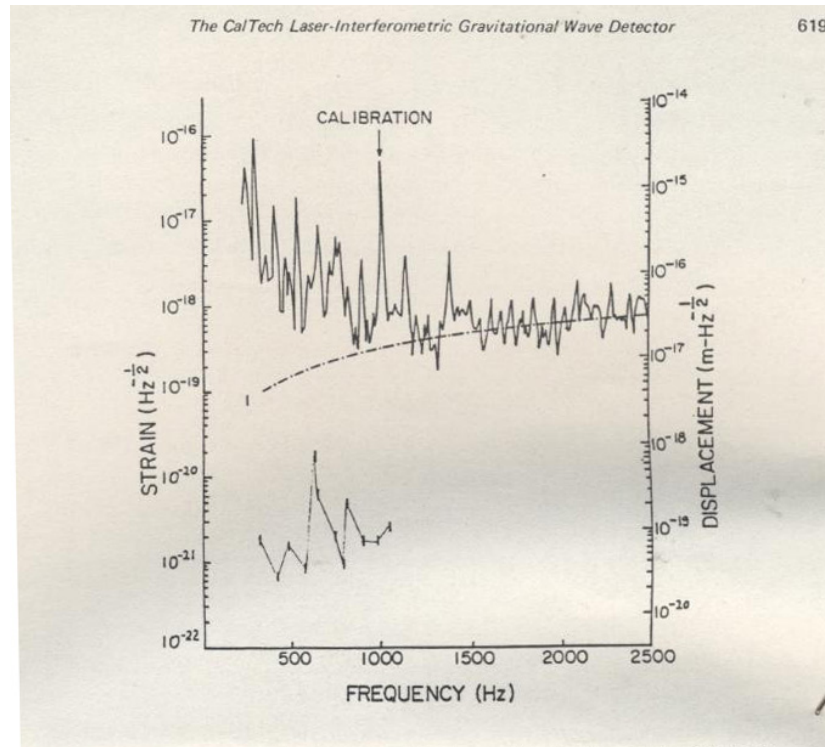

It seemed to us that the more promising solution should have been a large interferometer.

At that time results from Australian Radiotelescope in Marrabra led by Dick Manchester were giving very exciting results in the Pulsar detection. We realized that a relatively big number of Pulsar could have frequency > 10 Hz

This is the very transparent we used then

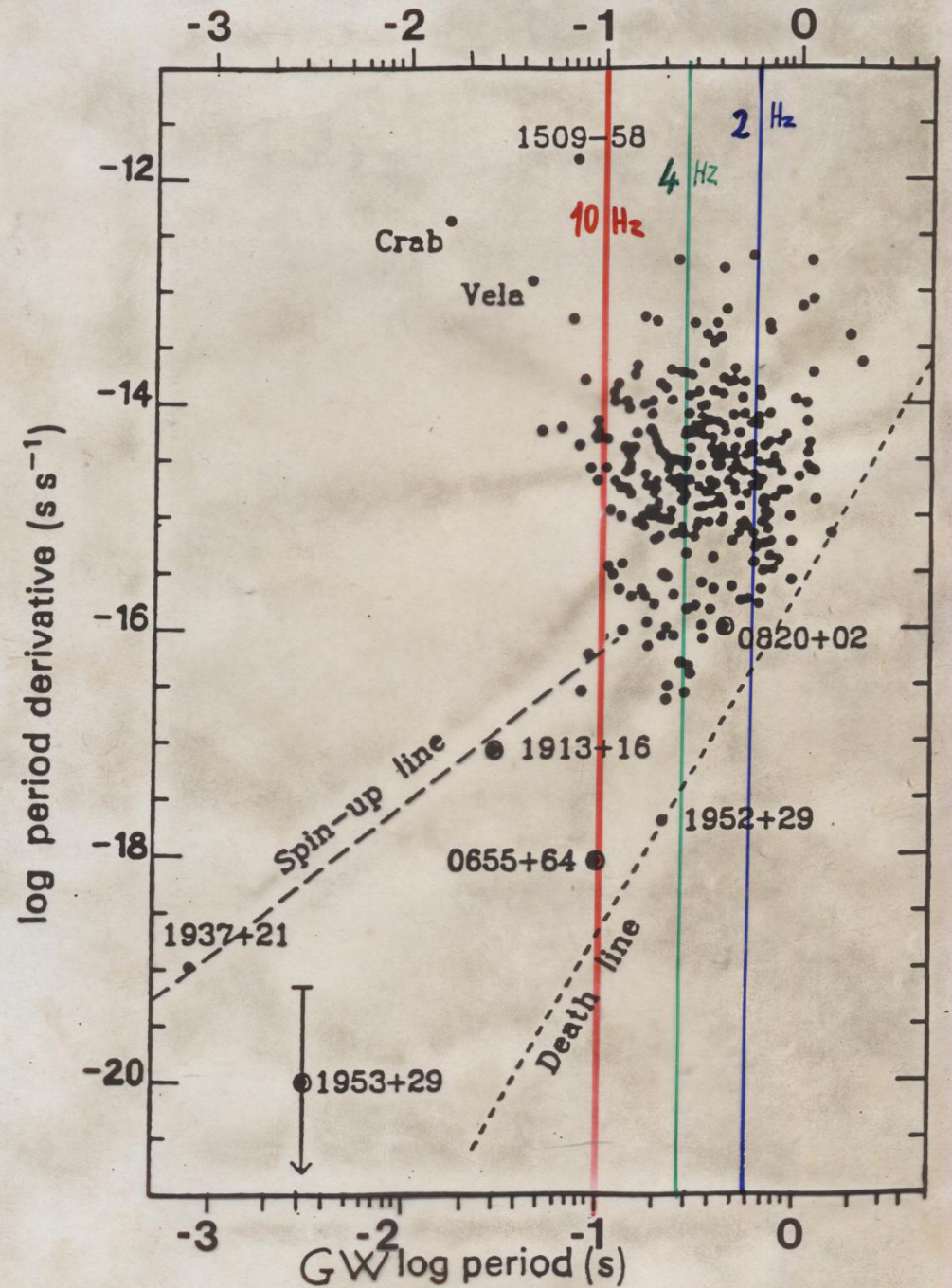

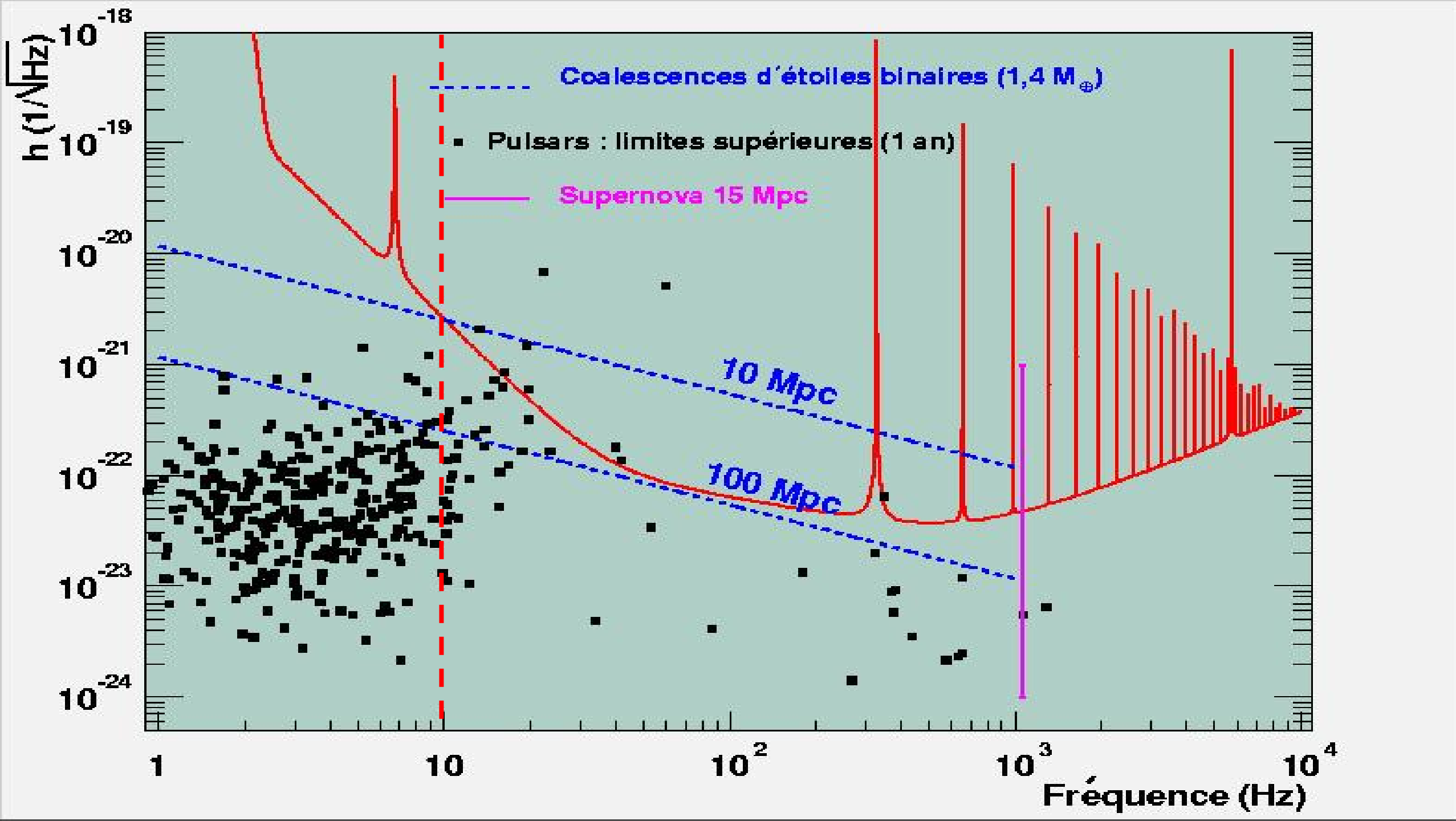

I decided to write a report in which I summarized all the noise evaluations intervening in a large interferometer going also to very low frequency. This report was very well accepted by the theory division of Pisa Physics Institute and become a reference where many strange noise sources were evaluated.

INTERFEROMETRIC DETECTION OF GRAVITATIONAL WAVES: THEORY AND NOISES.

A. Giazotto

PISA OCTOBER 1982

The problem was how to cut seismic noise of about 12 order of magnitude. Ron Drever and Jim Hough were attempting to create active inertial references. This led us to creation of an INFN funded experiment called IRAS (Interferometer for Seismic noise Active Reduction)

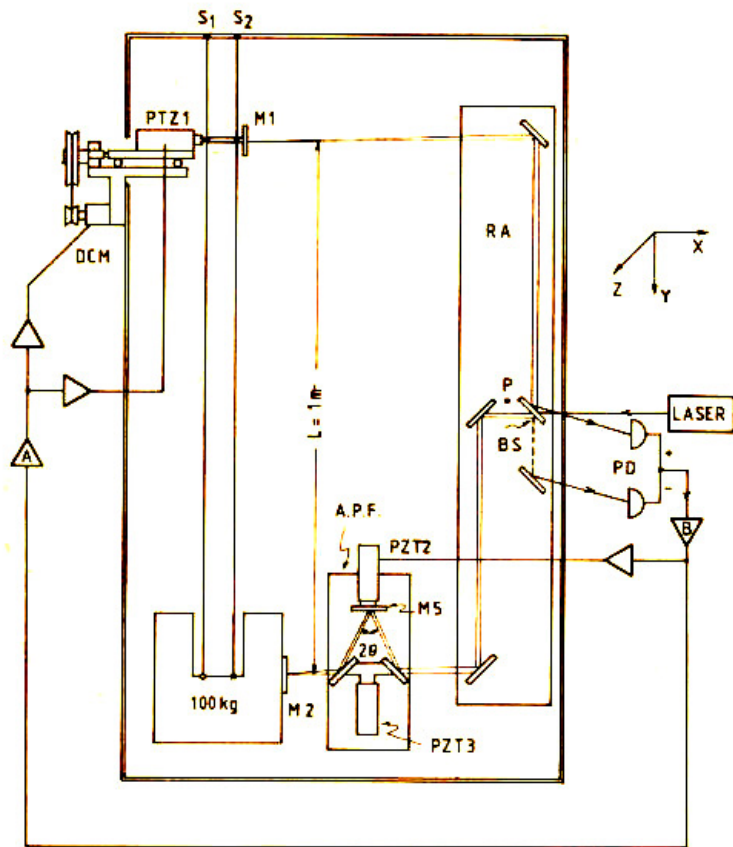

FIG. 3. Layout of the IRAS experiment including the interferometric sys-

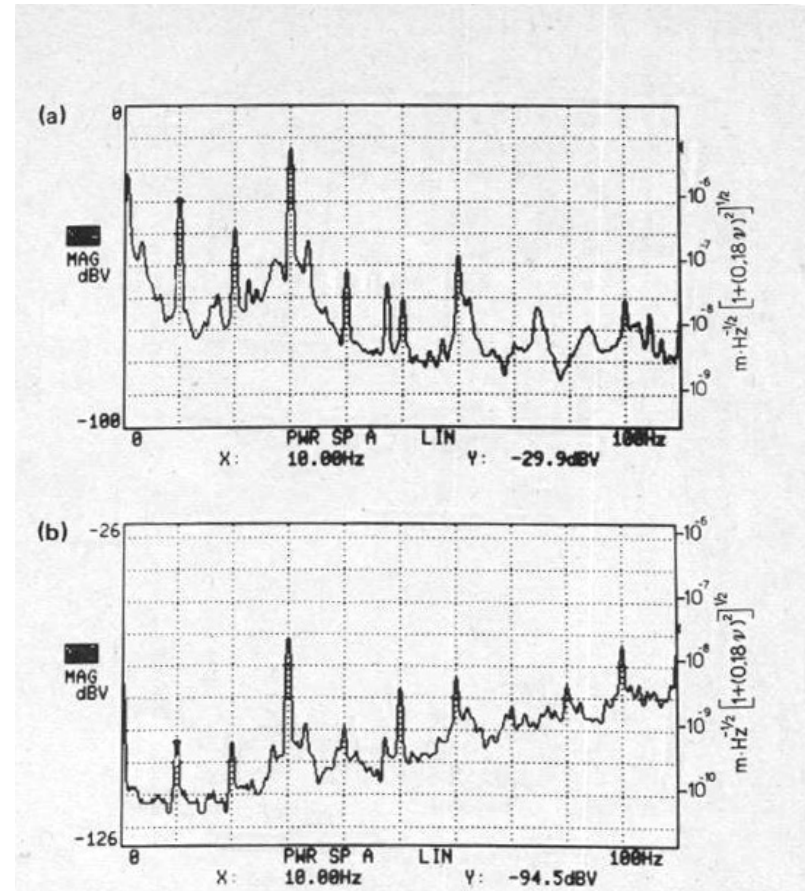

FIG. 6. The, RA locked-, open- (a), and closed- (b) loop frequency spectra for $0 < \nu < 100$ Hz.



This experiment was very important because it showed that a different method for killing seismic noise should be used.

At that time, June 1985, there was in Rome MG4 the fourth Marcel Grossman meeting on General Relativity. I was presenting IRAS results

One-mile equivalent length interferometric pendulum for seismic noise reduction

A. Giazotto, D. Passuello, and A. Stefanini

I. N. F. N. Sezione di Pisa and Dipartimento di Fisica, Università di Pisa, Pisa, Italy

(Received 9 August 1985; accepted for publication 14 February 1986)

We describe the performances of a 100-kg, 1-m-long active pendulum provided with a reference arm to get rid of the effects of tilting of the ground. The pendulum displacement with respect to the suspension point is measured interferometrically. The phase signal, to be sent to the actuator which displaces the suspension point, is extracted from the interferometer using an analog phase follower. At 10 Hz we obtain a virtual pendulum length of 1.7 km with the reference arm locked and 1.2 km when the reference arm is free. This device can be used to reduce the seismic noise in an antenna for low-frequency gravitational wave detection.

There I met Alain Brillet of CNRS- France and we decided that we had a common interest in building a big interferometer with Fabry Perot Cavities and extended bandwidth at low frequency. We decided to present Virgo Proposal to CNRS and INFN. This was the start of Virgo 3 Km. But then we had to present INFN-CNRS scientific results.

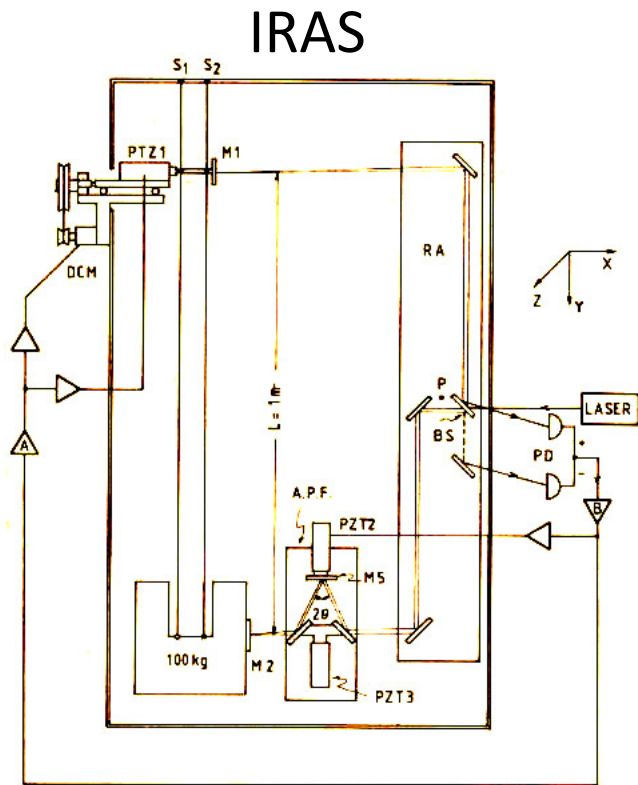
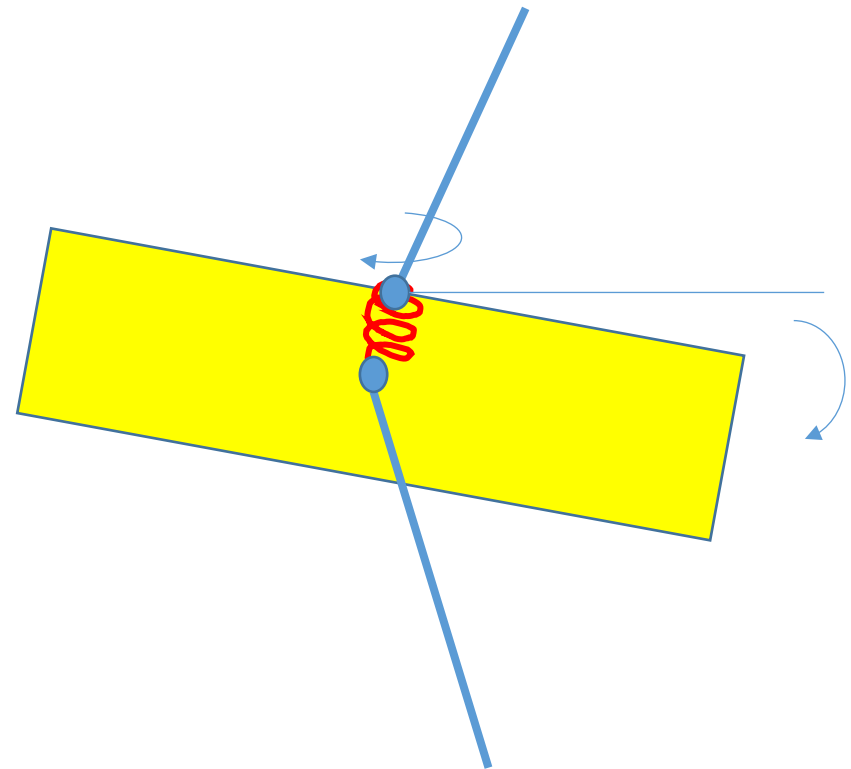

FIG. 3. Layout of the IRAS experiment including the interferometric system.

IRAS showed that attenuation in 1 DOF was already very complex, and we understood that a single filter should attenuate in 6 DOF of the rigid body.

We started thinking in a completely new direction: passive filters having very low vertical frequency and relatively low rotation frequency.



We tried to create a gas spring mechanical filter attenuating in the 6 DOF of the rigid body.

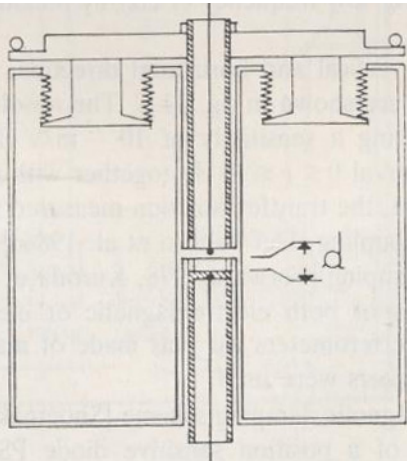

Fig. 11.5. The schematic diagram of a gas spring (from Del Fabbro et al. [1988a]). The gas pressure pushes the bellow piston, a load attached to the lower wire. A rigidity of 34×10^3 N/m with four bellows and of 20×10^3 N/m with two bellows was obtained.

And we built two chains of 7 filters under vacuum for measuring attenuation.

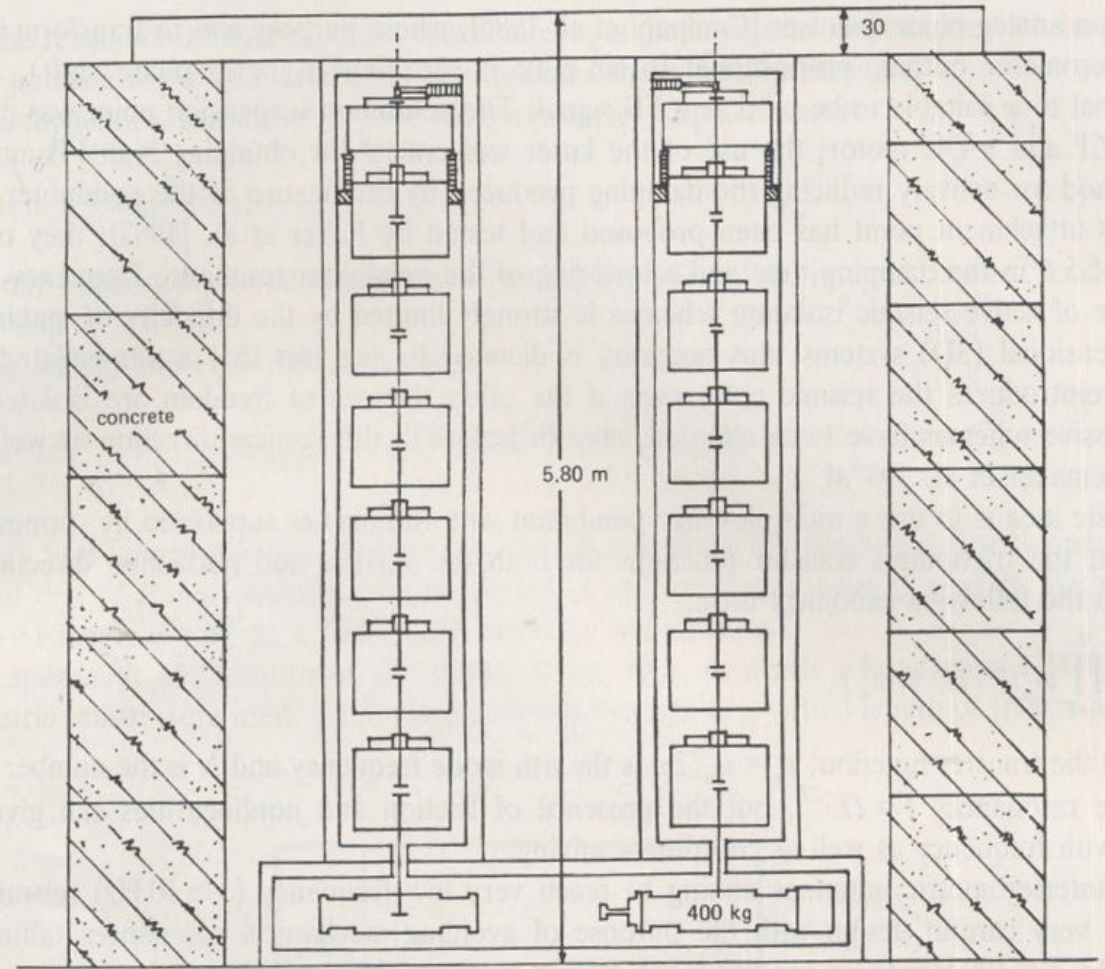
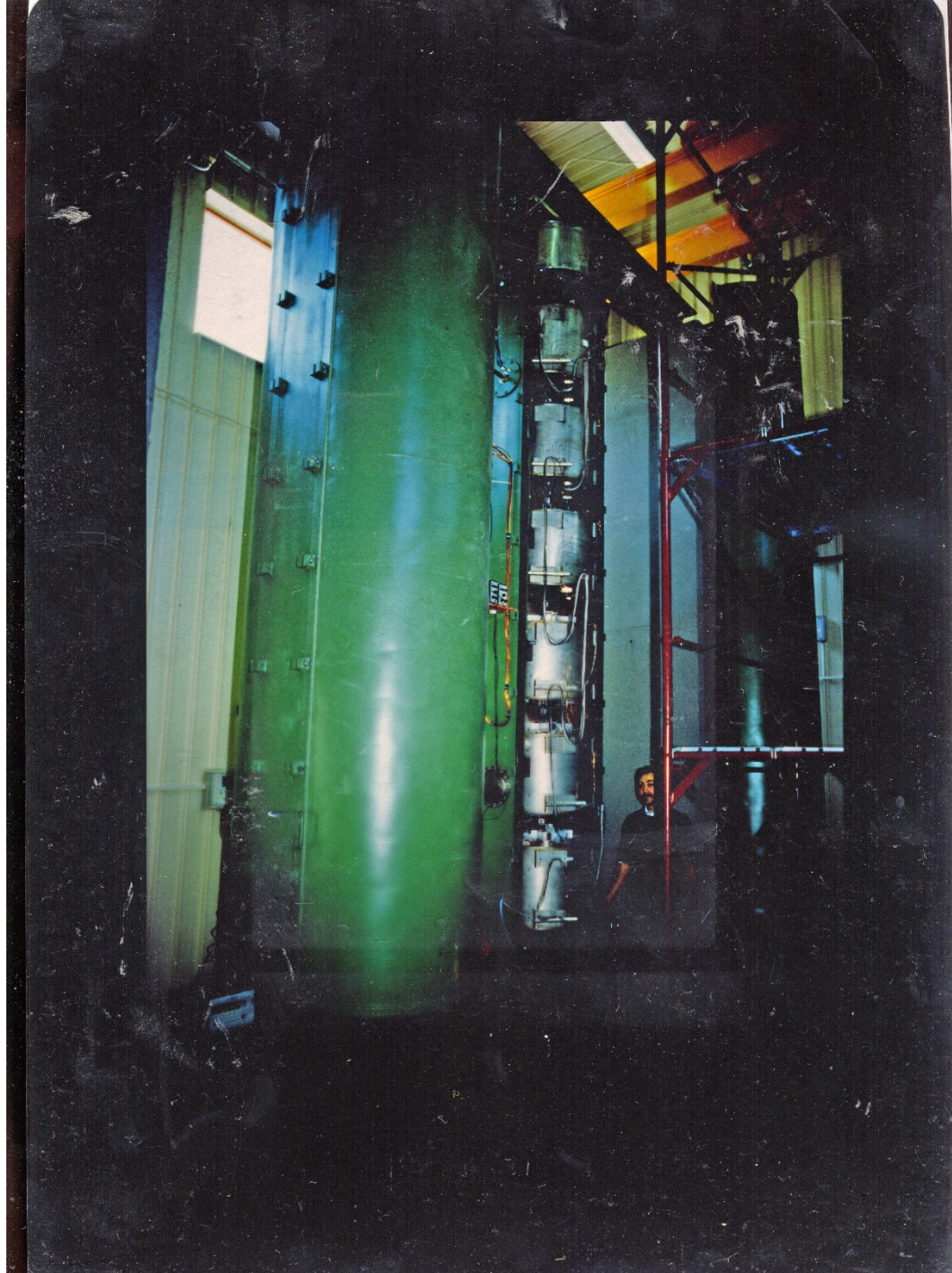

Fig. 11.4. Schematic diagram of the seismic noise attenuator (from Del Fabbro et al. [1988b]). The two attenuators, composed of a 7-fold three-dimensional harmonic oscillator, are able to give isolation in the vertical direction as well. The 400 kg test masses contained in the vacuum chamber are also shown. This device is able to attenuate the seismic noise in the vertical direction by a factor of $\leq 2 \times 10^{-8}$ at 10 Hz.



A. Giazotto, *Interferometric detection of gravitational waves*

Fig. 11.7. The displacement spectrum of the 400 kg test mass of the apparatus shown in fig. 11.4 in the frequency interval $0 \leq \nu \leq 10$ Hz (from Del Fabbro et al. [1988c]). Despite the fact that the accelerometer sensitivity is maximal in the horizontal direction, many vertical normal mode peaks are visible; a 10^{-2} mixing vertical-horizontal was measured, showing the necessity to have the vertical isolation as good as the horizontal one.

But Gas Springs, even if the working principle was correct, were too unstable under temperature variations. For this reason we created a mechanical filter satisfying the following requirements:

- 1) Mechanical restoring force
- 2) Almost insensitive to temperature variations
- 3) No creep
- 4) High momentum of inertia according to the three rotation axis

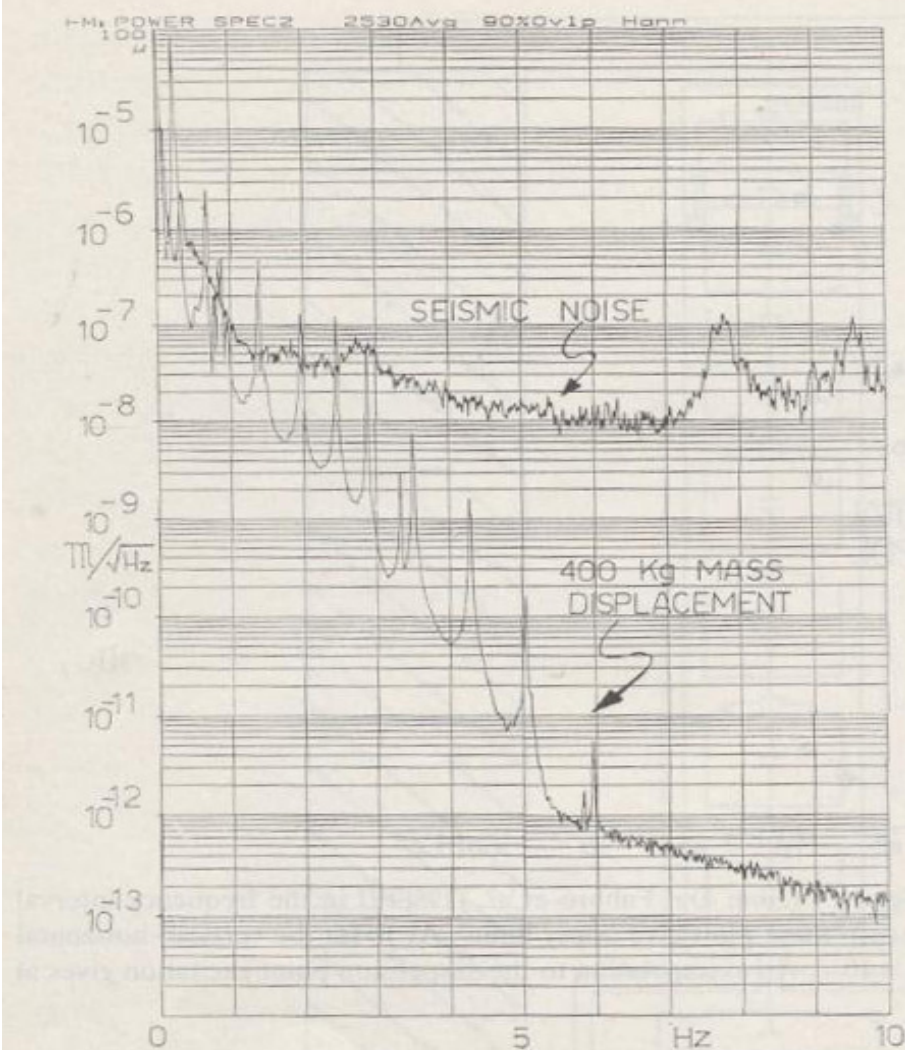
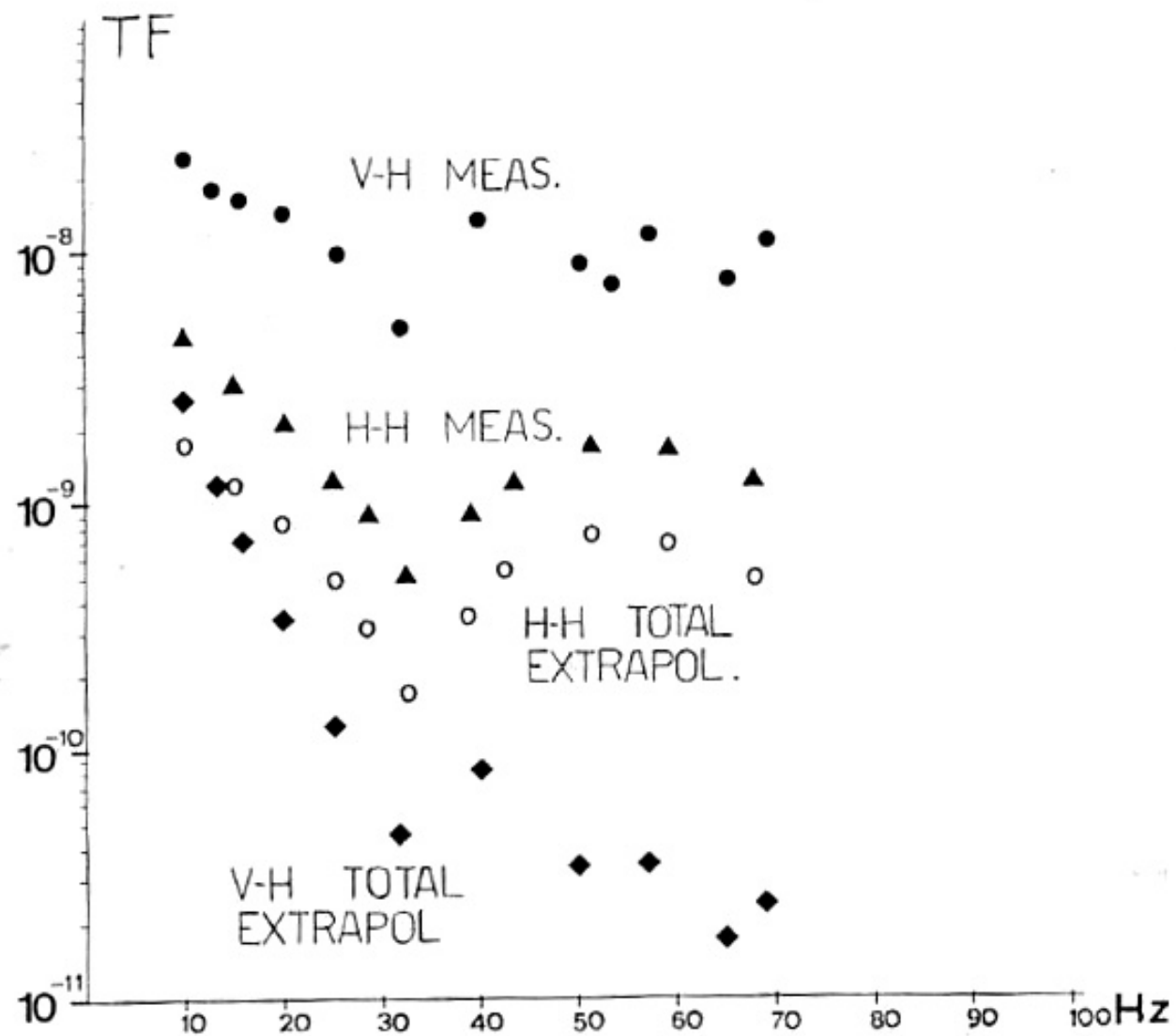
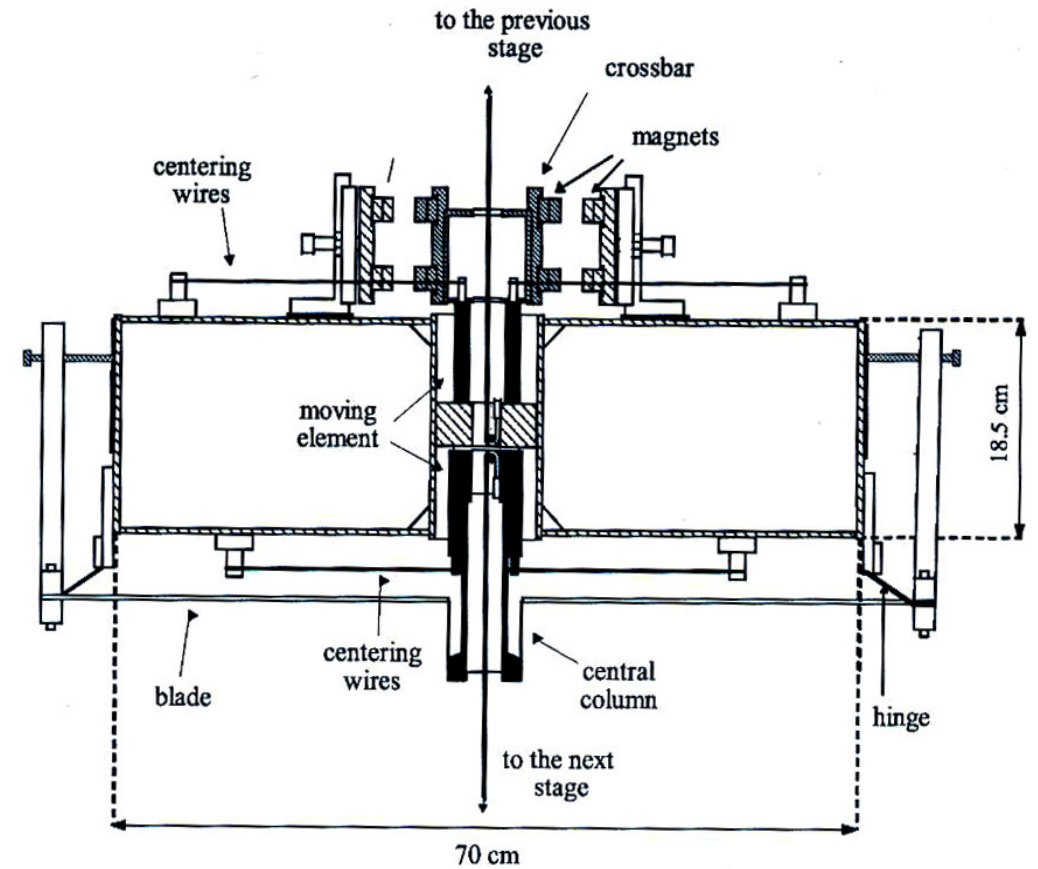

Figure 2: Drawing of a mechanical seismic filter. All the main components are indicated

- 5) Extremely low self vertical frequency, down to 100 mHz, by using magnetic antispring

TUNABLE MAGNETIC ANTISPRING

$K=3000 \text{ N/m}$
 $1,5 \text{ Hz}$

150 mm

**With Magnetic
Antispring** $K=30 \text{ N/m}$
 $0,15 \text{ Hz}$

50 Kg

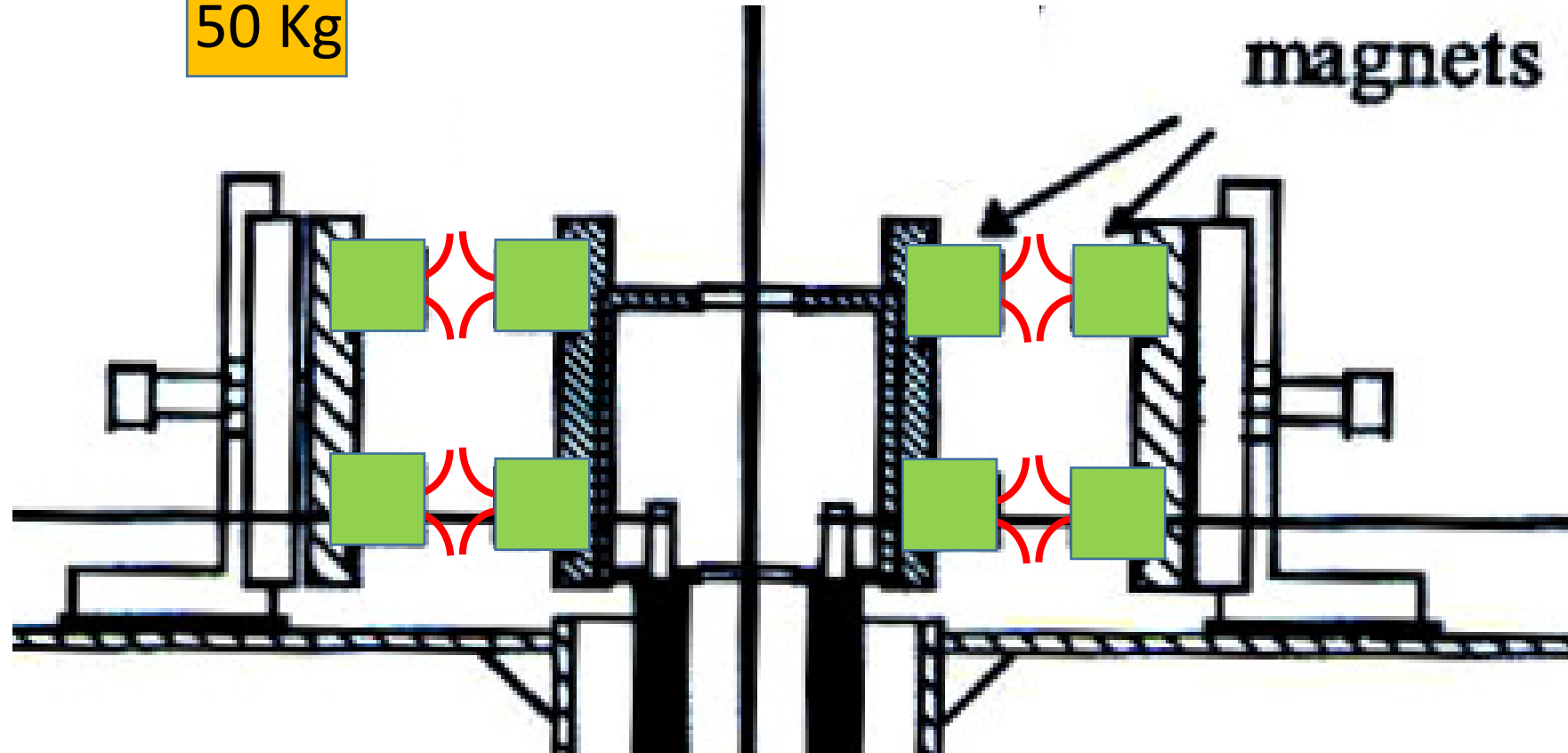
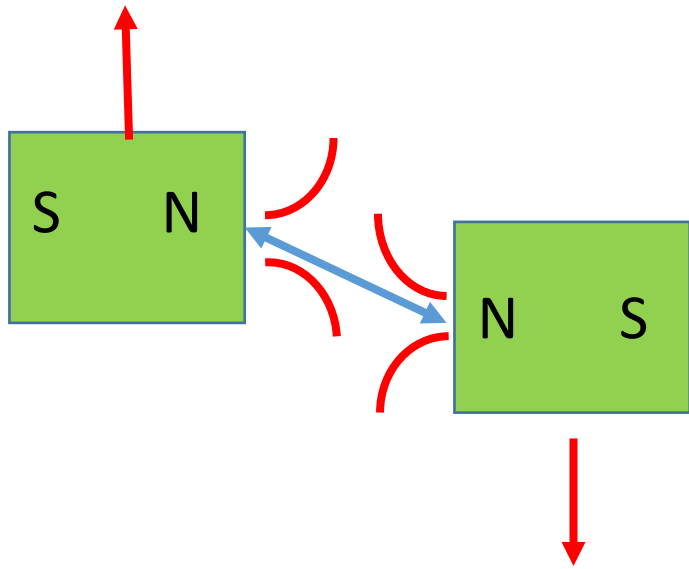

For displacing
suspended
Mirrors it was
necessary an
Inverted
Pendulum
inertially
controlled

INVERTED PENDULUM

Extremely
small
noiseless
forces could
displace the
Mirror

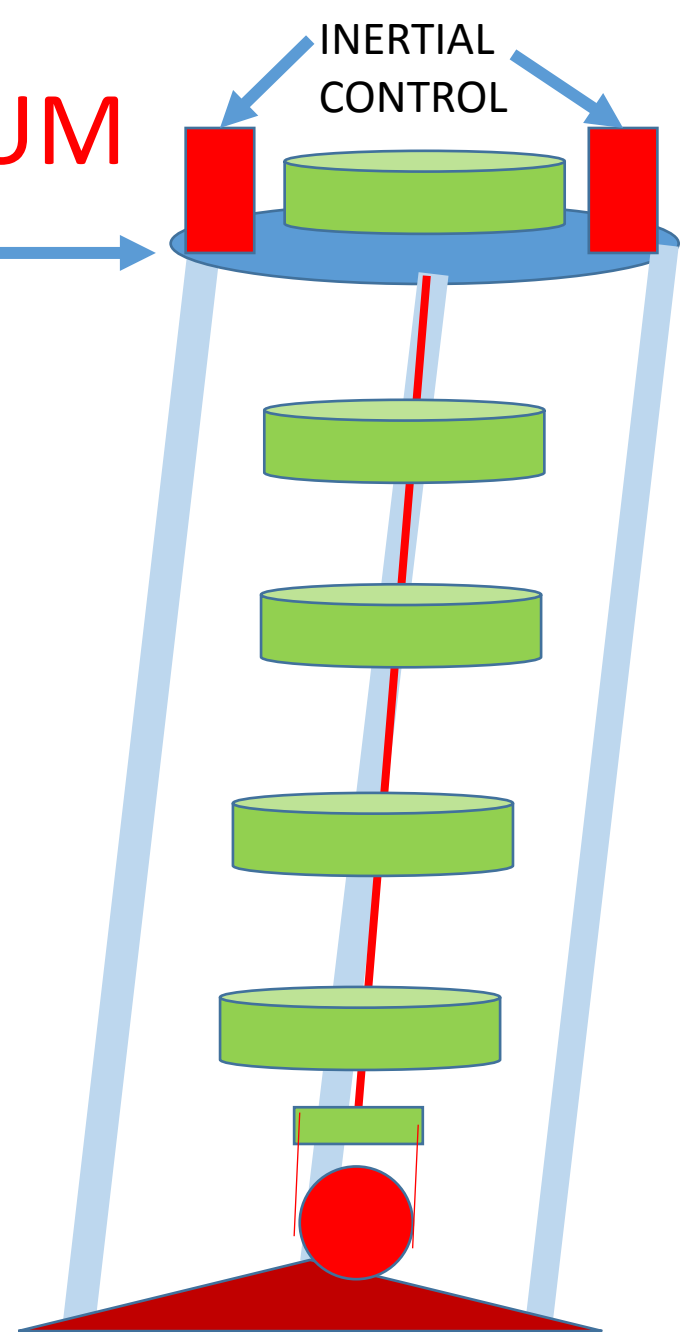



With Magnetic Antisprings and Inverted Pendulum everything changed, we were able to create an exceptional module performing in an outstanding way. This was the first Superattenuator, still working today.

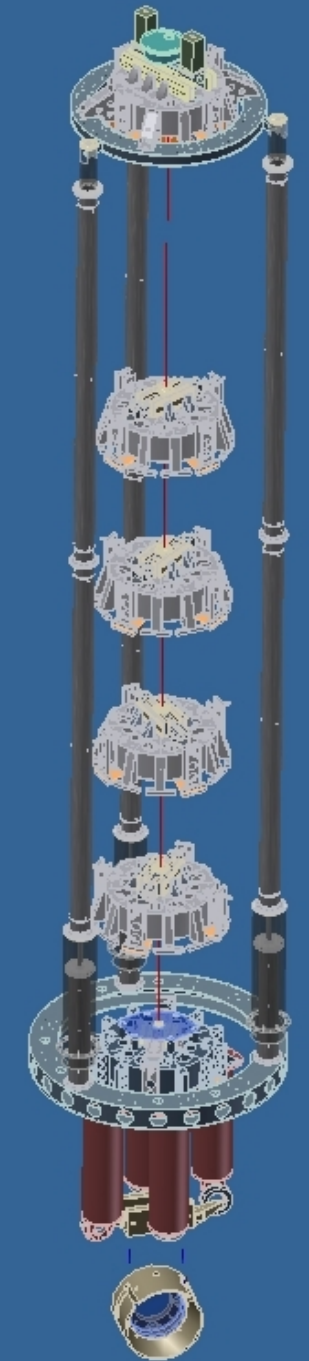
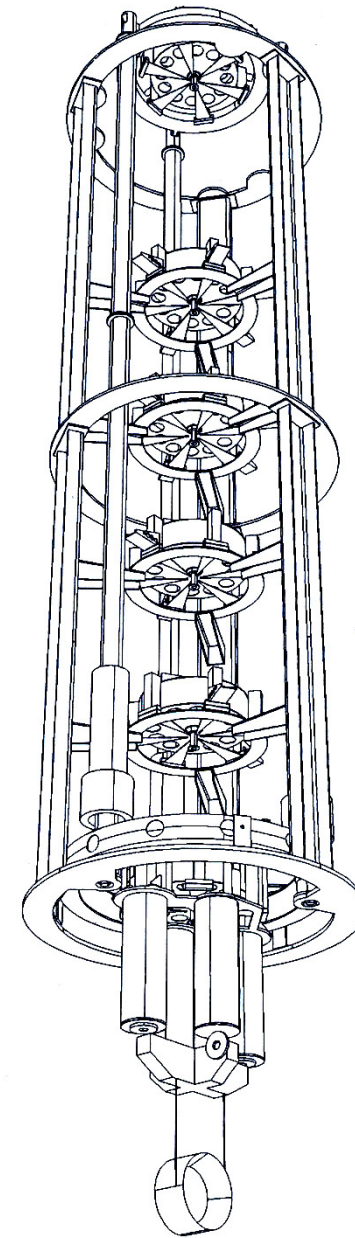
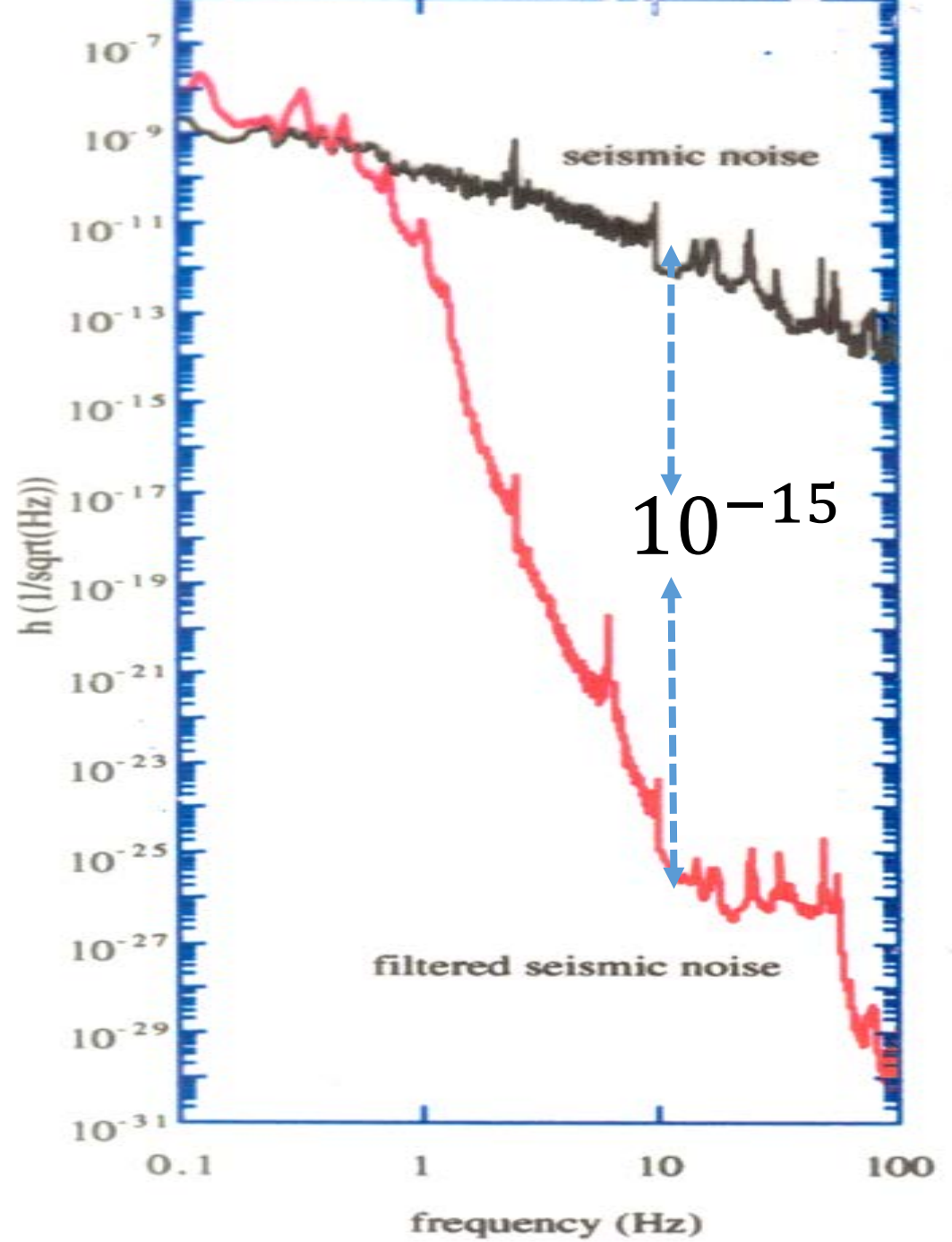
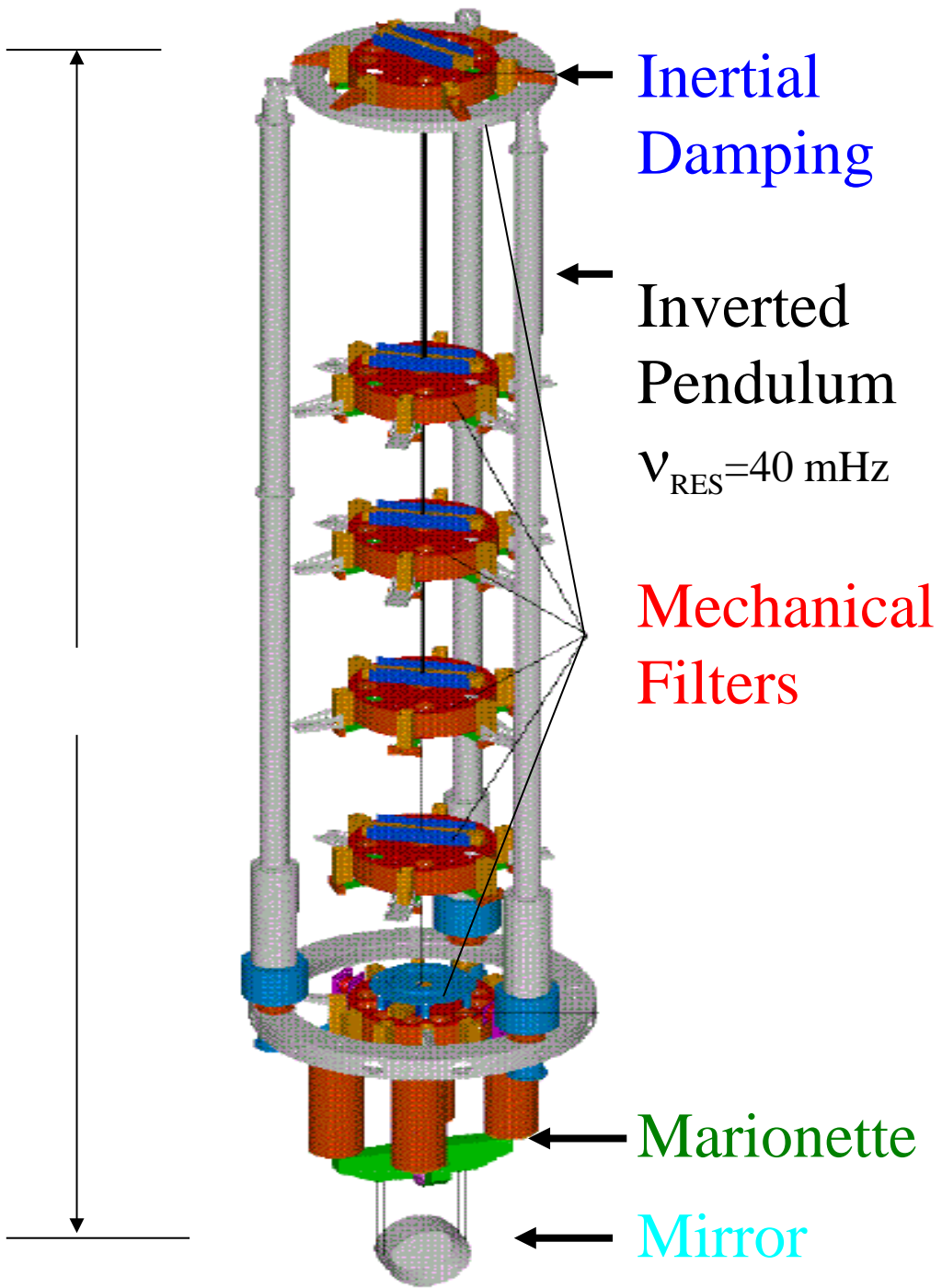
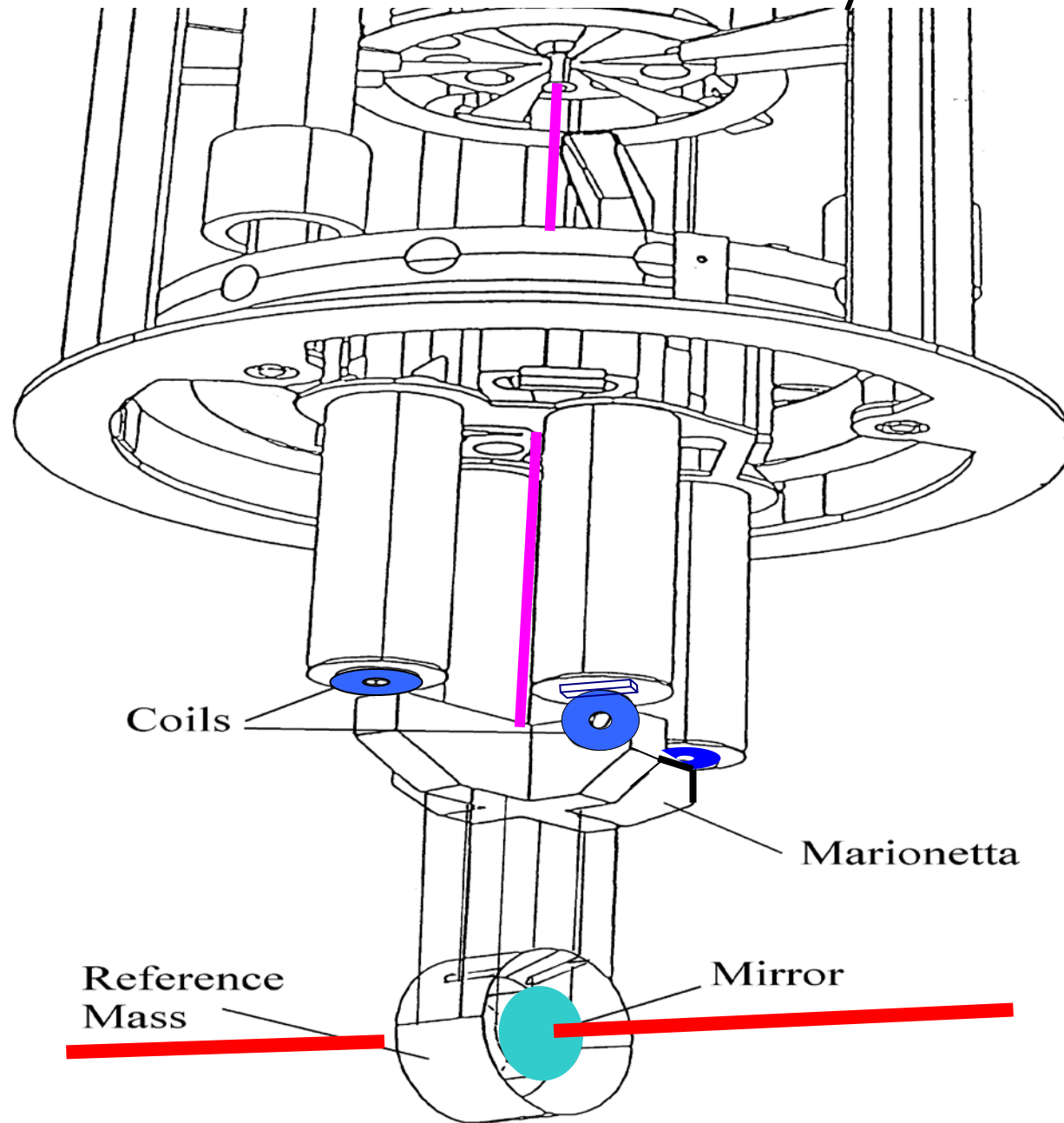

Figure 1: View of a long Superattenuator chain.



Filter 7-Mirror-Marionette System



Seismic Noise versus other Noise Sources

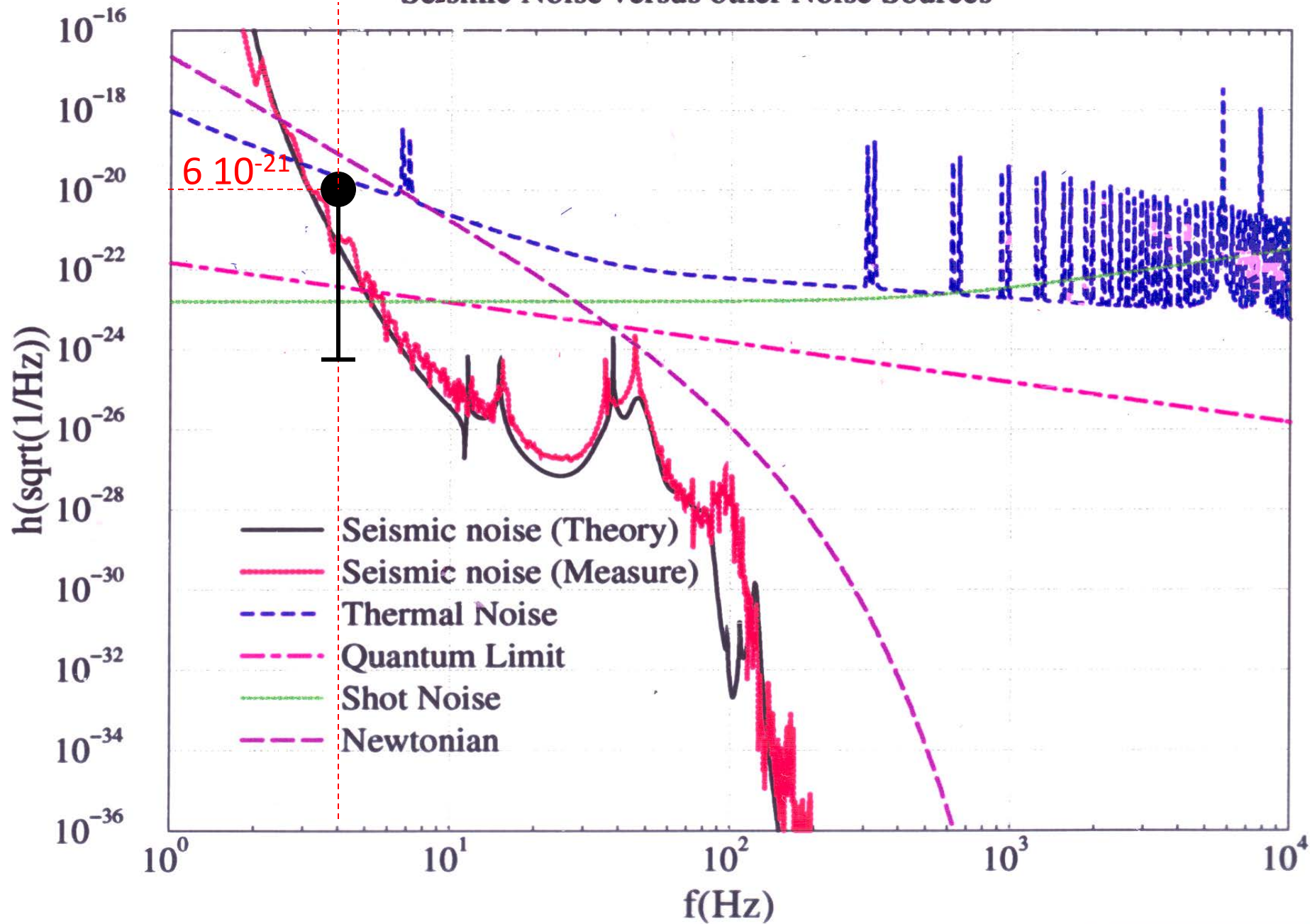

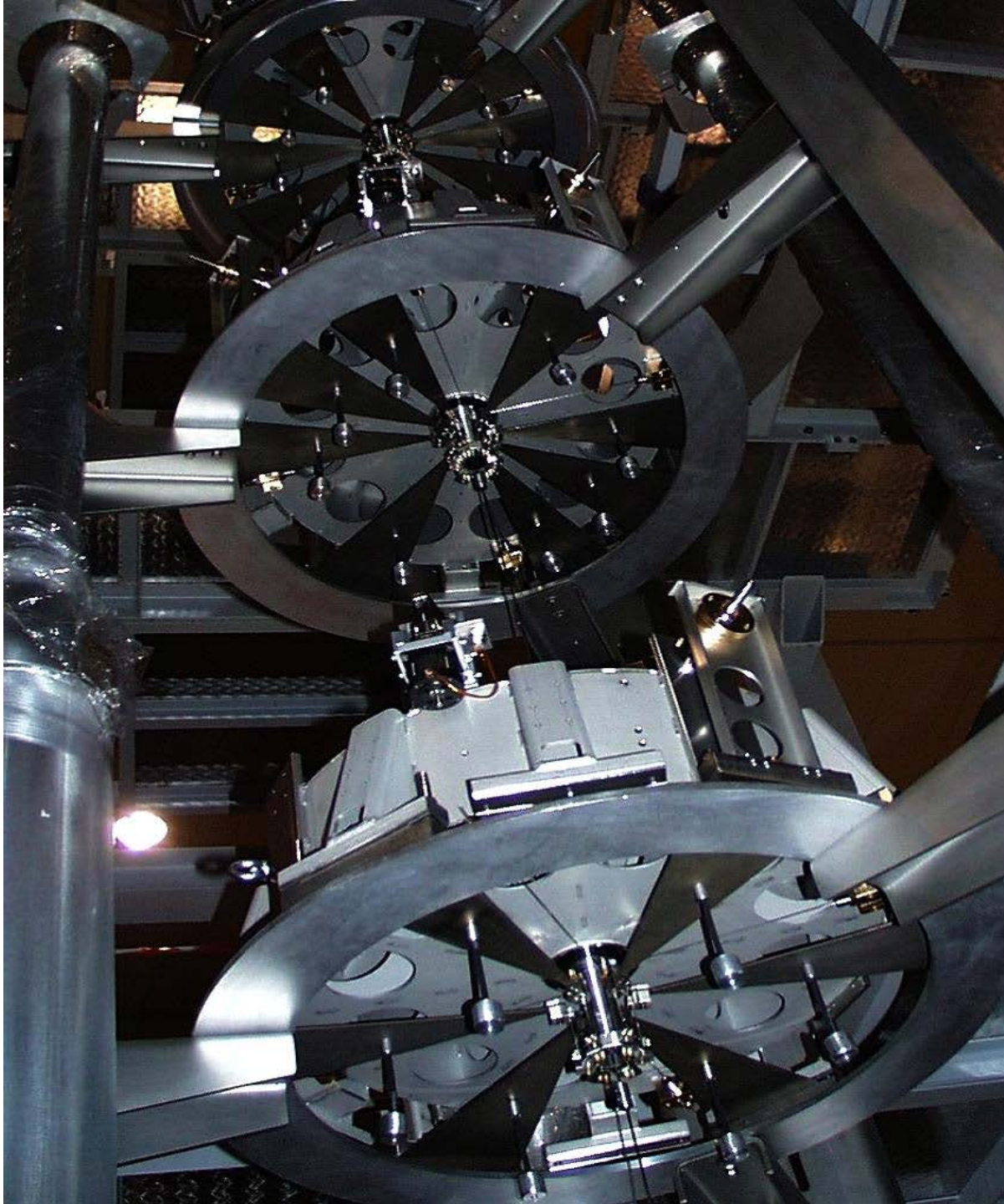







With these results in hand we were able to start a proposition to INFN and to CNRS for the construction of a 3 km ITF detector having also low frequency band to 10 HZ.

12 Maggio 1987
INFN PI/AE 87/1

Proposta di

**Antenna interferometrica a grande base per la
ricerca di Onde Gravitazionali**

Laboratori INFN Pisa e Università' di Pisa:

Carlo BRADASCHIA
Raffaele DEL FABBRO
Angela DI VIRGILIO
Adalberto GIAZOTTO
Hans KAUTZKY
Vinicio MONTELATICI
Diego PASSUELLO

Università' di Napoli

Fabrizio BARONE
Riccardo BRUZZESE
Antonello CUTOLO
Luciano DI FIORE (INFN)
Massimo LANDINI
Maurizio LONGO
Leopoldo MILANO
Salvatore SOLIMENO

CNR Frascati

Franco BORDONI
Franco FULIGNI
Valerio IAFOLLA

Università' di Salerno

Innocenzo PINTO

Gravitation et cosmologie Relativiste (Orsay-Paris)
CNRS-Univ. Pierre et Marie Curie

J.L. BOULANGER
Alain BRILLET
Oliver CREGUT
C. Nary MAN
Alain MARRAUD
David SHOEMAKER
Philippe TOURRENC
Jean-Yves VINET



UNIVERSITÀ DEGLI STUDI DI PISA
DIPARTIMENTO DI FISICA



Istituto Nazionale di Fisica Nucleare
Sezione di Pisa

October 18, 1988

INFN PI/AE 88/10

The Virgo Project: a Progress Report

C.N. Man, A. Brillet, O. Cregut, A. Marraud, D. Shoemaker,
J.Y. Vinet

Groupe de Recherches sur les Ondes de Gravitation
Laboratoire de Gravitation et Cosmologie Relativistes
Laboratoire de l'Horloge Atomique
Bat 104 _ Universite Paris-Sud _ 91405 Orsay FRANCE

J.L. Boulanger

Laboratoire de Gravitation et Cosmologie Relativistes
11 rue Pierre et Marie Curie _ 75235 Paris Cedex 05

C. Bradaschia, R. Del Fabbro, A. Di Virgilio, A. Giazotto,
H. Kautzky, V. Montelatici, D. Passuello

Istituto Nazionale di Fisica Nucleare, San Piero a Grado, 56100 Pisa,
Italia

Proceedings of the FIFTH MARCEL GROSSMANN Meeting, Perth, Western
Australia, 8-13 August 1988



UNIVERSITÀ DEGLI STUDI DI PISA
DIPARTIMENTO DI FISICA



Istituto Nazionale di Fisica Nucleare
Sezione di Pisa

ACCORD
concernant la Réalisation de
l'Antenne de Détection
des Ondes Gravitationnelles
VIRGO

Le Centre national de la Recherche scientifique, Etablissement Public à caractère Scientifique et Technologique - ci-après désigné par les initiales CNRS et dont le siège social est sis 3, rue Michel-Ange, F75794 Paris Cedex 16, représenté par son Directeur Général, M. François Kourilsky,

et

l'Istituto Nazionale di Fisica Nucleare, institut publique pour la recherche scientifique - ci-après désigné par les initiales INFN et dont le siège social est sis via Enrico Fermi 40, I 00044 Frascati, représenté par son Président, M. Luciano Maiani,

ci-après désignés les Parties ;

CONSIDÉRANT que la détection des ondes gravitationnelles offrira

dans le domaine de la physique fondamentale

- une preuve directe de l'existence des ondes gravitationnelles ;
- un mode d'investigation des caractéristiques tensorielles du champ gravitationnel ;

dans le domaine de l'astronomie et de l'astrophysique

- un nouveau moyen d'observation des objets lointains, en sus des ondes électromagnétiques et des neutrinos ; il s'agira d'un instrument unique pour la détection des phénomènes très énergétiques tels que l'effondrement des supernovae et des binaires serrées ;

CONSIDÉRANT qu'une collaboration dans ce domaine existe déjà depuis de nombreuses années entre scientifiques français et italiens ;

conséquence il présente Accordo sarà modificato tramite una clausola aggiuntiva.

ARTICOLO 14 - CONTROVERSIE

Le Parti risolveranno amichevolmente ogni controversia che potrebbe risultare dalla interpretazione o dalla applicazione del presente Accordo.

ARTICOLO 15 - SCALA DEI TEMPI

La data di acquisizione del sito costituisce il tempo zero della scala dei tempi previsti per la realizzazione del progetto (Allegato B). Nel frattempo la progettazione e la realizzazione di prototipi di sottosistemi nonché altre attività definite dal Consiglio VIRGO, sono o potranno essere condotte senza relazione temporale con l'acquisizione del sito.

ARTICOLO 16 - ENTRATA IN VIGORE

Il presente Accordo entrerà in vigore dopo essere stato approvato dalle Autorità competenti delle Parti.

ARTICOLO 17 - DURATA

A meno che decidano di comune accordo di mettere fine alla loro collaborazione, le Parti si impegnano a parlarla avanti, oltre alla fase di costruzione, per una durata minima di gestione di cinque anni, conformemente a quanto previsto dall'articolo 1. del presente Accordo.

ARTICOLO 18 - DISPOSIZIONI FINALI

Il presente Accordo é redatto in quattro esemplari originali, due in versione francese e due in versione italiana, entrambe facenti ugualmente fede.

..... Pza .. 27 Jun 1994



Per il CNRS

François KOURILSKY
Direttore Generale



Per l'INFN

Prof. Luciano MAIANI
Presidente