

The LHCb Upgrade

Monica Pepe Altarelli (CERN)
on behalf of the LHCb collaboration

XXVI Giornate Sui Rivelatori - Scuola F. Bonaudi
13-17 Febbraio, Cogne

Outline

- Introduction, context and motivation for the current experiment
- The LHCb detector (main features, trigger, operation, limitations)
- The upgraded detector (motivation and main features)
- Some ideas about the ...far future

Many thanks to my colleagues for (un)knowingly helping me!

The LHCb collaboration b stands for beauty

~ 700 authors from 71 institutes in 16 countries
> 350 publications, some of which with very large impact



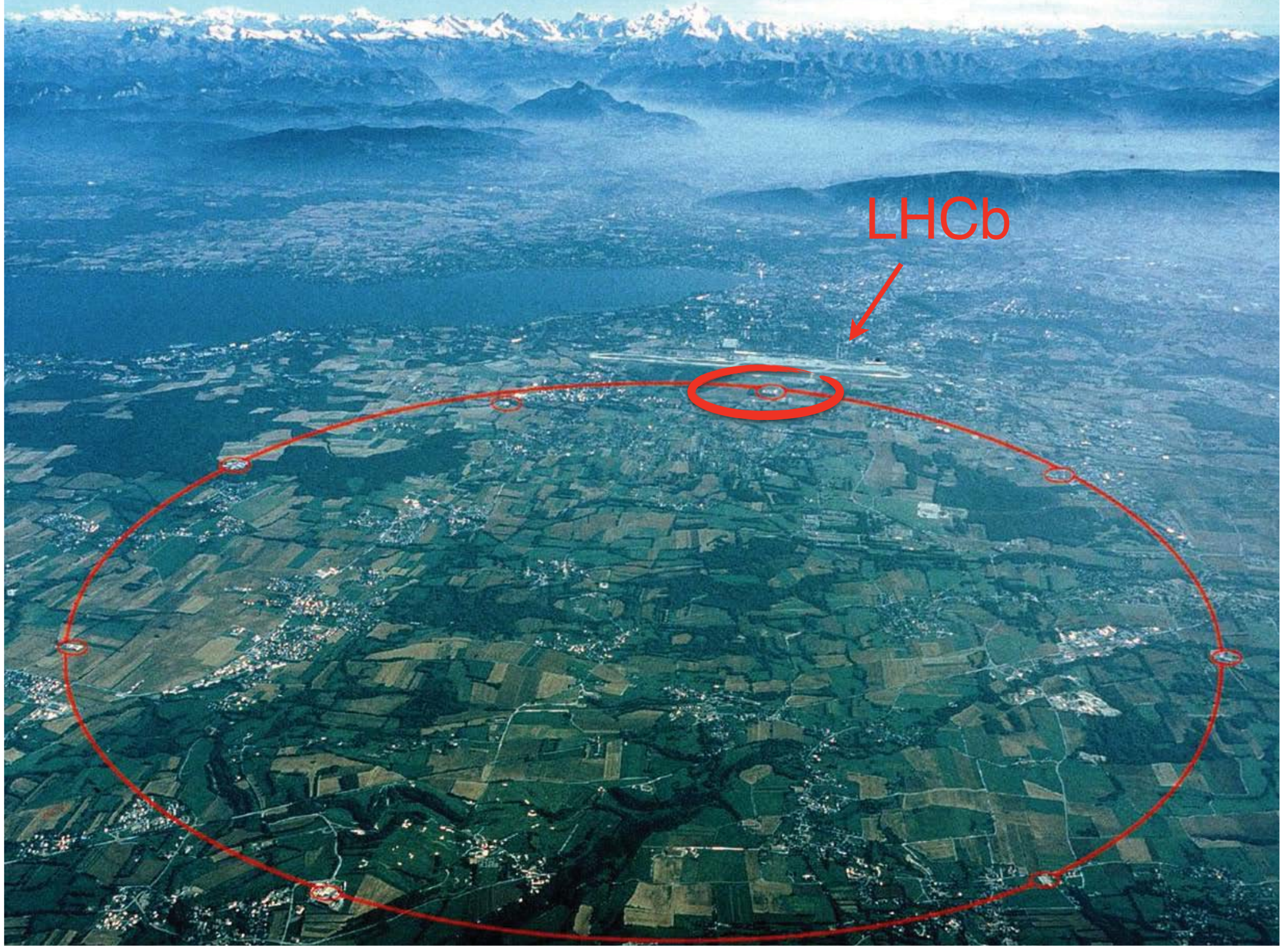

LHCb

b: a third generation quark

- By now we know of six quark 'flavours'

Q is the electric charge, in units of proton charge

$$Q=2/3$$

up



charm

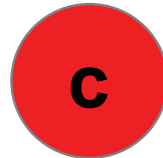

top

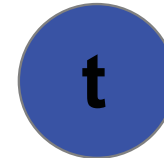

mass (Gev/c²) 0.0025

1.3

173

down



strange

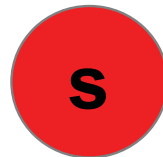

beauty or bottom

$$Q=-1/3$$

mass (Gev/c²) 0.0048

0.1

4.5

- Six flavours in three "families" or "generations" of increasing mass

Heavy-quark composites

Mesons with c

$$\begin{aligned}
 D^+ & : c \bar{d} \\
 D^0 & : c \bar{u} \\
 D_S & : c \bar{s} \dots \\
 J/\Psi & : c \bar{c}
 \end{aligned}$$

Mesons with b

$$\begin{aligned}
 B^+ & : \bar{b} u \\
 B^0 & : \bar{b} d \\
 B_S & : \bar{b} s \dots \\
 Y & : \bar{b} b
 \end{aligned}$$

- Baryons (qqq)
- Heavy quarks are unstable and decay via weak interactions to lighter quarks
- The probability of the transition from flavour i to flavour j is $\sim |V_{ij}|^2$
- V_{ij} is a matrix element for quark-flavour mixing (Cabibbo-Kobayashi-Maskawa CKM matrix V_{CKM})

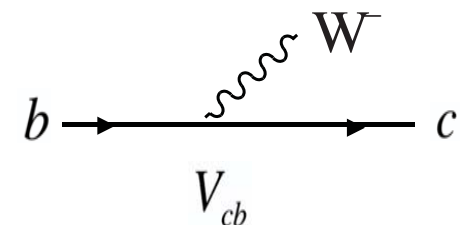

Why b?

- The heaviest quark that binds in hadrons
- Lifetime long enough for experimental detection
- While the t quark lifetime is too short, the b and c quarks live long enough so that we can study their production and decay sequence in detail:

- $\tau_{\text{beauty}} \sim 1.5 \cdot 10^{-12} \text{ s}$
- $\tau_{\text{charm}} \sim 10^{-12} \text{ s}$
- $\tau_{\text{top}} \sim 5 \cdot 10^{-25} \text{ s}$

$$\tau \sim 1/(m^5 |V_{ij}|^2)$$

- Many decay channels: a vast laboratory
- Heavy mass \rightarrow more theoretically accessible

Lifetime long enough for experimental detection

- $\tau_{\text{beauty}} \sim 1.5 \cdot 10^{-12} \text{ s}$ $\tau \sim 1/(m^5 |V_{cb}|^2)$

- $D = \beta \gamma c \tau$

- @ LHC :

- ★ $\beta = v/c \sim 1$

- ★ $\gamma = E/mc^2 \sim 20$ ($E : b$ energy)

- $D = 20 \cdot 3 \cdot 10^{10} \cdot 1.5 \cdot 10^{-12} \sim 1 \text{ cm}$

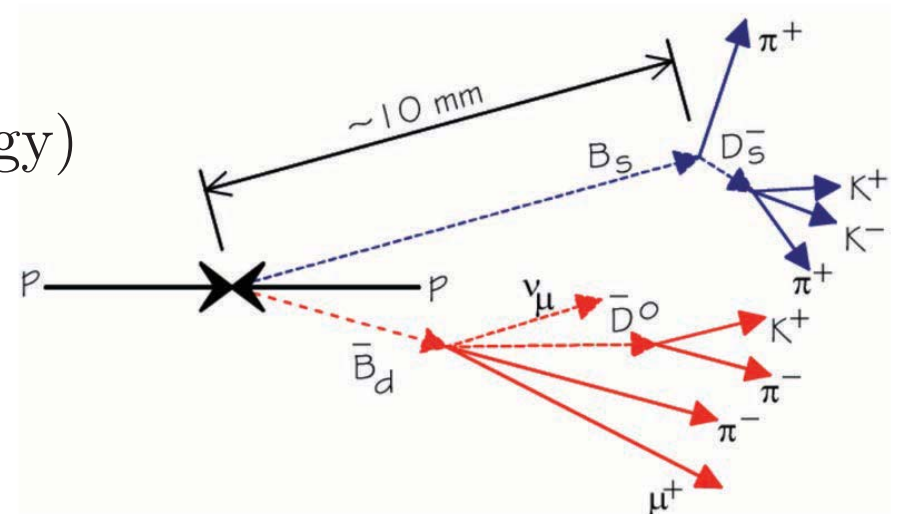

Why b? (II)

- Sizeable CP violation (CPV) expected in many decay
 - CP symmetry: matter-antimatter symmetry
 - C = charge conjugation (swapping particles & antiparticles)
 - P = parity (spatial inversion, like reflection in a mirror)
- Large CPV effects expected in processes that involve quarks from all three generations (quark mixing cannot violate CP in a world with only two families!)
 - 2008 Nobel prize to K&M: CPV requires the existence of at least three families

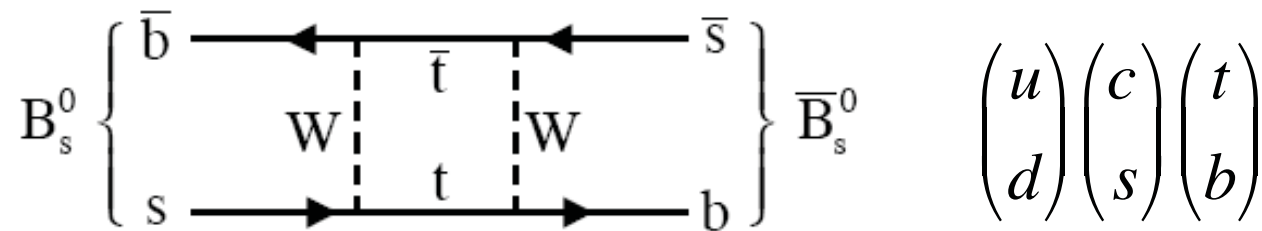

- Most TeV new physics contains new sources of CP and flavour violation
- The observed baryon asymmetry in the universe requires CPV beyond the SM
 - Not necessarily in flavour changing processes, nor necessarily in quark sector, it could originate from lepton sector

Why b? (III)

- Some rare decays can only proceed through loop diagrams, e.g. $B_{(s)} \rightarrow \mu^+ \mu^-$

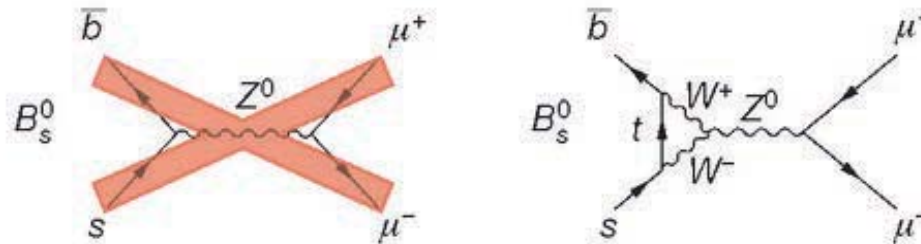

- $Z^0 \rightarrow bs$ vertex does not exist!

$$\mathcal{B}(B^0 \rightarrow \mu^+ \mu^-) = (1.06 \pm 0.09) \times 10^{-10}$$

$$\mathcal{B}(B_S^0 \rightarrow \mu^+ \mu^-) = (3.65 \pm 0.23) \times 10^{-9}$$

Bobeth et al.
[PRL 112 (2014) 101801]

- A new particle X , too heavy to be produced at the LHC, could give sizeable effects when exchanged in a loop, at the level of SM

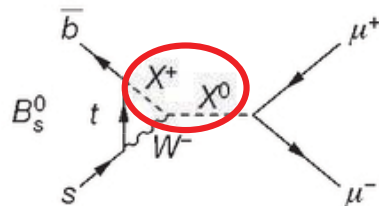

B decays: a window on NP at high scales

- **New particles in the 1-10 TeV LHC range** (there are reasons to believe they should exist!) **would produce visible signals in rare B decays unless the NP is highly non generic**
- **Bounds on the scale of NP (up to $\sim 10^5$ TeV) go well beyond the direct production capabilities of new particles at the LHC (\sim few TeV)**
- **In conclusion, precision studies of B decays offer a window on NP not accessible to direct production** (even if the space for TeV NP is clearly reduced after the results of the LHC at 7, 8 and 13 TeV)

The LHCb detector

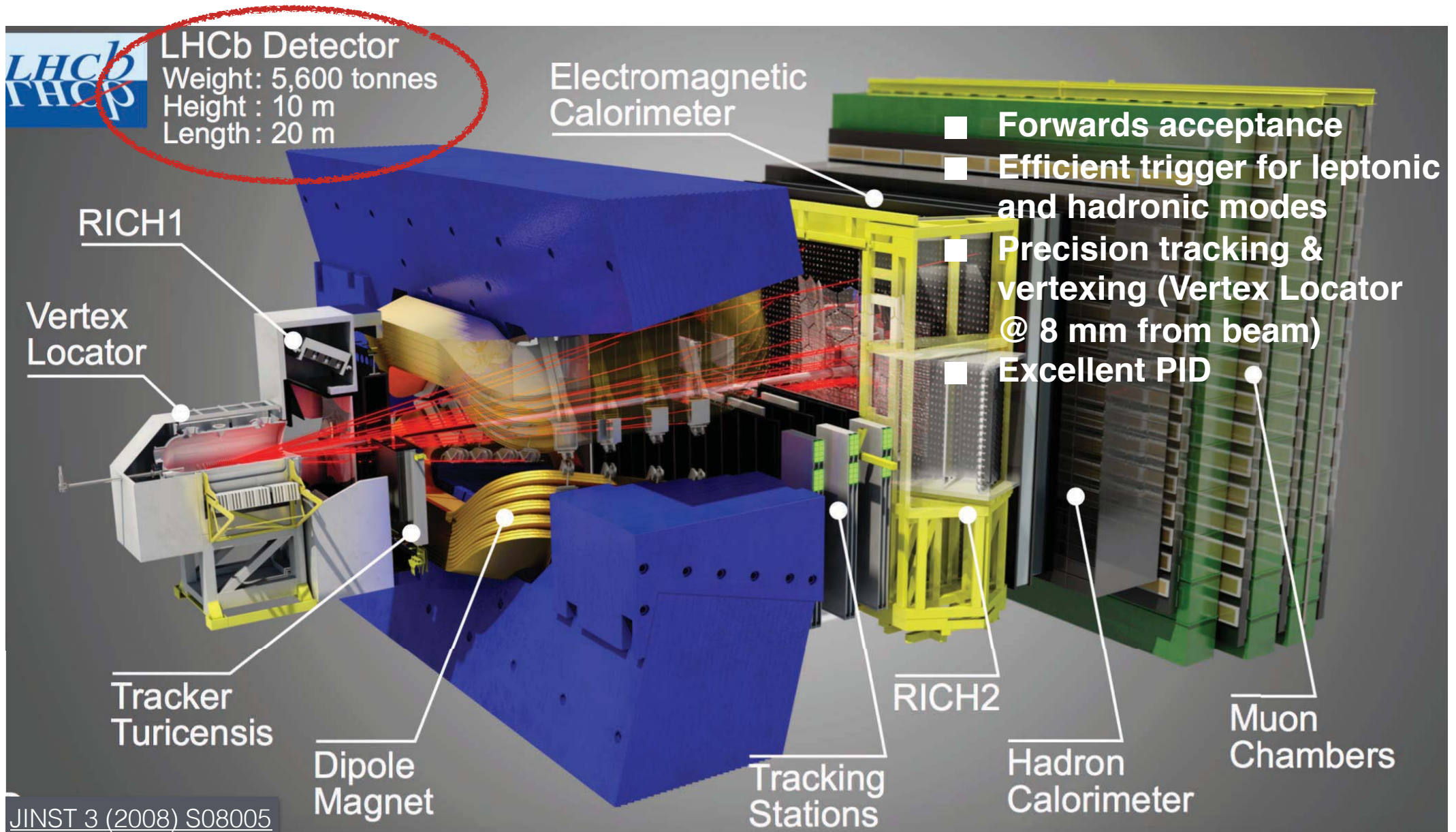

Why does LHCb look so different?

- The B mesons formed by the colliding proton beams (and the particles they decay into) stay close to the line of the beam pipe, and this is reflected in the design of the detector

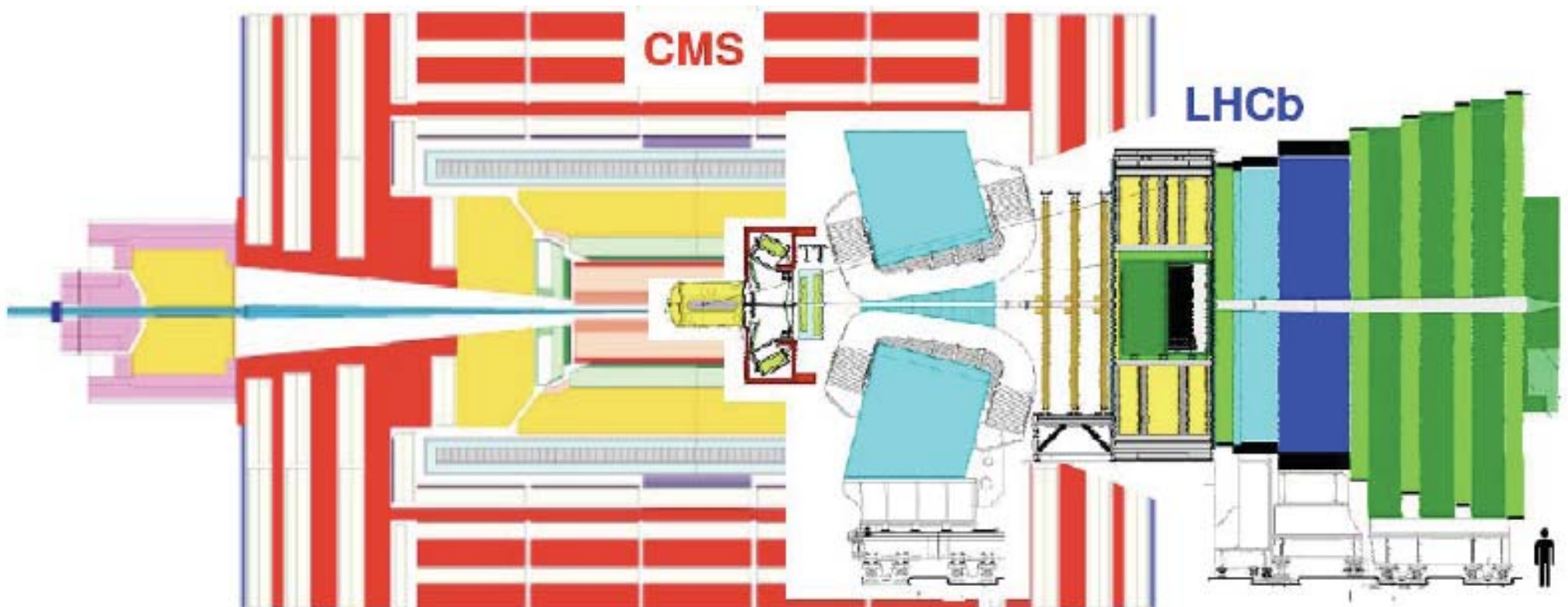
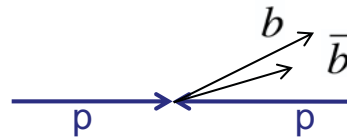

The real thing

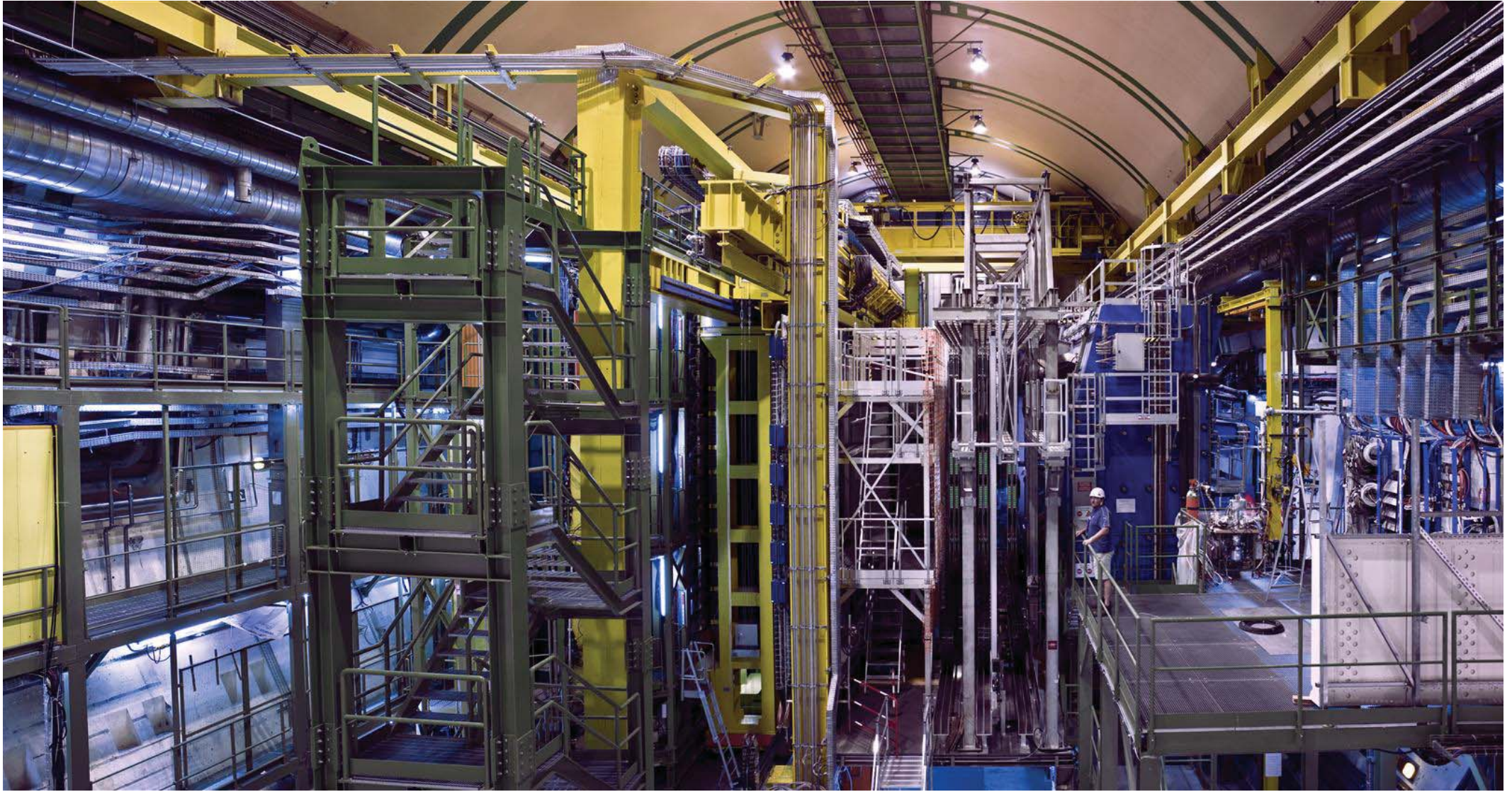

With components superimposed

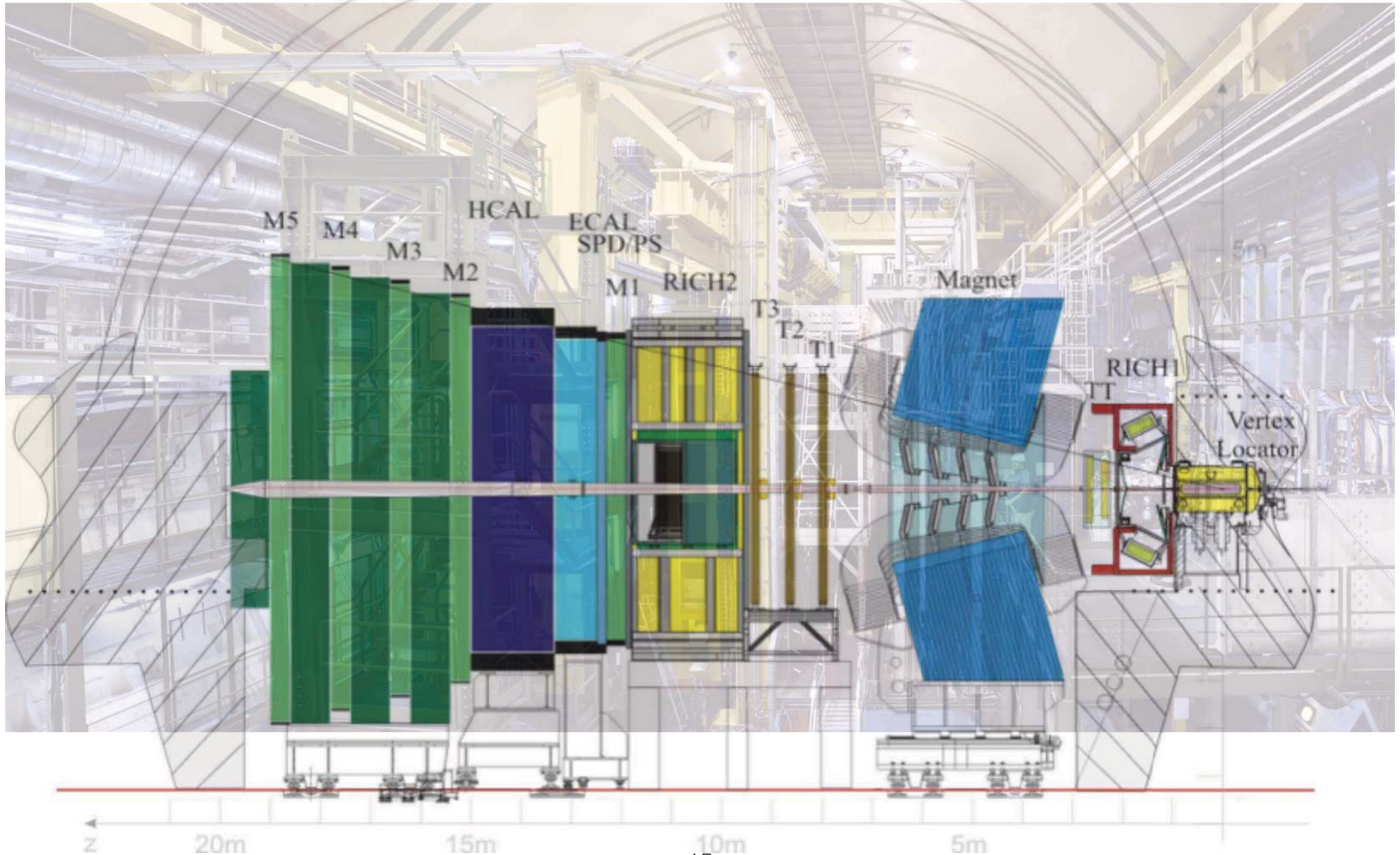

VErtex LOcator (VELO)

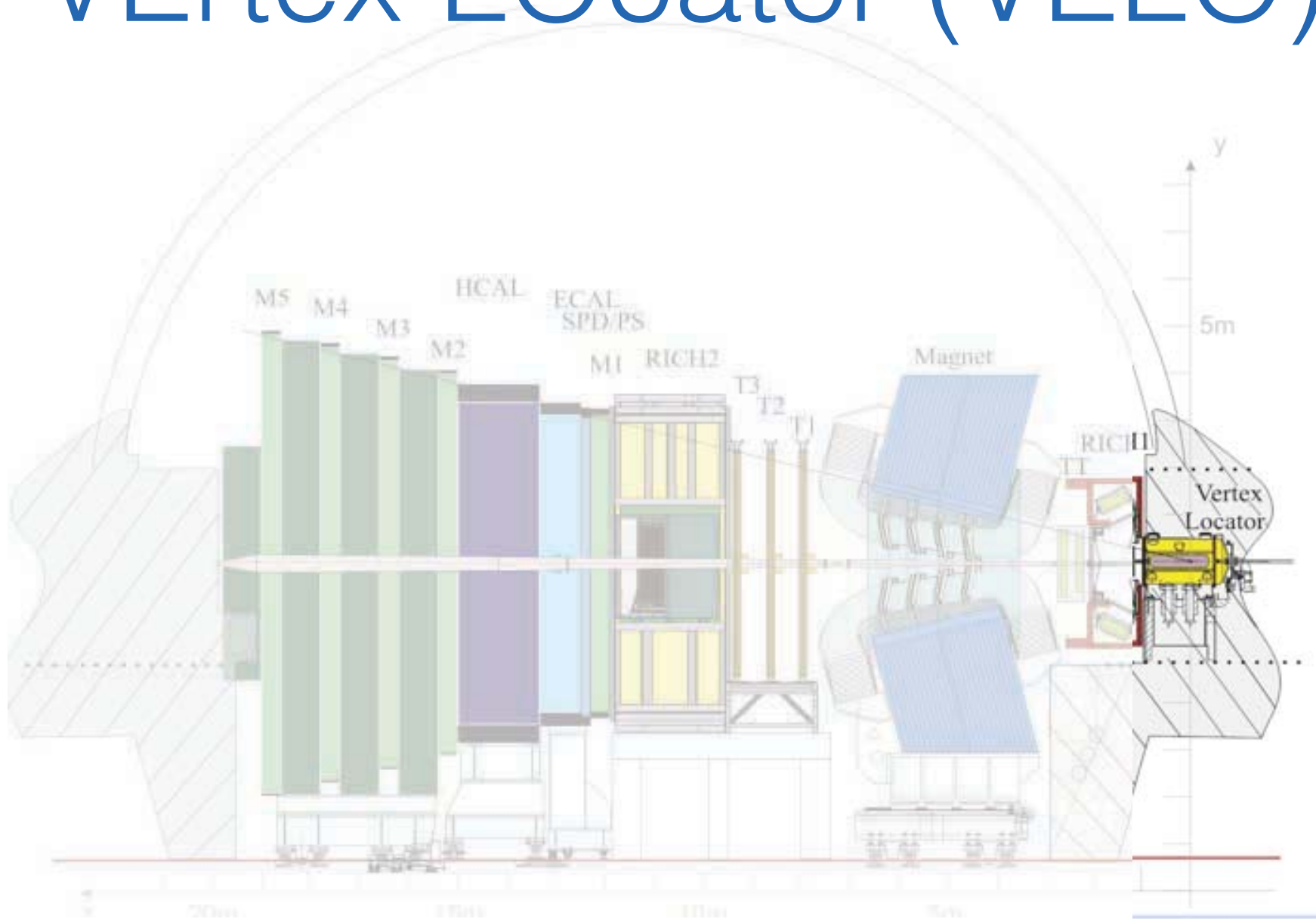

VELO

- A precise particle detector, which surrounds the pp collision point inside LHCb
- It is composed of 21 stations, each made of two silicon half disks with R- ϕ silicon strip sensors
- Retractable for safe operations outside of stable beam conditions

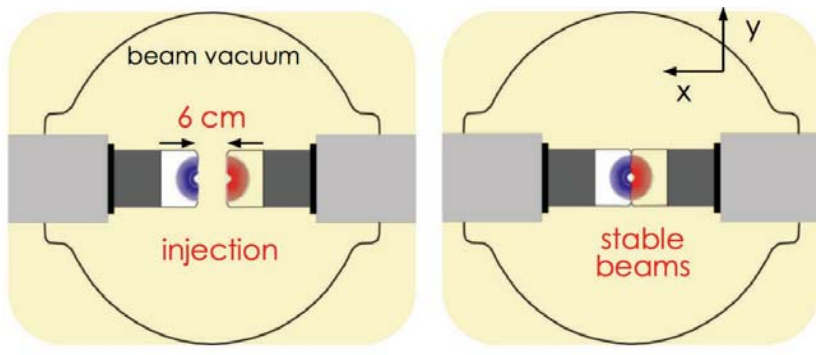

- Active area just 8.2 mm from beams
- Aluminium foil separates VELO detector vacuum from LHC vacuum and shields it from high-frequency fields of the LHC beams

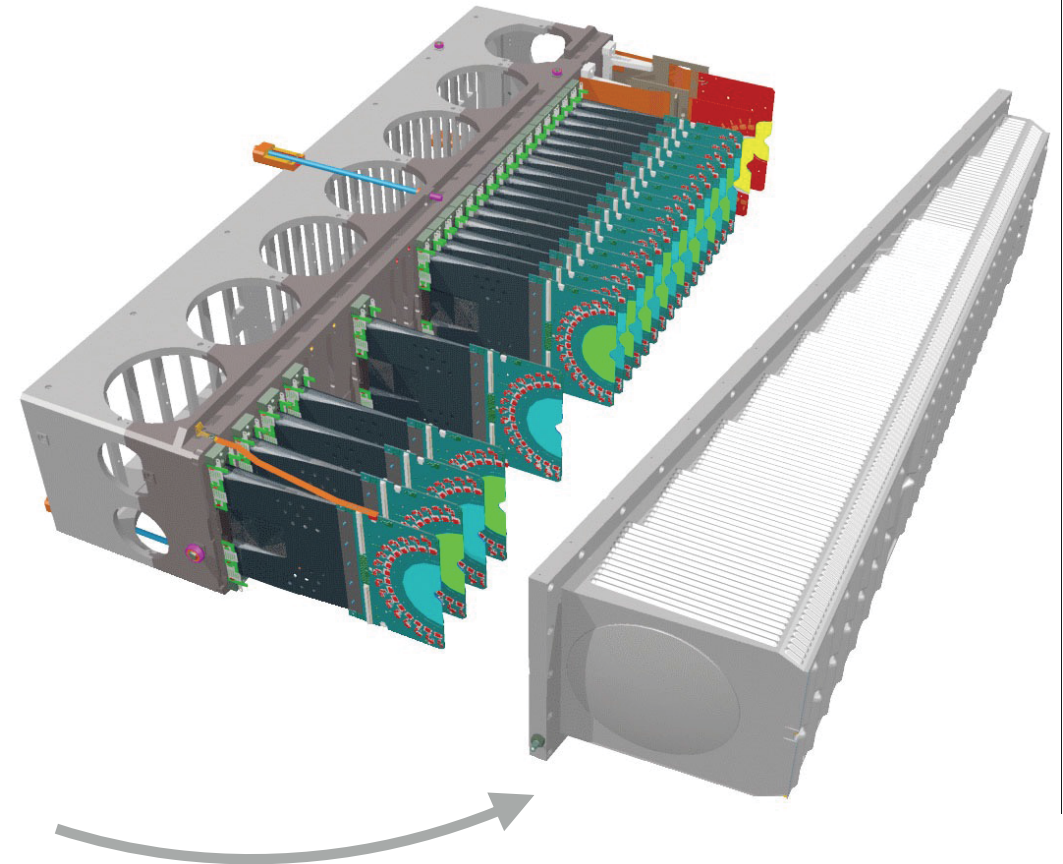

VELO

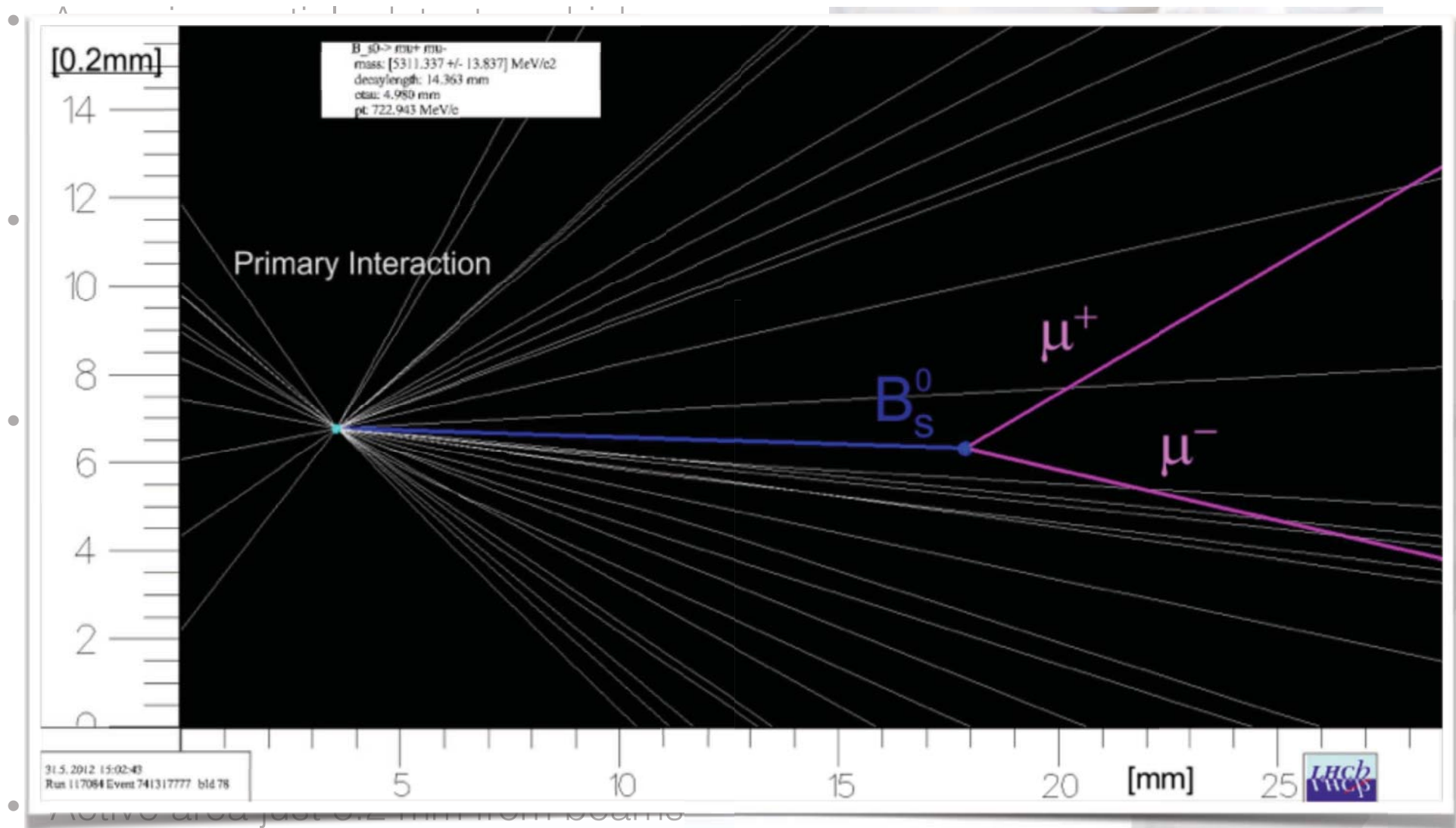

- Separate **A reconstructed B_s -hadron to $\mu^+ \mu^-$ decay vertex** aluminium foil

VELO key optimisation points

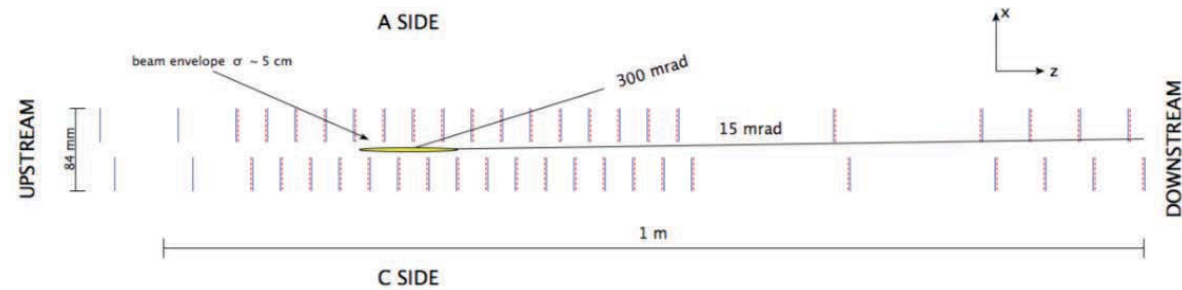

- **Angular coverage**

- Designed to cover the forward region such that all tracks inside nominal LHCb acceptance of 15-300 mrad cross at least three stations

- **Triggering**

- Reconstruction of primary vertex and secondary displaced vertex are a key ingredient of the high level trigger, which reduces the event rate from 1 MHz to few kHz

- **Cluster reconstruction**

- Paramount for track selection, efficient pattern recognition and fake track rejection

- **Vertex resolution**

- Most analyses rely on impact parameter (IP) cuts and secondary vertex (SV) reconstruction

- **Decay time resolution**

- Obtained from measurement of flight distance in VELO

VELO performance: Impact Parameter

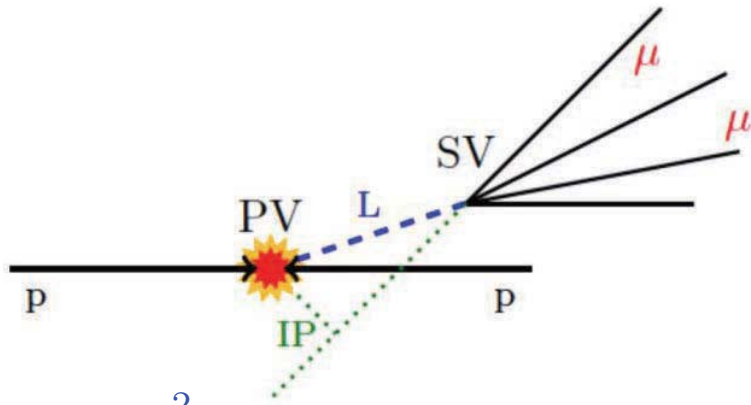

$$\sigma_{IP}^2 = \frac{r_1^2}{p_T^2} \sigma_{MS}^2(x/X_0) + \sigma_{extrap}^2(\sigma_1^2, \sigma_2^2)$$

- r_1 is radius of first measured point
- x/X_0 is fractional radiation length before second measured point
- σ_1 and σ_2 are measurement errors of first and second point

- IP resolution optimised by positioning sensors as close as possible to LHC beams, minimising material before first VELO hits, having small inter-strip pitch (from 40 to 100 μm)
- IP resolution $< 35 \mu\text{m}$ for $p_T > 1 \text{ GeV}/c$

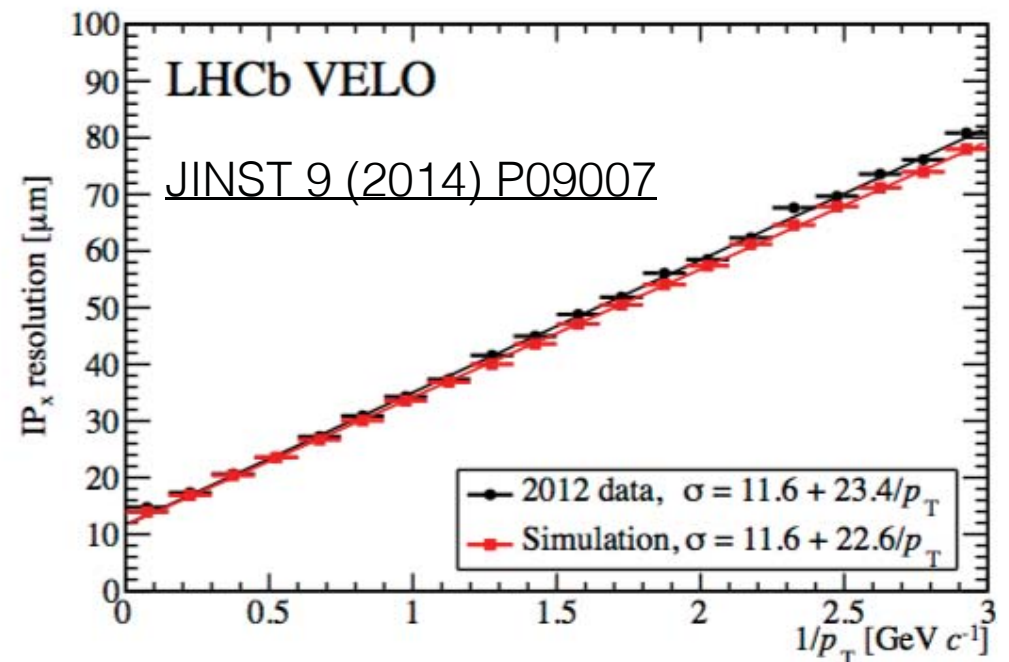

VELO performance: decay time

- Run1 decay time resolution ~ 50 fs
- Excellent decay time resolution essential to resolve fast $B_s^0 - \bar{B}_s^0$ oscillations : ~ 50 fs \ll 350 fs, oscillation period
- Precision measurement of $B_s^0 - \bar{B}_s^0$ oscillation frequency

$$t = ml/p$$

$$\sigma_t = \left(\frac{m}{p}\right)^2 \sigma_l^2 + \left(\frac{t}{p}\right)^2 \sigma_p^2$$

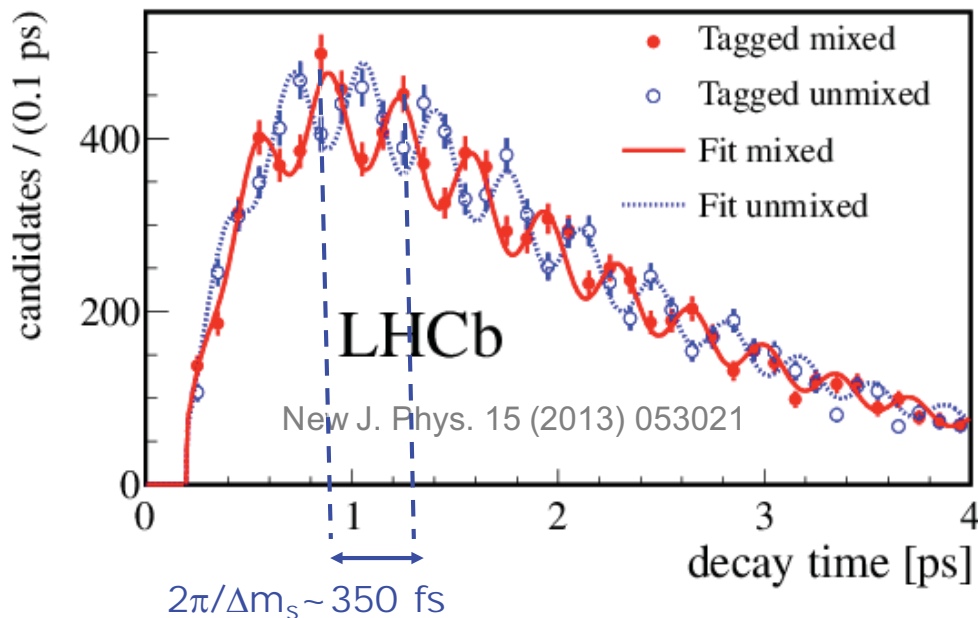
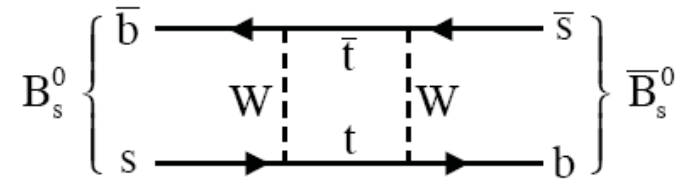

- Different flavour at decay and production
- Same flavour at decay and production

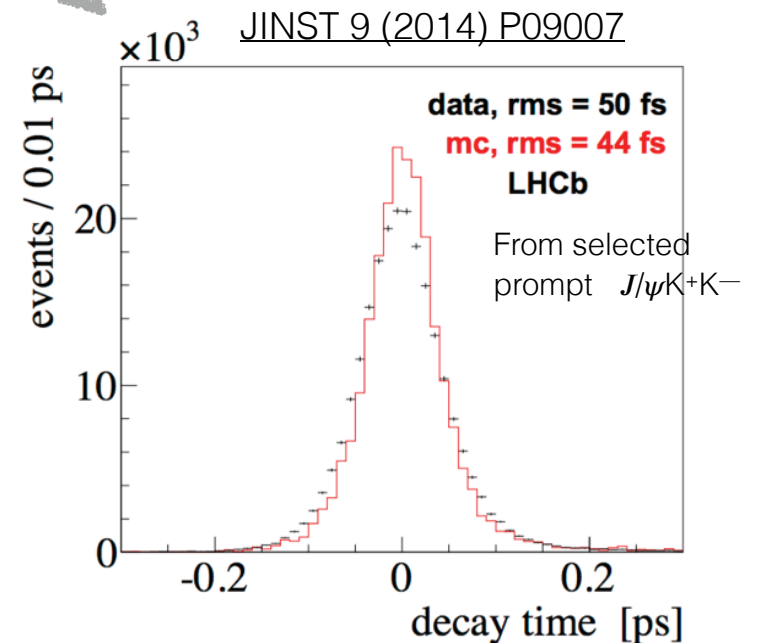

Particle Identification in LHCb is very important!

- To reduce the combinatorial background
 - Many of the interesting decay modes of b- and c-hadrons involve hadronic multi-body final states. In reconstructing the invariant mass of the decaying particle, it is important to be able to select the charged hadrons of interest to reduce combinatorics
- To discriminate final states of otherwise identical topologies, e.g. $B \rightarrow h^+h^-$ ($h=\pi,K$)
- To help in flavour tagging
 - Exploit the fact that flavoured particles are predominantly produced in pairs and use the 'other' b in the event to tag the production state by identifying charged kaons produced in $b \rightarrow c \rightarrow s$

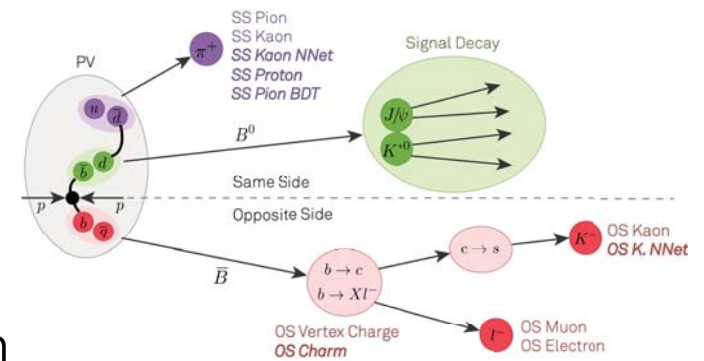

Ring-Imaging Cherenkov Detectors (RICH)

- Identification of charged hadrons (π, K, p) over a wide momentum range, from a few GeV up to 100 GeV
 - 2 separate detectors and 2 separate radiators (C_4F_{10} , CF_4) to cover full acceptance range and particle momenta

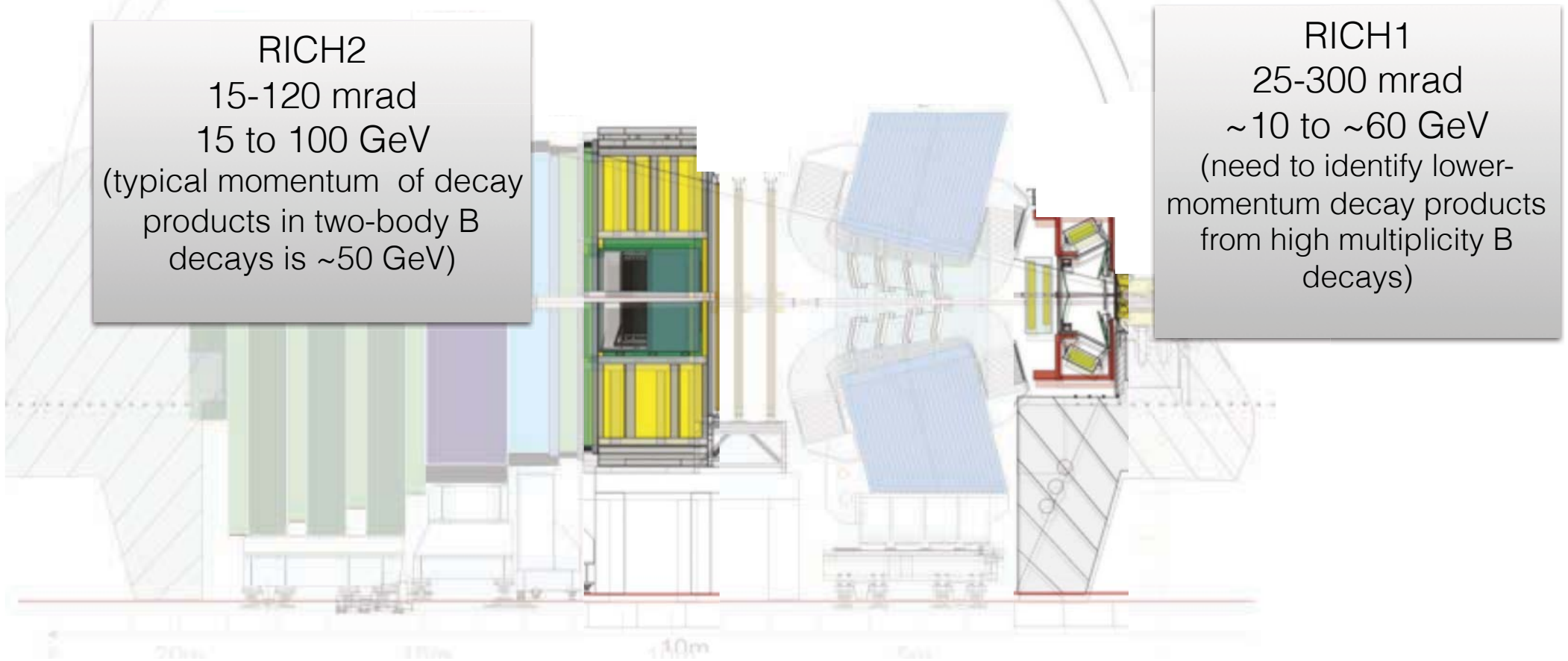

RICH Detectors

- Charged hadrons pass through a medium and when $v > c/n$, with n refractive index, emit a cone of Cherenkov photons ($\cos \theta_C = 1/\beta n$). These photons are focused by spherical mirrors and are then reflected by flat mirrors onto the photodetector planes positioned out of the LHCb acceptance.

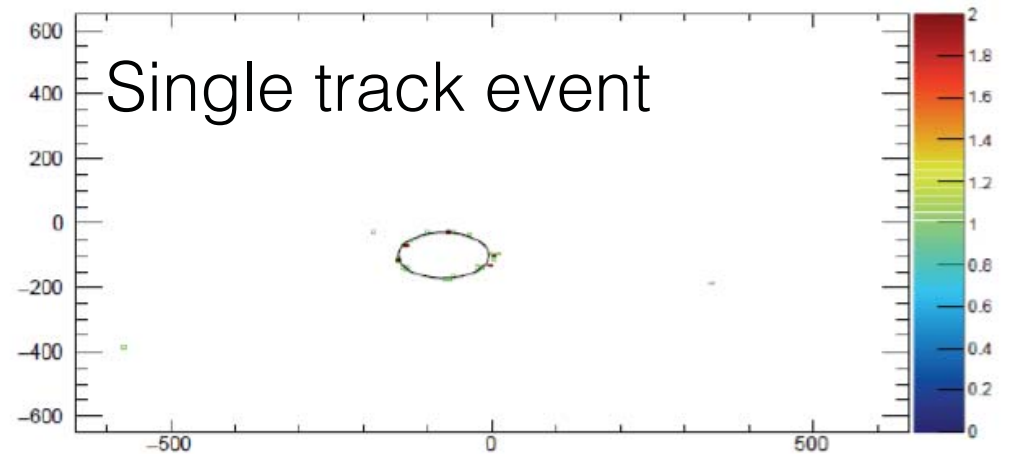
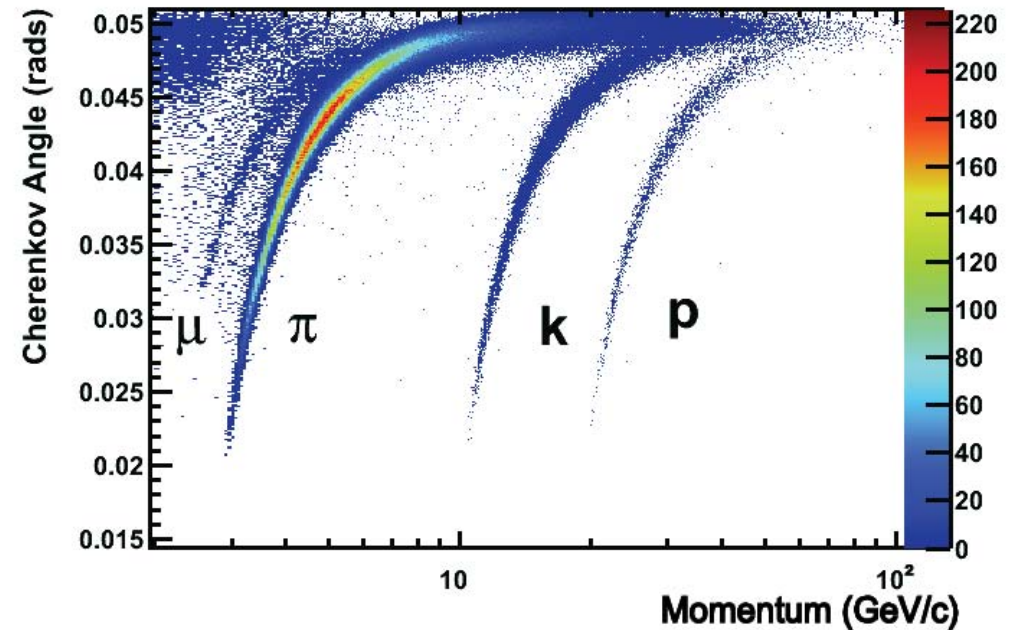
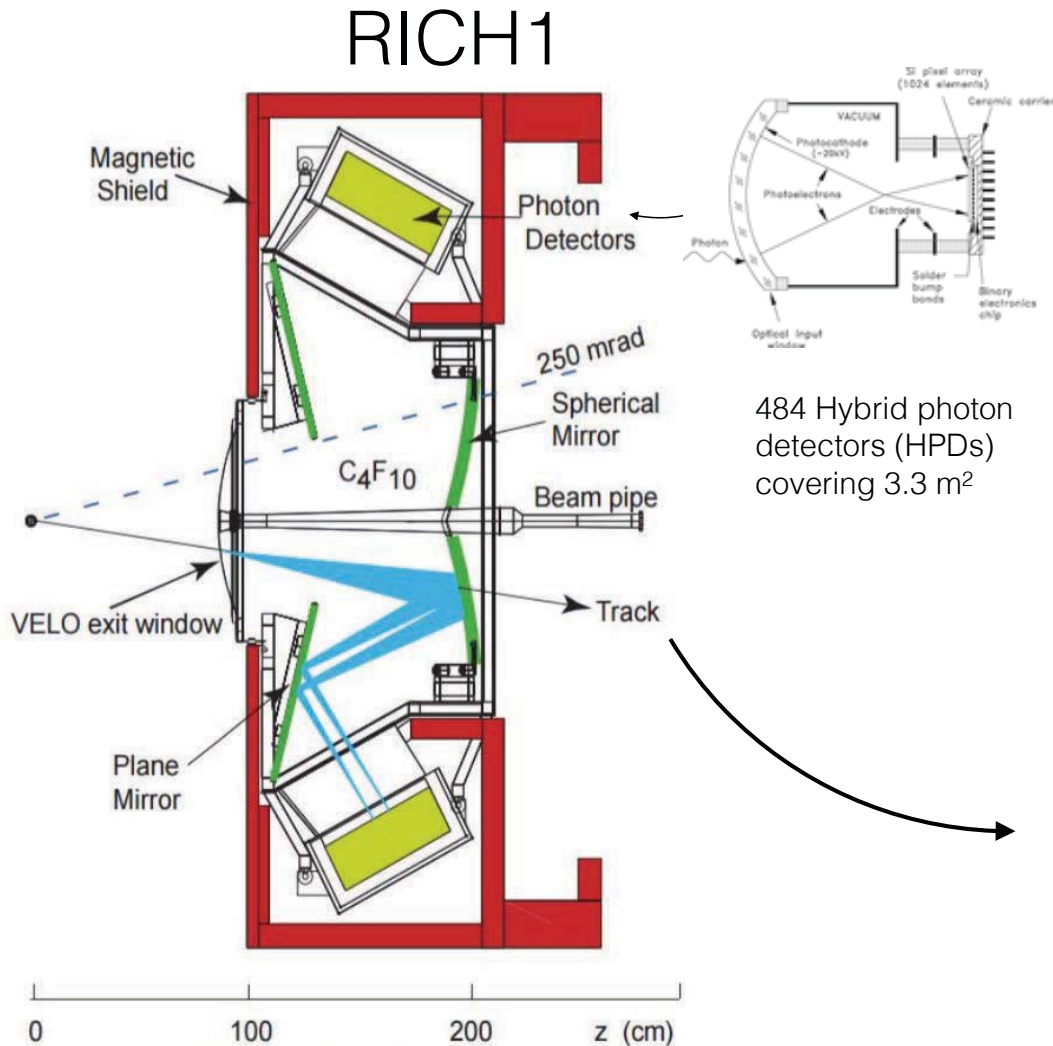

RICH Detectors

- Charged hadrons pass through a medium and when $v > c/n$, with n refractive index, emit a cone of Cherenkov photons ($\cos \theta_c = 1/\beta n$). These photons are focused by spherical mirrors and are then reflected by flat mirrors onto the photodetector planes positioned out of the LHCb acceptance.

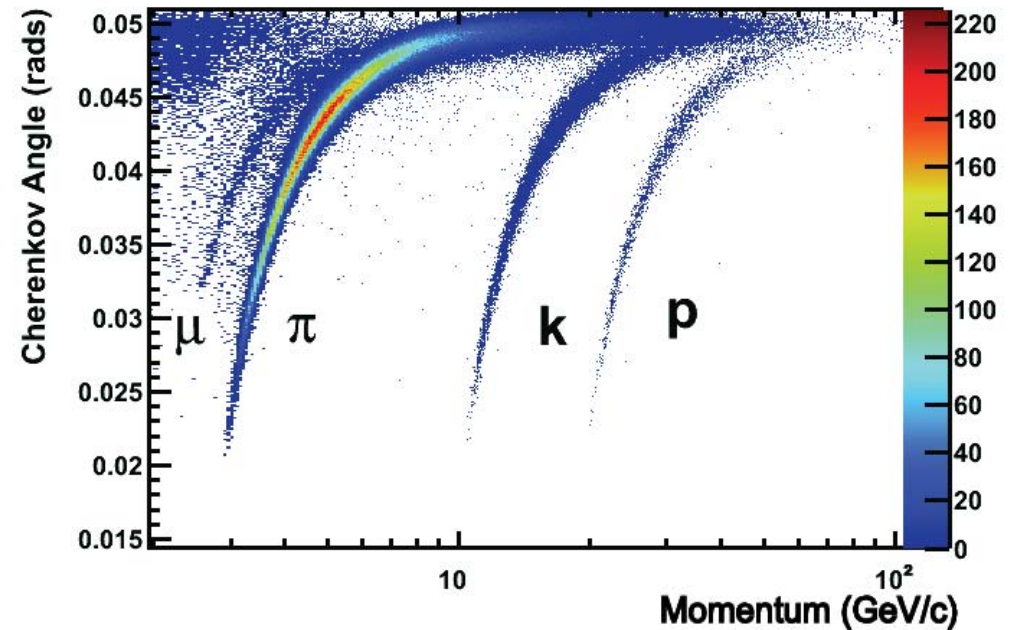
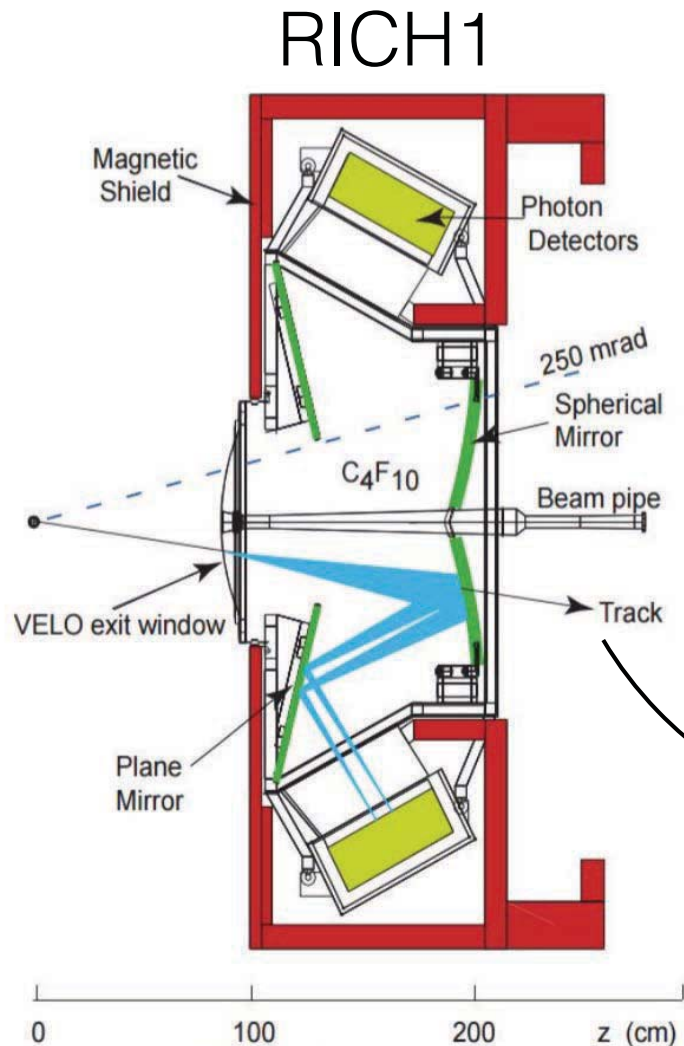

Example rings in RICH1 from run 1

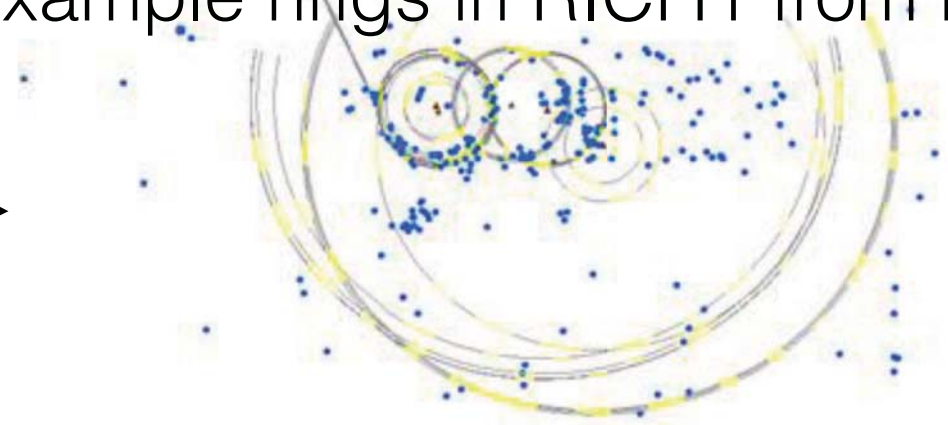

RICH performance

- K and p identification efficiency and pion (kaon) misidentification rate measured on data using control samples (Λ, K^0_S, D^0 decays)

[Eur.Phys.J.C 73 \(2013\) 2431](#)

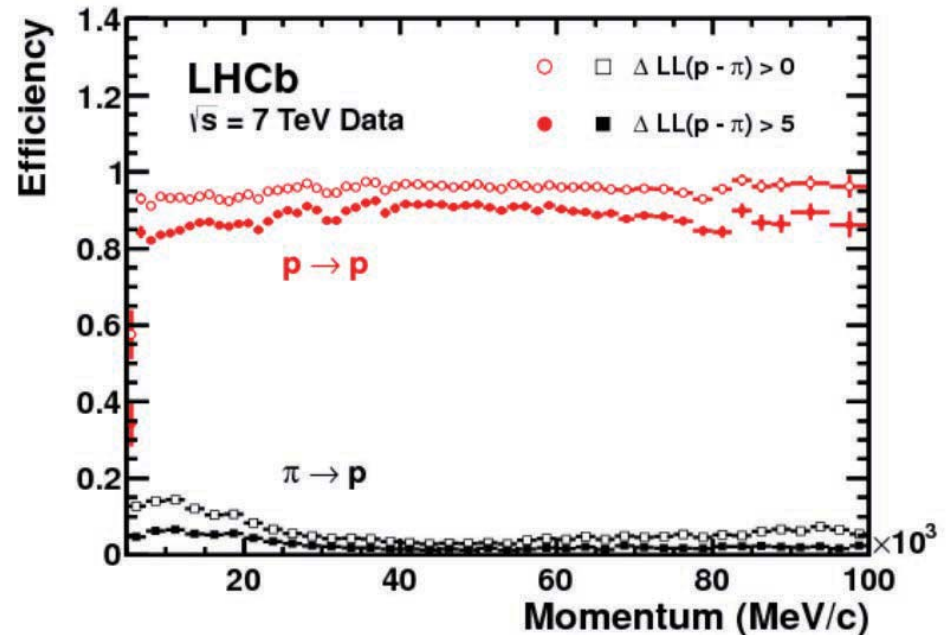
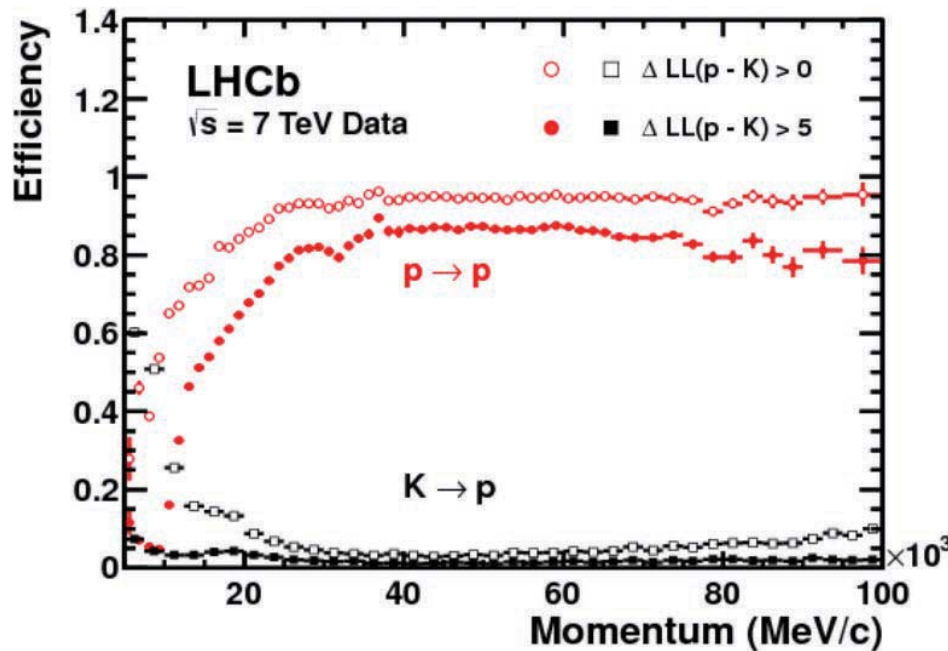
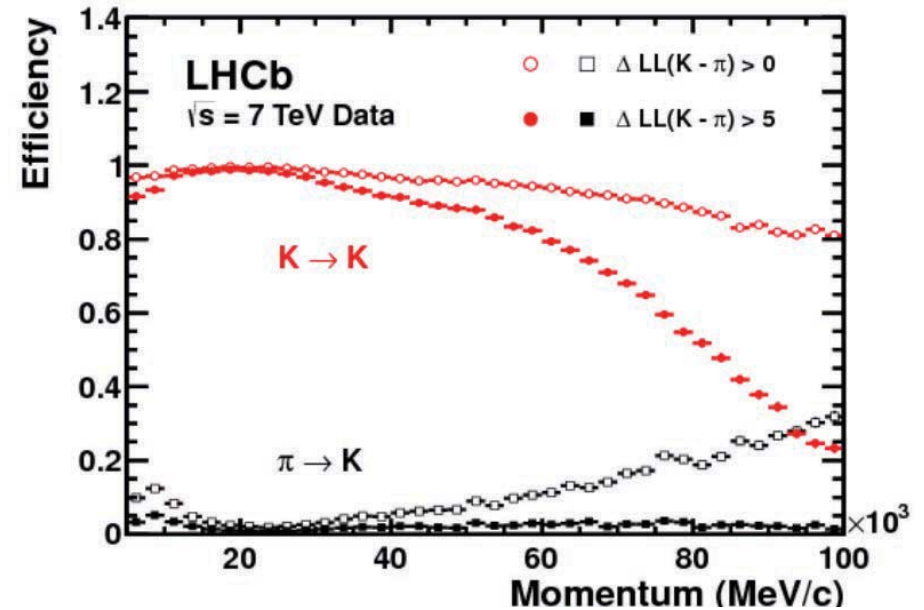

RICH performance (II)

- Invariant mass distribution for $B \rightarrow h^+h^-$ ($h=\pi,K$) **before** and **after** use of the RICH information
- Signal under study is $B \rightarrow \pi^+\pi^-$

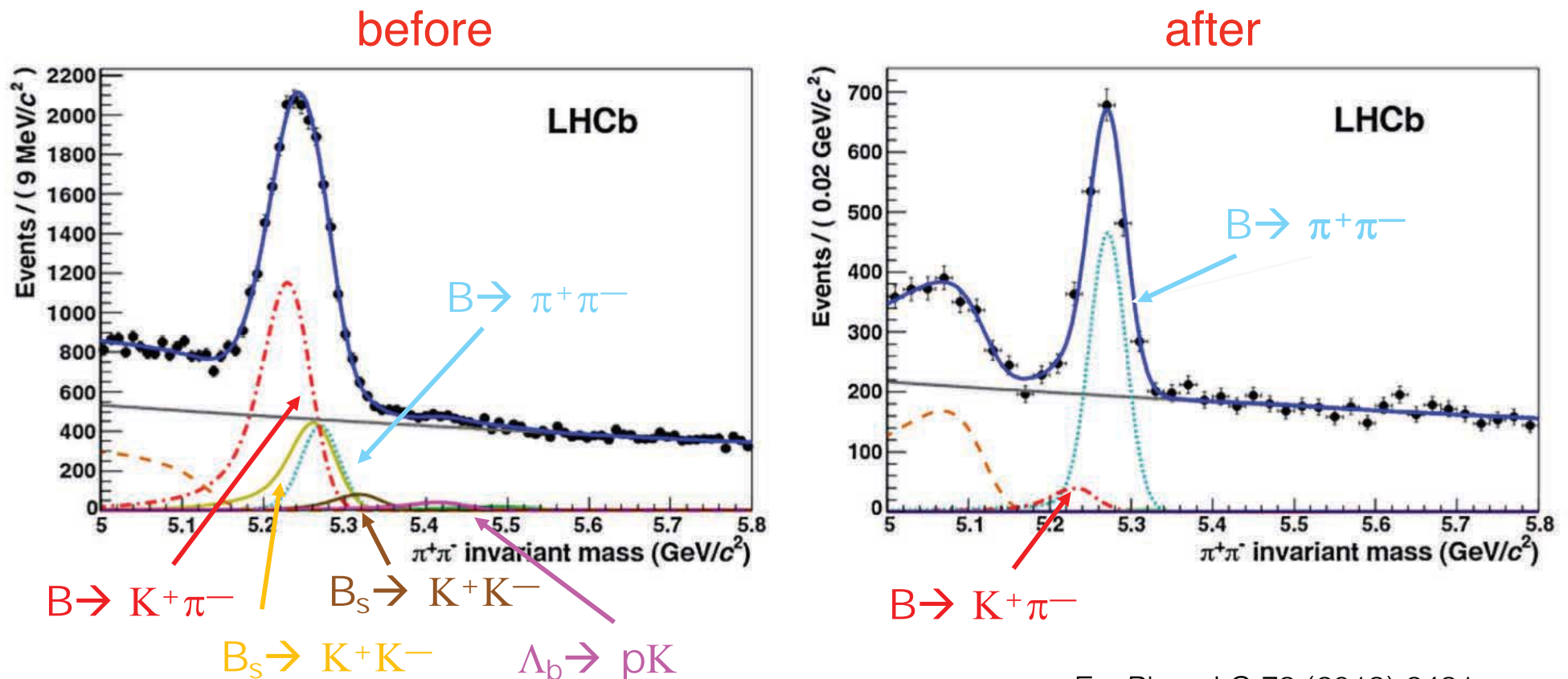

The magnet



The magnet

- Warm dipole with integrated magnetic field of 4 Tm, deflecting particles in horizontal (x-z) plane
- Magnet polarity is regularly inverted (\sim once a month) to cancel left-right asymmetries at 10^{-3} level for CP violation measurements

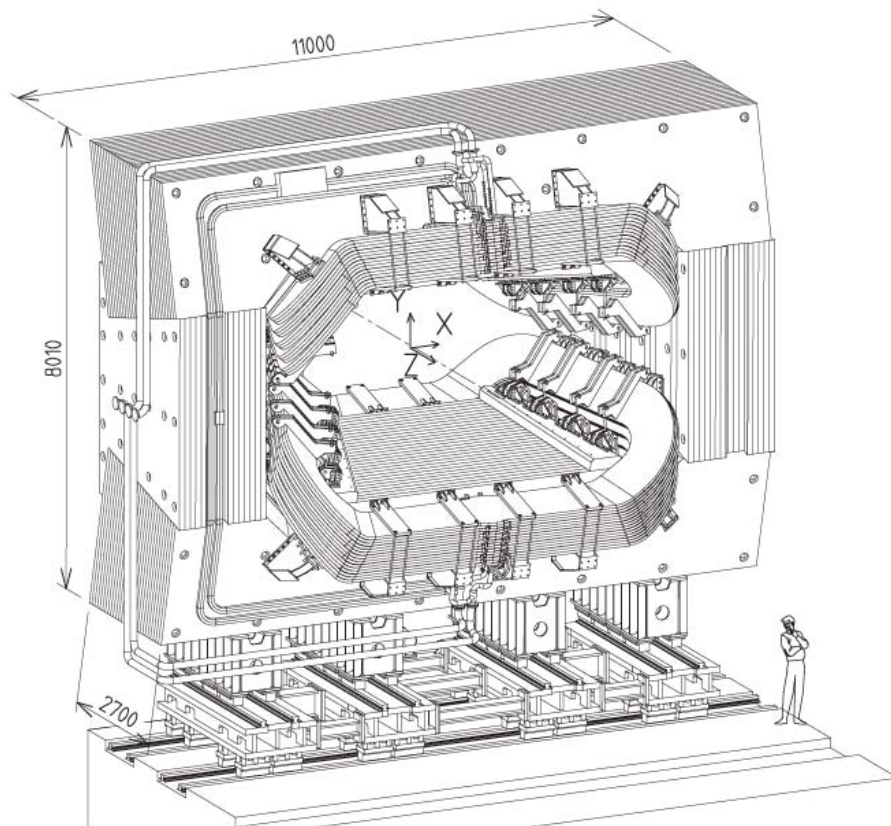

Main component B_y

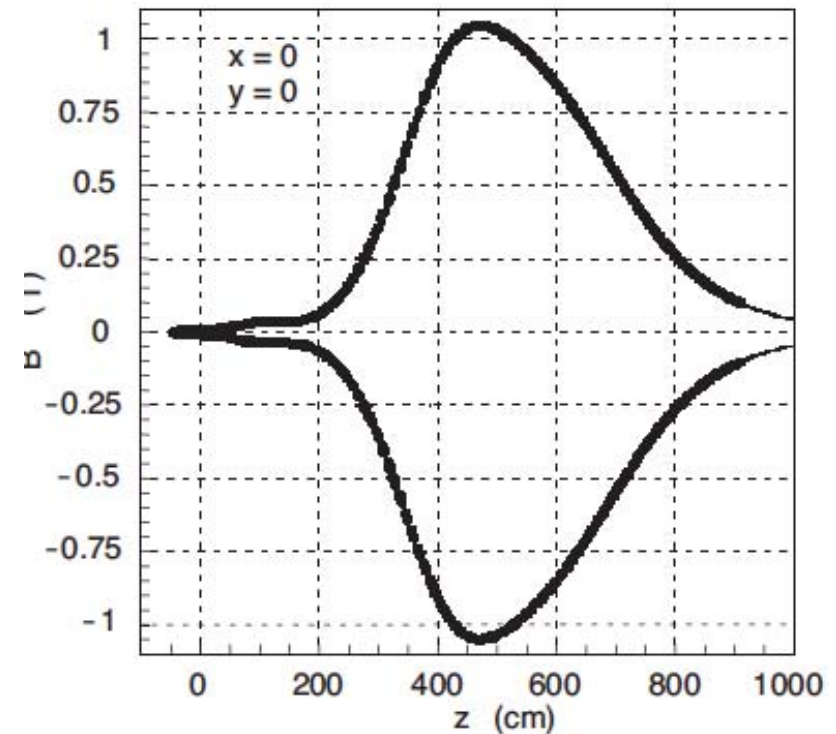

Tracking detectors (TT,IT,OT)

- TT station before the magnet: 4 planes of silicon strip detectors (vertical, -5° , $+5^\circ$, vertical), $\sim 8\text{m}^2$ of silicon, already sensitive to magnetic field, which bends tracks horizontally
- T1,T2,T3 stations after the magnet, each with 4 planes (vertical, -5° , $+5^\circ$, vertical), silicon strip detectors in the inner region (IT, 4.2m^2) as for TT, straw tubes if the outer region (OT) \rightarrow 24 straw layers in z

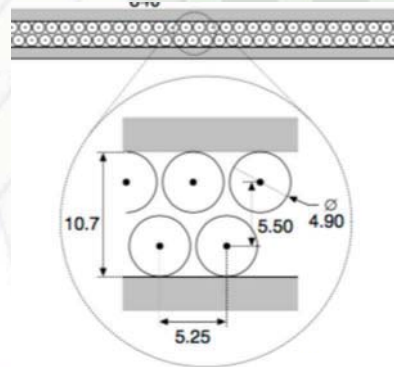
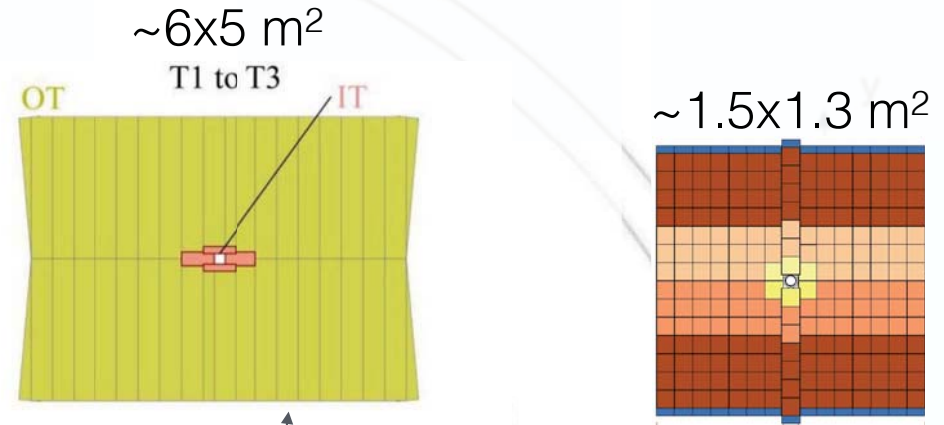

Tracking in LHCb

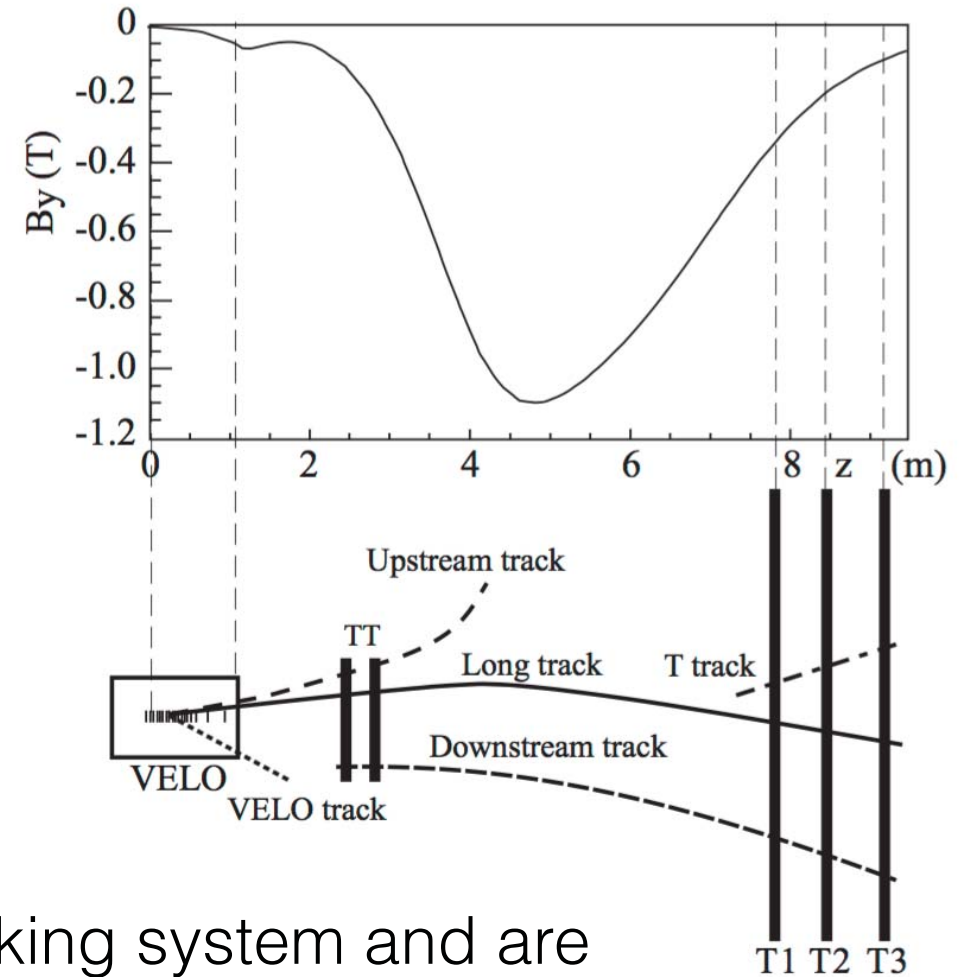
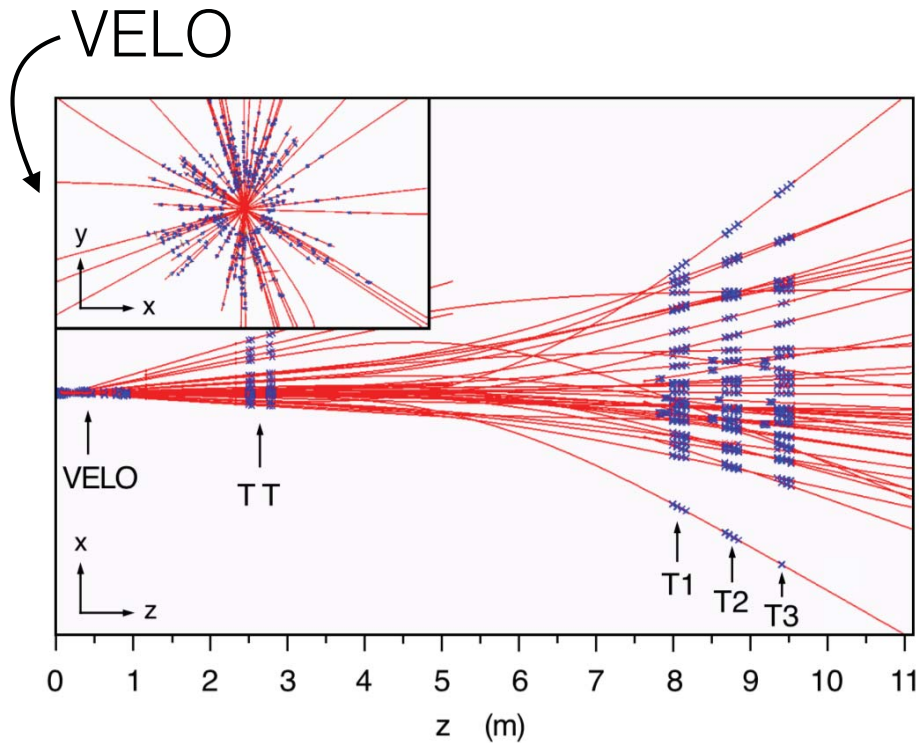

- Long tracks traverse the full tracking system and are the most important tracks for physics analysis
- Downstream tracks are important for the reconstruction of long-lived particles (e.g. K^0_s and Λ)

Tracking performance

- Tracking efficiency $> 96\%$
(measured with tag-and-probe technique with $J/\psi \rightarrow \mu^+\mu^-$)
- Relative momentum resolution for long tracks in J/ψ decays, $\Delta p/p = 0.5\text{-}1\%$
- $\Delta m/m$, is about 5 per mille up to the Y masses

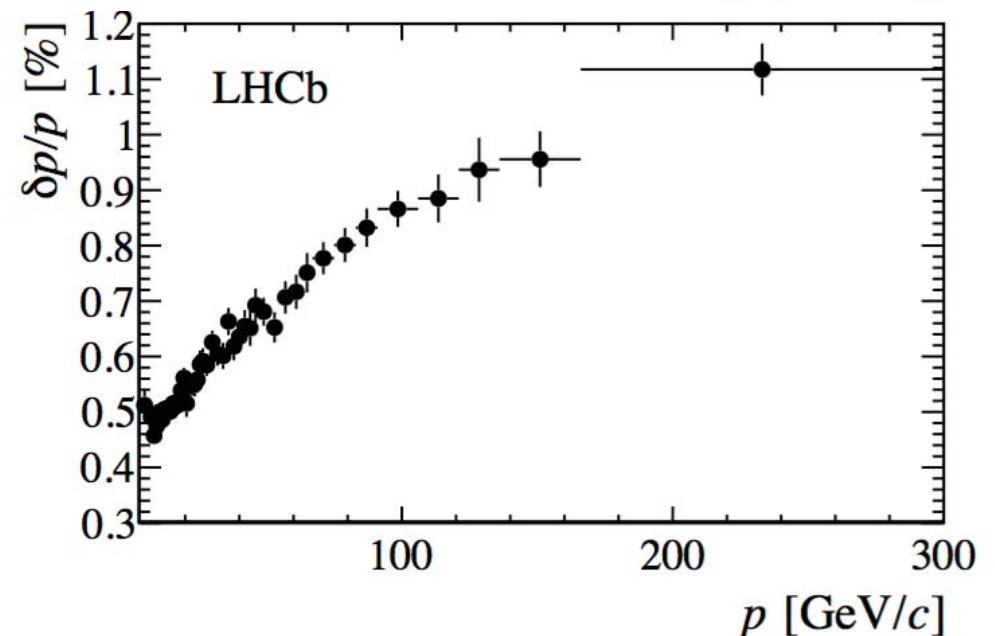
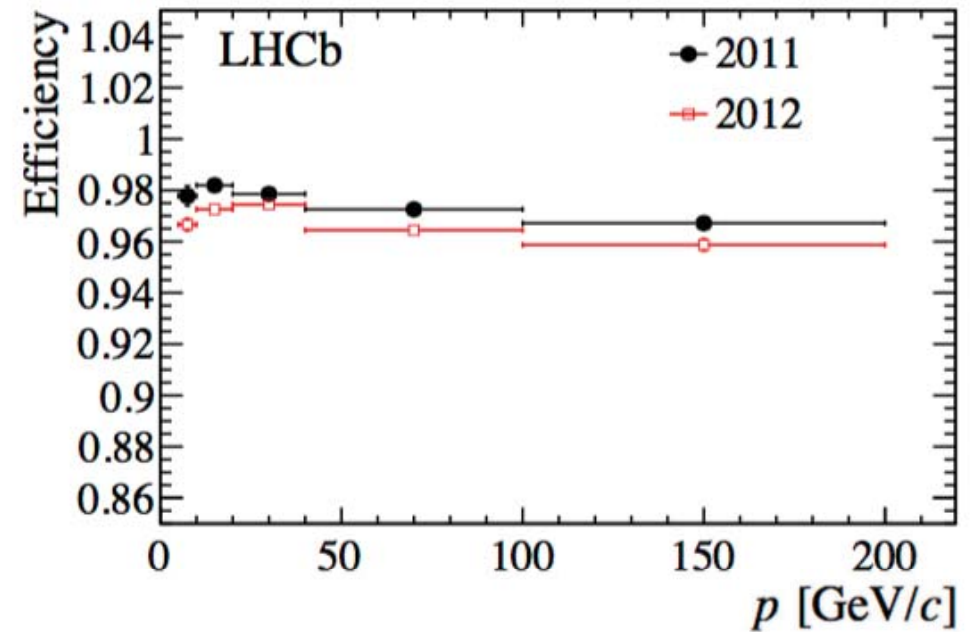

[Int. J. Mod. Phys. A30 \(2015\) 1530022](#)

Calorimeters

- Id of hadrons, electrons and photons, and measurement of their energies and positions, with sufficient selectivity and in a very short time (hardware trigger, L0)
 - Scintillator hodoscopes separated by converter
 - ECAL (shashlik, Pb-scintillator ~6000 cells)
 - HCAL (tiles, Iron-scint. ~1500 cells)

$$\frac{\delta E}{E} = \frac{10\%}{\sqrt{E}} \oplus 0.8\%$$

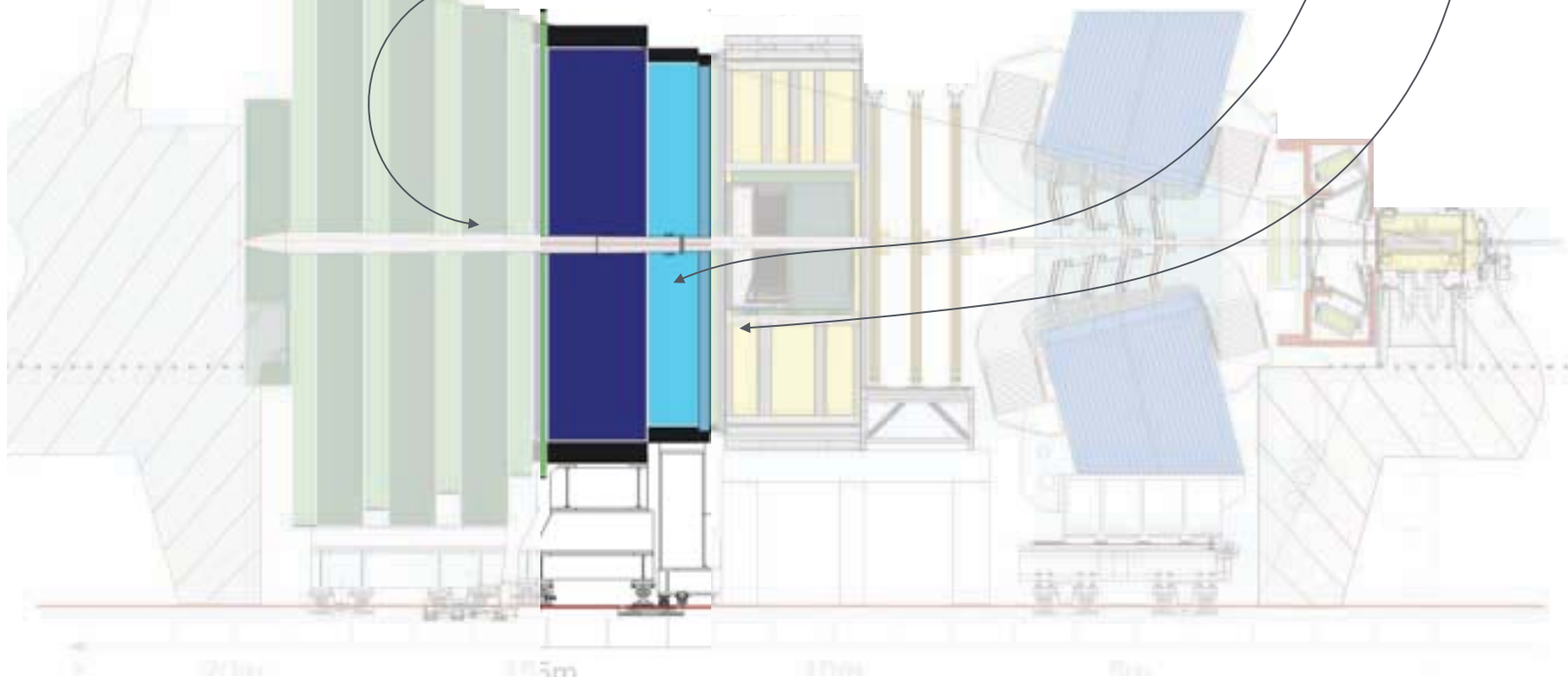

Muon Detectors

- Selection of high P_T muons at trigger level and offline muon identification
 - 5 stations M1-M5 each equipped with 276 multi-wire proportional chambers
 - Inner part of M1 equipped with GEM detectors

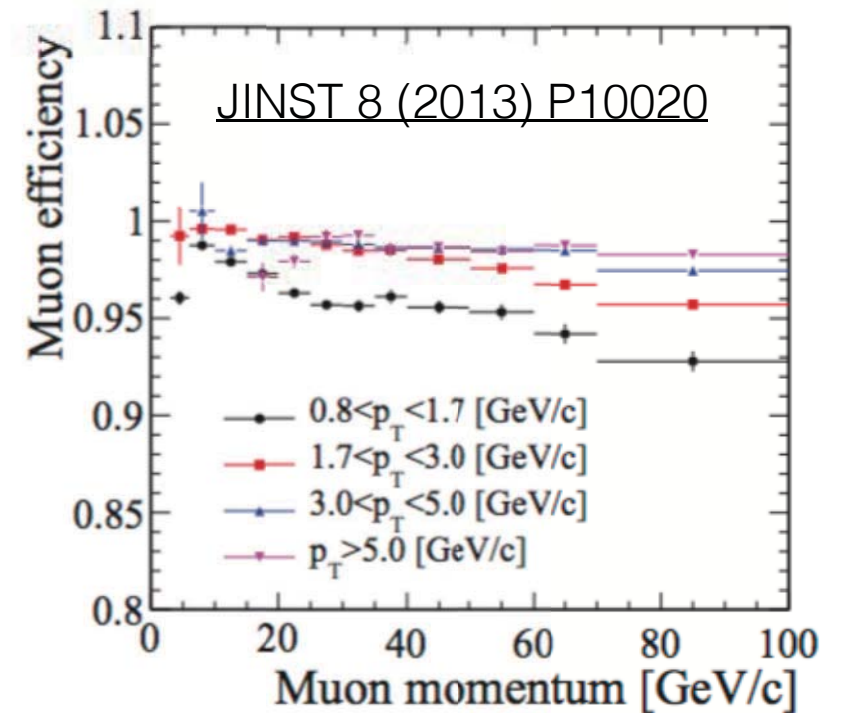
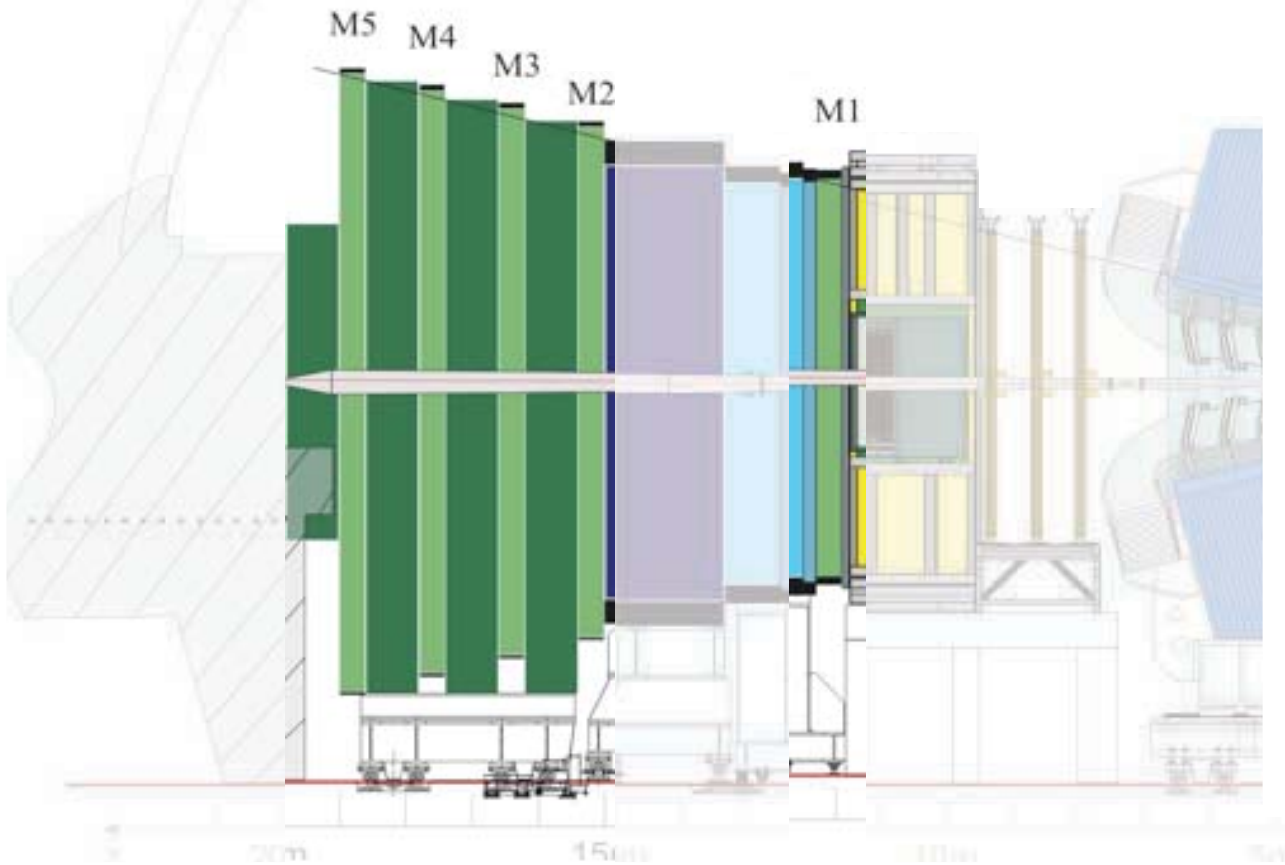

HeRSChel

(High Rapidity Shower Counters for LHCb)

- A system of forward scintillator planes closed to the beam pipe designed to register very forward activity. Three backward and two forward retractable stations at high pseudo-rapidity $\eta \equiv -\ln\left(\tan\frac{\theta}{2}\right)$

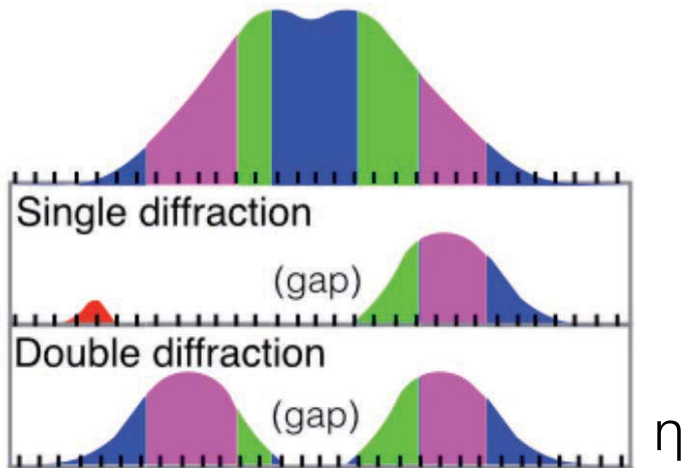
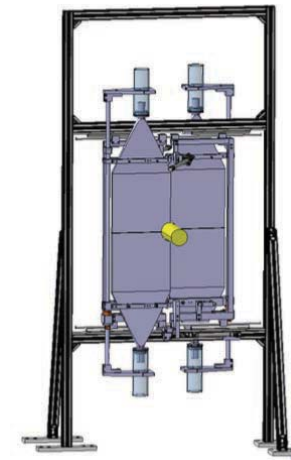
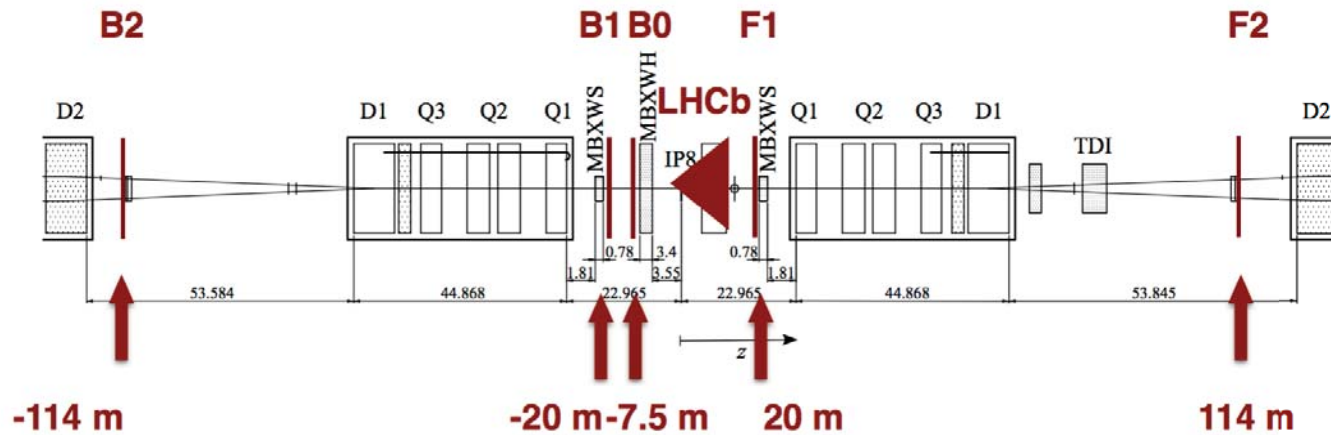
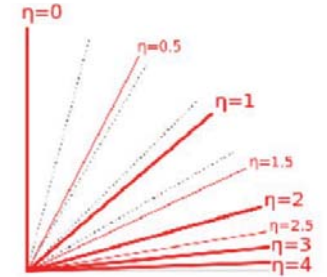

- Installed at the beginning of Run 2 to enhance LHCb's capabilities in diffractive physics

Running conditions

- LHCb designed to run at lower Lumi than ATLAS/CMS

- Mean number of interactions/bunch crossing ~ 1
- Tracking, Particle Identification sensitive to pileup

- pp beams displaced to reduce instantaneous \mathcal{L}

- $\mathcal{L} \sim 4.0 \cdot 10^{32} \text{ cm}^{-2} \text{ s}^{-1}$
- For ATLAS/CMS $\mathcal{L} \sim 10^{34} \text{ cm}^{-2} \text{ s}^{-1}$

- Huge heavy quark production cross-sections !

- $\sigma_{bb} \sim 600 \mu\text{b} @ \sqrt{s}=13 \text{ TeV}$ ($\sim 1\text{nb}$ in $e+e-$ @Y(4s))
 - $\sim 10^{11}$ b decays/fb in acceptance
- σ_{cc} is ~ 20 times larger!
 - $\sim 10^{12}$ c decays/fb in acceptance

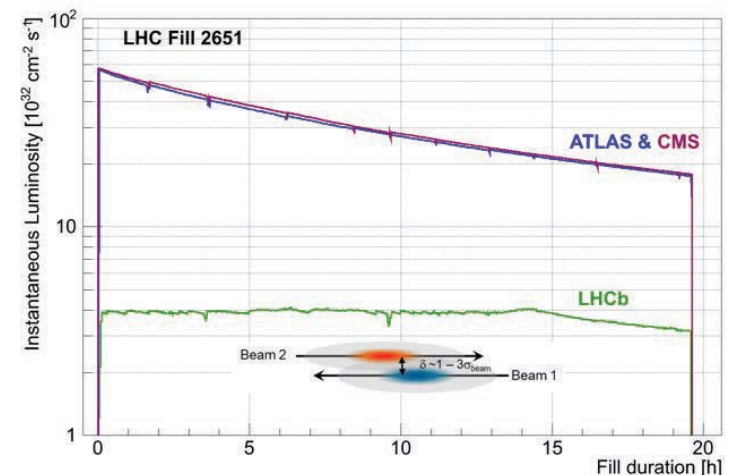
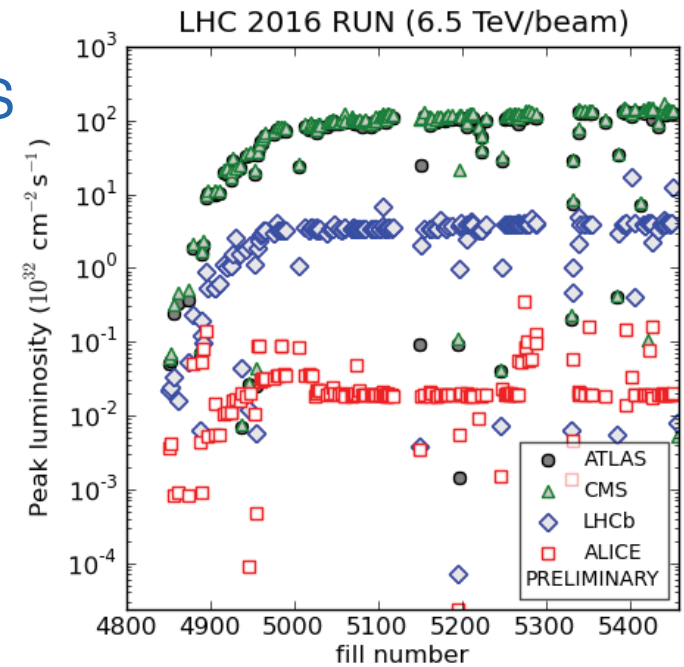

Excellent LHC performance in 2016!

- Several records beaten:
 - Fastest LHC start ever
 - LHC reached design \mathcal{L} of $1 \times 10^{34}/\text{cm}^2/\text{s}$ (ATLAS/CMS)
 - Longest fill ever with almost 38h in stable beams!
 - Stunning availability with long periods with very short turnaround time ($\sim 4\text{h}$)

LHCb Integrated Recorded Luminosity in pp, 2010-2016

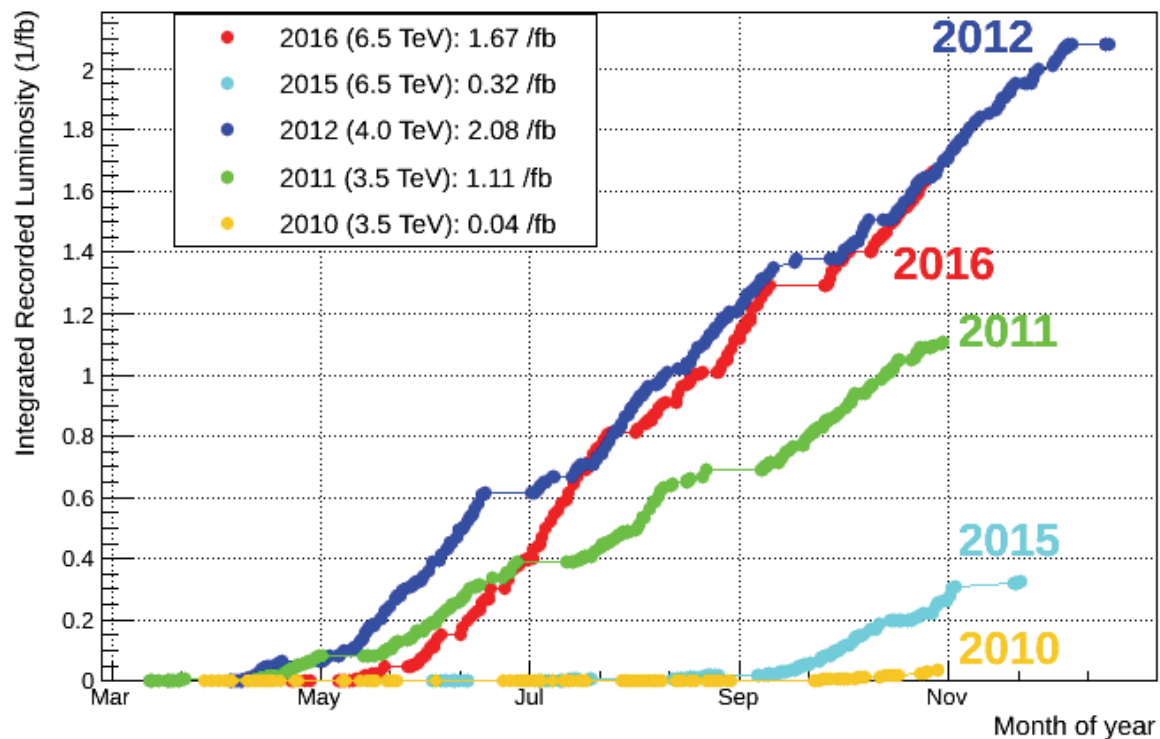

$\sim 3/\text{fb}$ @ 7-8 TeV in Run 1 (2010-2013)
 $\sim 2/\text{fb}$ @ 13 TeV in Run 2 (2015-2018)

LHCb Integrated Luminosity in p-Pb/Pb-p in 2016

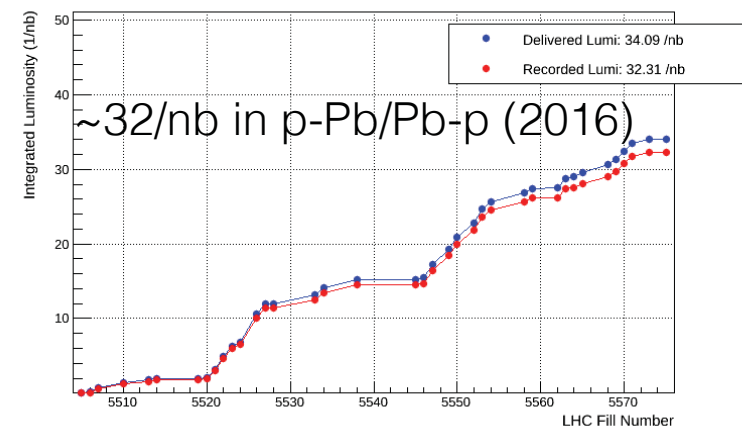

The trigger

- For LHCb, more data more important than higher energy
 - Direct searches @ATLAS/CMS: more energy → new particles could appear above threshold
 - Indirect searches: precision measurements → gain from increased production rates
- However, digesting more data is a true challenge!
 - At 13 TeV and $L=4 \times 10^{32}/\text{cm}^2/\text{sec}$, ~ 45 kHz $b\bar{b}$ and ~ 1 MHz $c\bar{c}$ pairs in detector acceptance
 - Most interesting b-hadron decays occur at 10^{-5} probability or lower
 - Big challenge → requires powerful trigger

Selectivity example

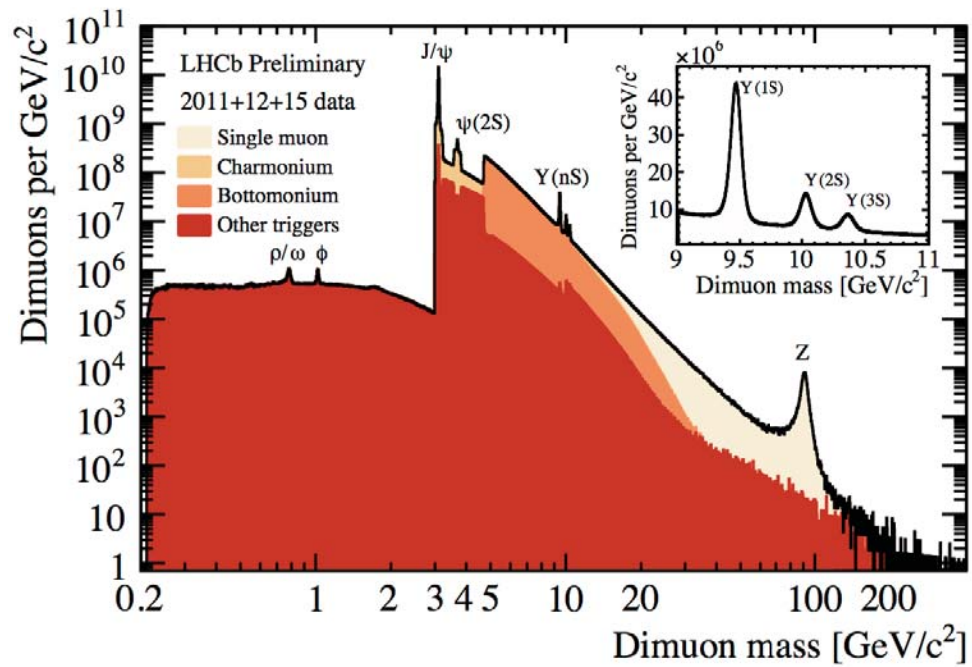

Di-muon distribution split by trigger group
(LHCb-CONF-2016-05)

Selectivity example

NEW!
EP seminar @CERN
14 February

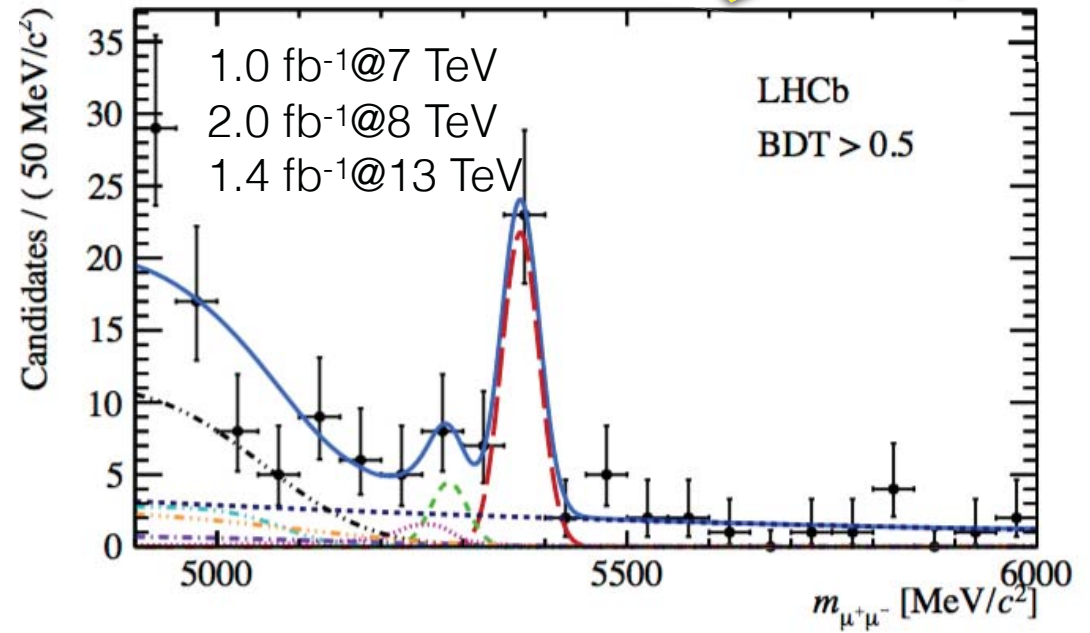
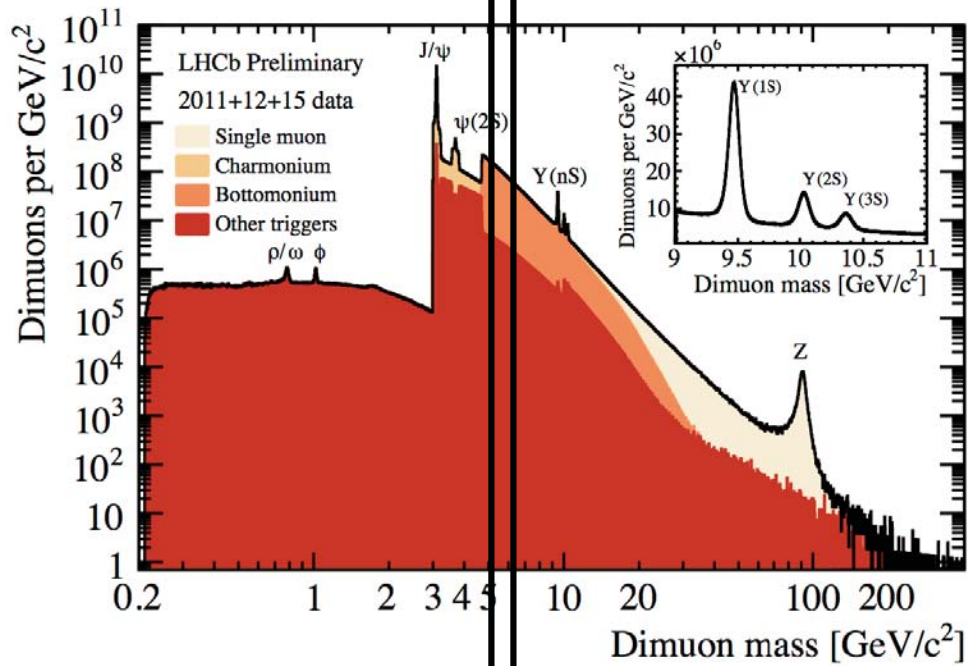

Di-muon distribution split by trigger group (LHCb-CONF-2016-05)

$\mathcal{B}(B_s^0 \rightarrow \mu^+ \mu^-) = (2.8 \pm 0.6) \times 10^{-9}$
 $\mathcal{B}(B^0 \rightarrow \mu^+ \mu^-) < 3.4 \times 10^{-10}$
 A significance of 7.8σ !

Finding a needle in a haystack!

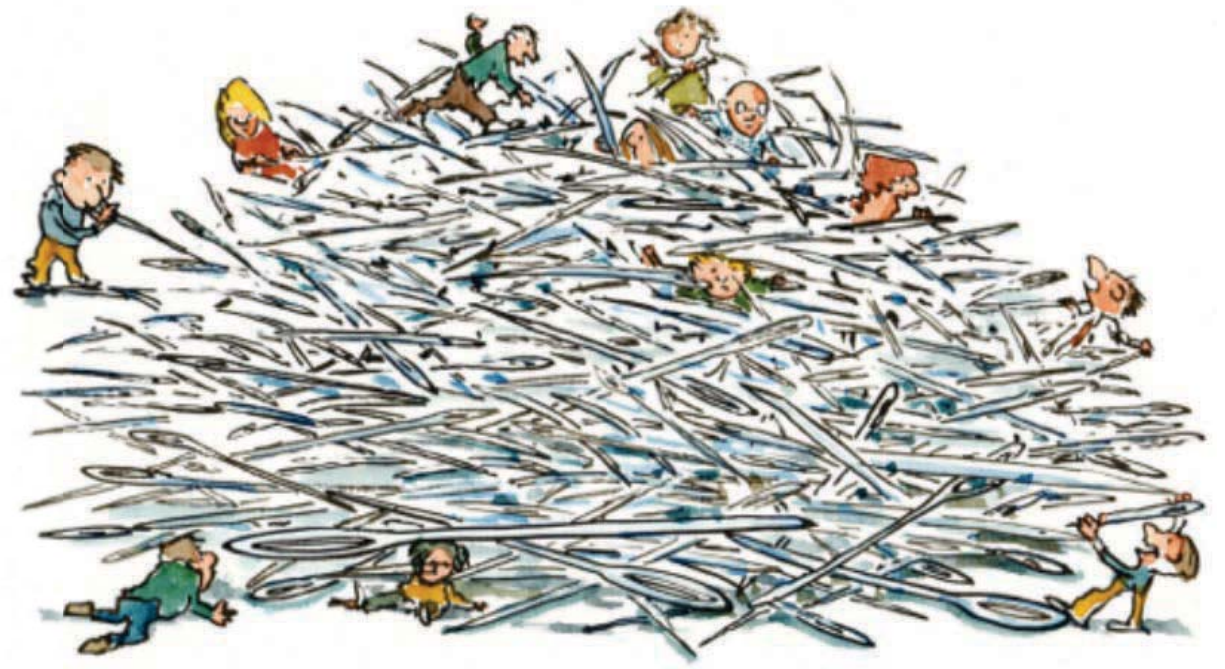

$B^0_{(s)} \rightarrow \mu^+ \mu^-$ discrimination

Dominant background from $b\bar{b} \rightarrow \mu^+ \mu^- X$

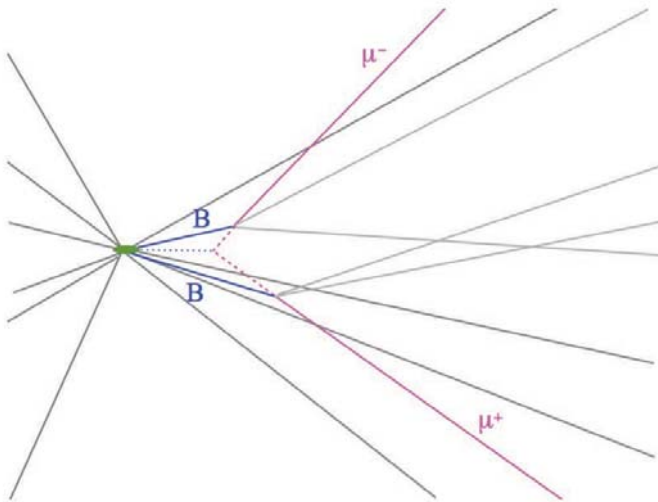

Signal: two muons from a single well-reconstructed event

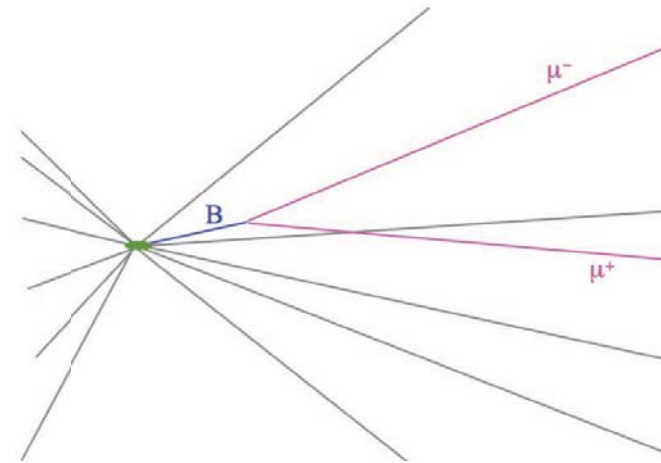

- A multivariate classifier (BDT) based on kinematic and geometrical variables is used to discriminate between signal and combinatorial background; BDT trained on simulation, calibrated using data
- Search window 'blind' until analysis optimised

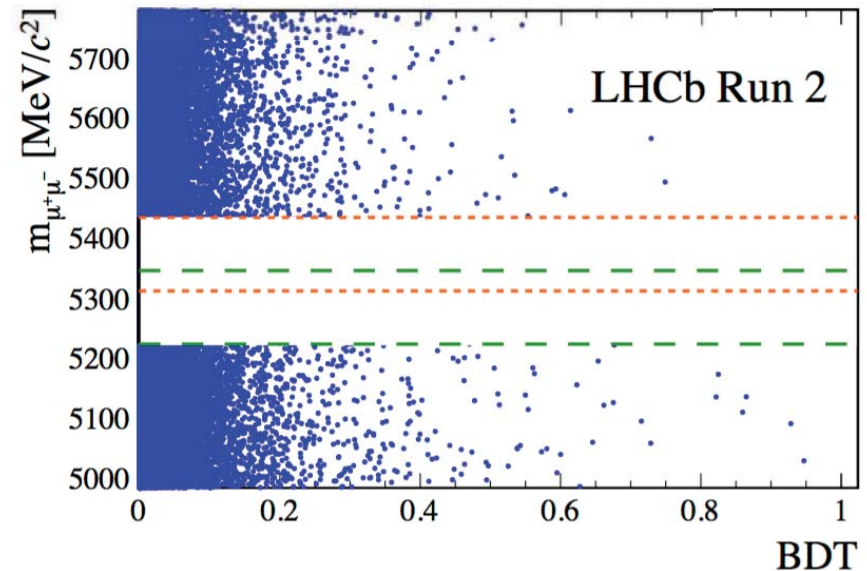

A nice candidate



Event 1896231802
Run 177188
Wed, 15 Jun 2016 21:35:20

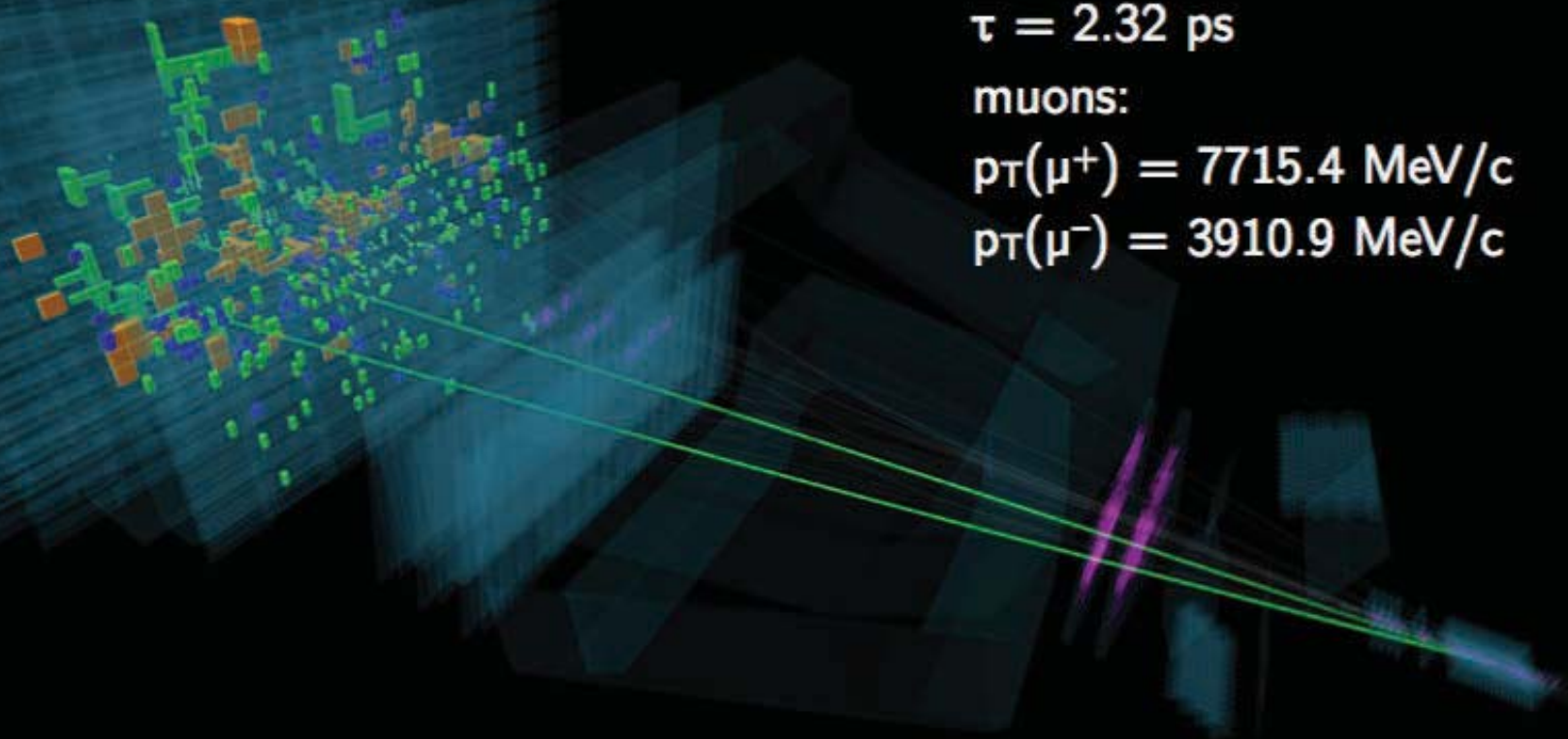

B:

mass = 5379.31 MeV/c²

$p_T(B) = 11407.5$ MeV/c

BDT = 0.968545

$\tau = 2.32$ ps

muons:

$p_T(\mu^+) = 7715.4$ MeV/c

$p_T(\mu^-) = 3910.9$ MeV/c

A nice candidate



Event 1896231802
Run 177188
Wed, 15 Jun 2016 21:35:20

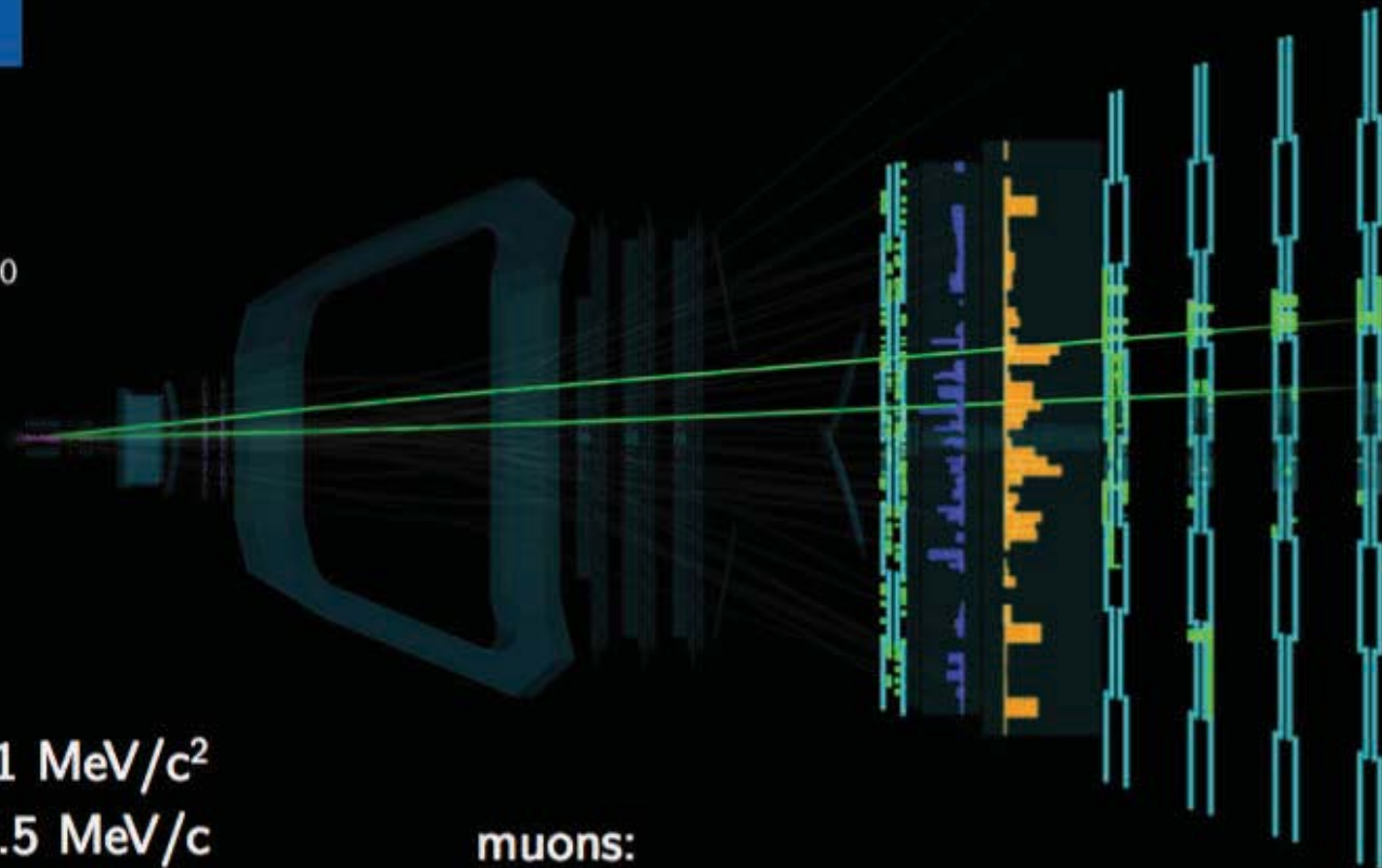

B:

$$\text{mass} = 5379.31 \text{ MeV}/c^2$$

$$p_T(B) = 11407.5 \text{ MeV}/c$$

$$\text{BDT} = 0.968545$$

$$\tau = 2.32 \text{ ps}$$

muons:

$$p_T(\mu^+) = 7715.4 \text{ MeV}/c$$

$$p_T(\mu^-) = 3910.9 \text{ MeV}/c$$

A nice candidate



Event 1896231802

Run 177188

Wed, 15 Jun 2016 21:35:20

B:

mass = 5379.31 MeV/c²

p_T(B) = 11407.5 MeV/c

BDT = 0.968545

τ = 2.32 ps

muons:

p_T(μ⁺) = 7715.4 MeV/c

p_T(μ⁻) = 3910.9 MeV/c

Good agreement with the SM! (as usual)

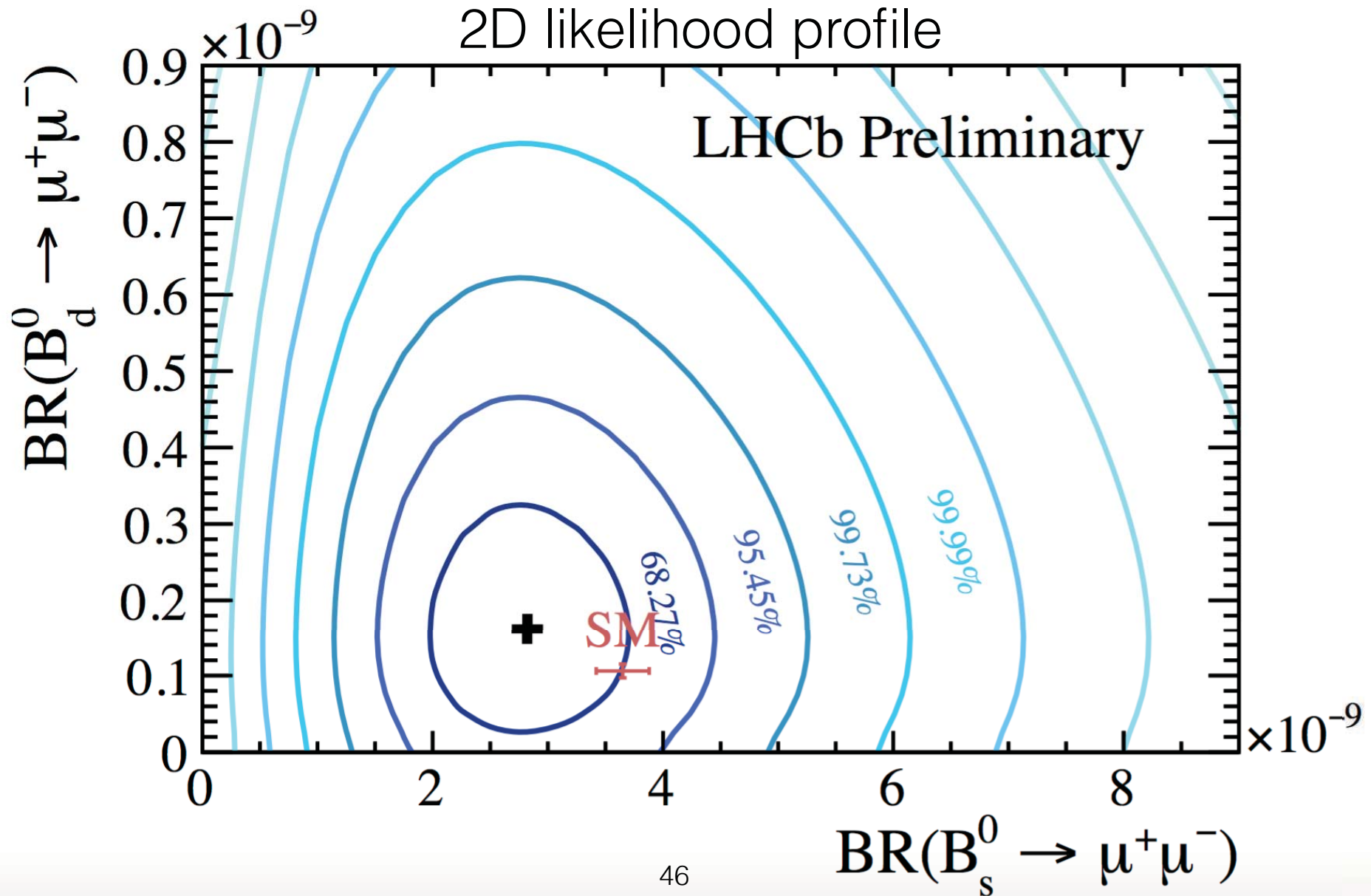

The SM stands its ground

- A large class of theories that extend the Standard Model into NP, such as Supersymmetry, predicts significantly higher values for the $B_{(s)}^0$ decay probability

From D. Straub

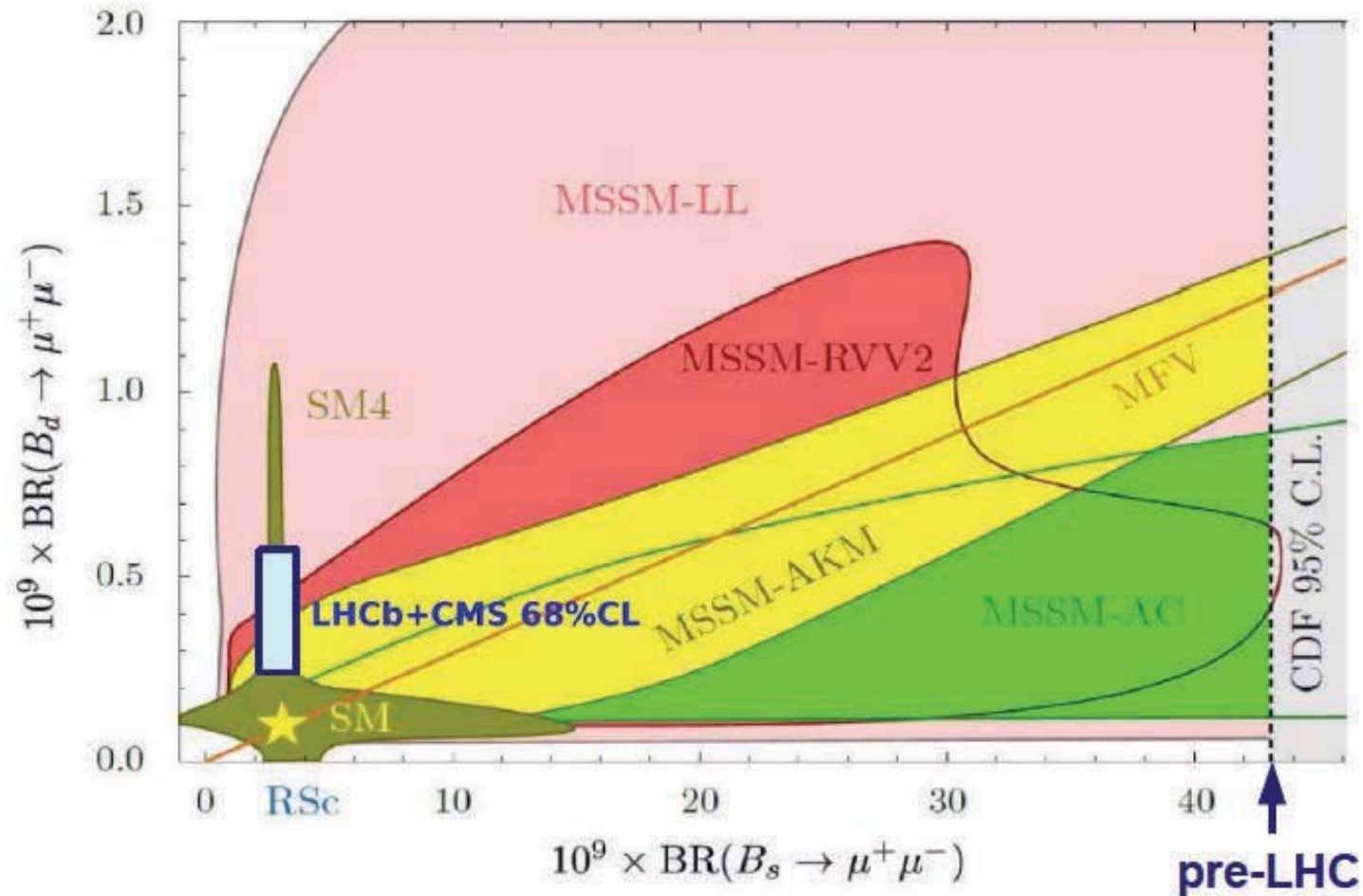

The trigger (II)

- Three-level trigger system of increasing complication
- First trigger level (L0) is implemented in hardware with $4\mu\text{s}$ latency
 - L0 is based on calorimeter and muon systems
 - Criteria are based on the deposit of several GeV of transverse energy, E_T , by charged hadrons, muons, electrons or photons
 - Typical thresholds: Muon $p_T > 2$ GeV, Hadron $E_T > 4$ GeV,
 - L0 reduces rate from 40 MHz to **1 MHz, mandated by the fact that the full LHCb detector can only be read out at 1 MHz**
 - **Two-stage software High Level Triggers (HLT)**: software application executed on a large computing cluster, designed to reduce the event rate from 1 MHz to ~ 12 kHz - Running 40 k jobs simultaneously in Run 2!

Evolving strategy for the High Level Trigger

Run 1 trigger diagram

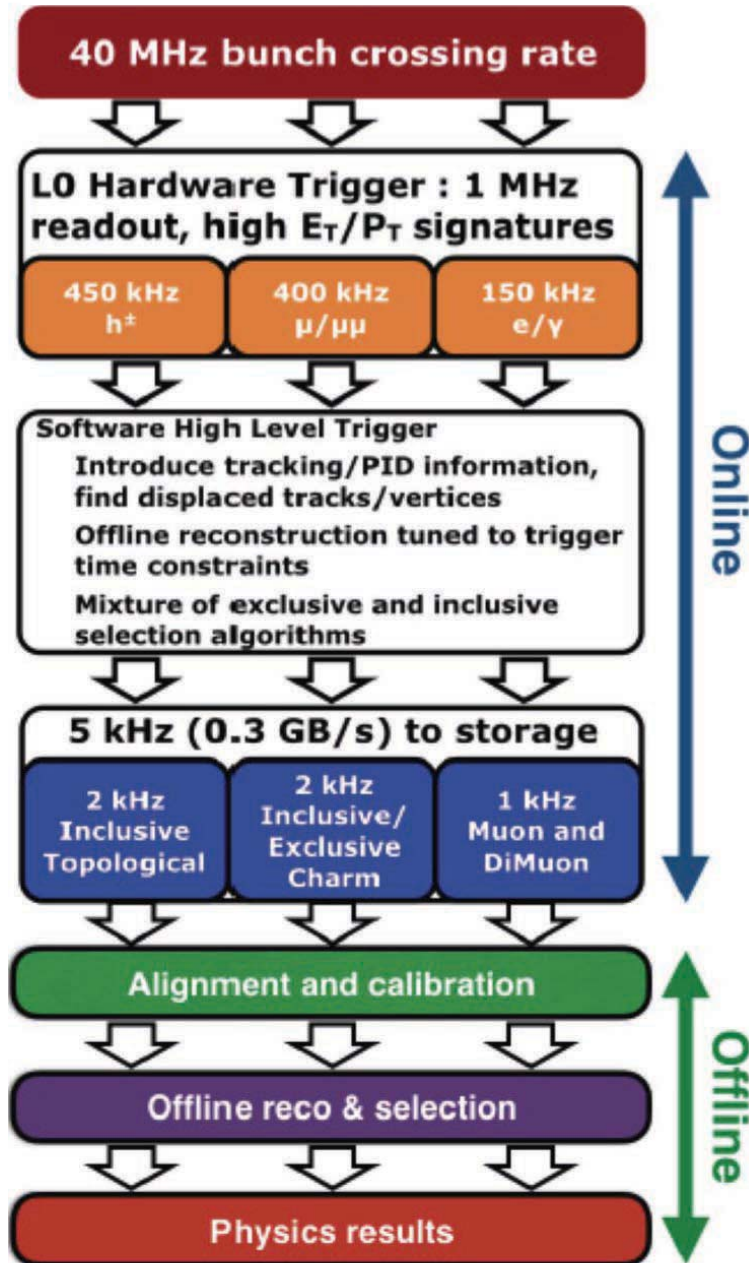

“Traditional model”

- **Online reconstruction** as good as possible within CPU budget, based on preliminary alignment & calibration. Fast, but less performing than full offline reconstruction.

- **Offline reconstruction** based on full detector alignment & calibration

- Obvious disadvantages of this model:

- time (e.g. reconstruction done twice)
- money: costs a lot in terms of computing resources
- physics: some data lost by an imperfect reconstruction at trigger level

Evolving strategy for the High Level Trigger

Run 1 trigger diagram

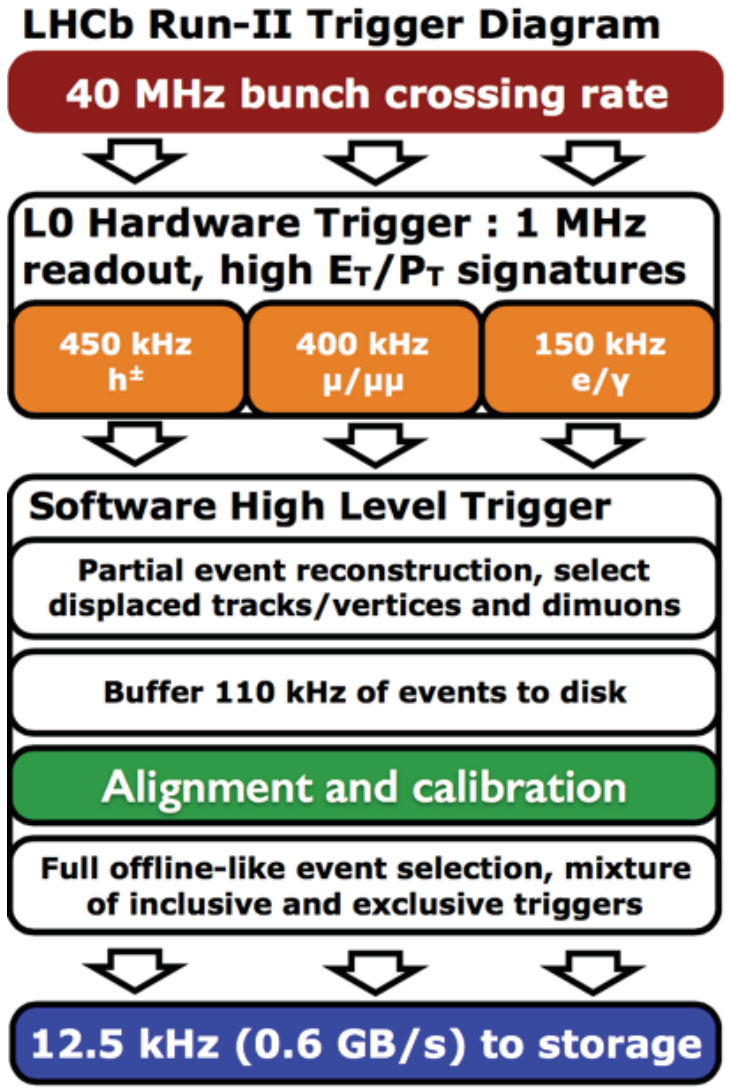
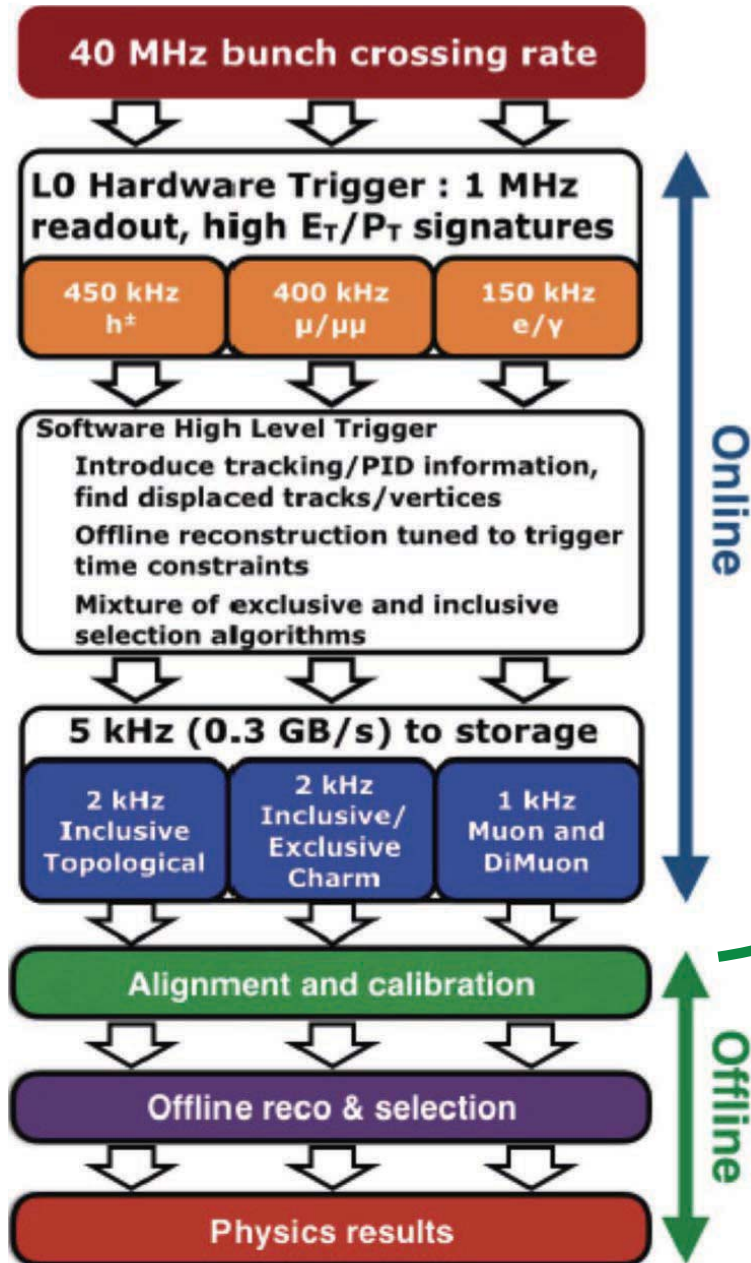

Evolving strategy for the High Level Trigger

- Split the HLT!
- At the 1st stage of the HLT (HLT1) reconstruct charged particle trajectories using information from the VELO and tracking stations
- Store output on online farm disk buffers (10 pb available in 2016)
- Enough time to perform **calibration and alignment** before the 2nd trigger stage (HLT2) where offline offline-quality reconstruction is performed
- Same constants used by trigger and offline reconstruction
- No need to reprocess and more discriminant trigger!
- **Trigger = Offline → best performance !**

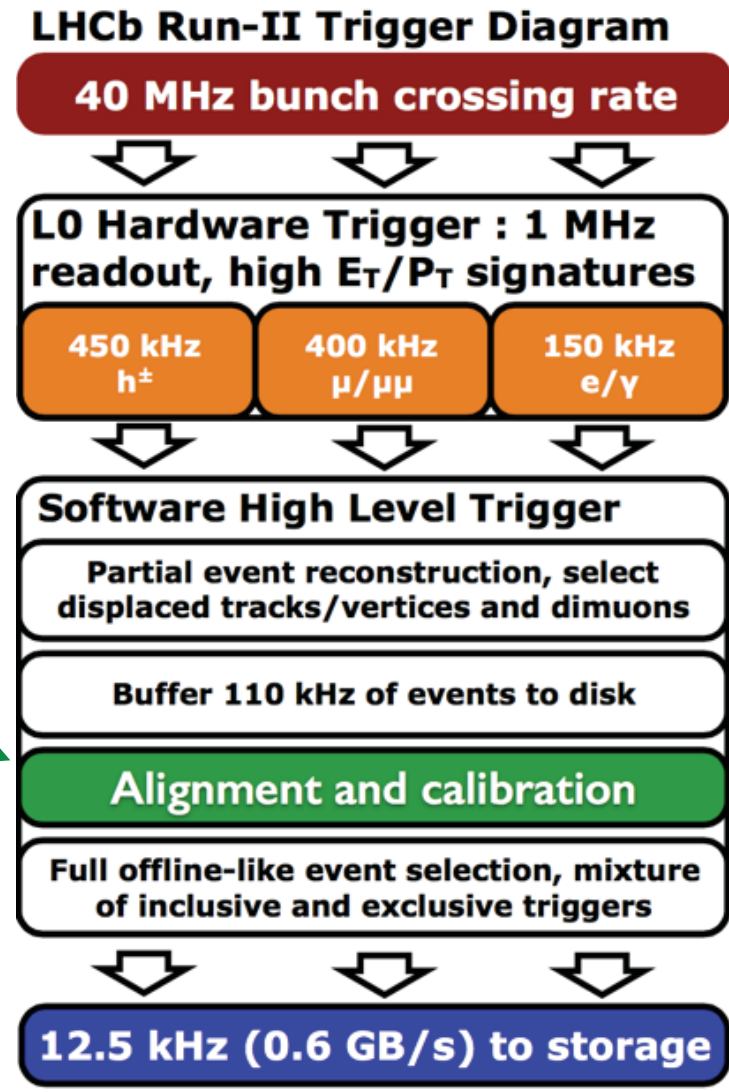

Importance of real-time alignment & calibration

- Store less background
- Alignment improves the mass resolution of the peaks
- PID allows separating the interesting channels → obvious benefit in having it available at trigger level

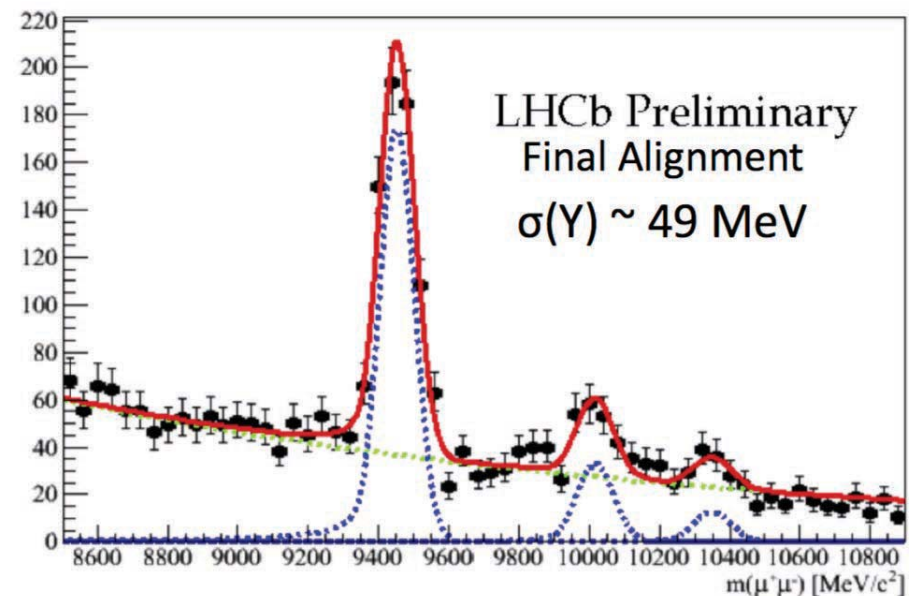
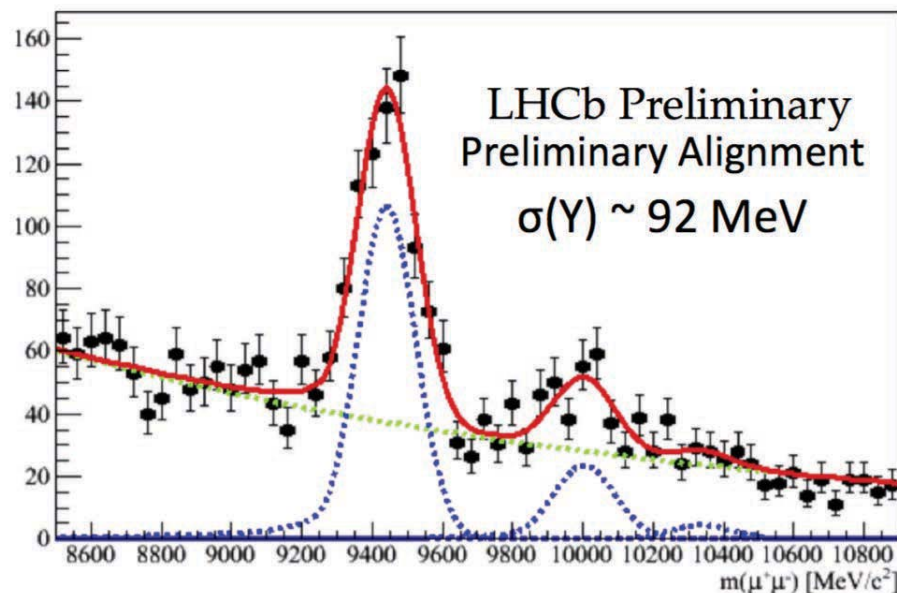

Real-time Alignment of Tracking System

- VELO, Tracker, Muon
- Complex process: alignment of about 700 elements allowing for translation and rotation
- Fast: ~ 7 minutes per task
- Runs automatically once per fill - minimises residuals of track fits

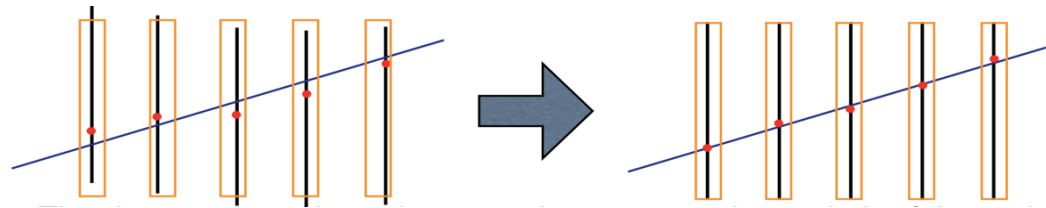

- Dedicated data samples collected for each subsystem (e.g. $J/\Psi \rightarrow \mu\mu$ for muon system)
- Tracking constants updated only when necessary
 - VELO: every ~ 5 fills
 - Tracker: every ~ 10 fills; very likely after magnet polarity switch or detector intervention
 - Muon: in general no update necessary except after hardware interventions, however system also monitored

Real-time Alignment of Tracking System (II)

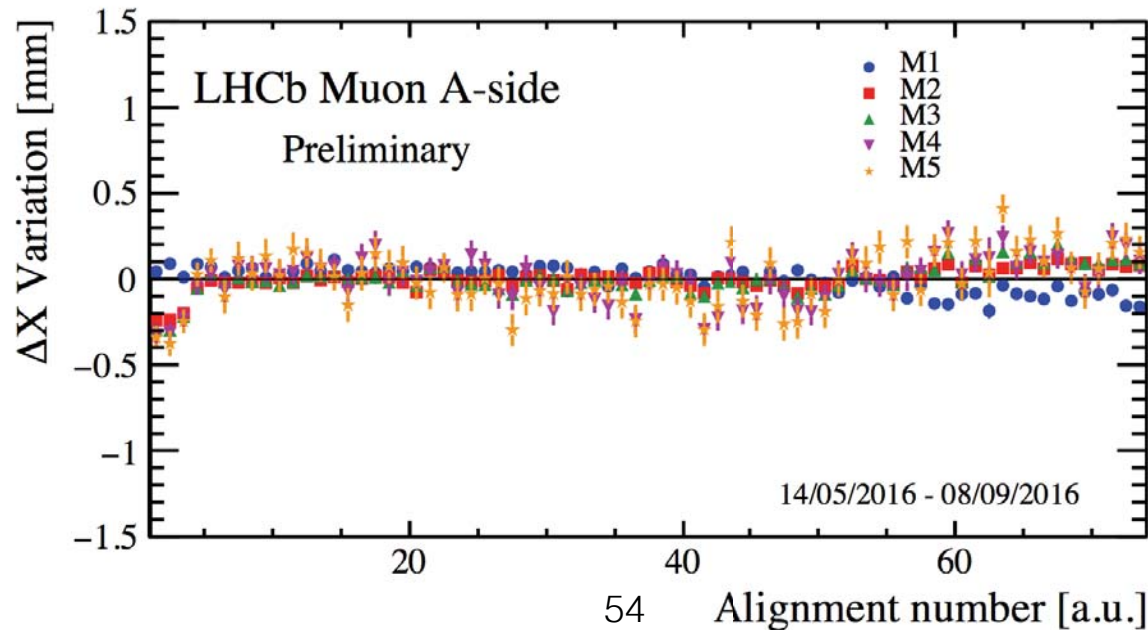
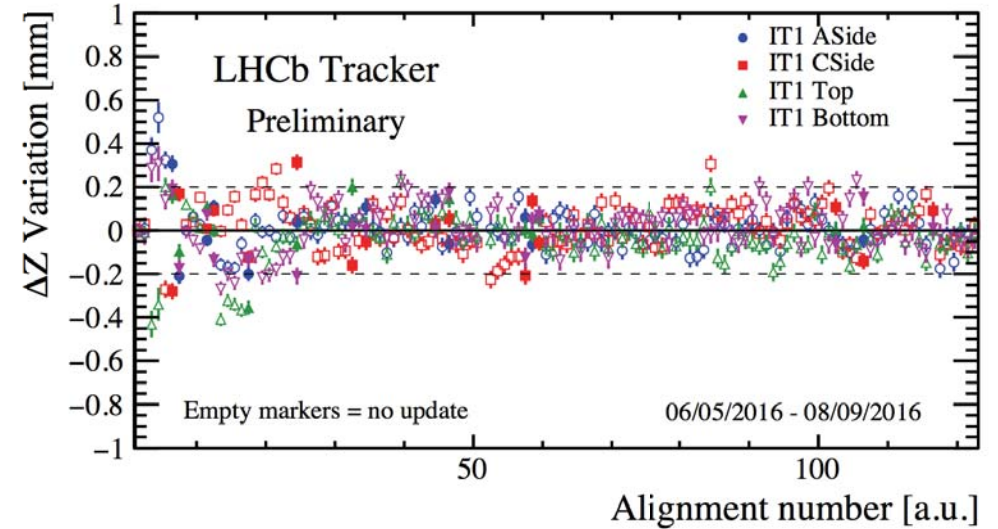
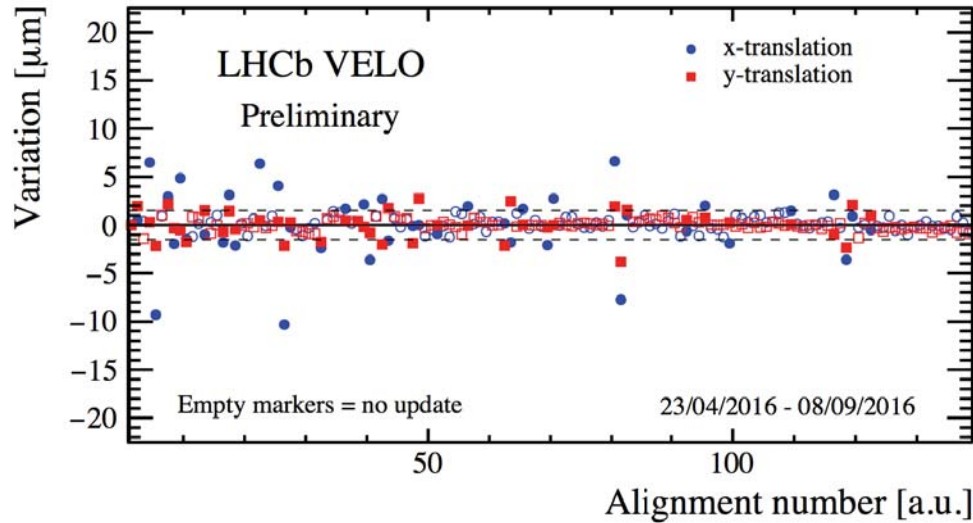

RICH alignment and calibration

- Spatial alignment of RICH mirrors
 - Automatic, every fill, ~ 1000 constants
 - Uses track fit information: cone axis = track direction

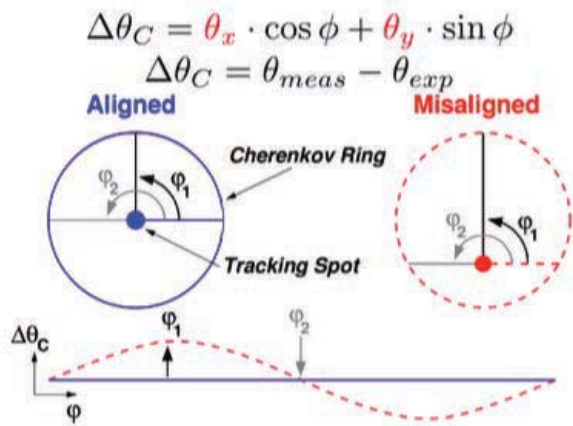

θ_{exp} angle estimated from track momentum and refractive index

Before mirror alignment

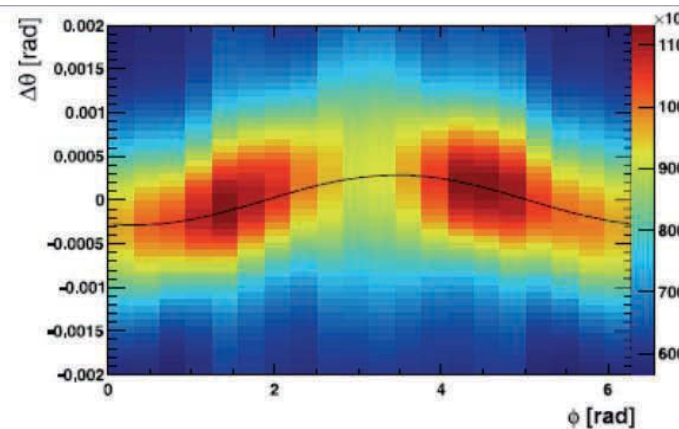

After mirror alignment

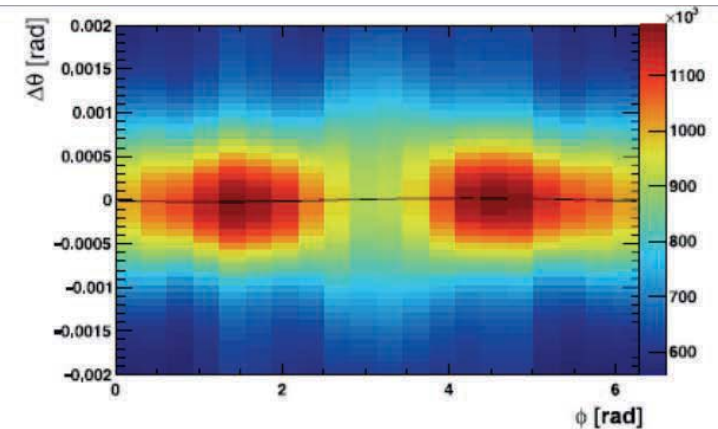

- Calibration of gas refractive index (2 parameters); depends on T, p and exact mixture composition
- HPD calibration (e.g. to correct for residual magnetic distortions), ~ 2000 constants

OT drift-time calibration

- OT is a gaseous straw-tube detector
- Position of the hits in the OT determined by measuring the drift time to the wire of the ionisation clusters created in the gas volume
- Drift time can be affected by variations in the time offset in the FE electronics
- Main effect due to variations of the difference between collision time and LHCb clock

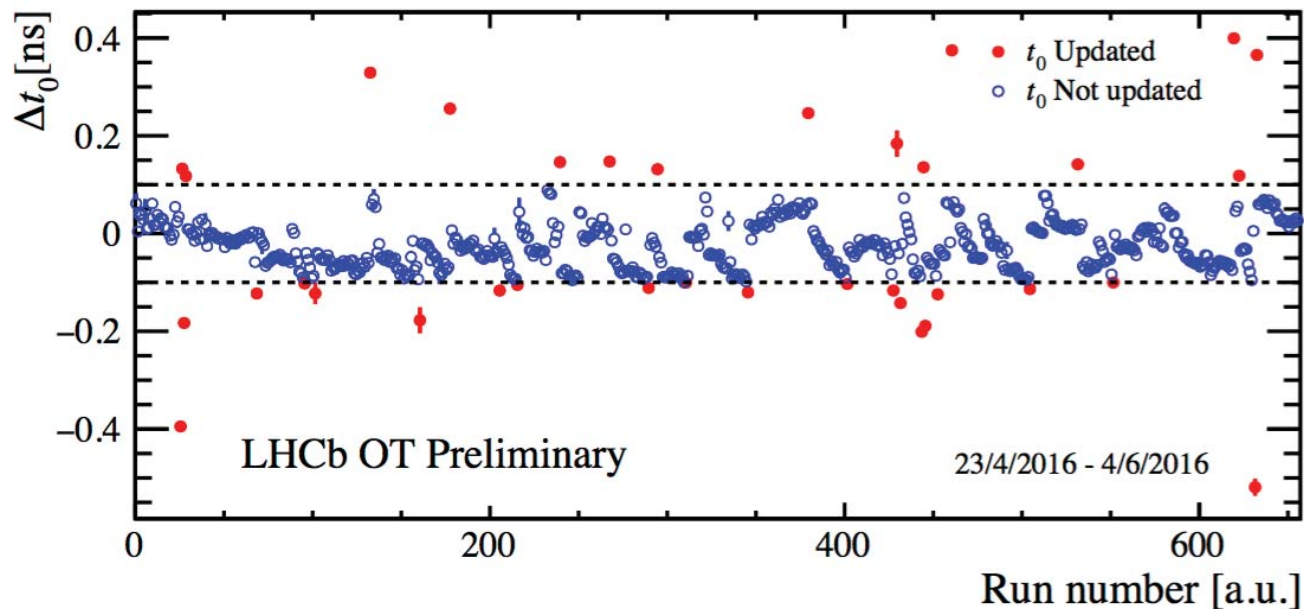
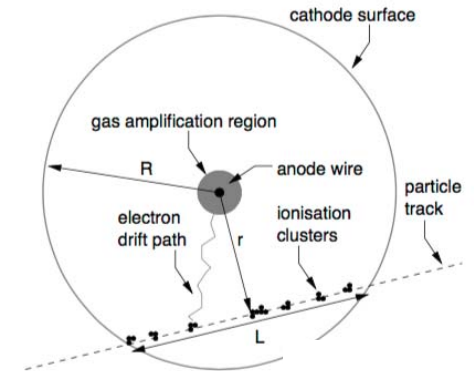

Evolution of LHCb trigger reconstruction

- Big effort to speed up the reconstruction and better exploit modern CPU architecture
- CacheGrind: Area \propto CPU cycles of trigger reconstruction software

2012 reconstruction

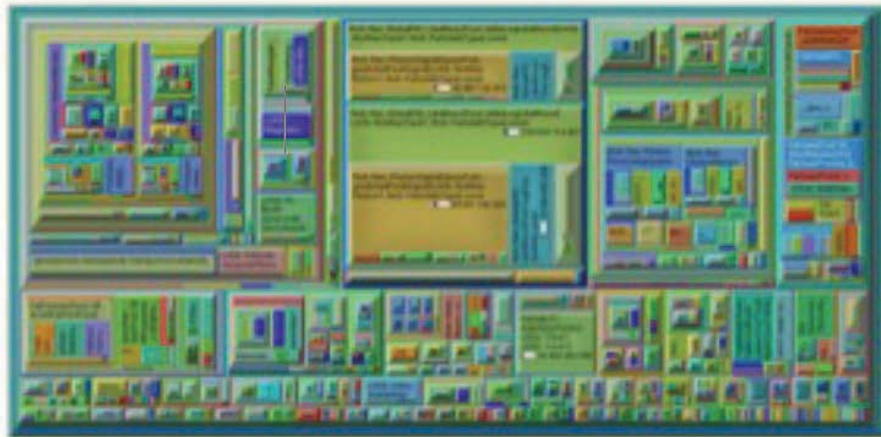

2015 reconstruction

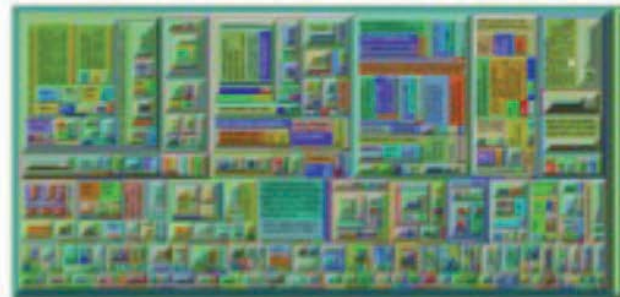

Performance: Run 1 Offline vs Run 2 Online

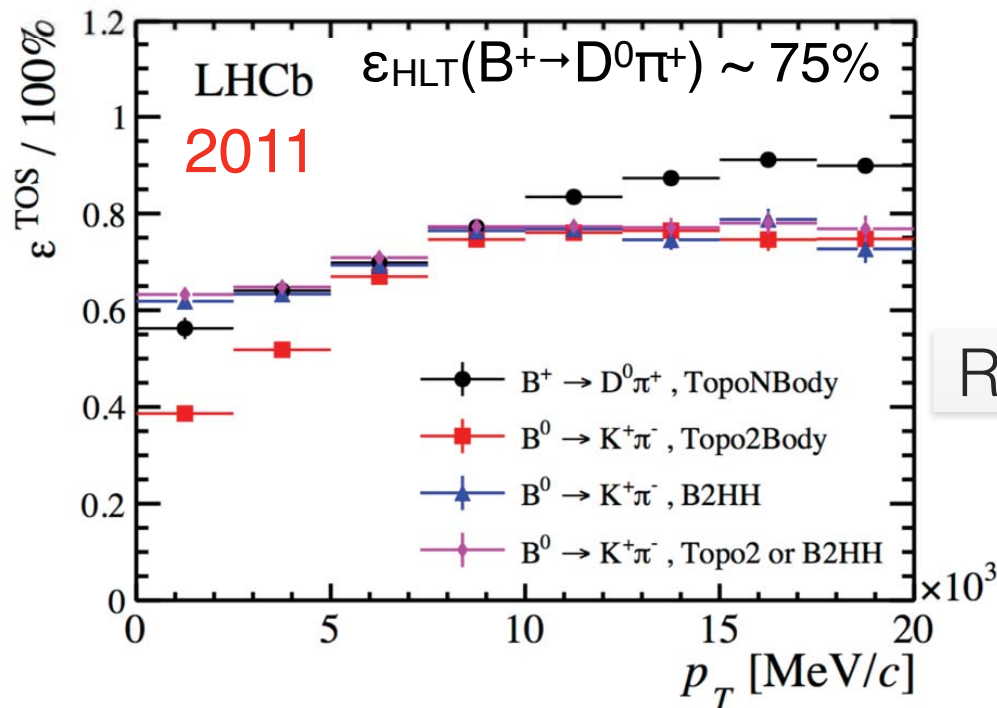
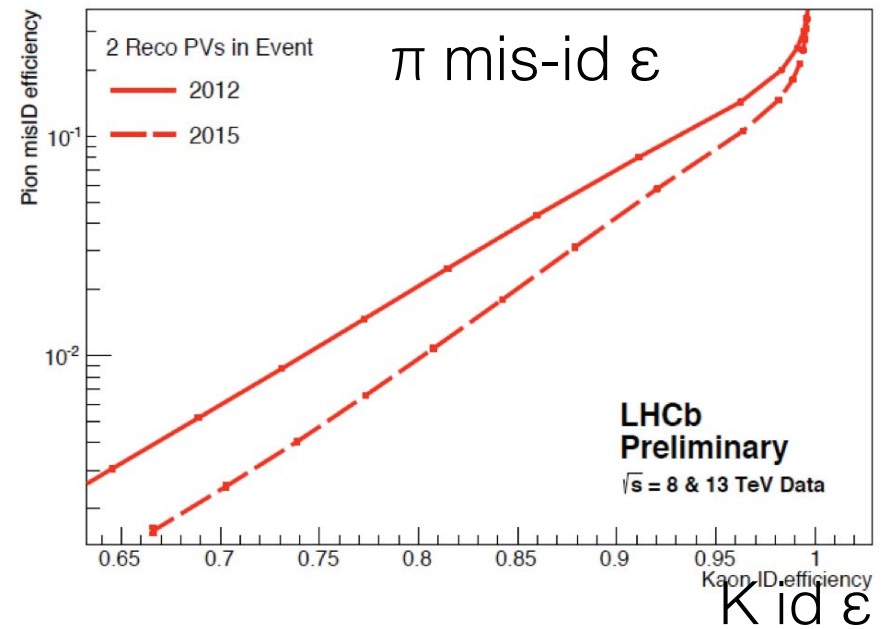
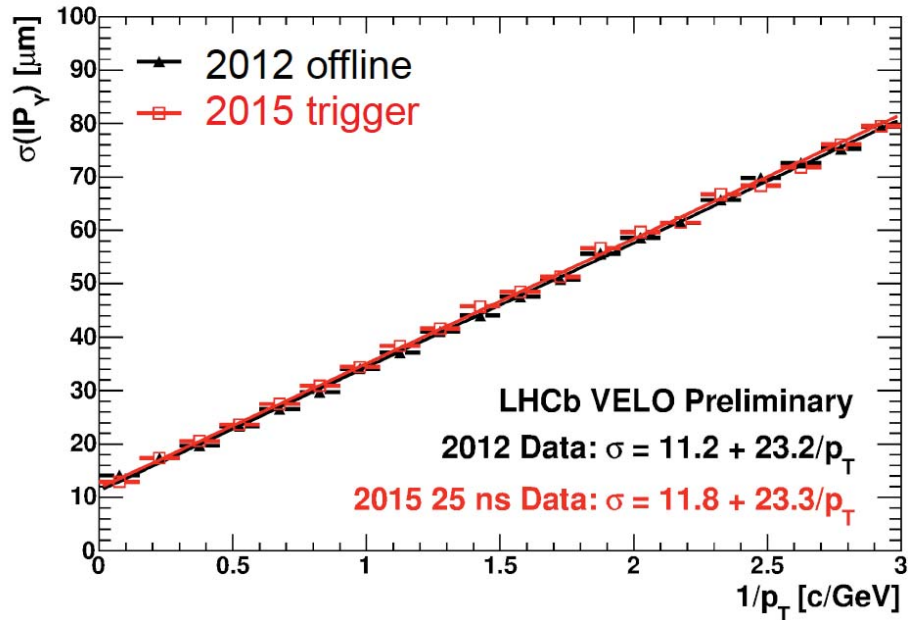

Run 2

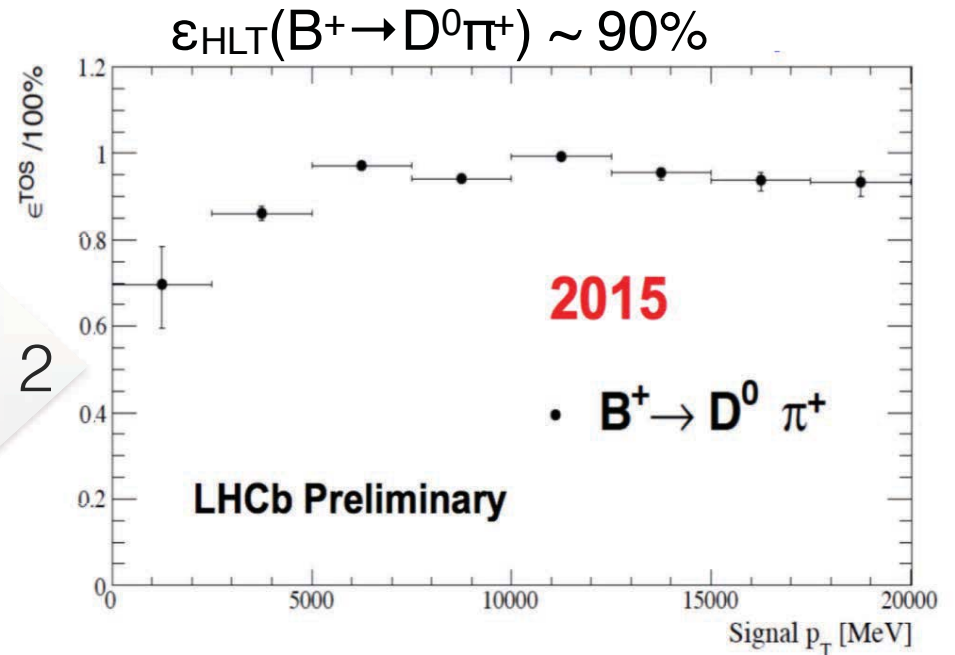

The Turbo stream

- With offline-quality reconstruction up-front, no need to reconstruct offline
- Can perform physics analysis directly @HLT level (“Turbo” stream)
 - Store full information of trigger candidates
 - Remove most of detector raw data
 - Save $\approx 90\%$ of space
 - Very quick turn around ~ 24 h
 - Smaller events \rightarrow analyse much higher rates
 - Charm analysis mostly based on signal candidates

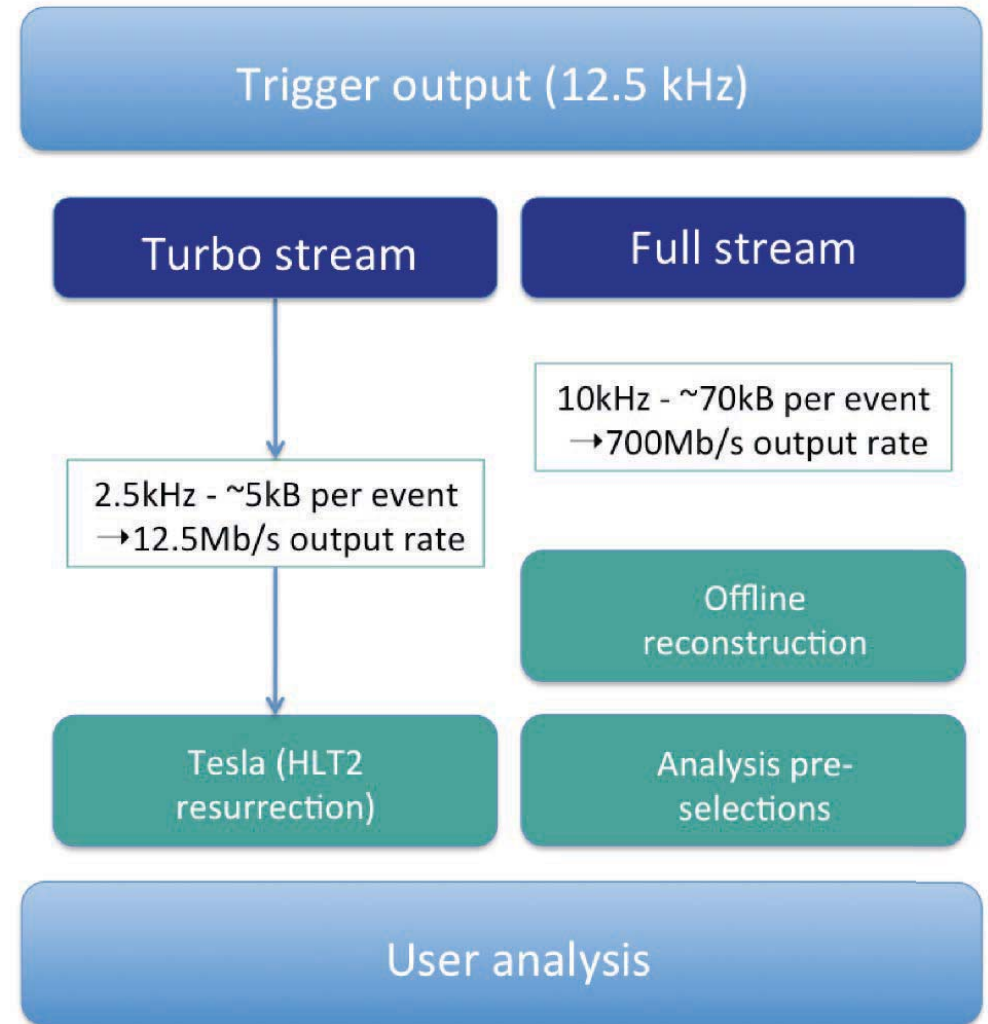

[arXiv:1604.05596](https://arxiv.org/abs/1604.05596)

2015 charm straight out of the HLT

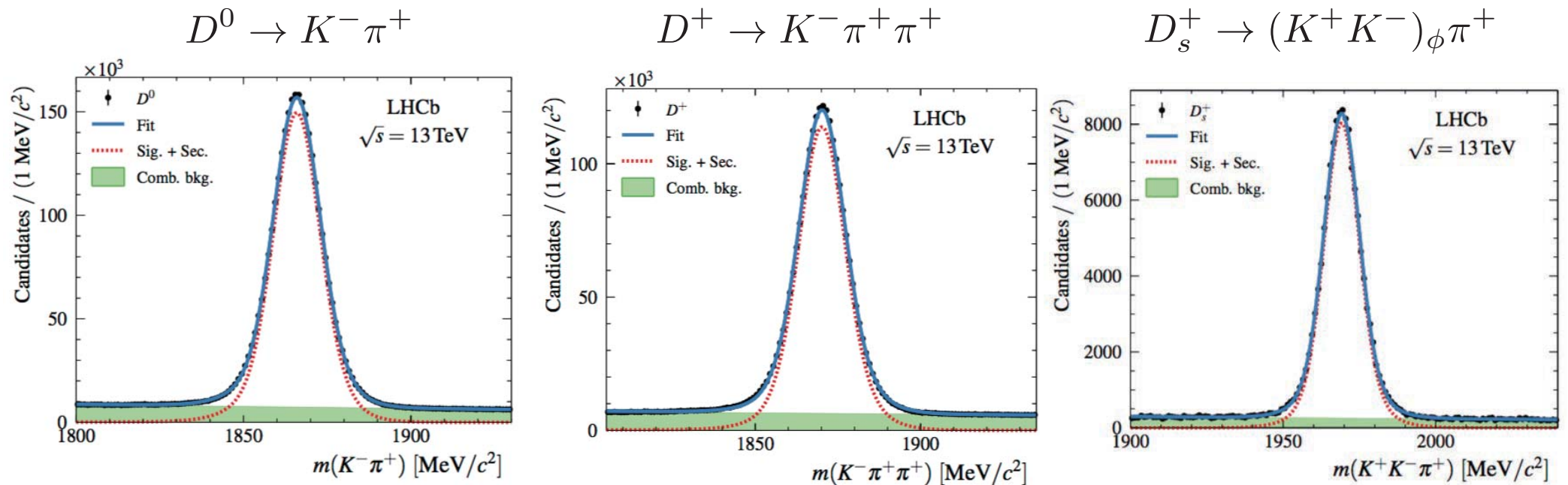

JHEP09 (2016) 013

- Measurement of prompt charm production cross-section @13 TeV
- Purity and resolution for charged particles equivalent to best Run 1 analyses!

J/ψ production @13 TeV

- Results presented after one week of data-taking!
- Use pseudo-lifetime to classify J/ψ from B vs prompt production

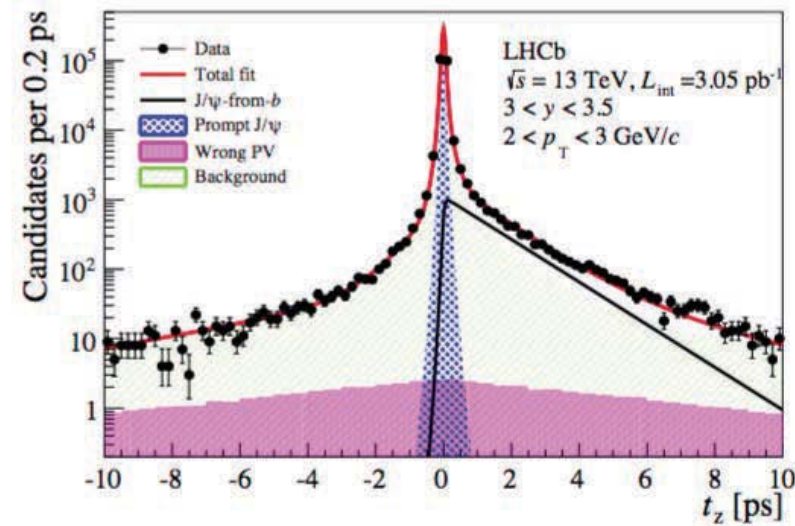
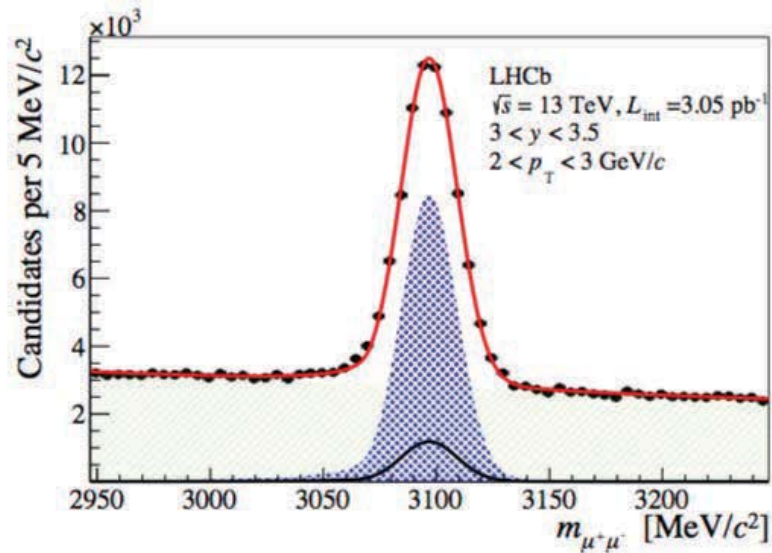
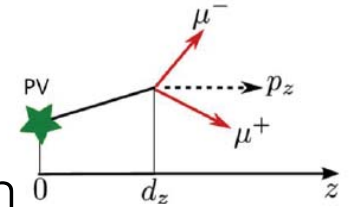

JHEP10(2015)172

$$\sigma(pp \rightarrow b\bar{b}X) = 512 \pm 2 \pm 53 \mu b$$

From Turbo to Turbo ++

Turbo candidate

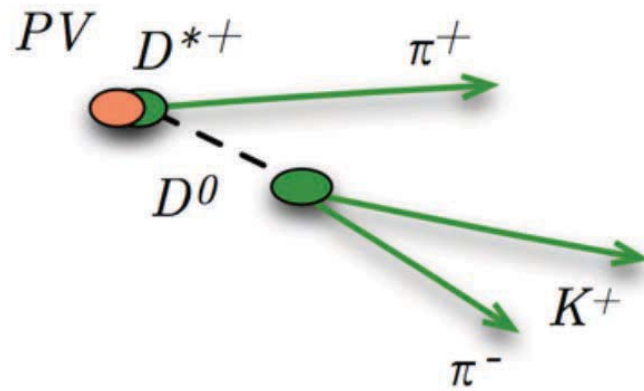

Turbo++ candidate

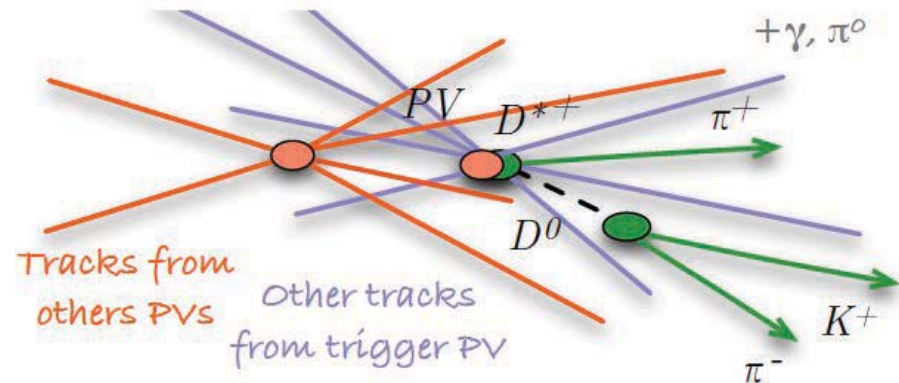

- Saves only objects selected by the trigger
- Output limited to standard set of variables



- Allows other reconstructed objects to be saved
- Allows creating and saving new variables (e.g. hits in a cone around a track) "à la carte", depending on physics analysis

- Turbo ++ becomes fatter (~40 kB/event), but we approach the flexibility to perform ~any type of physics analysis in real time
- In 2016, 150 out of 420 HLT2 'lines' were Turbo

Run 2 to Upgrade

- Run 2 serving as a demonstrator for the upgrade
- Two key components of upgrade selection deployed in Run 2:
 - Alignment & calibration in real time
 - Analysis with Turbo stream (reduced data format)
- The performance of a final analysis quality event reconstruction in real time crucial for processing large quantities of data
- The LHCb upgrade will see the Luminosity rise from $4 \times 10^{32} \text{ cm}^{-2} \text{ s}^{-1}$ to $2 \times 10^{33} \text{ cm}^{-2} \text{ s}^{-1}$ (x5)
- In addition, the L0 hardware trigger will be removed

L0 bottleneck

- Highly efficient for dimuon events
- For hadronic channels, any further increase in the rate requires an increase of E_T threshold \rightarrow trigger yield saturates with increasing luminosity leading to \sim constant signal yield

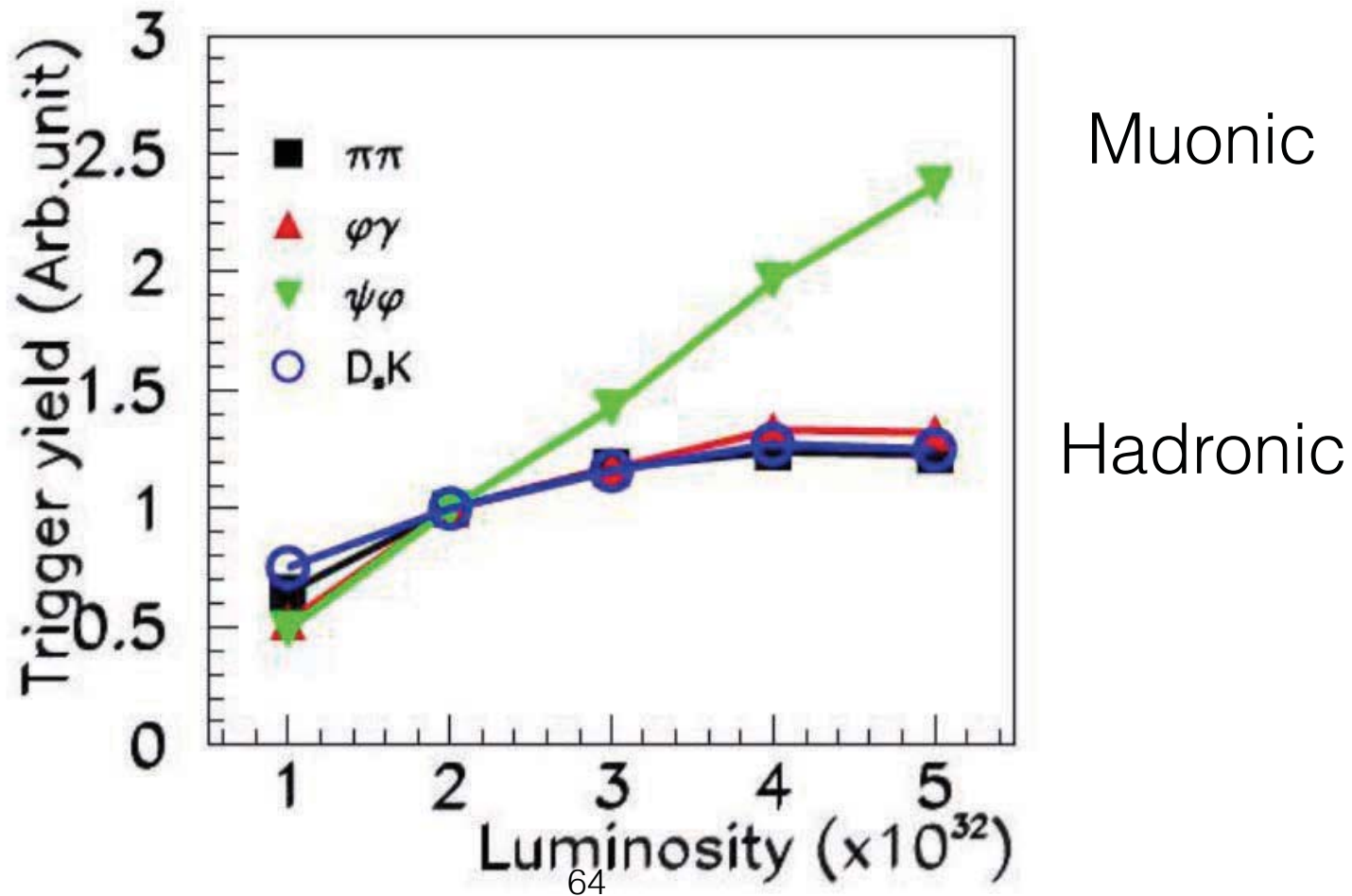

L0 bottleneck

- Highly efficient for dimuon events

- For hadronic decays, an increase in luminosity requires an increase in trigger rate

Remove the 1MHz L0 bottleneck and supply the whole event information at each level of the trigger →
Read the full event at 40 MHz and implement trigger in software

Trigger-less readout in the upgrade allows ~2 x higher efficiency for hadronic decays at 5 x higher luminosity

1 2 3 4 5
Luminosity ($\times 10^{32}$)

Run 2 to Upgrade

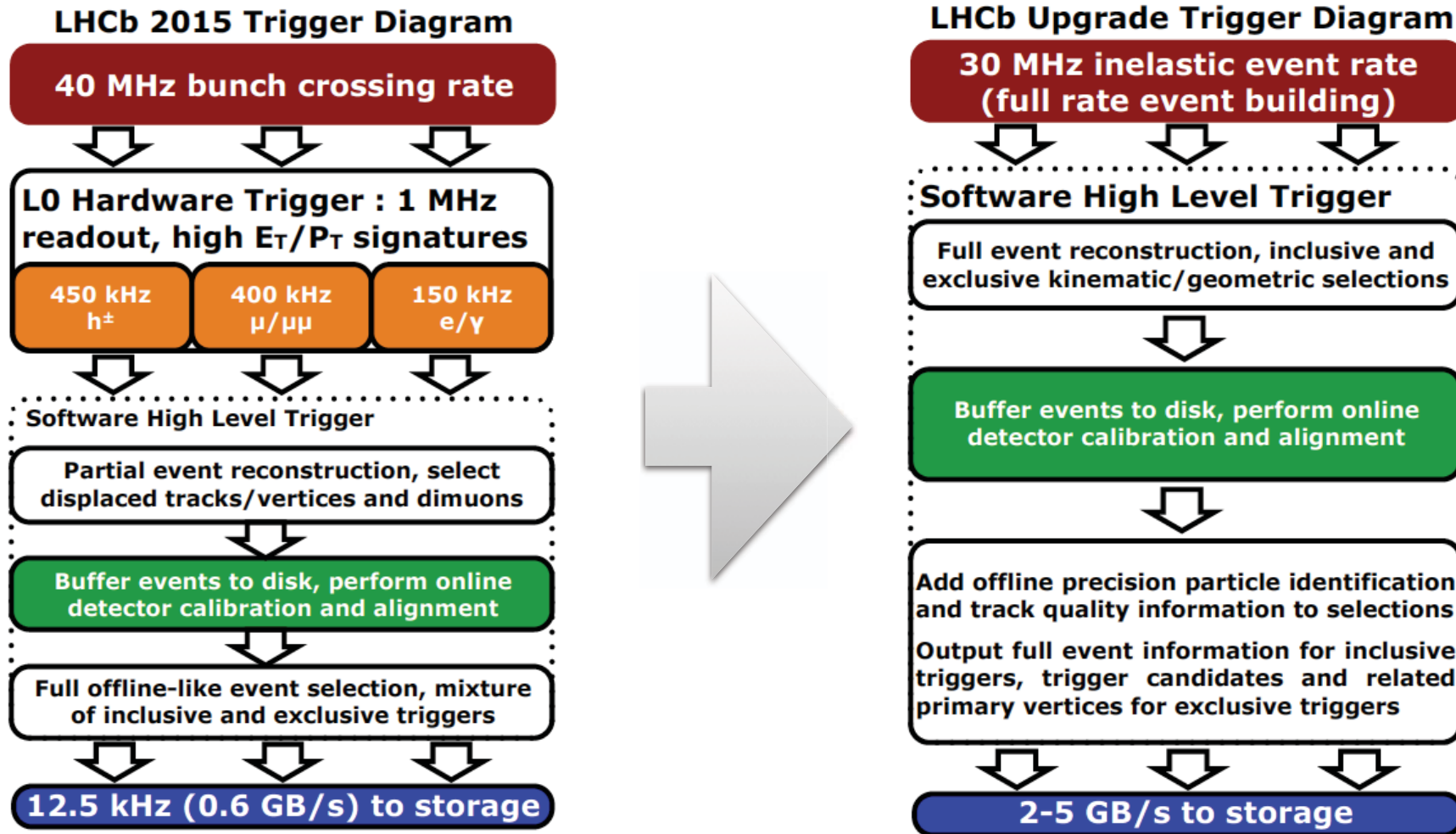

Network throughput

- Event filter farm will need to handle:
 - Event size (~ 130 kB)
 - 30 MHz (+10 MHz empty crossings)

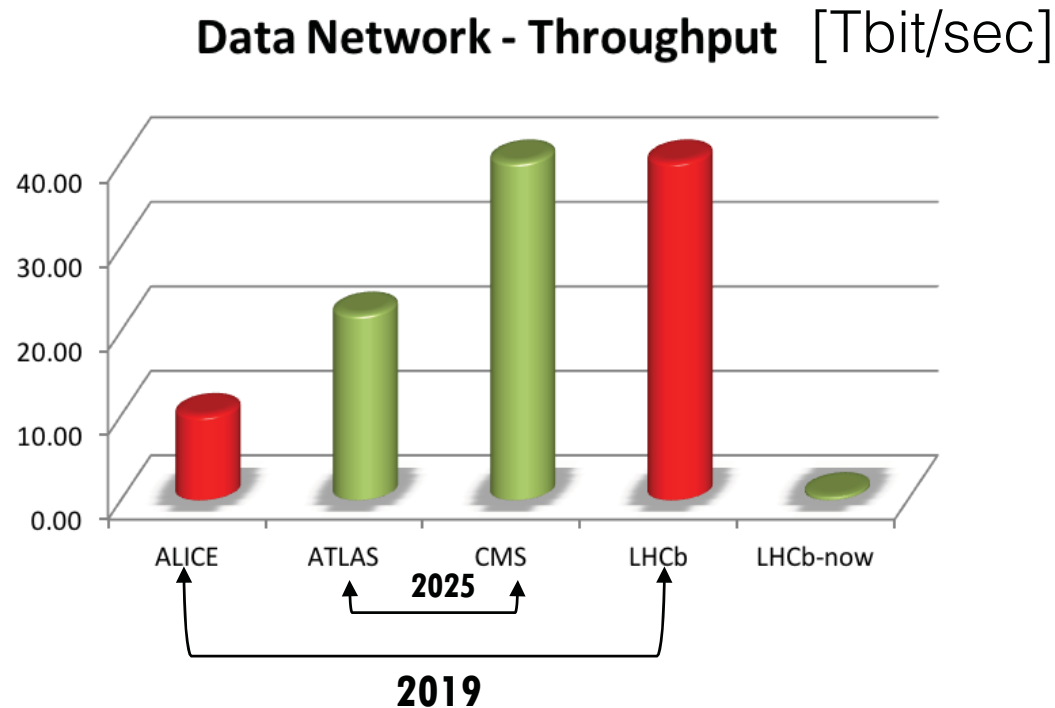

Upgrade conditions and implications for the trigger

- At $2 \times 10^{33} \text{ cm}^{-2} \text{ s}^{-1}$ every event will contain relevant signal:
 - 2% of the events will contain a reconstructible b-hadron (x 6 wrt Run 1)
 - 24% of the events will contain a reconstructible c-hadron (x 5)
 - 100% of the events will contain at least two displaced vertices from light long-lived hadrons (K^0 , Λ^0 , ...)

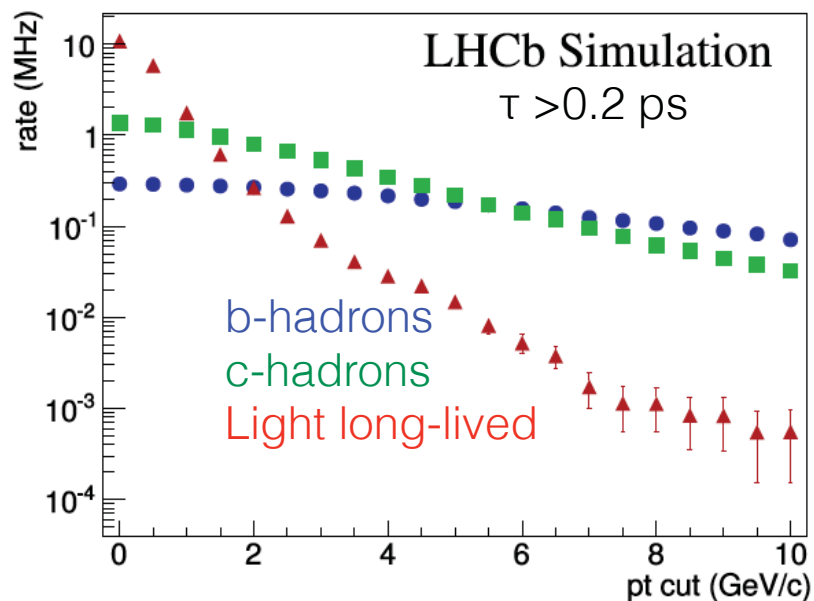

Particle type	Run I (kHz)	Upgrade (kHz)
b-hadrons	17.3	270
c-hadrons	66.9	800
Light long-lived hadrons	22.8	264

- Use of specific selection triggers will become increasingly necessary
 - Turbo model will become increasingly utilised
- Trigger should no longer separate signal from background but rather categorise different signals

Comput.Phys.Commun. 208 (2016)

LHC Schedule & LHCb

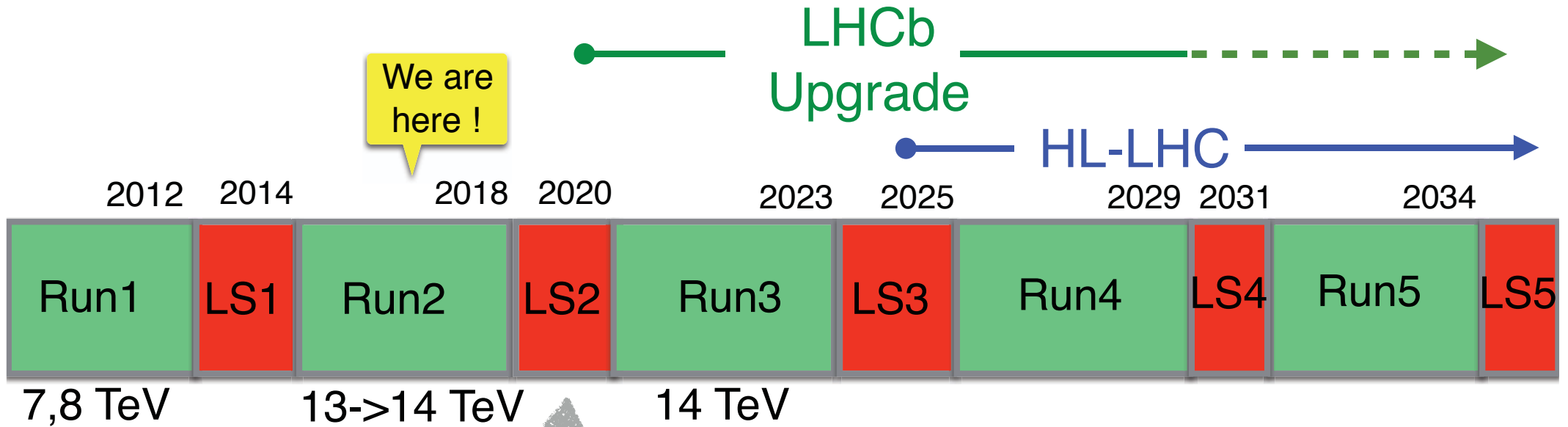

- LHCb is currently building its upgrade to be installed in LS2
- Aim: to collect 50 fb^{-1} at

$$\mathcal{L} = 2 \times 10^{33} \text{ cm}^{-2} \text{ s}^{-1}$$

	Integrated Luminosity (fb^{-1})	
	LHCb	ATLAS/CMS
Run 1	3	30
Run 2	8	100
Run 3	25	300
Run 4	50	...3000

LHCb Upgrade

- Requirements:

- 40 MHz readout
- Event selection performed by HLT software only
- $\mathcal{L} = 2 \times 10^{33} \text{ cm}^{-2} \text{ s}^{-1}$ (x 5)
 - 5.5 visible interactions/crossing
 - Higher track multiplicity (from $\sim \langle 70 \rangle$ to $\langle 180 \rangle$)

- Implications:

- New detector front-end electronics because of new readout requirement
- New HLT farm and network
- New trackers with finer granularity to reduce occupancy
- What is not changed needs to be consolidated to sustain higher Luminosity

The upgraded detector

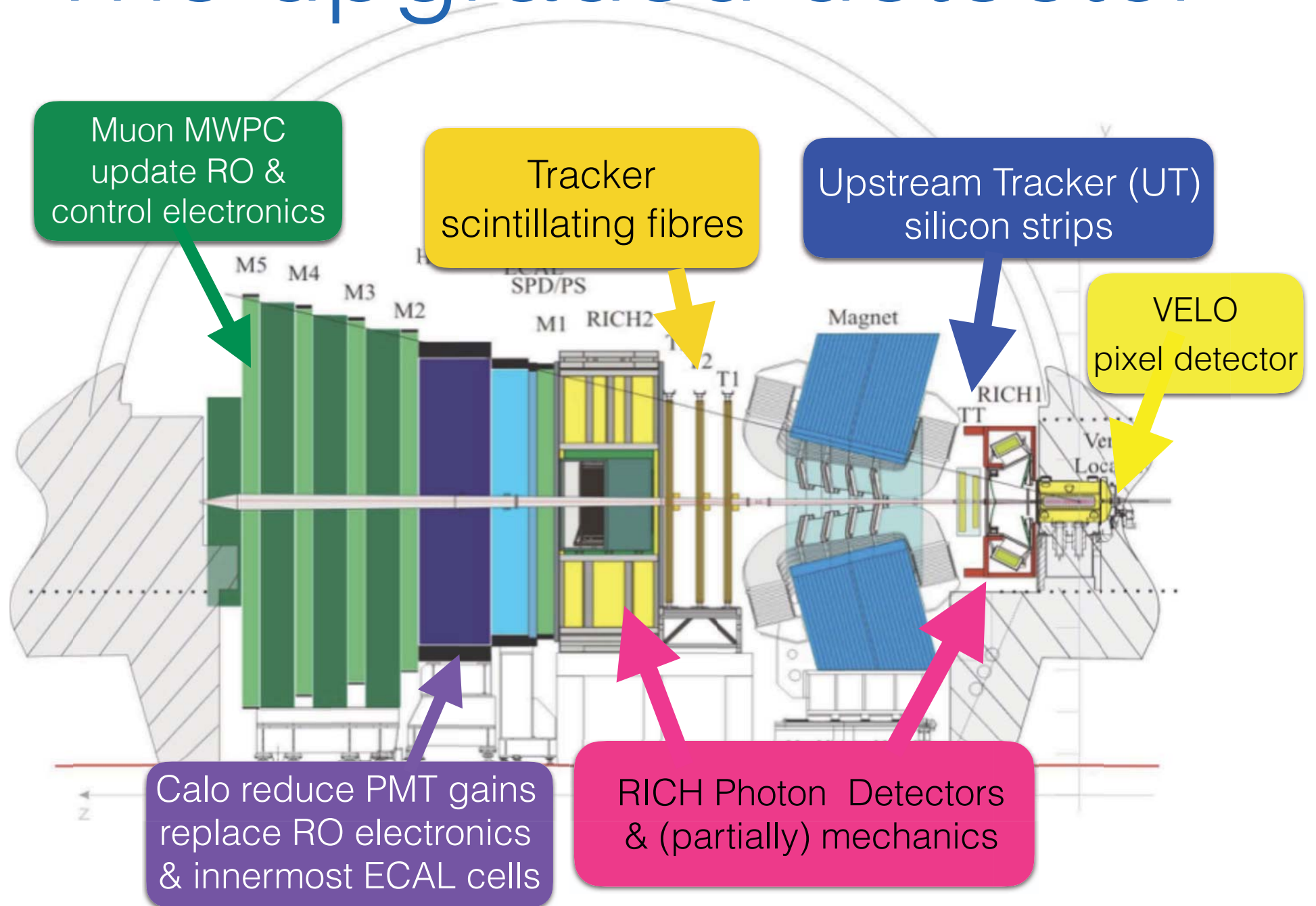



The upgraded VELO

Complete replacement of silicon sensors & electronics

- Silicon pixels ($55 \times 55 \mu\text{m}^2$) for higher granularity
- 26x2 modules in two retractable halves
- Reduced material
 - Sensor thickness reduced from 300 to 200 μm
 - RF foil enclosure from 300 to 200 μm
- Closer to the beam (8.2 mm \rightarrow 5.1 mm)
- New readout chip (VeloPix) designed specifically for VELO upgrade
- Must survive radiation dose $\approx 5 \times$ current VELO ($8 \times 10^{15} \text{ n}_{\text{eq}} \text{ cm}^{-2}$) highly non-uniform
- New cooling system: CO_2 cooling in micro-channel substrate

The upgraded VELO

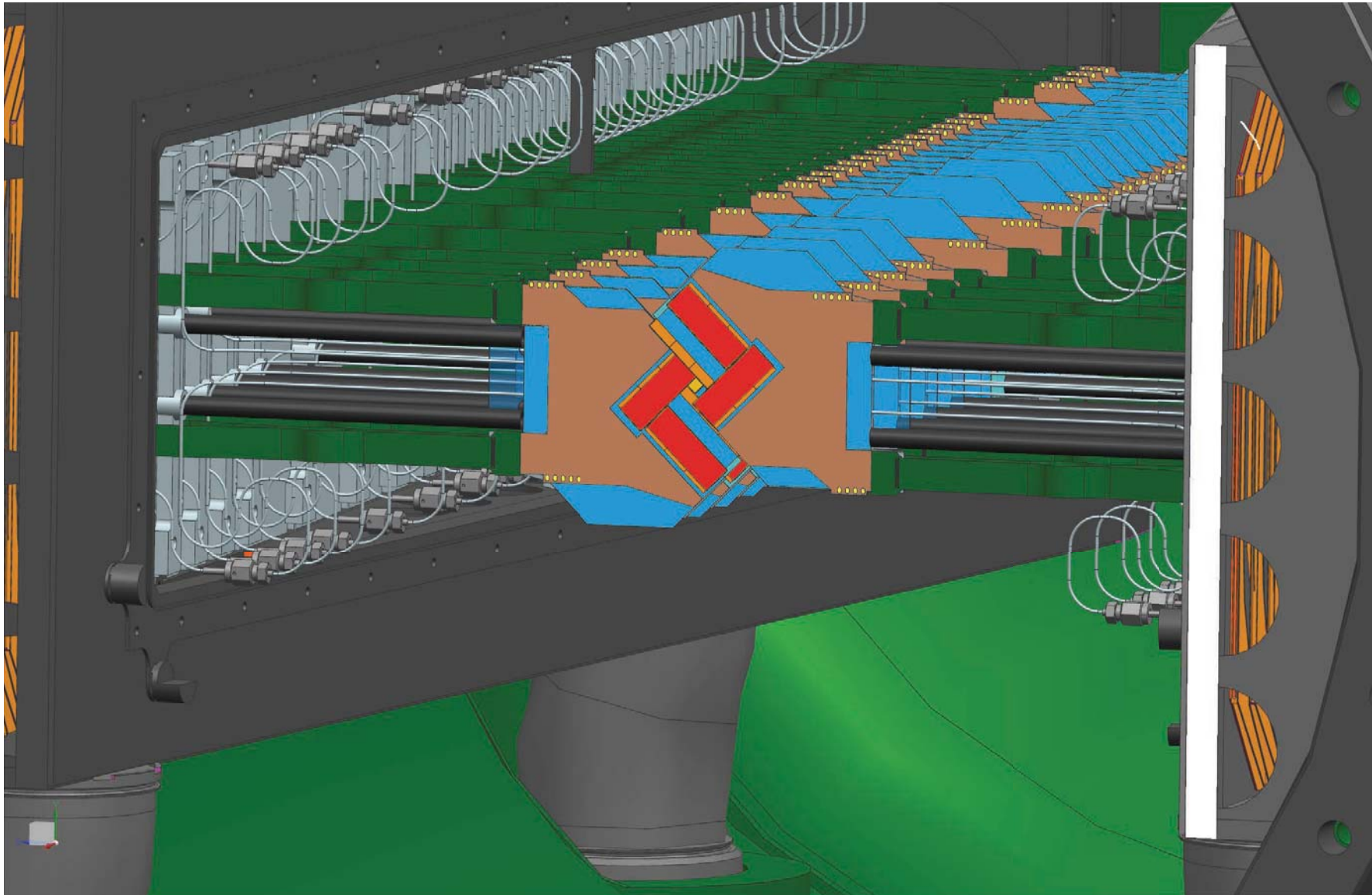

VELO modules

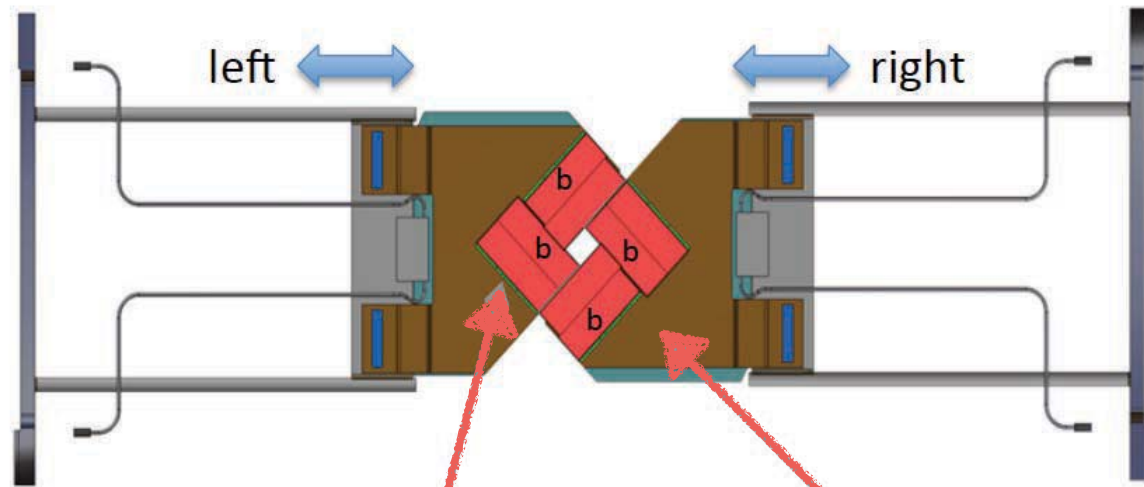

Half of the sensors are mounted on the back (b) to avoid gaps in acceptance

Four sensors per module, powered and read-out via hybrid boards and kapton cables, n-in-p (baseline)

Mounted on silicon substrate, etched with internal micro channel to provide CO₂ cooling

Each sensor (43 mm x 15mm) bump-bonded to three VeloPix ASICs

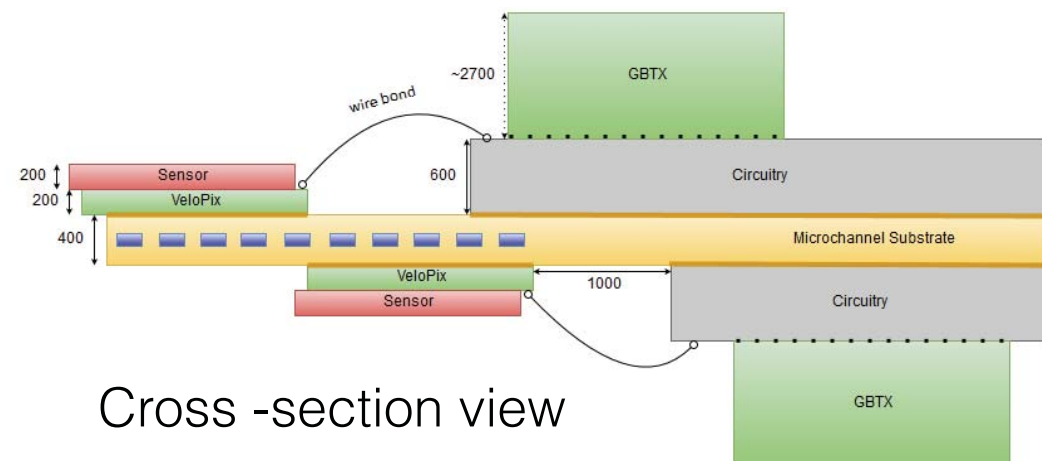

Cross -section view

VeloPix

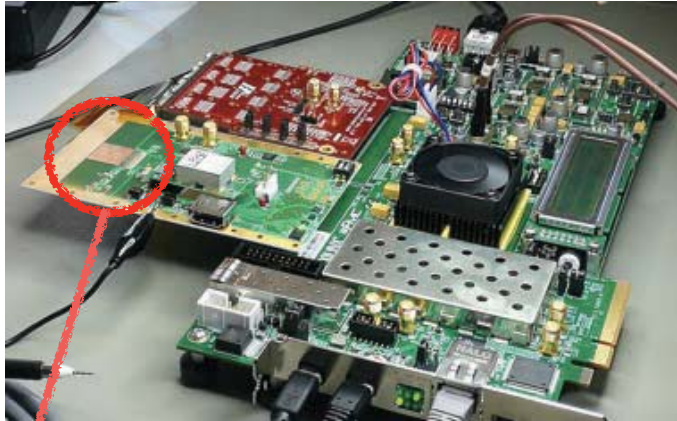

VeloPix: pixel readout chip

- 256 x 256 pixel matrix
- 130 nm technology
- Binary readout
- Extreme data rate
 - ~800 Mhits/s
 - ~20Gbit/s output bandwidth
- ~400 Mrad integrated dose

Sketch of
VeloPix
sensors

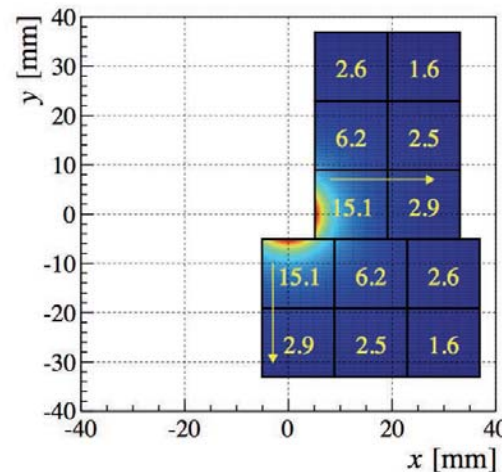
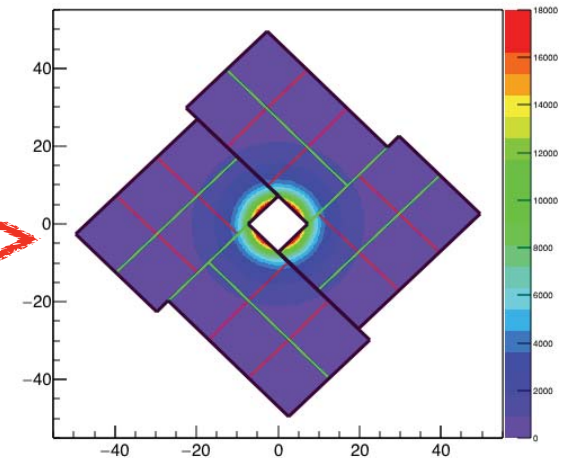

One module with
12 VeloPix Asics
showing data
rate in Gbit/s

First VeloPix received in September '16

Under test: everything so far behaving as expected

RF foil

- It separates VELO vacuum from LHC vacuum
- It suppresses heating due to strong wake-fields, because it allows a mirror current to travel parallel with the beam
- It shields the detector from high-frequency fields of the LHC beams

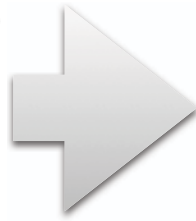

- Must accommodate module geometry
- Thermally and mechanically stable, radiation hard, conductive.....
- Must be thin - it dominates material in acceptance

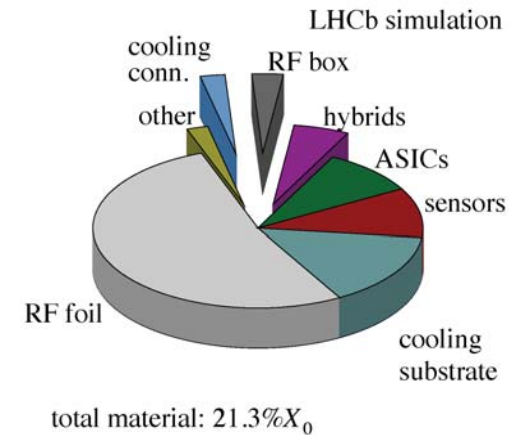
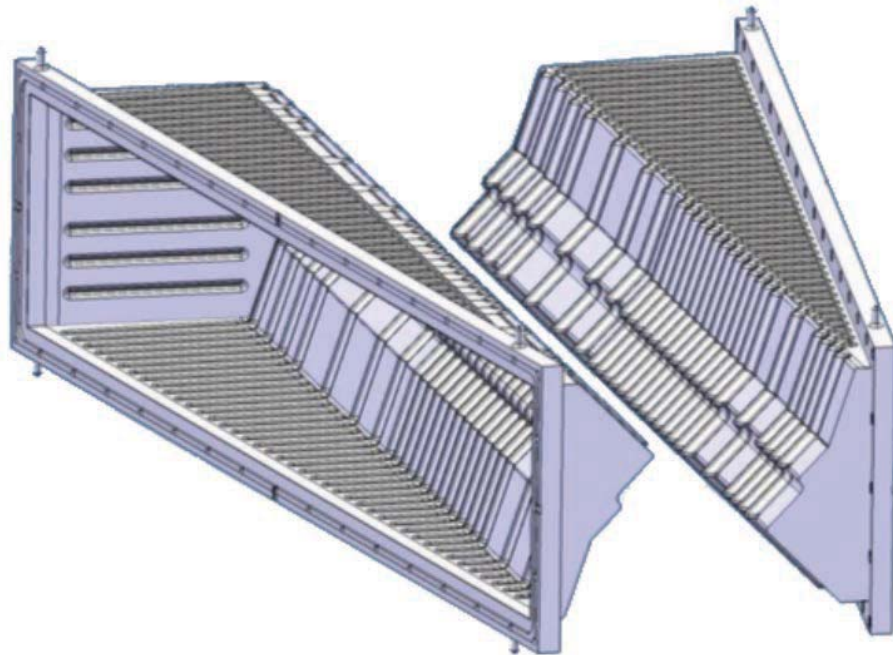

250 μm thick aluminium milled from solid block!
Corrugated to minimise material traversed before first hit

RF foil

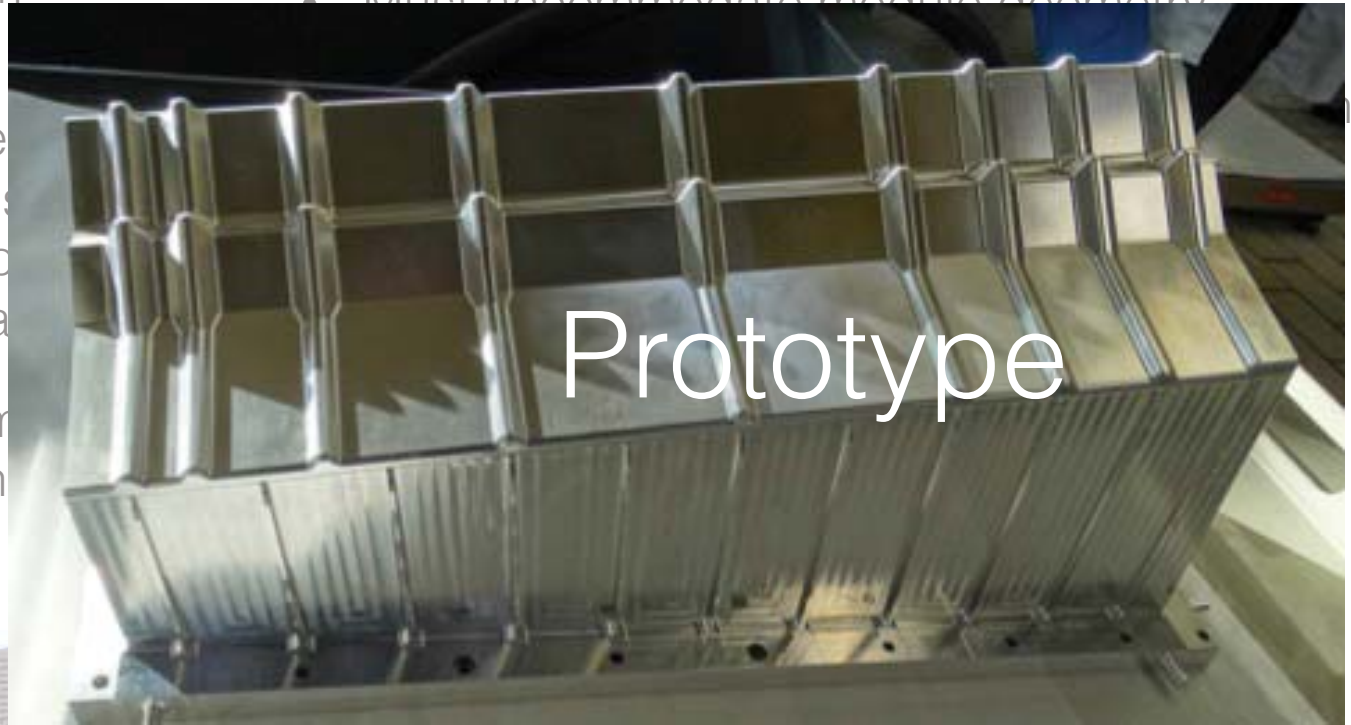

substrate

total material: $21.3\%X_0$



250 μm thick aluminium milled from a solid block!
Corrugated to minimise material traversed before first hit

Cooling

- Upgraded VELO will dissipate 1.6 kW of power
- Sensors need to be kept at -20°C to mitigate radiation damage
- Need cooling system with minimal material that can reach the ASICs close to the beam and works in vacuum
- Solution: Two-phase CO_2 (liquid/vapor mix) circulating in micro-channels embedded within the silicon substrate

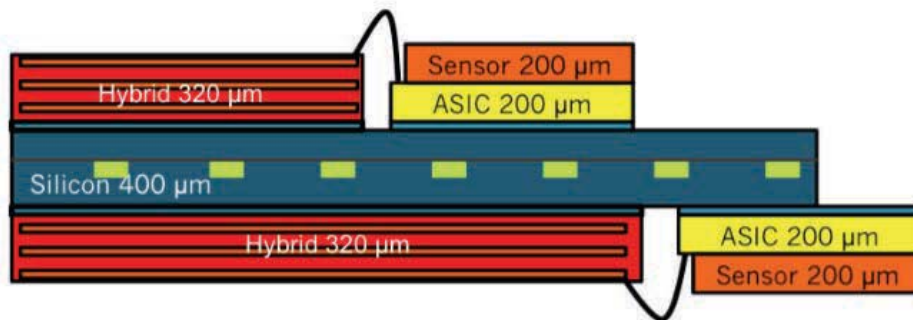

- Plan B based on cheaper, less risky, standard technology: steel capillaries glued on ceramic plate - slightly worse performance

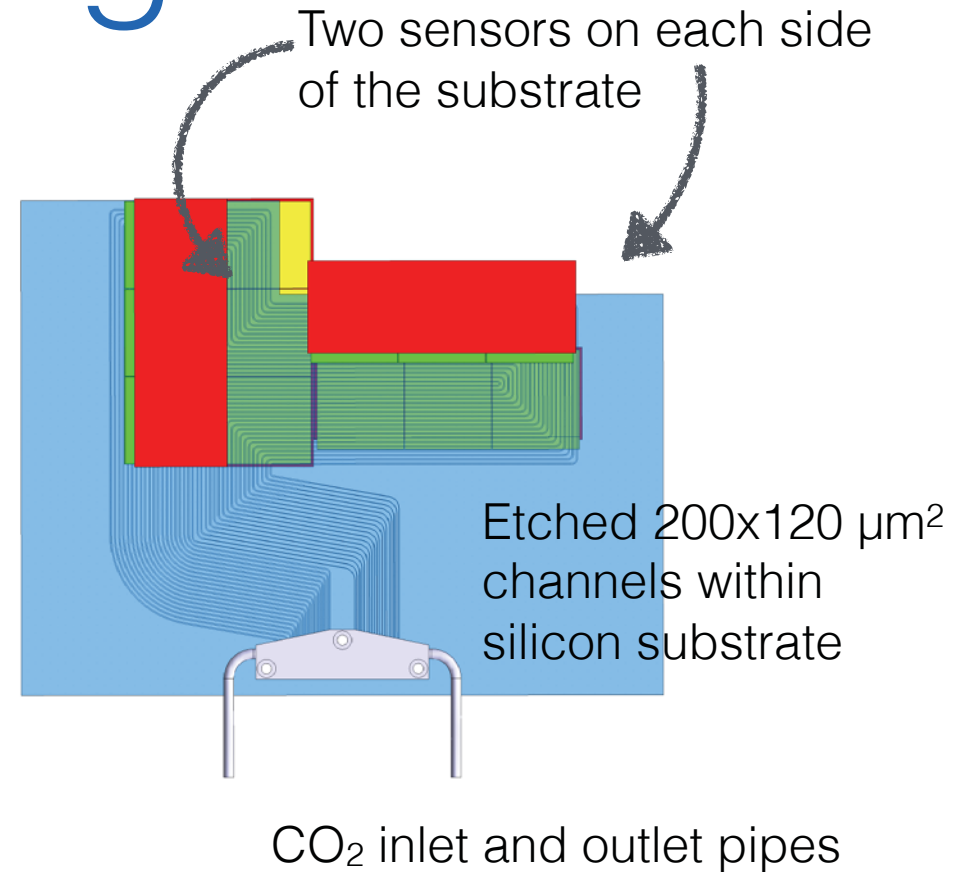

VELO physics performance

- Tested using full simulation, with realistic detector model
- Upgraded VELO surpasses current VELO performance even with higher multiplicities

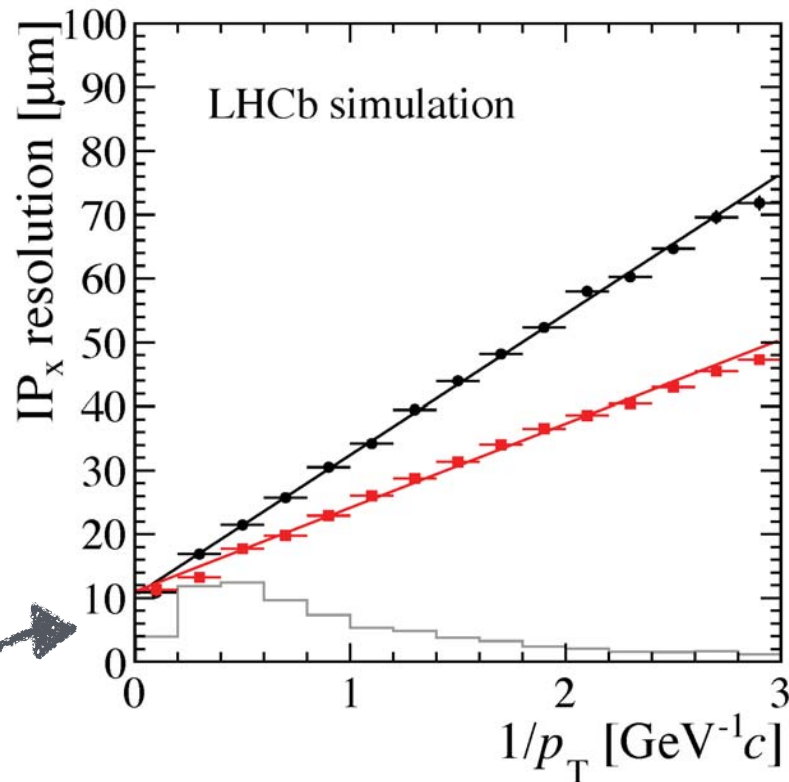

IP resolution:
Current VELO in upgrade conditions
Upgraded VELO

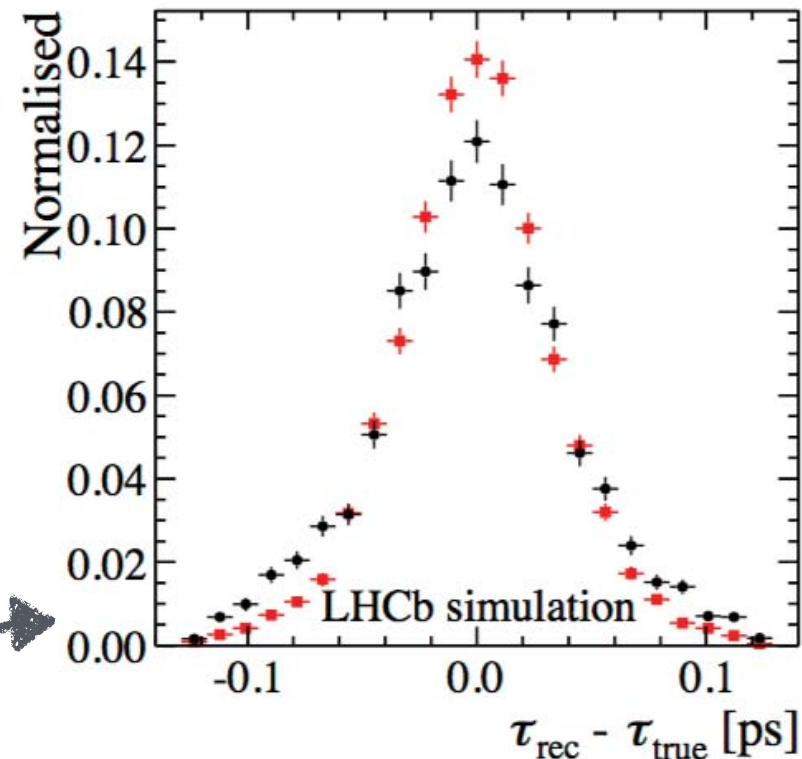

Decay time resolution for $B^0 \rightarrow K^{*0} \mu^+ \mu^-$ decays :
Current VELO in upgrade conditions
Upgraded VELO

Upstream Tracker (UT)

- Reconstruct downstream particles decaying after the VELO, children tracks from $K_S \rightarrow \pi^+ \pi^-$, $\Lambda \rightarrow p \pi^-$

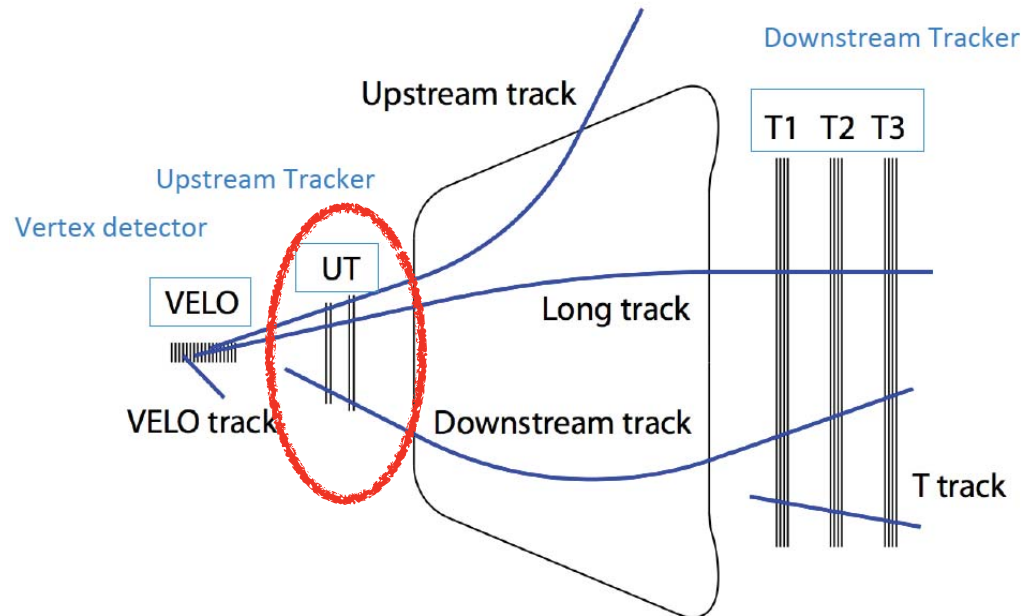

Ex: $\overline{B}^0 \rightarrow J/\Psi K_S^0$
>70% of the events reconstructed with downstream tracks

- Reconstruct low-momentum tracks deflected out of T-station acceptance
- Improve momentum resolution for long tracks (most used tracks for physics analysis, best vertex and momentum resolution)
- Reduce fraction of “fake tracks” (wrong matching between VELO and T stations) by factor two to three for typical VELO track multiplicity
- Dipole fringe field gives VELO+UT momentum resolution of $\sigma(P_T)/P_T \sim 15\%$ allowing fast tracking to be used in the trigger
- Eliminate gaps in acceptance and cover smaller angles wrt beam axis
- Finer segmentation and less material

Upstream Tracker (II)

- 4 planes of silicon strip sensors (vertical, -5° , $+5^\circ$, vertical) of varying granularity constructed using 'staves' (16 or 18/plane)
- The UT stave (1.2m x 10 cm) is main mechanical element
- The stave provides a stiff, low mass core on which sensors ($10 \times 10 \text{ cm}^2$), hybrids and readout cables are mounted. It also includes an integrated cooling channel (-5°C , by evaporative CO_2)

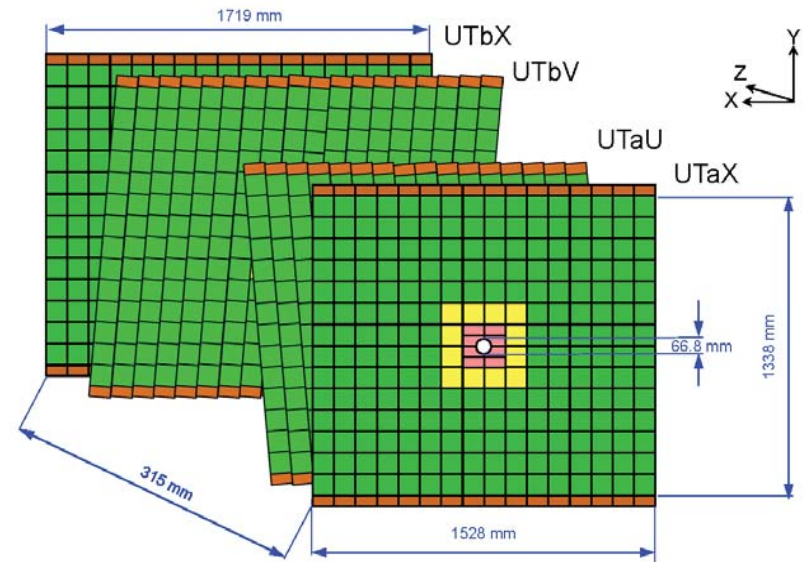

98 mm 190 μm 512 strips	98 mm 95 μm 1024 strips	49 mm 95 μm 49 mm 95 μm
--	--	--

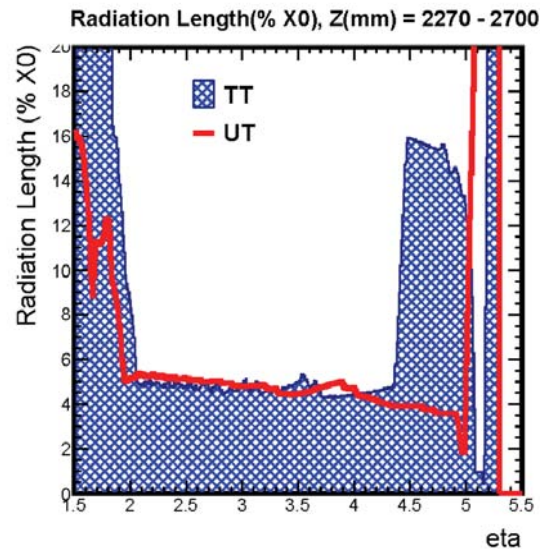
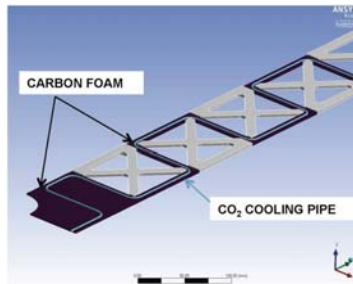

Cross -section view

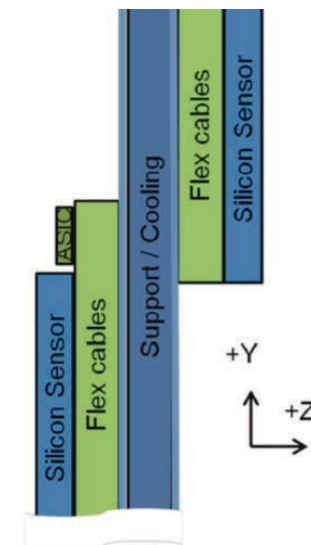



SciFi: the Downstream Tracker

- **Sci**ntillating **Fi**bre Tracker: three stations composed of four detector layers (vertical, -5° , $+5^\circ$, vertical) covering the whole acceptance: $5 \times 6 \text{ m}^2$

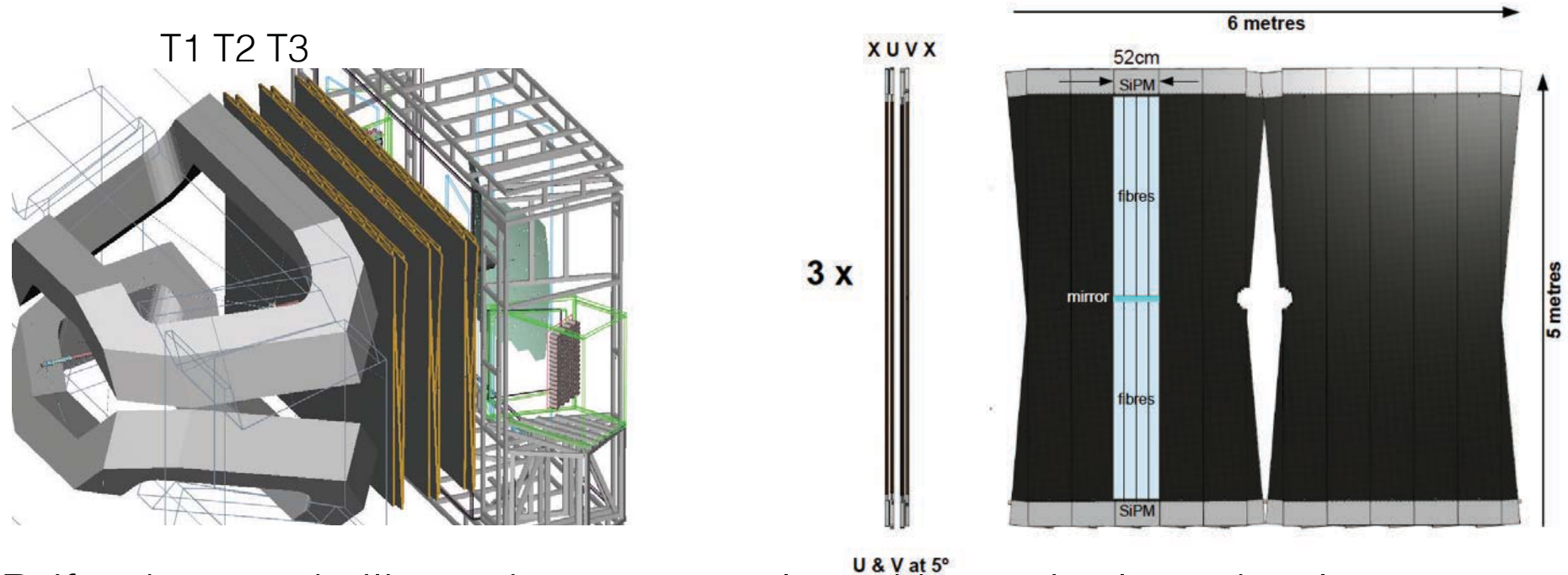

- Drift tubes and silicon detectors replaced by a single technology
- “mat”: 6 layers of 2.5 m long scintillating fibres with $\varnothing 250 \mu\text{m}$
- Total active surface $\sim 360 \text{ m}^2 \sim 11'000 \text{ km}$ of fibres
- Resolution better than $100 \mu\text{m}$
- Low material budget: $\sim 1\% X_0$ per layer
- Radiation hardness (up to 35 kGy for fibres near beam pipe in T1)

From single fibres to a tracking system

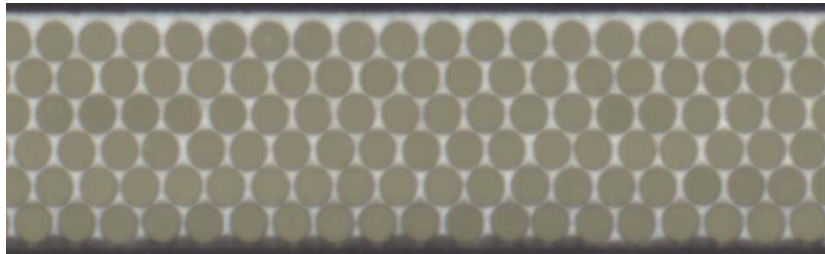

Scintillating fibres arranged in a matrix of 6 layers of fibres with $\varnothing 250 \mu\text{m}$ and $275 \mu\text{m}$ pitch



From single fibres to a tracking system

Front view of scintillating fibres in a mat

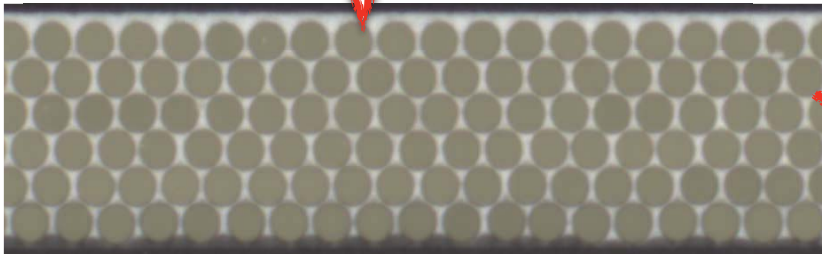

Fibre mat:

- 242 x 130 cm²
- 8 km of fibres/mat
- Covered by light tight foil
- Mirror at far end to enhance light yield
- 1200 fibre mats to be produced



From single fibres to a tracking system

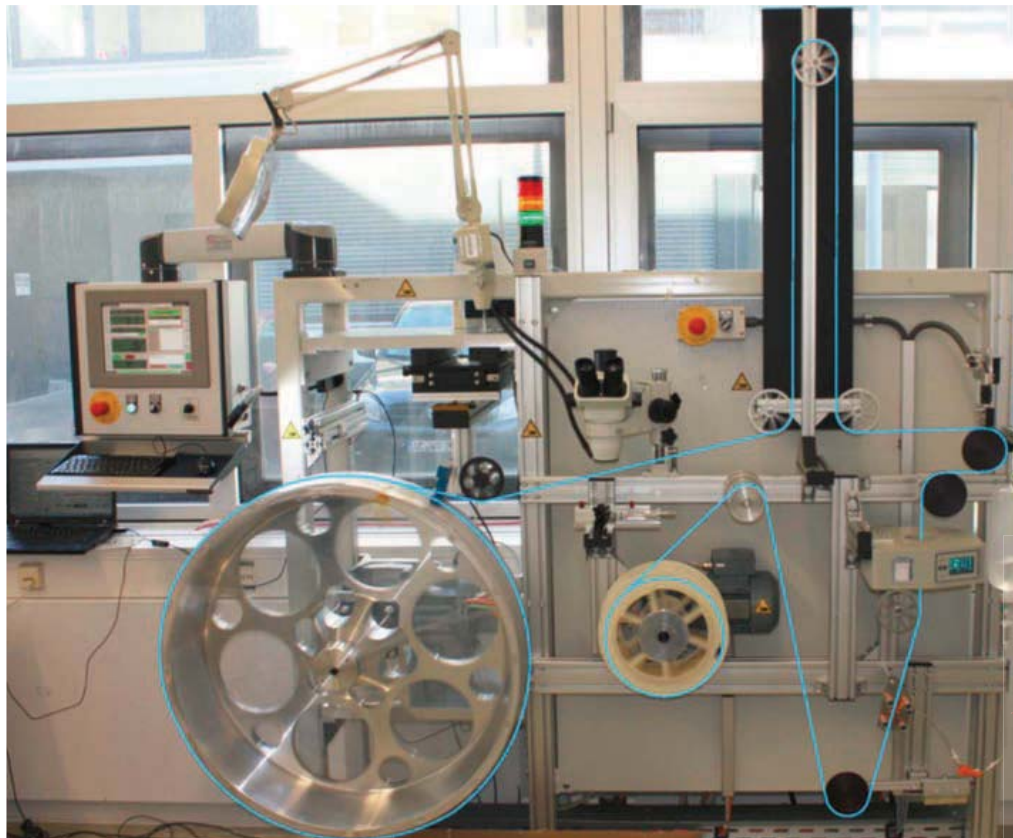

Extensive fibre QA @CERN

- all ~11'000 km of fibres tested
- bump detection & removal, shrinking larger bumps to a diameter of ~350 μm
- light yield & attenuation length measured, ...

Fibre mat winding @ 4 winding centres

- winding & gluing of 6 layers of fibres
- optical cuts, quality control

“Debumping” of fibres

- Bumps with a diameter $< 350 \mu\text{m}$ only create a local distortion and are ~acceptable. Larger bumps are a problem.
- Developed a fully reliable and automatic procedure to shrink larger bumps down to $\sim 350 \mu\text{m}$

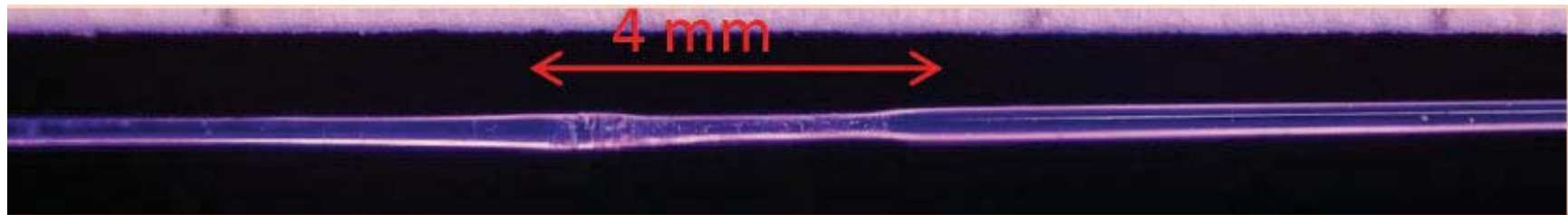
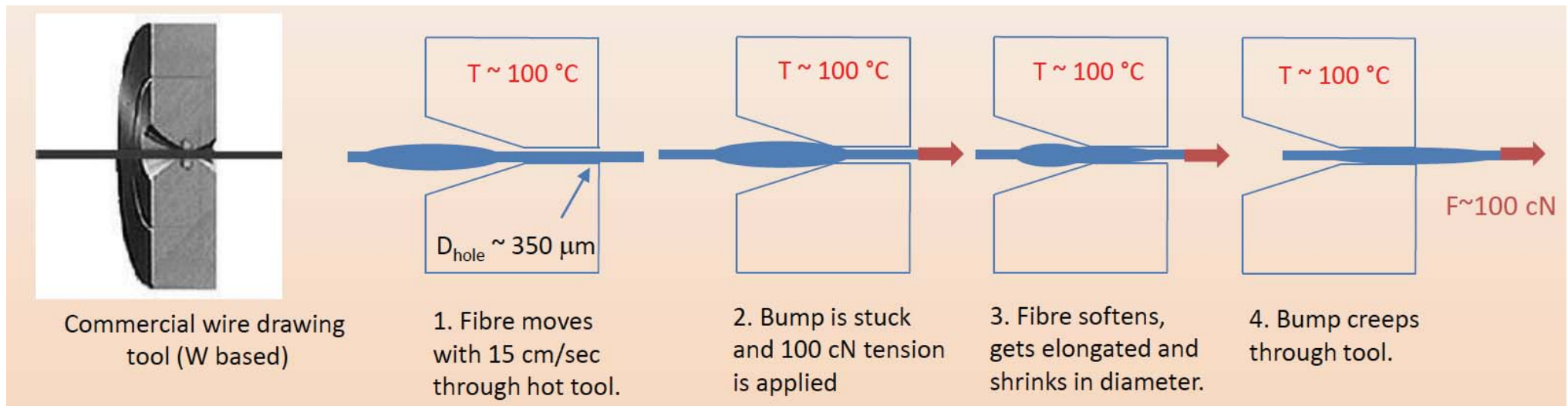
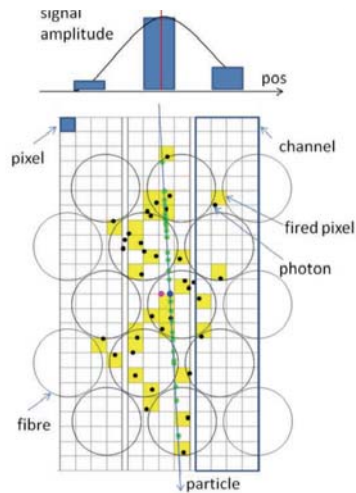
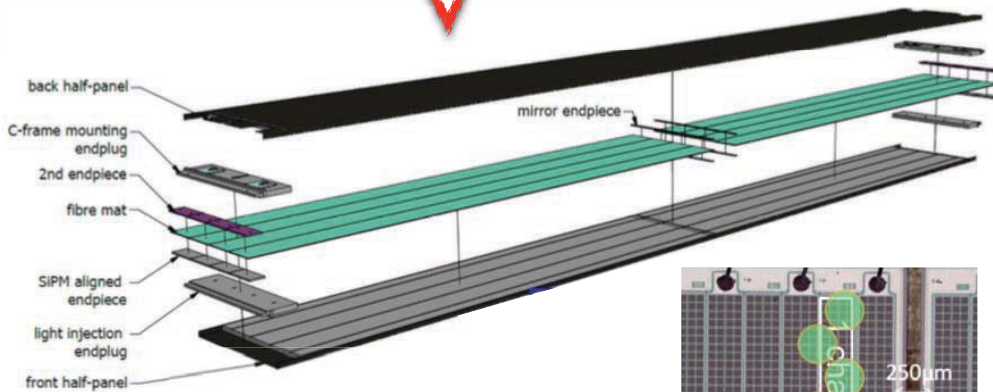

Photo of a shrunk bump. $D_{\text{max}}/D_{\text{min}} = 337 / 251 \mu\text{m}$.

From single fibres to a tracking system

8 mats are assembled into a module
(144 modules in total)

Challenge: alignment of fibres and
mats to $\sim 60 \mu\text{m}$



$$\sigma(x) \sim 80 \mu\text{m}$$

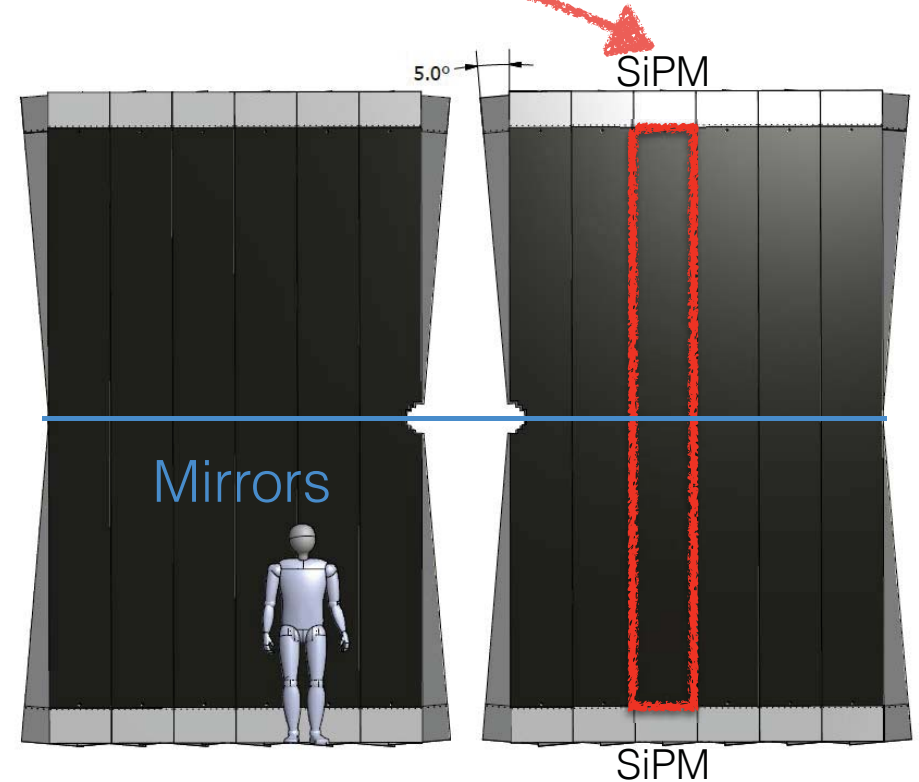
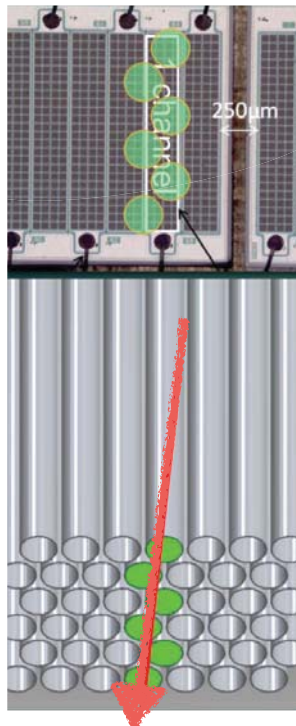

Fibres read by custom-made Silicon Photomultipliers (SiPMs)

Will be operated at -40°C to limit radiation-damage effects

Global tracking performance

- Work on algorithms still ongoing, current performance similar to that of Run 1:

	Upgrade pileup~5	Run 1 pileup ~1
“ghost track” rate	15%	15%
Efficiency		
Long tracks p>5 GeV	94%	97%
b-hadron children p>5 GeV	96%	97%

S.Hansemann-Menzemer
LHCC In-depth review, 23-5-2016

RICH detectors

- Philosophy: re-use as much as possible existing mechanical and optical components. However, optical layout of RICH1 modified to increase image of Cherenkov rings and reduce occupancy → increase radius of curvature of spherical mirrors by $\sqrt{2}$
- Pixel chip encapsulated in each photodetector (HPDs) limited to 1 MHz → replace the HPDs with commercial multi-anode photomultipliers (MaPMTs) with external 40 MHz readout electronics

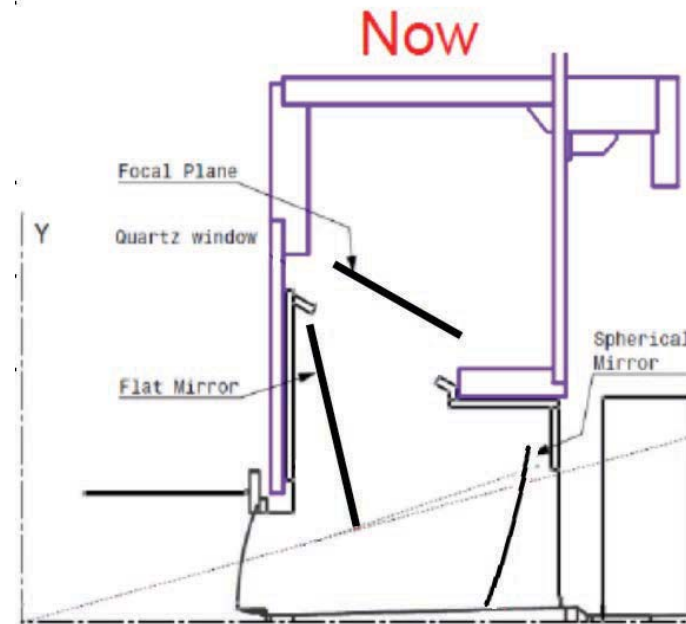

Elementary cell:
4x8x8 channels with
pixel size 2.9x2.9 mm²

magnetic field
shielding

89

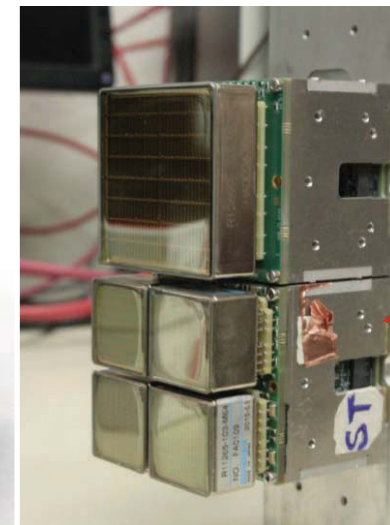
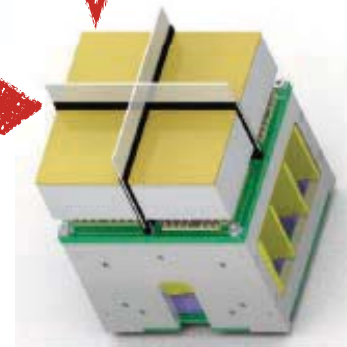

Outer
region
of R2

R1 &
inner
region
of R2

RICH detectors

- Philosophy: re-use as much as possible existing mechanical and optical components. However, optical layout of RICH1 modified to increase image of Cherenkov rings and reduce occupancy → increase radius of curvature of spherical mirrors by $\sqrt{2}$

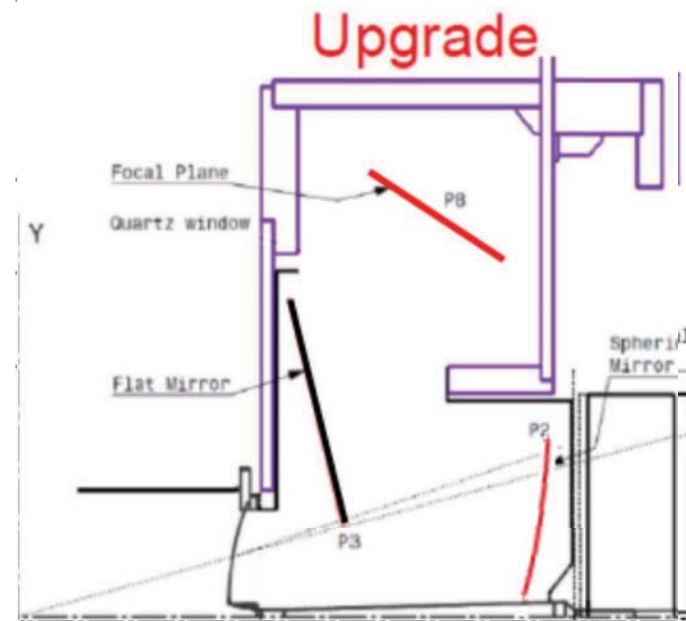

- Pixel chip incapsulated in each photodetector (HPDs) limited to 1 MHz → replace the HPDs with commercial multi-anode photomultipliers (MaPMTs) with external 40 MHz readout electronics

Elementary cell:
4x8x8 channels with
pixel size 2.9x2.9 mm²

magnetic field
shielding

90

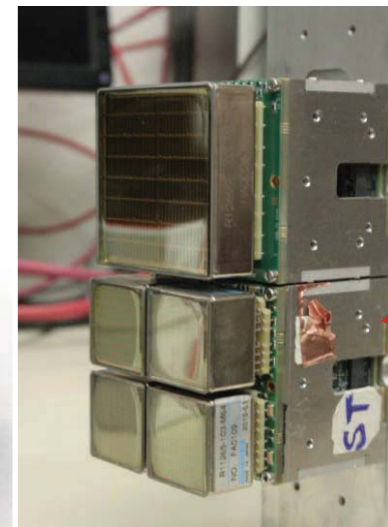
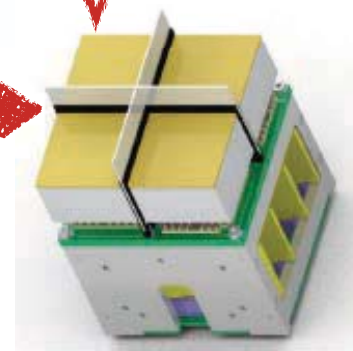

Outer
region
of R2

R1 &
inner
region
of R2

RICH PID performance

PID performance as a function of momentum

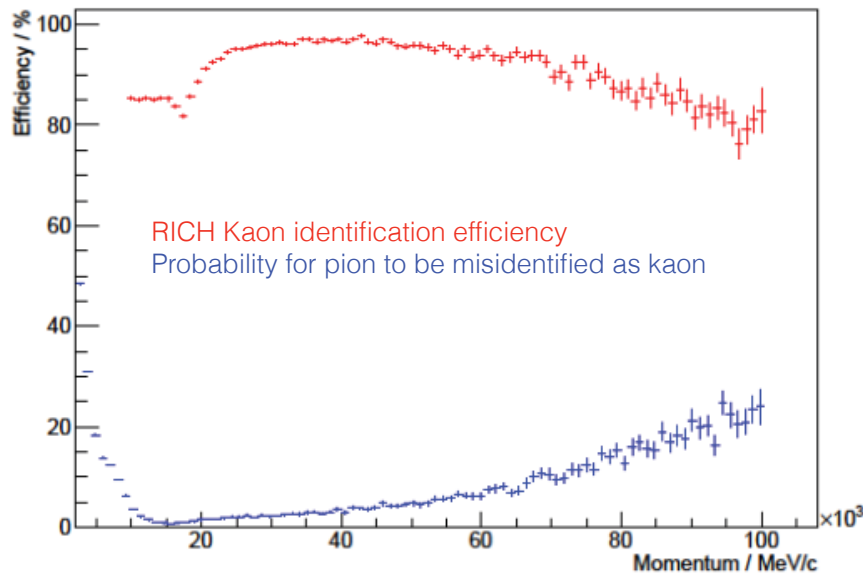

Rich Kaon identification efficiency

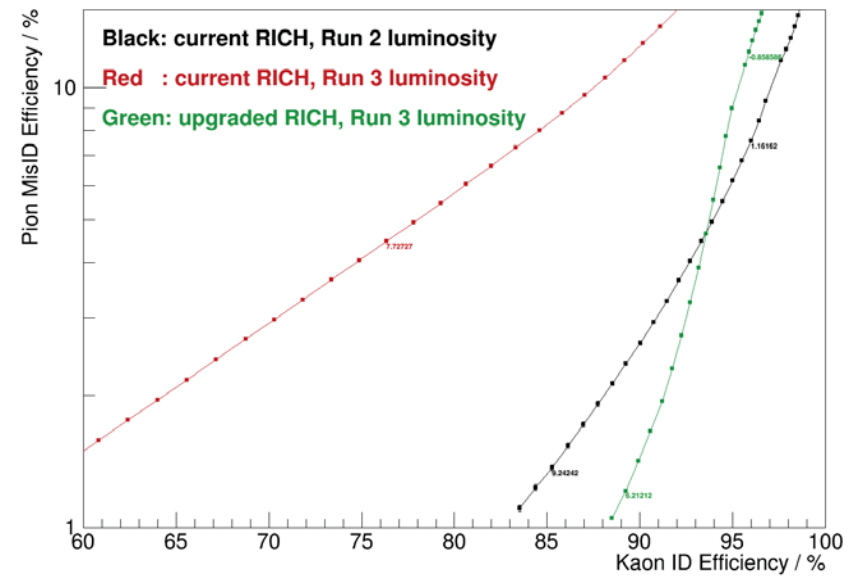

RICH-2016, talk by S. Easo

- Improved performance for upgrade configuration !

Calorimeters

- New design of FE electronics - must compensate for gain reduction of the PMTs by factor 5 (to avoid faster ageing due to higher Lumi)
- SPD/PS will be removed, as their main use is in the L0 trigger (only small effect on photon id)
- Modules will survive first period of upgrade operation. For the ECAL innermost cells replacement not needed till LS3

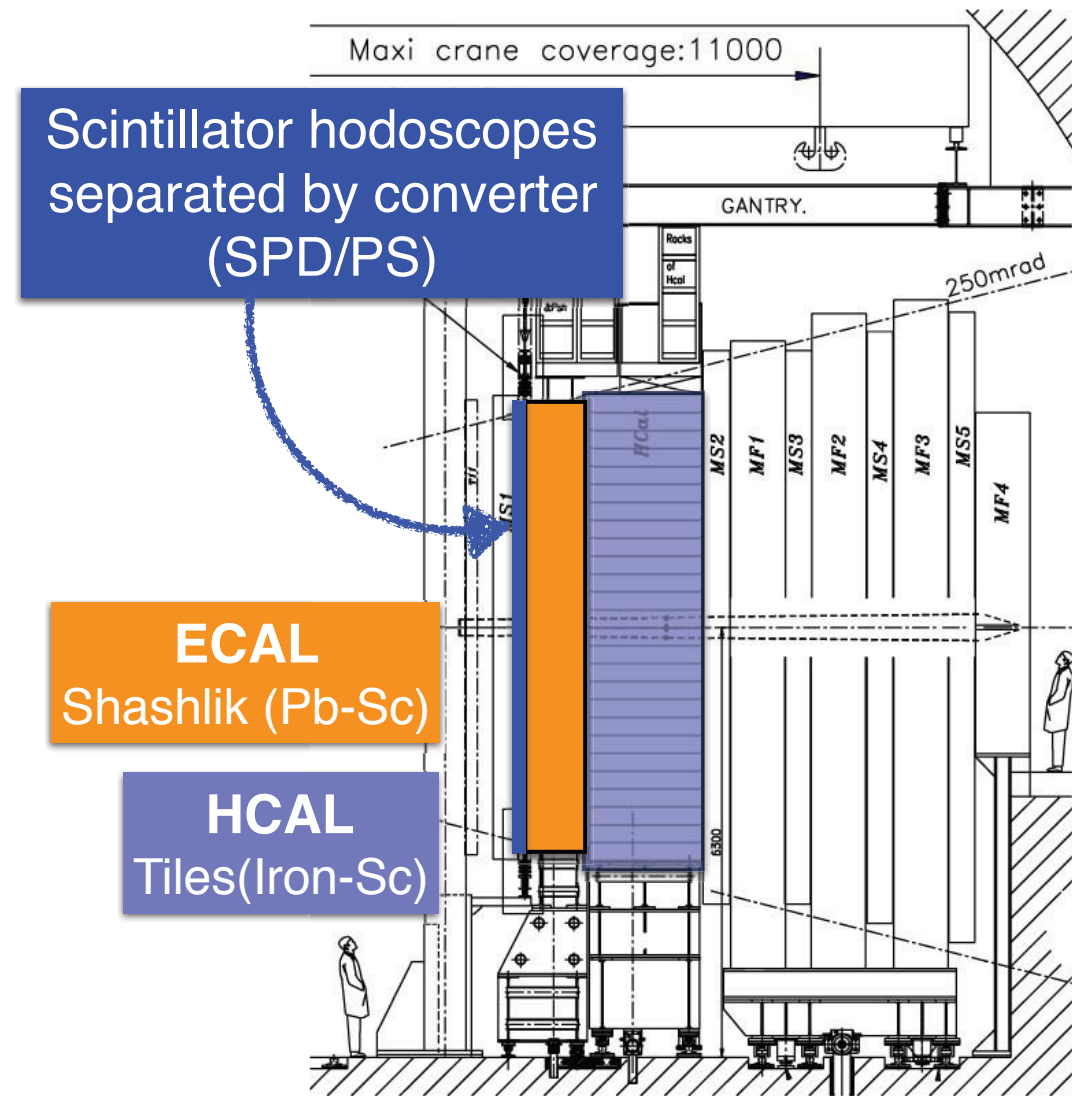
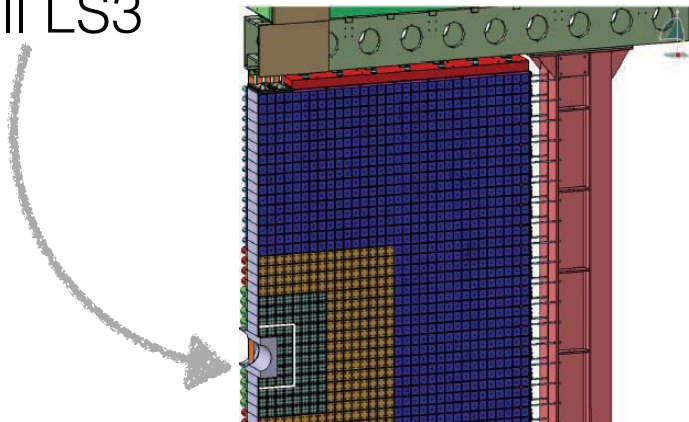

Calorimeters

- New design of FE electronics - must compensate for gain reduction of the PMTs by factor 5 (to avoid faster ageing due to higher Lumi)
- SPD/PS will be removed, as their main use is in the L0 trigger (only small effect on photon id)
- Modules will survive first period of upgrade operation. For the ECAL innermost cells replacement not needed till LS3

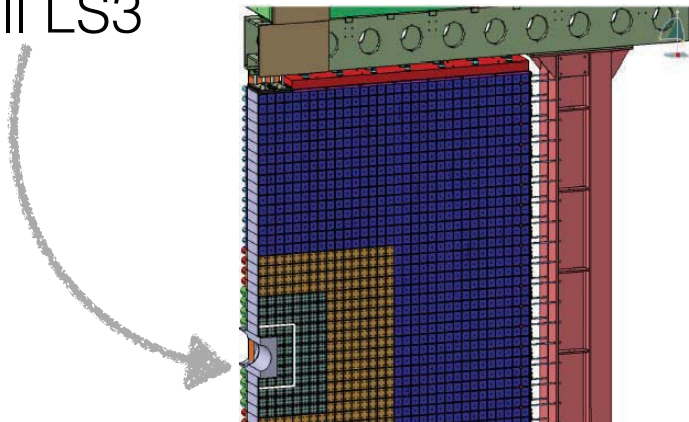

ECAL
Shashlik (Pb-Sc)

HCAL
Tiles (Iron-Sc)

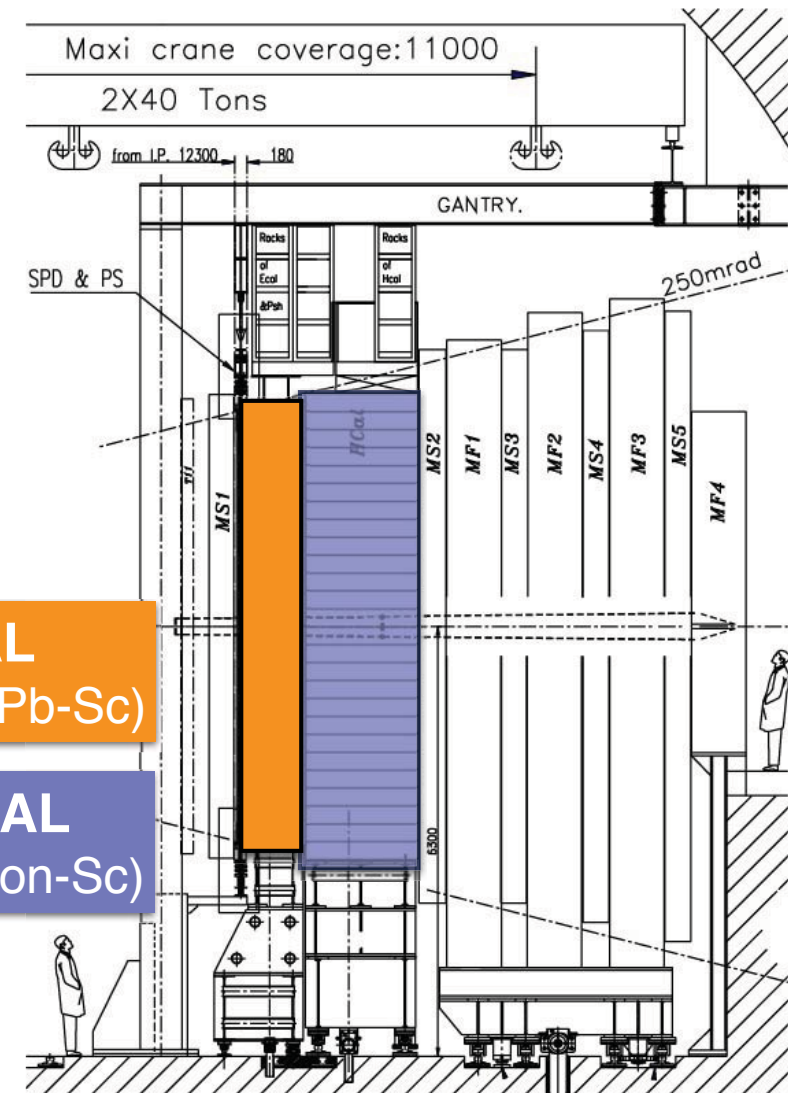

Muon system

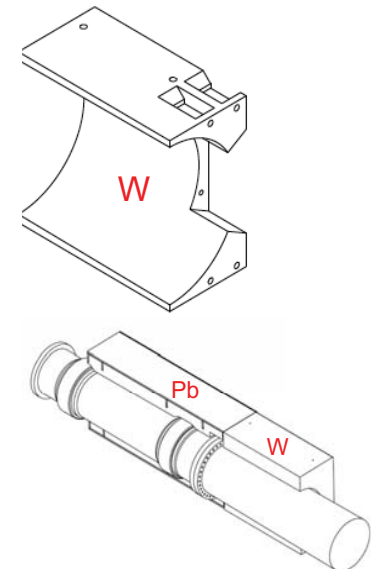
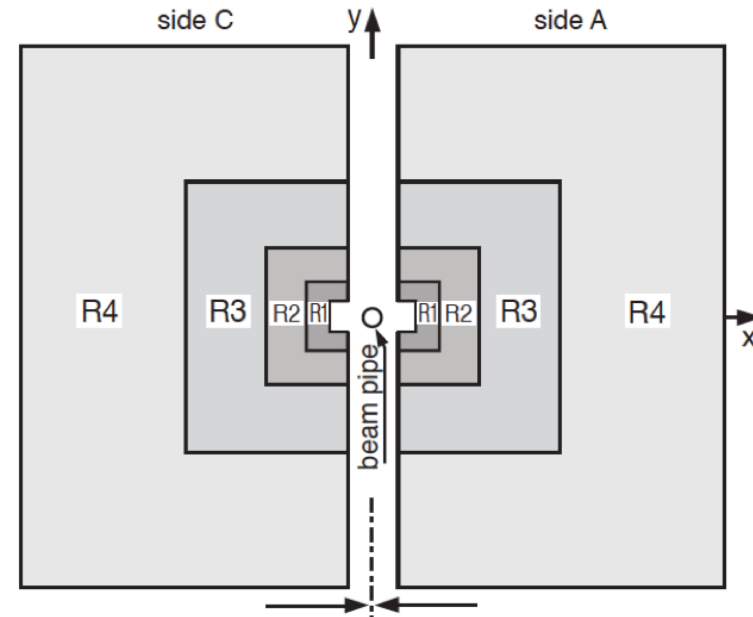
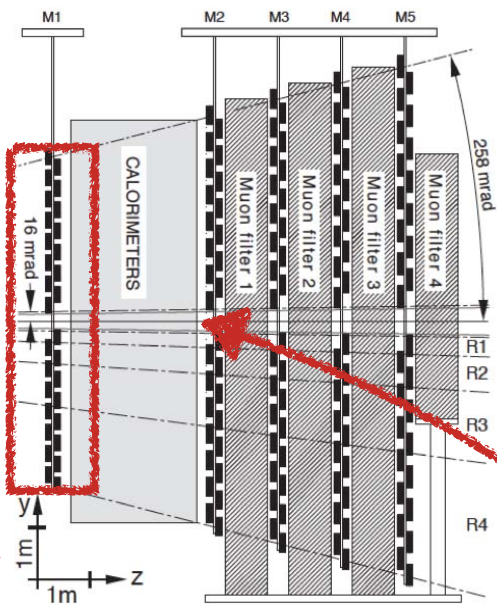

- M1 will be removed: currently used by L0, huge hit occupancy at upgrade luminosity
- New off-detector electronics compliant with 40 MHz readout
- Extra shielding (Pb+W) will be installed around the beam pipe in front of M2 to reduce rate in R1 region by ~60%
- Ageing is a concern after LS3, especially in innermost region of M2 → Ongoing R&D programme
- Optimisation of muon-id algorithms

Muon ID performance

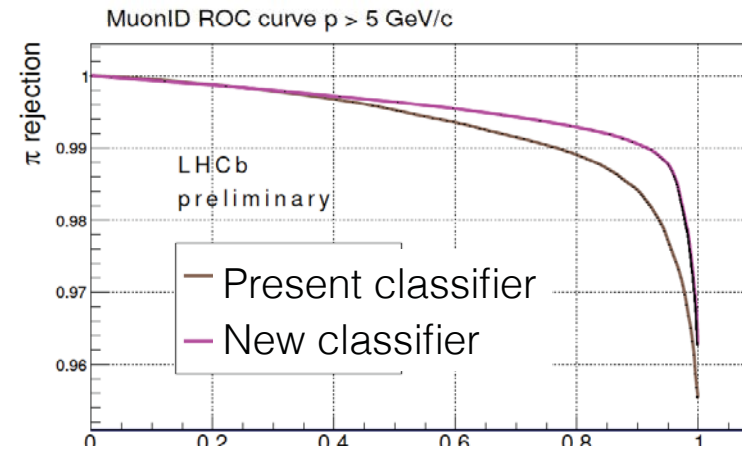
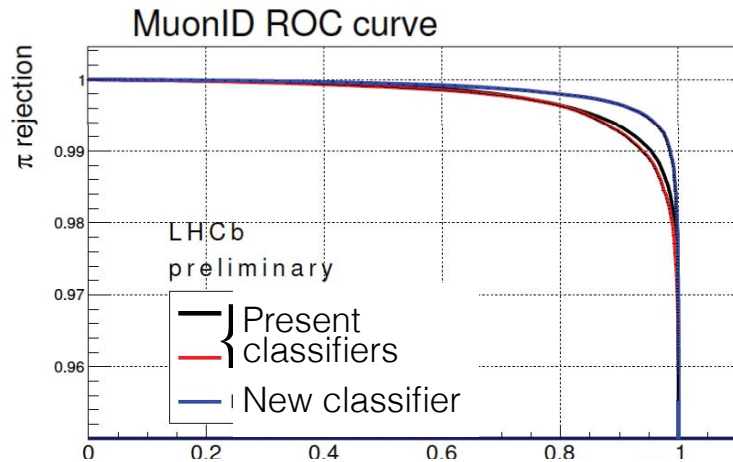
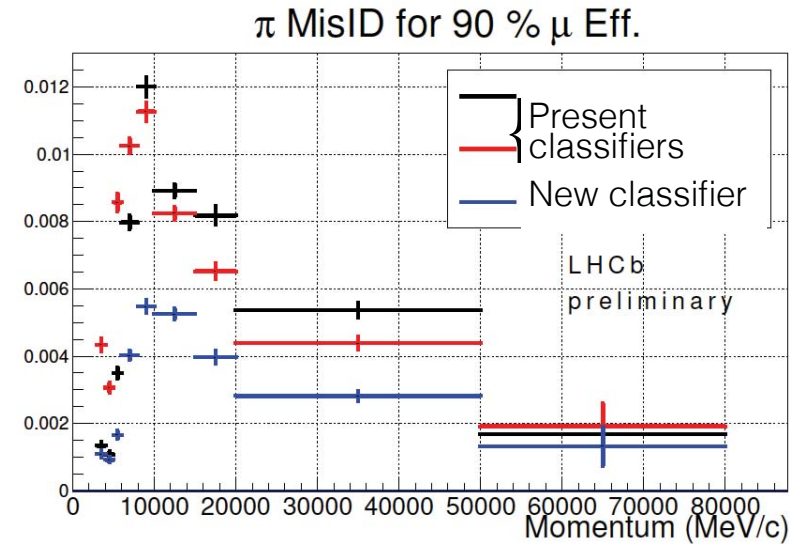
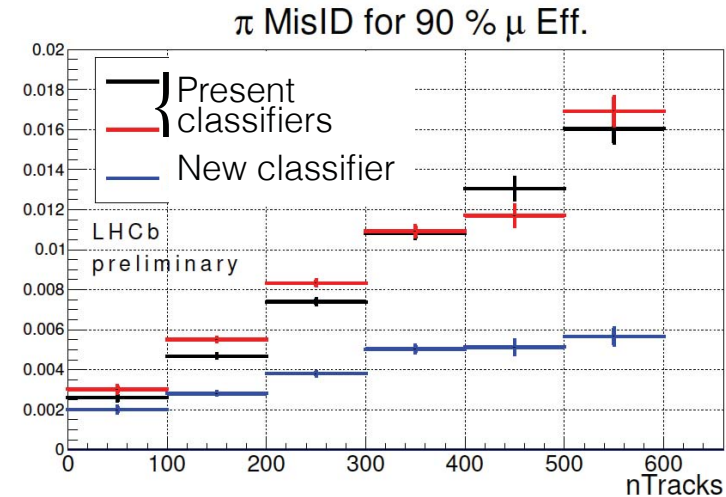

- Work on algorithms ongoing and very significant improvement already achieved
- Stability as a function of track multiplicity is important

Upgrade DAQ

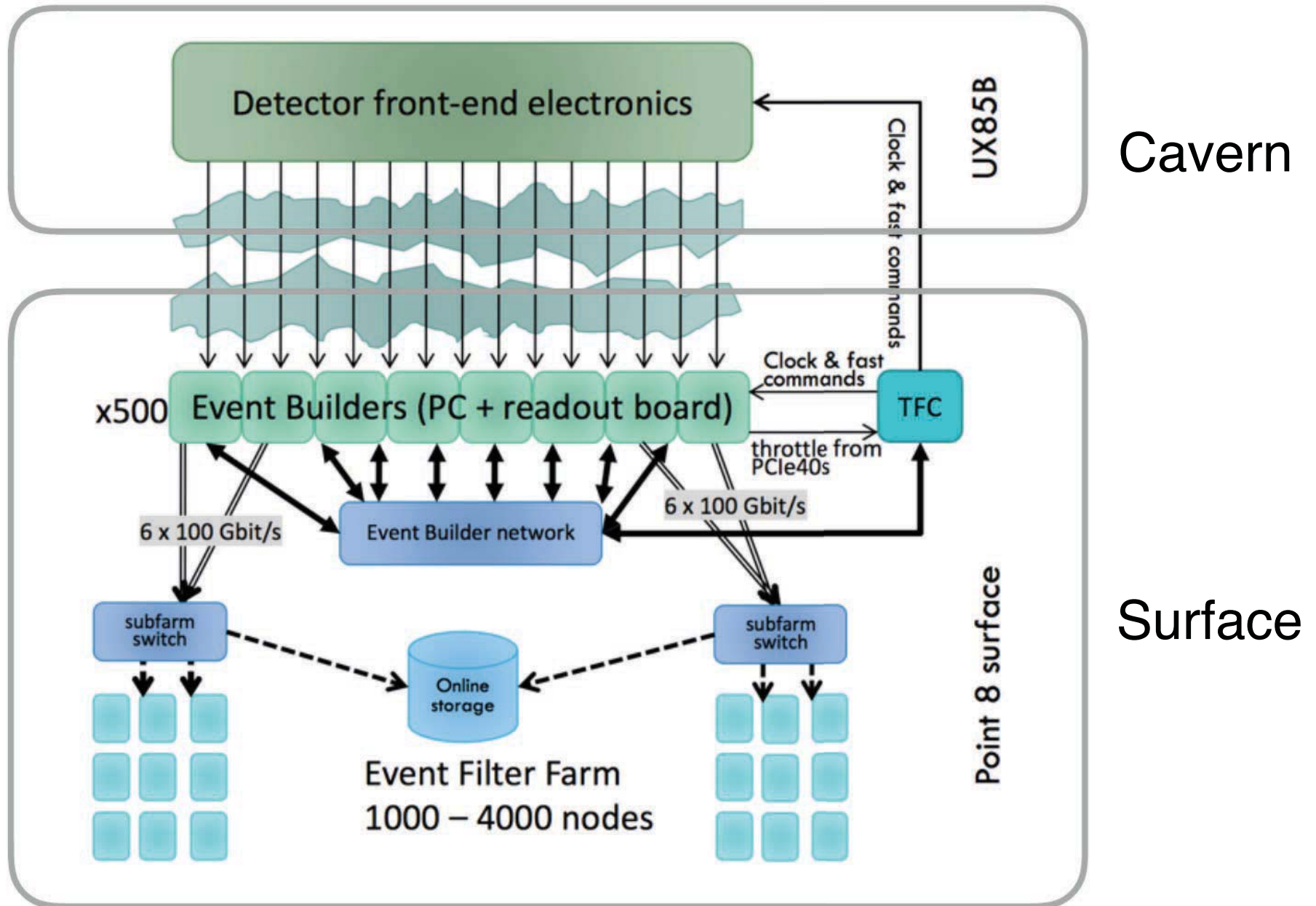

LHCb upgrade - status

- Construction project on schedule, but tight
- Prototypes exist for most major elements
 - Engineering Design/ Production Readiness Reviews being conducted
- In some case production well underway
- Major industrial orders placed

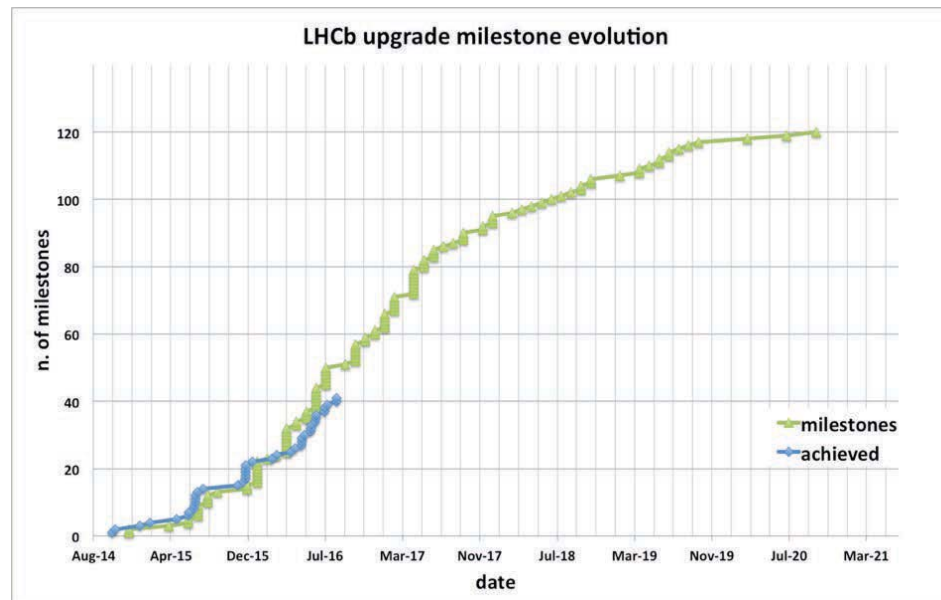

The future after the future

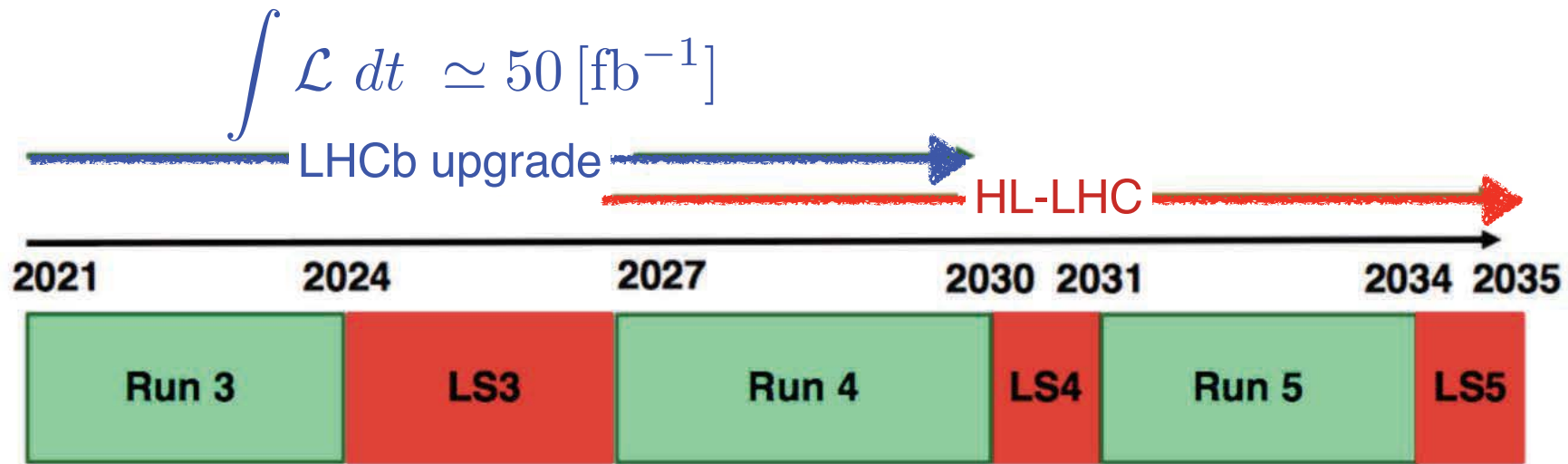

- While working for the upgrade, discussion started on what to do during the very long shutdown for HL-LHC (LS3) planned for 2024
- Several ideas on the table to consolidate and enhance LHCb with new capabilities that will bring extended physics opportunities in Run 4
- Lay the foundations for a phase-2 Upgrade to be installed during LS4 with a target Lumi of $\sim 2 \times 10^{34} \text{ cm}^{-2} \text{ s}^{-1}$ (x10 wrt phase-1 upgrade) integrating 300 fb^{-1} . With pileup of ~ 50 , adding timing information will be key.

LS3: Consolidation & modest enhancements

- **Financial and personnel resources limited**
- Improving the muon shielding by replacing HCAL with iron
- Building new, high-rate, muon chambers for busy regions
- Replacing central region of RICH1 photodetector plane with new high granularity SiPMs
- Replacing inner SciFi modules with SciFi/ silicon
- Adding side chambers in magnet
- TORCH for fast-timing and PID purposes
- Replacing some of ECAL with high performant technology

The future after the future

	LHC Run	Period of data taking	Maximum \mathcal{L} [$\text{cm}^{-2}\text{s}^{-1}$]	Cumulative $\int \mathcal{L} dt$ [fb^{-1}]
Current detector	1 & 2	2010–2012, 2015–2018	4×10^{32}	8
Phase-I Upgrade	3 & 4	2021–2023, 2026–2029	2×10^{33}	50
Phase-II Upgrade	5 \rightarrow	2031–2033, 2035 \rightarrow	2×10^{34}	300

$$\int \mathcal{L} dt \simeq 50 [\text{fb}^{-1}]$$

- Strong arguments to continue flavour physics after Run 3**
Many measurements of suppressed decays of heavy-flavoured hadrons, which are interesting to probe New Physics effects, will still be statistically limited after the LHCb phase-1 upgrade
- Lay the foundations for a phase-2 Upgrade to be installed during LS4 with a target Lumi of $\sim 2 \times 10^{34} \text{ cm}^{-2} \text{ s}^{-1}$ (x10 wrt phase-1 upgrade) integrating 300 fb^{-1}



CERN/LHCC 2017-003

LHCb EoI

08 February 2017

LHCb EoI UPGRADE II



Opportunities in flavour physics,
and beyond, in the HL-LHC era

Expression of Interest

The SM as an emerging iceberg



What is there under the water?

Exciting New Physics in the multiTev region?



Exciting New Physics
in the multiTev region?



... or SM up to
 $E \gg \text{TeV}$

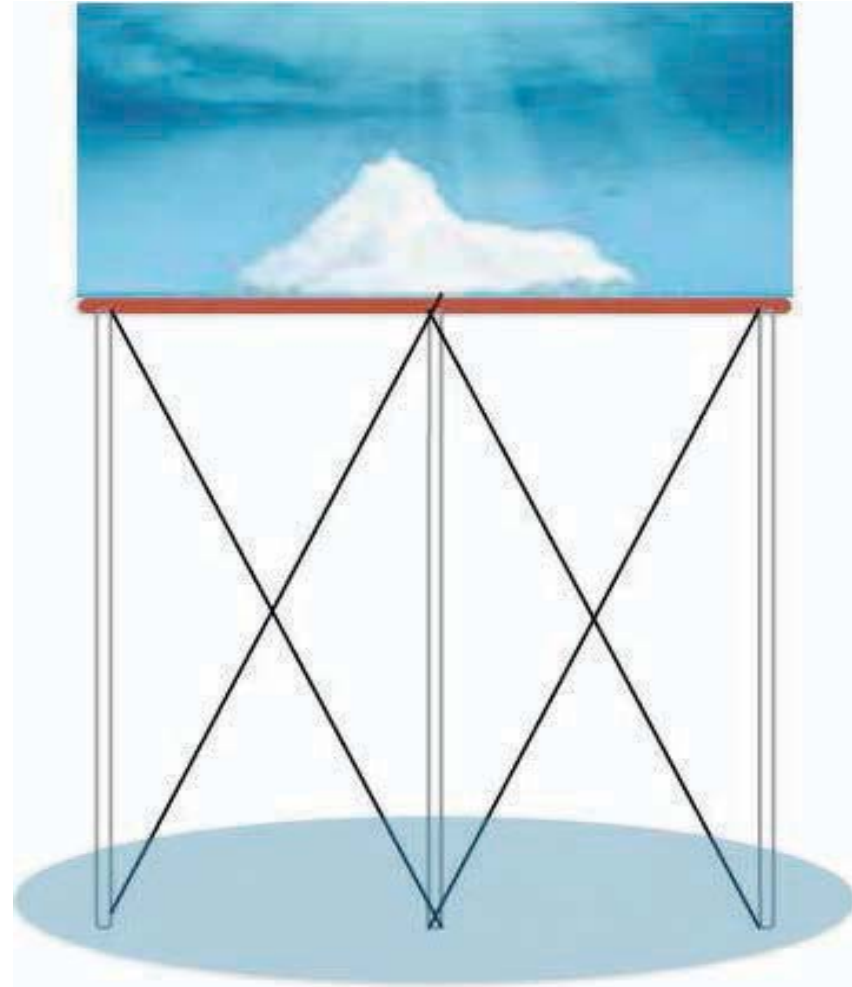

In the current uncertain situation of particle physics it is useful/necessary to have a diversified programme in which flavour plays an important role

Conclusions

- Wealth of LHCb results at “CERN’s flavour factory”
- Everything worked beautifully : detector, trigger, data analysis...
- We have shown to be ready for Run 2 and implemented many clever and innovative ideas relevant for the upgrade, e.g. the detector calibration and alignment in real time
- We are working hard to build the upgraded detector and the construction is well on track
- This does not stop us from bringing forward new ideas: the upgrade of the upgrade or LHCb@HL