



Search for High Mass SM Higgs at the Tevatron

Les Rencontres de Physique
de la Vallée D'Aoste
Mar. 6, 2009

Herbert Greenlee
Fermilab
for the CDF and D0 Collaborations

SM Higgs Boson

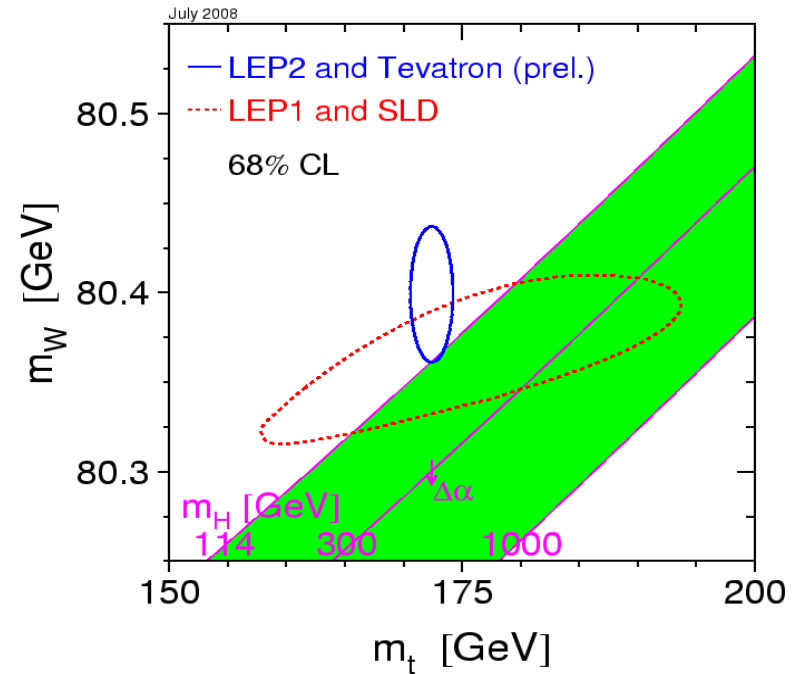
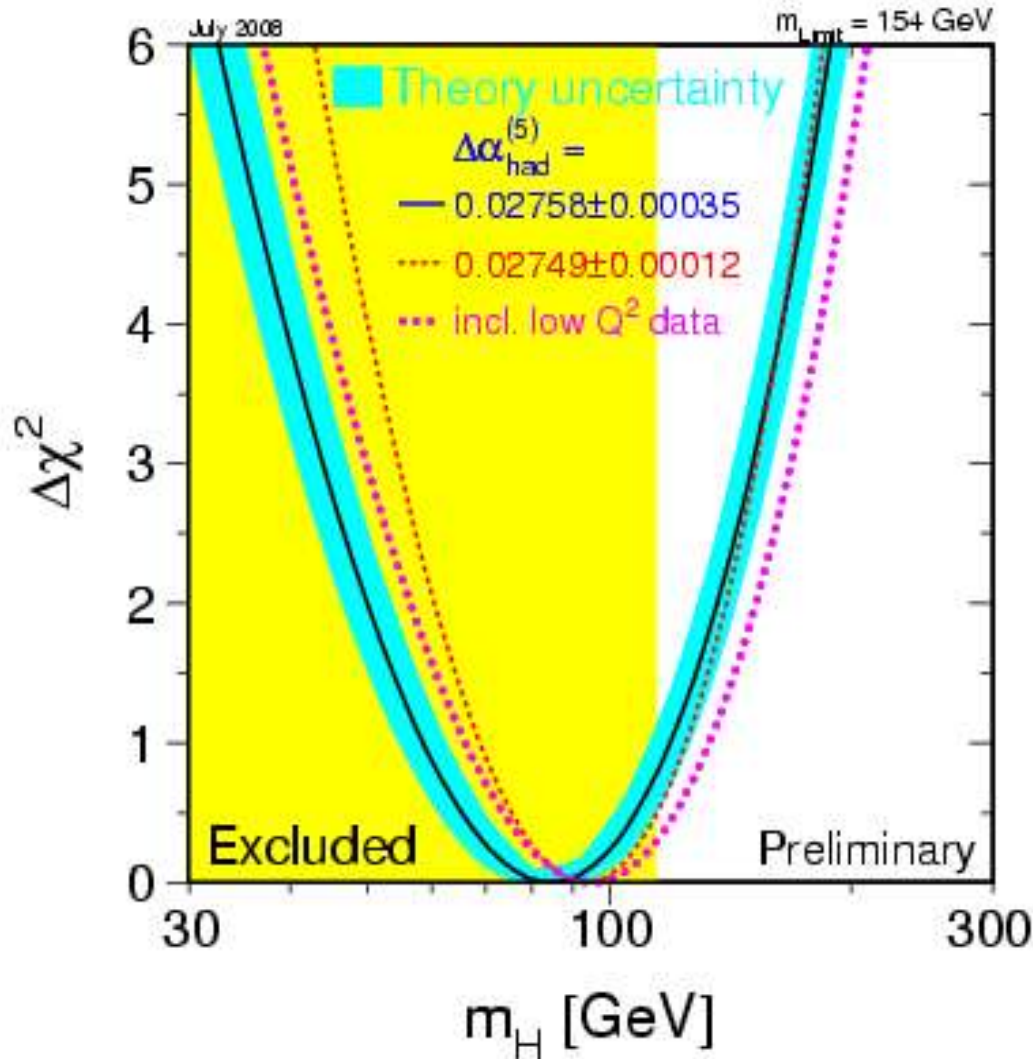

- Direct Limit (LEP)

$$M_{\text{H}} > 114 \text{ GeV}$$

- Indirect Limit

$$M_{\text{H}} = 84^{+34}_{-26} \text{ GeV}$$

$$M_{\text{H}} < 154 \text{ GeV @ 95\% CL}$$

Fermilab Tevatron

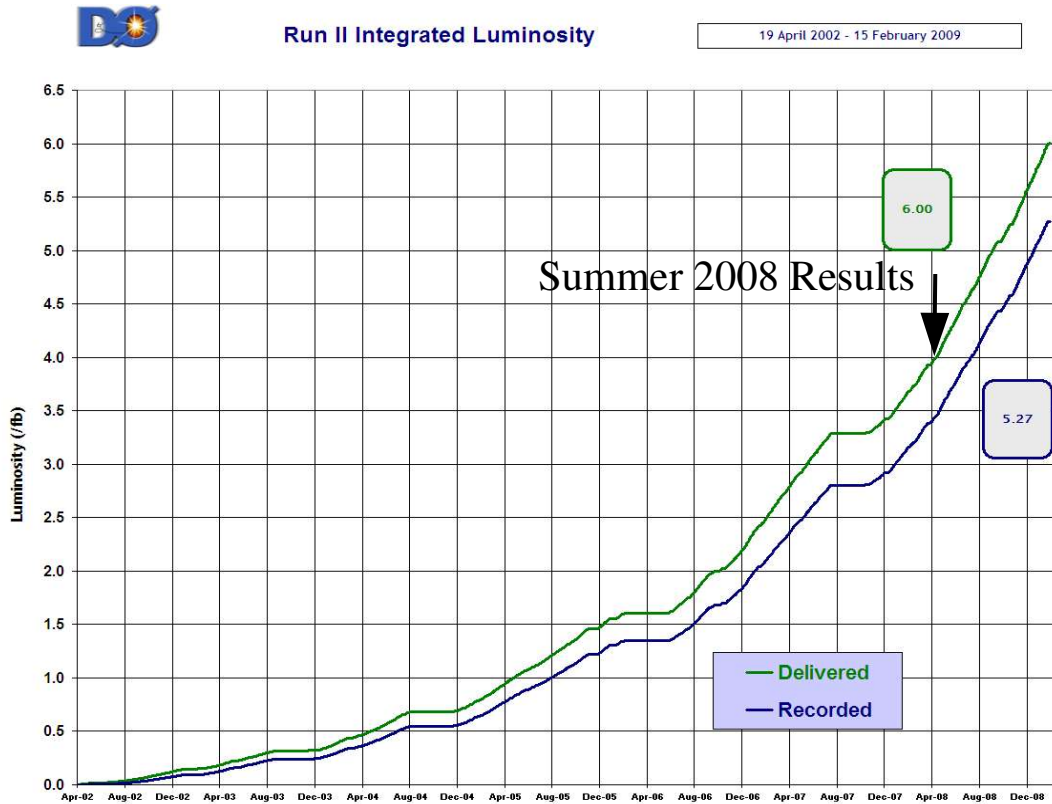

- $\bar{p}p$ collisions @ $\sqrt{s}=1.96$ TeV.
- CDF and D0 general purpose experiments.

Higgs Production and Decay at the Tevatron

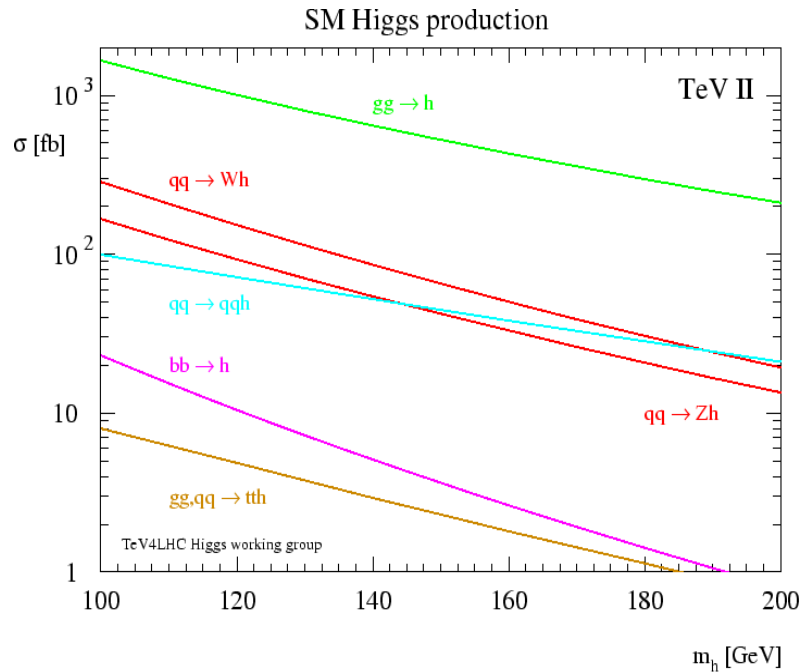

- Gluon Fusion

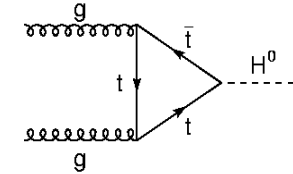

- Associated Production

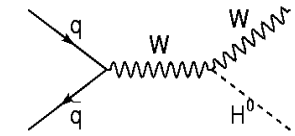

- Vector Boson Fusion

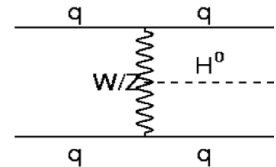

- $H \rightarrow WW$ dominant decay for $m_H > 135$ GeV (“high mass”).
- $H \rightarrow b\bar{b}$ dominant decay for $m_H < 135$ GeV (“low mass”).

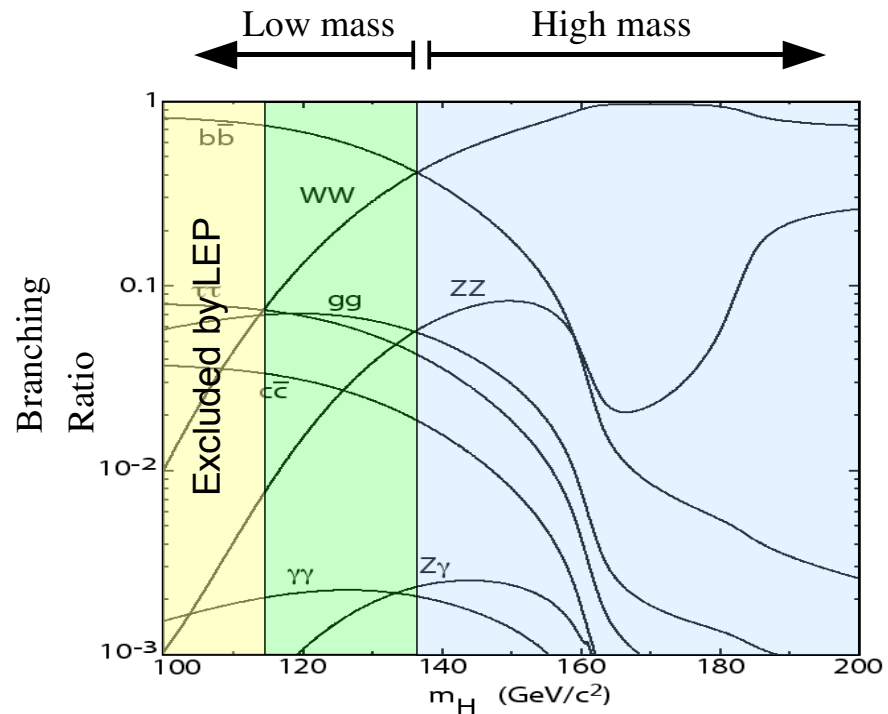

Experimental Higgs Search Channels

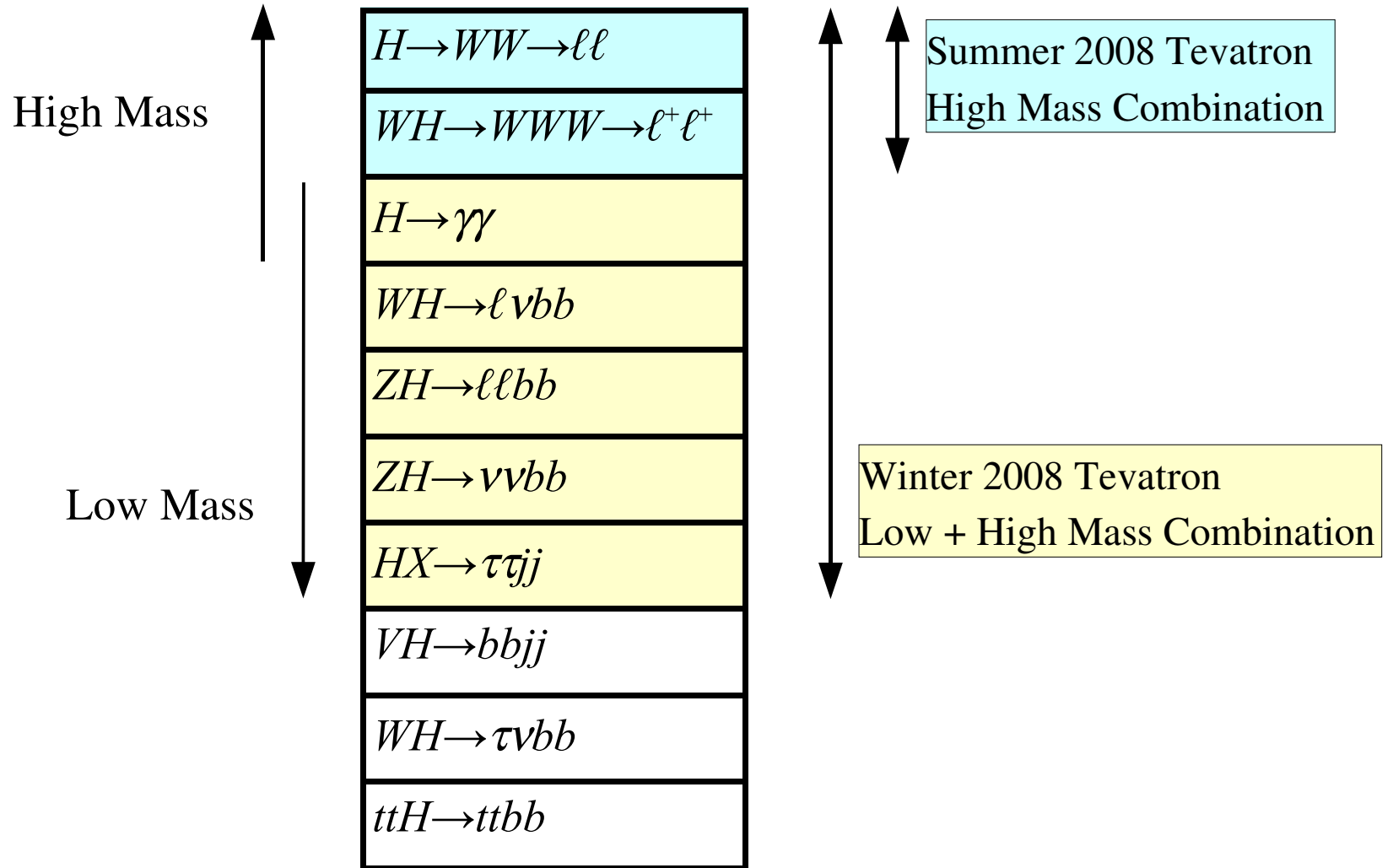

Tevatron High Mass Channels

| Channel | Integrated Luminosity (fb ⁻¹) | | | |
|--|---|-----|-------------|-----|
| | Summer 2008 | | Winter 2009 | |
| | CDF | D0 | CDF | D0 |
| $H \rightarrow WW \rightarrow \ell\ell$ | 3.0 | 3.0 | 3.6 | 3.0 |
| $WH \rightarrow WWW \rightarrow \ell^+ \ell^+$ | 1.9 | 1.1 | 3.6 | 1.1 |

- Additional results and new Tevatron combination expected soon.

$H \rightarrow WW$

- Most sensitive Higgs channel at the Tevatron.
 - Highest sensitivity around $M_H = 160$ GeV.
- Signature two high p_T leptons ($\ell = e$ or μ) and missing E_T .
- Backgrounds: WW , WZ , ZZ , tt , $W + \gamma/\text{jets}$, $Z \rightarrow \ell\ell$, $Z \rightarrow \tau\tau$, QCD.
- Strategies.
 - Good lepton id and missing E_T resolution.
 - WW is a fundamental physics background, and one of the largest backgrounds. Spin correlation ($\Delta\phi_{\ell\ell}$) is the best single variable for discriminating H and WW .
 - All subchannels and both experiments make use of advanced multivariate techniques to get best possible signal / background discrimination.

$H \rightarrow WW$ Systematic Errors

- Theoretical.
 - Total cross sections (H , WW , W +jets).
 - Differential cross sections ($p_T(Z)$, $p_T(W)$).
 - PDFs.
- Simulation.
 - Lepton / jet / missing E_T energy scale & resolution.
 - Lepton id efficiencies.
- Fake backgrounds / fake rates.
- Luminosity.

Spin Correlation in $H \rightarrow WW$

- Leptons from $H \rightarrow WW \rightarrow \ell\ell$ tend to be emitted in the same direction (i.e. small $\Delta\phi(\ell, \ell)$).

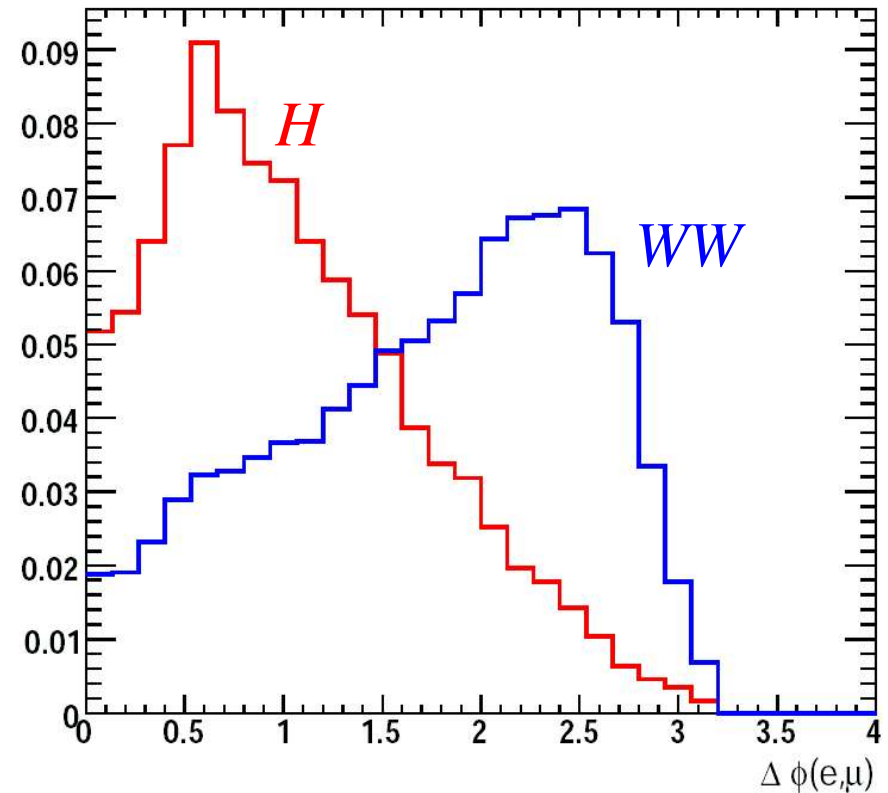
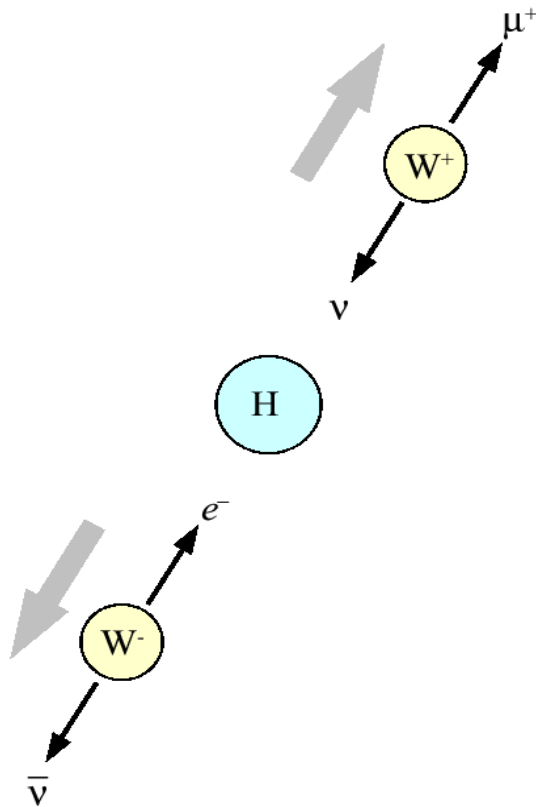

Multivariate Analysis Techniques

- **Neural Networks (NN).**
 - Works well. Time-tested – have been used successfully for many years.
- **Boosted Decision Trees (BDT).**
 - Relatively recent. Popularity has grown enormously recently.
- **Matrix Element (ME).**
 - Highly efficient for specific signals / backgrounds.
 - Computationally costly.
 - Can be used as input to other techniques.

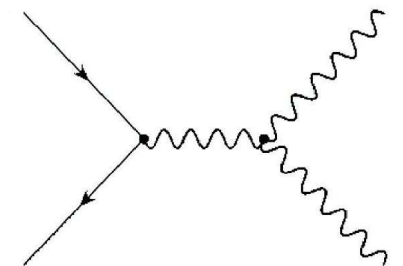
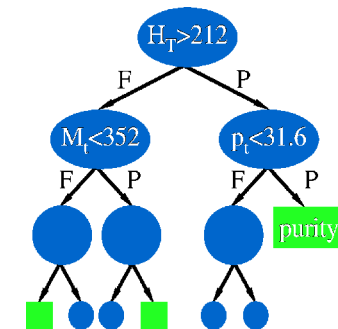
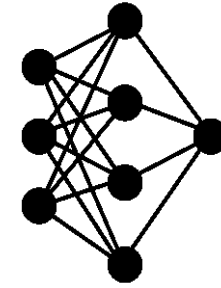



$H \rightarrow WW$ Event Selection

| | ee | $e\mu$ | $\mu\mu$ |
|-------------------------------------|---|--------|----------|
| Leptons (preselection) | $p_T(\mu) > 10 \text{ GeV}, p_T(e) > 15 \text{ GeV}, M_{\ell\ell} > 15 \text{ GeV}$ | | |
| \cancel{E}_T (GeV) | >20 | >20 | >20 |
| $\cancel{E}_T^{\text{Scaled}}$ | >7 | >6 | >5 |
| $M_T^{\text{min}}(\ell, E_T)$ (GeV) | >20 | >30 | >20 |
| $\Delta\phi(\ell, \ell)$ | <2.0 | <2.0 | <2.5 |

| | $e\mu$ pre-selection | $e\mu$ final | ee pre-selection | ee final | $\mu\mu$ pre-selection | $\mu\mu$ final |
|------------------------------------|----------------------|-----------------|--------------------|-----------------|------------------------|-----------------|
| $Z \rightarrow ee$ | 209.0 ± 3.0 | 0.72 ± 0.16 | 160463 ± 264 | 73.6 ± 5.1 | – | – |
| $Z \rightarrow \mu\mu$ | 151.1 ± 0.6 | 2.14 ± 0.06 | – | – | 256432 ± 230 | 957 ± 14 |
| $Z \rightarrow \tau\tau$ | 2312 ± 2 | 2.45 ± 0.05 | 835 ± 8 | 1.0 ± 0.3 | 1968 ± 11 | 5.5 ± 0.5 |
| $t\bar{t}$ | 187.5 ± 0.2 | 54.2 ± 0.1 | 96.9 ± 0.2 | 28.5 ± 0.1 | 19.4 ± 0.1 | 10.1 ± 0.1 |
| $W + jets$ | 163.4 ± 5.3 | 60.1 ± 3.2 | 174 ± 7 | 72.0 ± 4.3 | 149 ± 3 | 85.8 ± 2.1 |
| WW | 285.6 ± 0.1 | 108.0 ± 0.1 | 127.5 ± 0.4 | 45.7 ± 0.2 | 162.9 ± 0.5 | 91.3 ± 0.3 |
| WZ | 14.8 ± 0.1 | 4.9 ± 0.1 | 89.6 ± 0.8 | 7.6 ± 0.2 | 51.6 ± 0.5 | 16.2 ± 0.3 |
| ZZ | 3.47 ± 0.01 | 0.49 ± 0.01 | 73.5 ± 0.3 | 5.4 ± 0.1 | 43.0 ± 0.2 | 13.5 ± 0.1 |
| Multi-jet | 190 ± 168 | 1 ± 8 | 2322 ± 193 | 4.3 ± 8.3 | 945 ± 31 | 63.6 ± 8.0 |
| Signal ($m_H = 160 \text{ GeV}$) | 9.0 ± 0.1 | 6.9 ± 0.1 | 4.40 ± 0.01 | 3.49 ± 0.01 | 4.7 ± 0.1 | 4.09 ± 0.06 |
| Total Background | 3516 ± 168 | 234 ± 9 | 164181 ± 327 | 238 ± 11 | 259770 ± 232 | 1242 ± 16 |
| Data | 3706 | 234 | 164290 | 236 | 263743 | 1147 |



$H \rightarrow WW$ NN Analysis

- Neural network analysis makes use of 14 input variables.

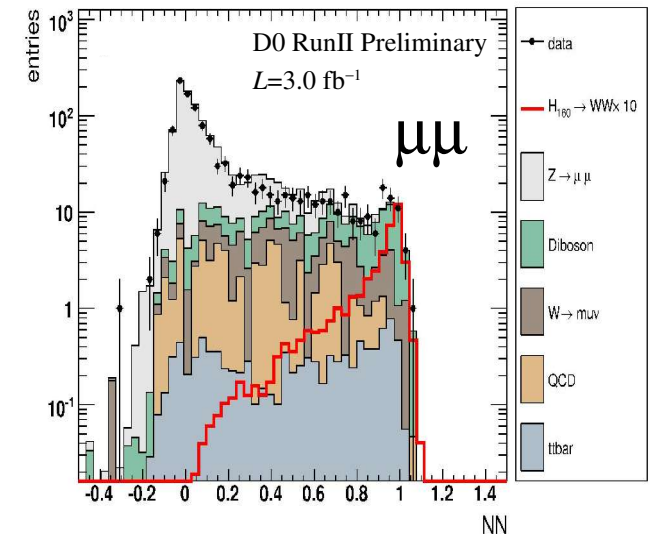
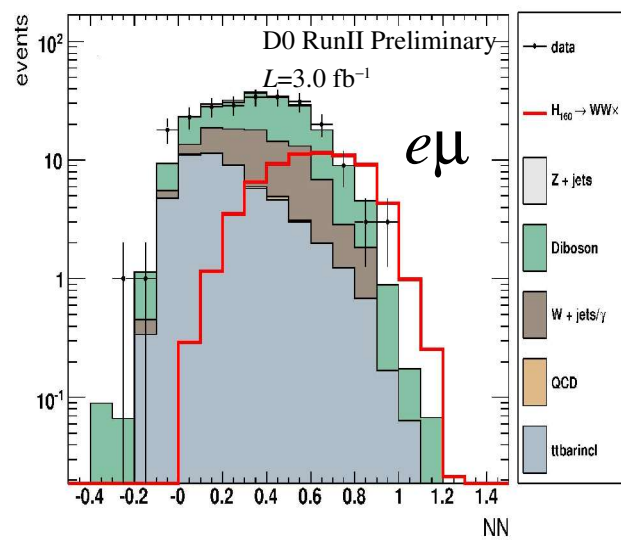
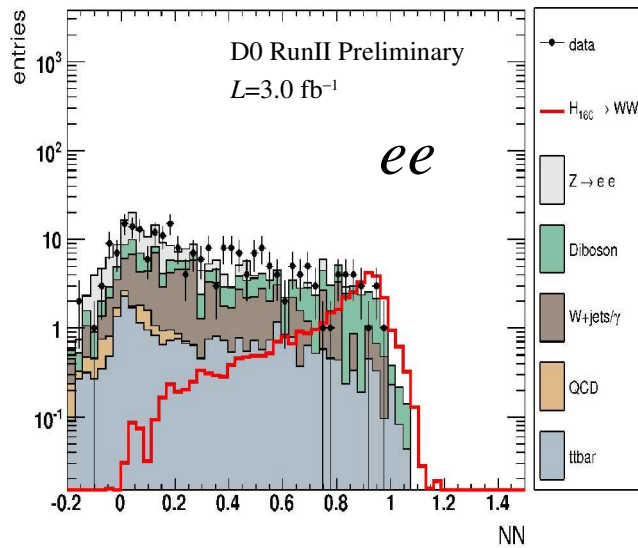



$H \rightarrow WW$ Result

- Upper limit on $\sigma \times \text{BR}$ set using entire NN output distribution for all channels using modified frequentist method (CLs method).

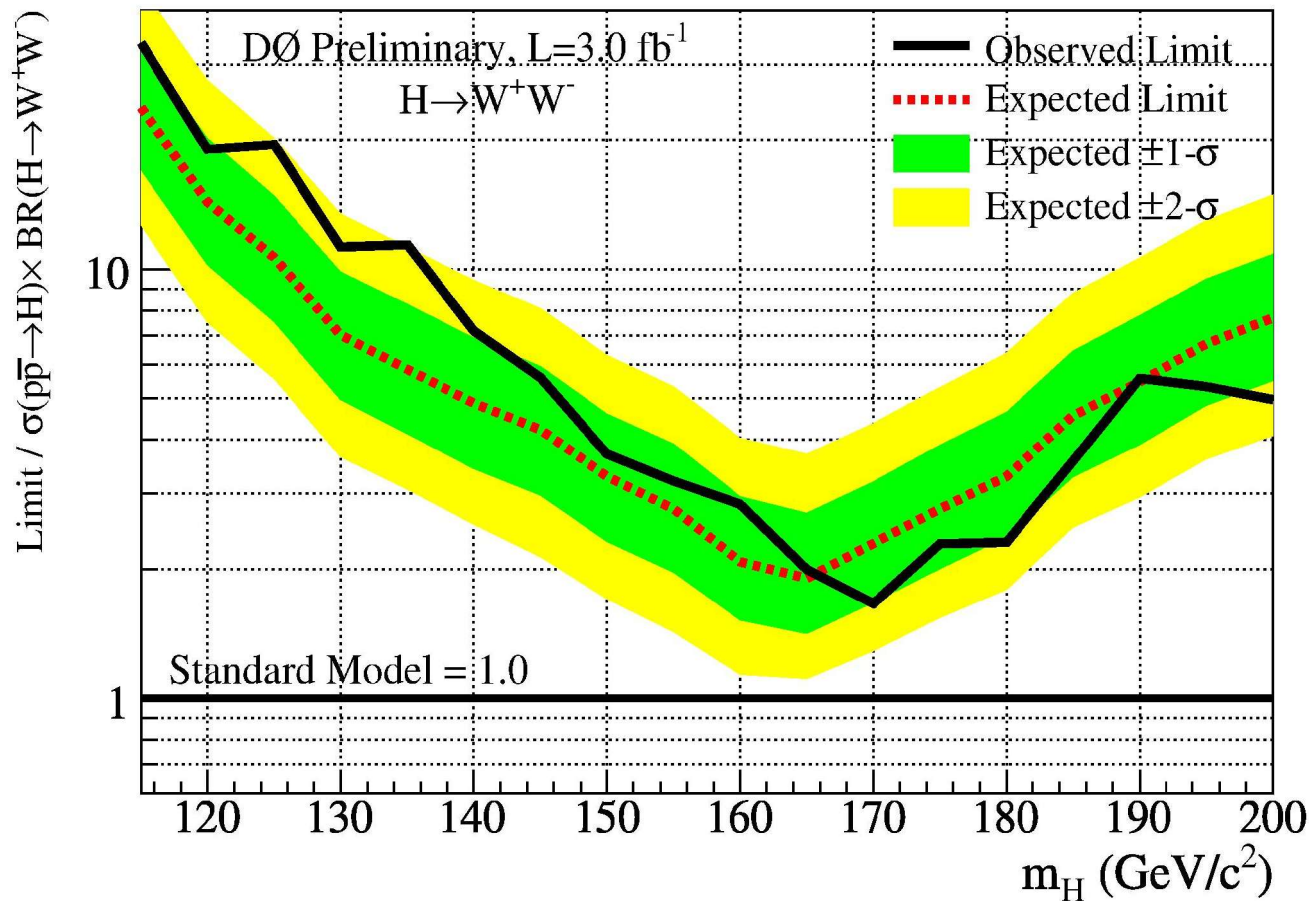

Expected limit is
2.1 times SM at
 $M_H = 160 \text{ GeV}$



$H \rightarrow WW$ Event Selection

| | ee | $e\mu$ | $\mu\mu$ |
|---|---|--------|----------|
| Leptons | $p_{T1} > 20 \text{ GeV}, p_{T2} > 10 \text{ GeV}, M_{\ell\ell} > 16 \text{ GeV}$ | | |
| $\cancel{E}_{T\text{spec}} \text{ (GeV)}$ | >25 | >15 | >25 |
| $\cancel{E}_{T\text{spec}} = \cancel{E}_T \sin\{\min[\pi/2, \Delta\phi(E_T, \ell j)]\}$ | | | |

- Separate NN analysis for 0, 1, and ≥ 2 jets.
- 1 and 2 jets includes VBF and VH contributions to signal.
- Also separate NN analysis for high and low S/B events based on lepton quality for 0 and 1 jets.

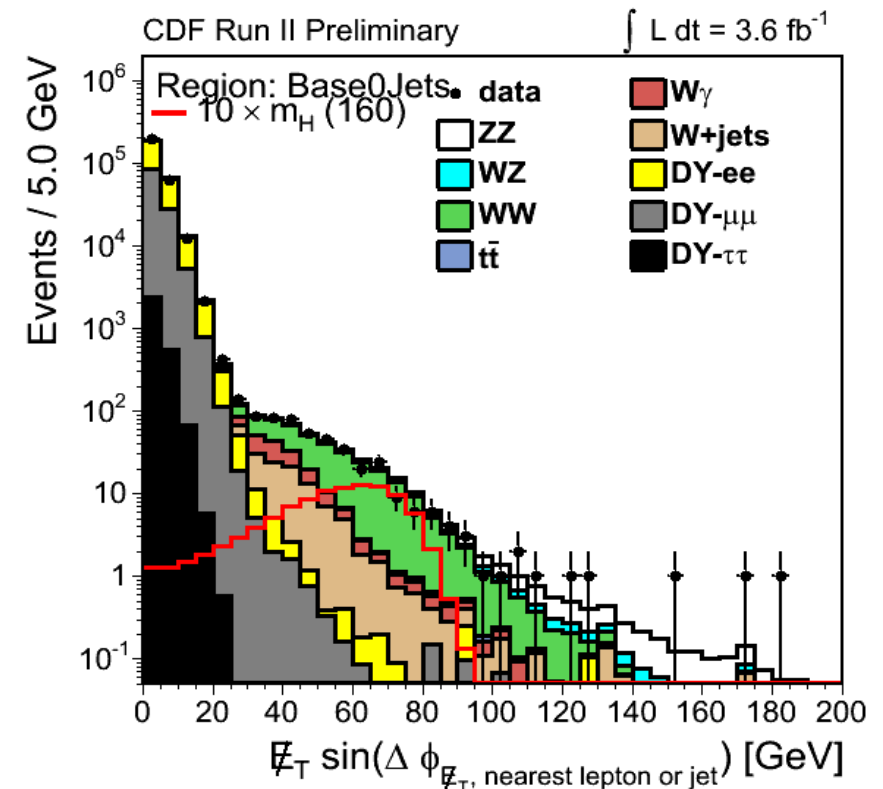



$H \rightarrow WW$ 0 jets NN Analysis

- Neural network analysis makes use of 5 input variables, including $\Delta\phi_{\ell\ell}$ and H vs. WW matrix element likelihood ratio (LRHWW).
- Separate NN for high and low S/B lepton id.

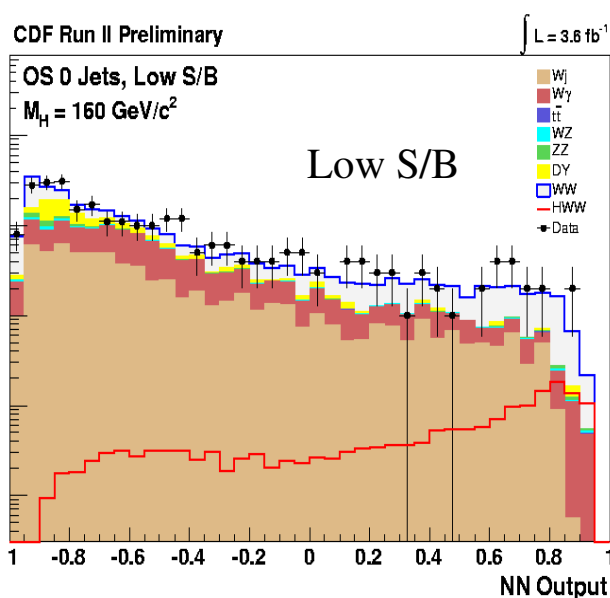
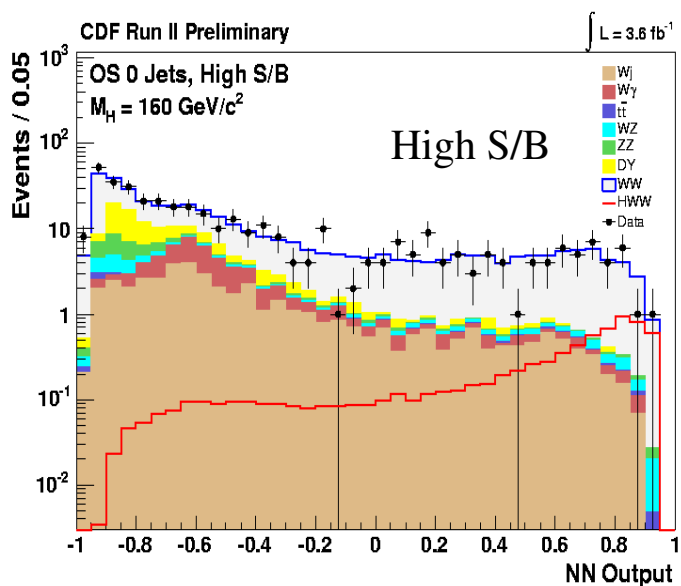

CDF Run II Preliminary $\int \mathcal{L} = 3.6 \text{ fb}^{-1}$
 $M_H = 160 \text{ GeV}/c^2$

| | |
|-------------------------|---------------------------------|
| $t\bar{t}$ | 1.35 ± 0.21 |
| DY | 80 ± 18 |
| WW | 318 ± 35 |
| WZ | 13.8 ± 1.9 |
| ZZ | 20.7 ± 2.8 |
| $W+\text{jets}$ | 113 ± 27 |
| $W\gamma$ | 92 ± 25 |
| Total Background | 637 ± 67 |
| Total Signal | 9.5 ± 1.4 |
| Data | 651 |

OS 0 Jets



$H \rightarrow WW$ 1 jets NN Analysis

- Neural network analysis makes use of 8 input variables (LRHWW not included for >0 jets).
- Separate NN for high and low S/B lepton id.

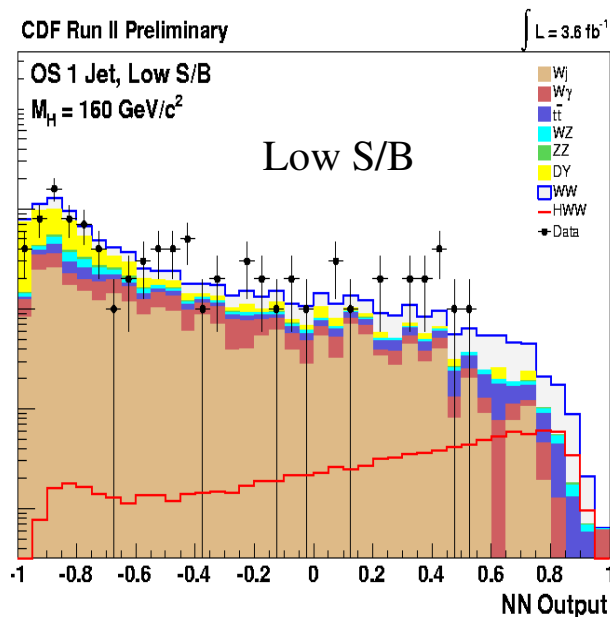
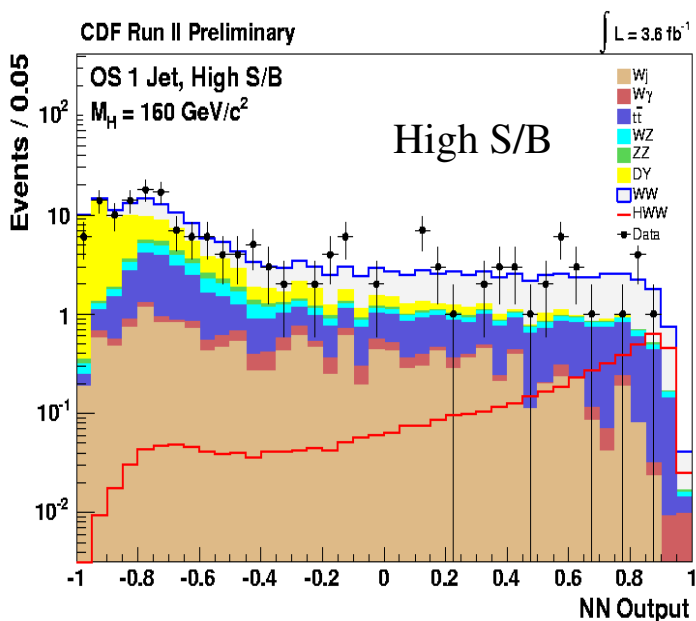

CDF Run II Preliminary $\int L = 3.6 \text{ fb}^{-1}$
 $M_H = 160 \text{ GeV}/c^2$

| | |
|-------------------------|-----------------------------------|
| $t\bar{t}$ | 34.9 ± 5.5 |
| DY | 85 ± 27 |
| WW | 85.3 ± 9.1 |
| WZ | 14.5 ± 2.0 |
| ZZ | 5.48 ± 0.75 |
| W+jets | 40 ± 10 |
| W γ | 13.2 ± 4.0 |
| Total Background | 278 ± 35 |
| Total Signal | 5.98 ± 0.78 |
| Data | 262 |

OS 1 Jet



$H \rightarrow WW$ 2+ jets NN Analysis

- Neural network analysis makes use of 8 input variables.
- High and low S/B lepton id not used for ≥ 2 jets.

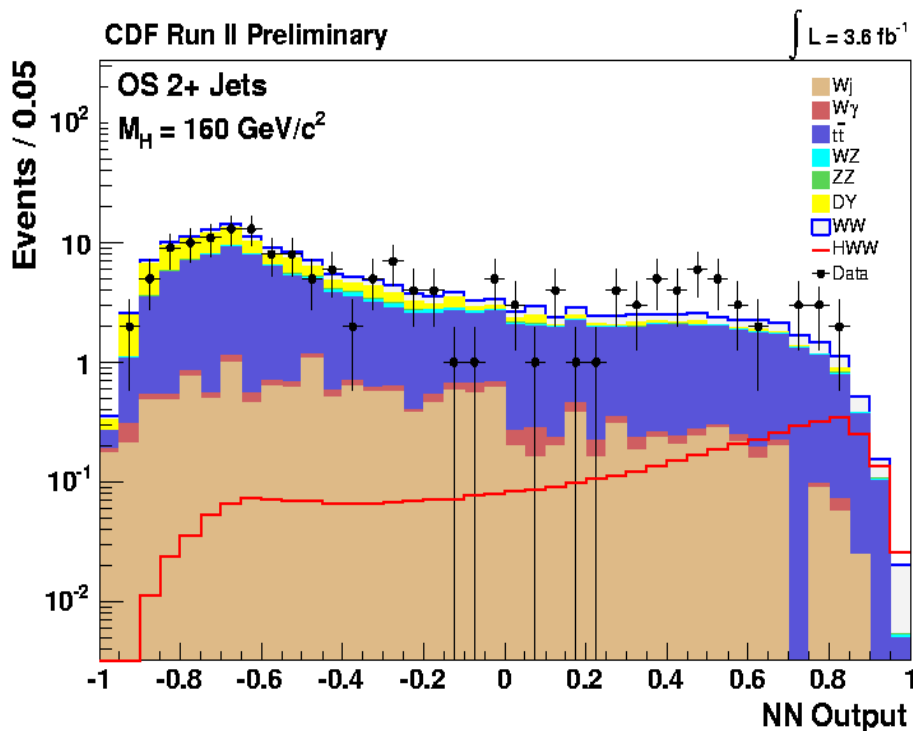

CDF Run II Preliminary $\int \mathcal{L} = 3.6 \text{ fb}^{-1}$
 $M_H = 160 \text{ GeV}/c^2$

| | |
|-------------------------|-----------------------------------|
| $t\bar{t}$ | 100 \pm 17 |
| DY | 33 \pm 11 |
| WW | 17.6 \pm 4.0 |
| WZ | 3.76 \pm 0.52 |
| ZZ | 1.62 \pm 0.22 |
| W+jets | 14.7 \pm 4.0 |
| W γ | 2.12 \pm 0.70 |
| Total Background | 173 \pm 23 |
| $gg \rightarrow H$ | 1.75 \pm 0.30 |
| WH | 1.39 \pm 0.18 |
| ZH | 0.693 \pm 0.090 |
| VBF | 0.70 \pm 0.11 |
| Total Signal | 4.53 \pm 0.52 |
| Data | 169 |

OS 2+ Jets

$H \rightarrow WW$ Result

- Upper limit on $\sigma \times \text{BR}$ obtained likelihood fit of all five NN output distributions.

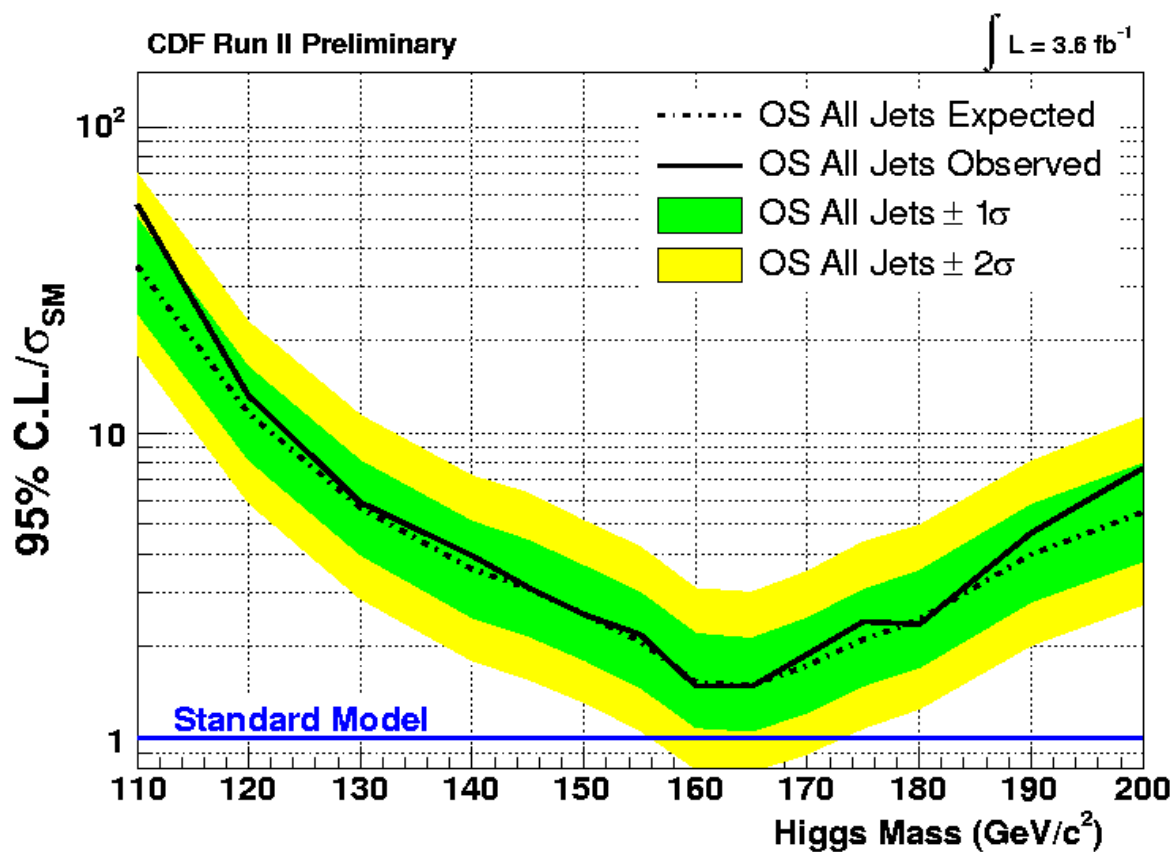

Expected limit is
1.48 times SM at
 $M_H = 160 \text{ GeV}$

$$WH \rightarrow WWW \rightarrow \ell^+ \ell^+$$

- Signature two like-sign high p_T leptons ($\ell=e$ or μ).
- Smaller $\sigma \times \text{BR}$ than $H \rightarrow WW$ but very low SM background.
- Backgrounds: WZ , ZZ , $W+\gamma/\text{jets}$, QCD, charge flips.
 - Instrumental backgrounds (fakes and charge flips) are dominant.



$$WH \rightarrow WWW \rightarrow \ell^+ \ell^+$$

- Event selection: $p_T(e) > 15 \text{ GeV}$, $p_T(\mu) > 15 \text{ GeV}$.
- Upper limit on $\sigma \times \text{BR}$ from 2D multivariate likelihood fit.
 - Expected limit is 17 times SM at $M_H = 160 \text{ GeV}$.

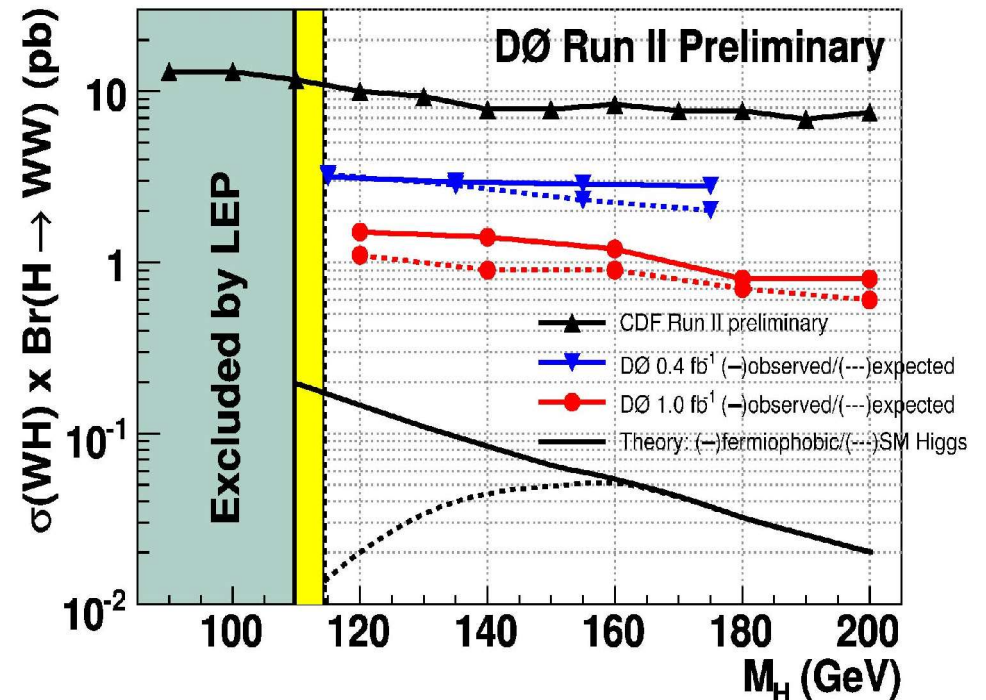
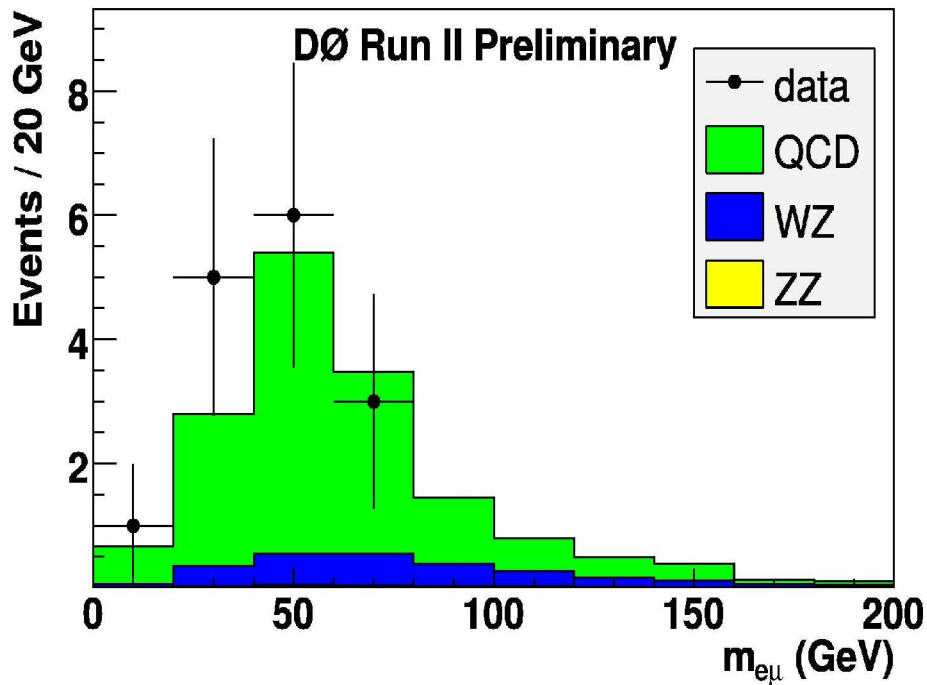



$$WH \rightarrow WWW \rightarrow \ell^+ \ell^+$$

- Event selection: $p_{T1} > 20 \text{ GeV}, p_{T2} > 20 \text{ GeV}.$
- Multivariate analysis using 13-variable NN.
 - Expected limit is 7.2 times SM at $M_H=160 \text{ GeV}.$

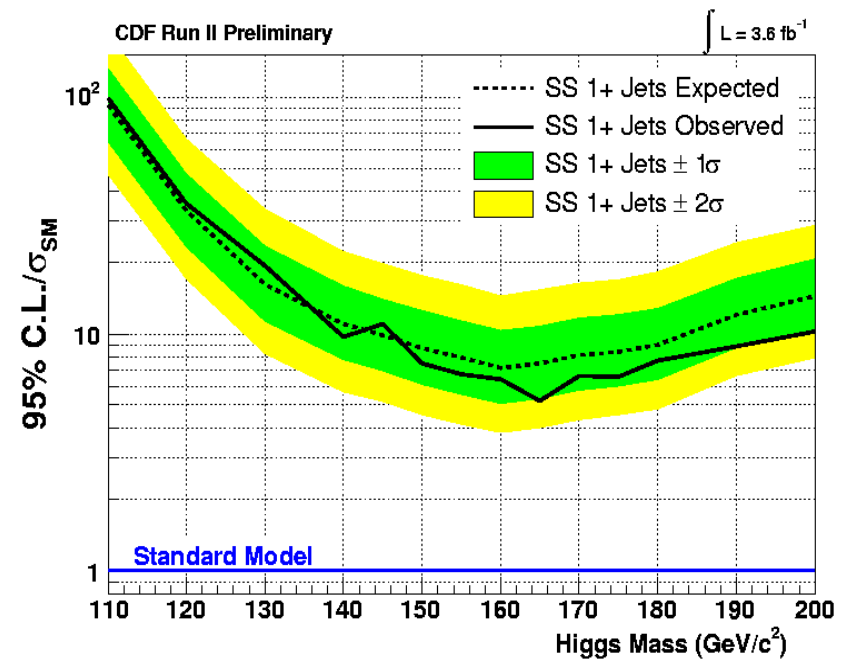
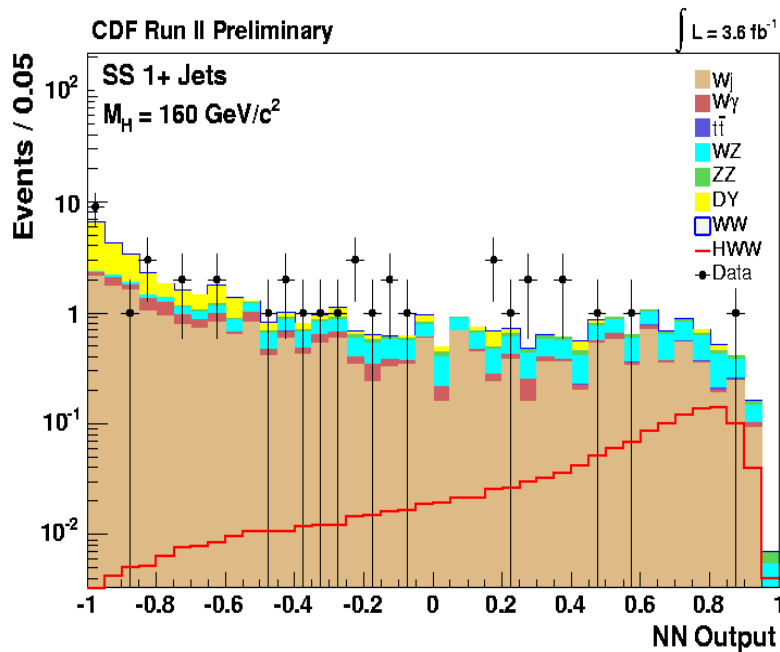

Tevatron High Mass Combination

- CDF and D0 results from *WW* and *WWW* channels are combined into single Higgs limit.
 - Bayesian and modified frequentist (CLs) methods using LLR test statistic.

$$LLR(M_H) = -2 \ln \frac{p(data|M_H)}{p(data|Null)}$$

- Correlated systematic errors taken into account.
- Most recent high mass combination includes results from summer 2008.

Tevatron High Mass Combination Result

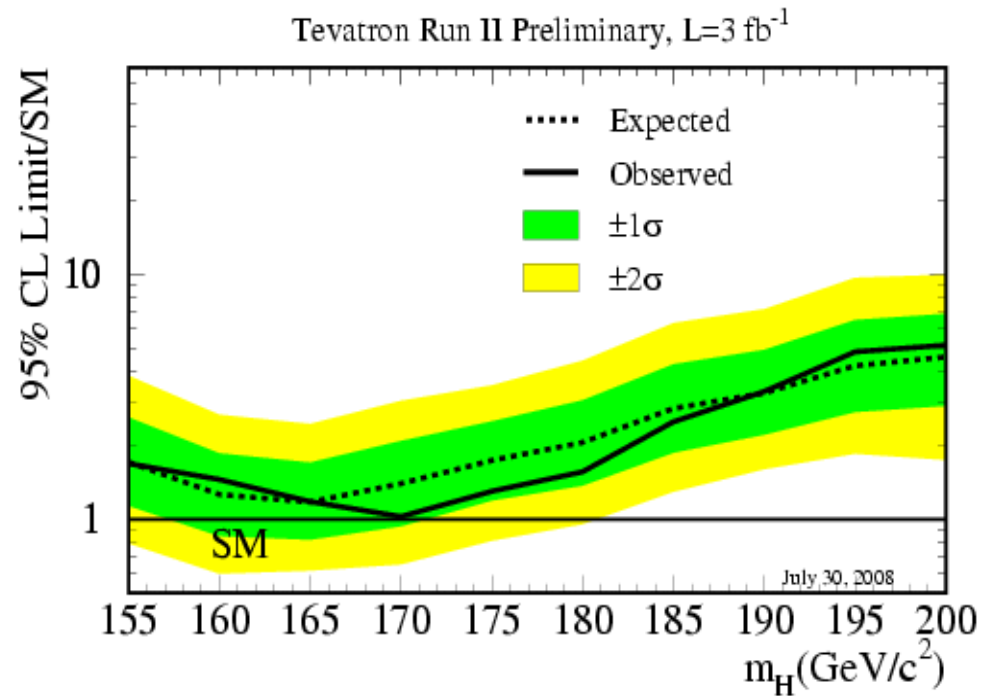
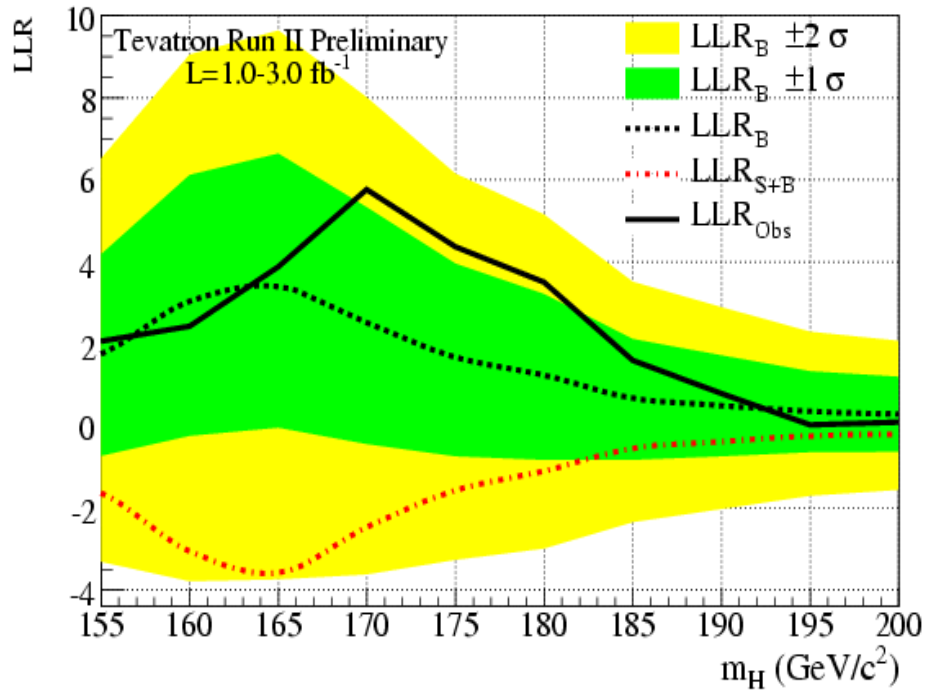

SM Higgs excluded at 95% CL for $M_H = 170$ GeV

Updated High Mass Combination Preview

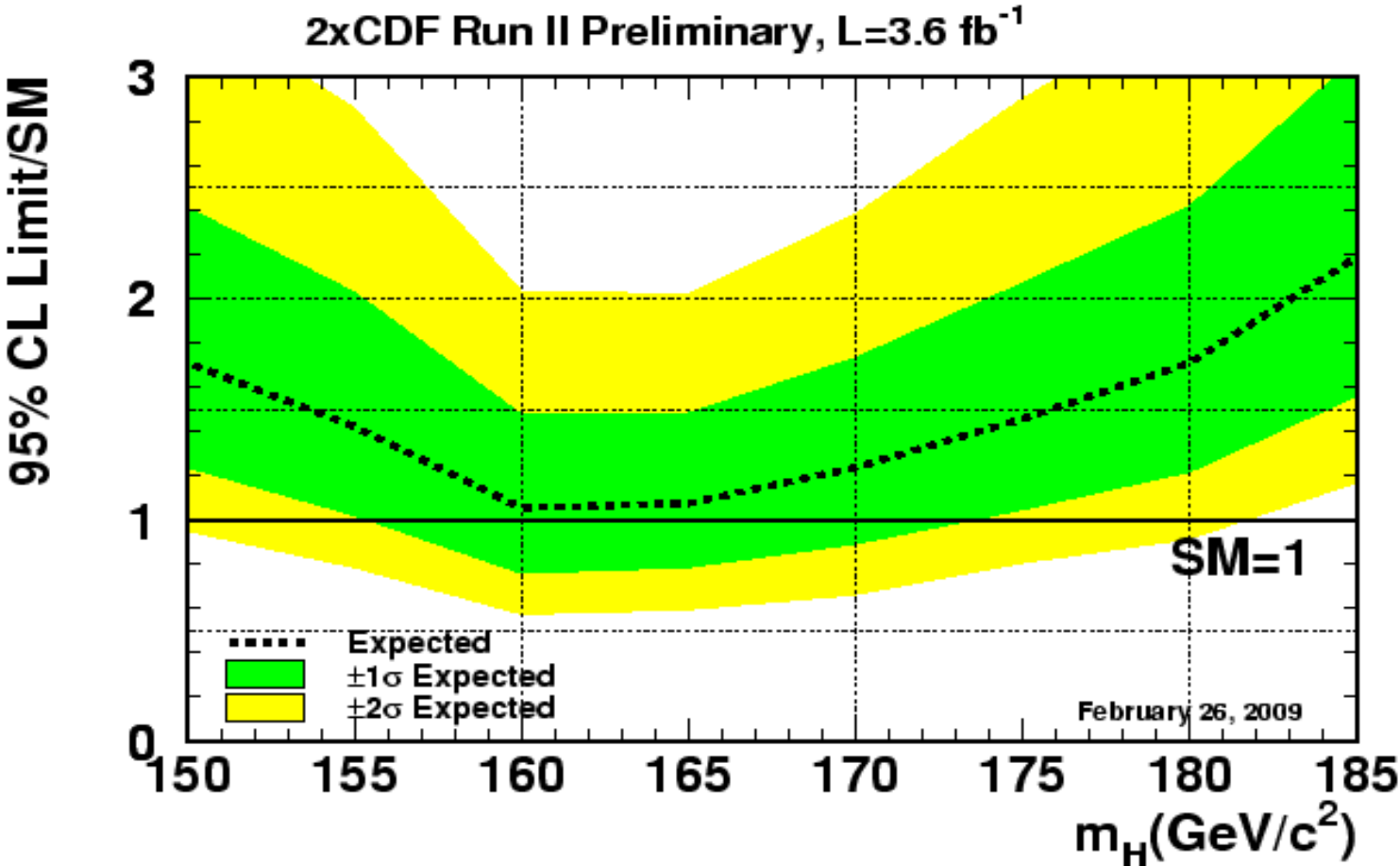

$$H \rightarrow \gamma\gamma$$

- Low branching ratio, but sensitive in intermediate mass range.
 - Flat sensitivity for intermediate mass $M_H \sim 120\text{--}130$ GeV.
 - Sensitive to gluon fusion production for low M_H .
 - Fermiphobic interpretation also available.
- Signature two high p_T γ 's.
- Backgrounds: $Z/\gamma^* \rightarrow ee$, γ +jets, dijet, nonresonant $\gamma\gamma$.
 - Nonresonant $\gamma\gamma$ is irreducible physics background.
- Strategies.
 - Good photon id.
 - Need best possible rejection of $e \rightarrow \gamma$ and jet $\rightarrow \gamma$ fake photons.
 - Look for narrow invariant mass peak.



$H \rightarrow \gamma\gamma$ Event Selection

- Require tight photon id and $p_T > 25$ GeV and $|\eta| < 1.1$.

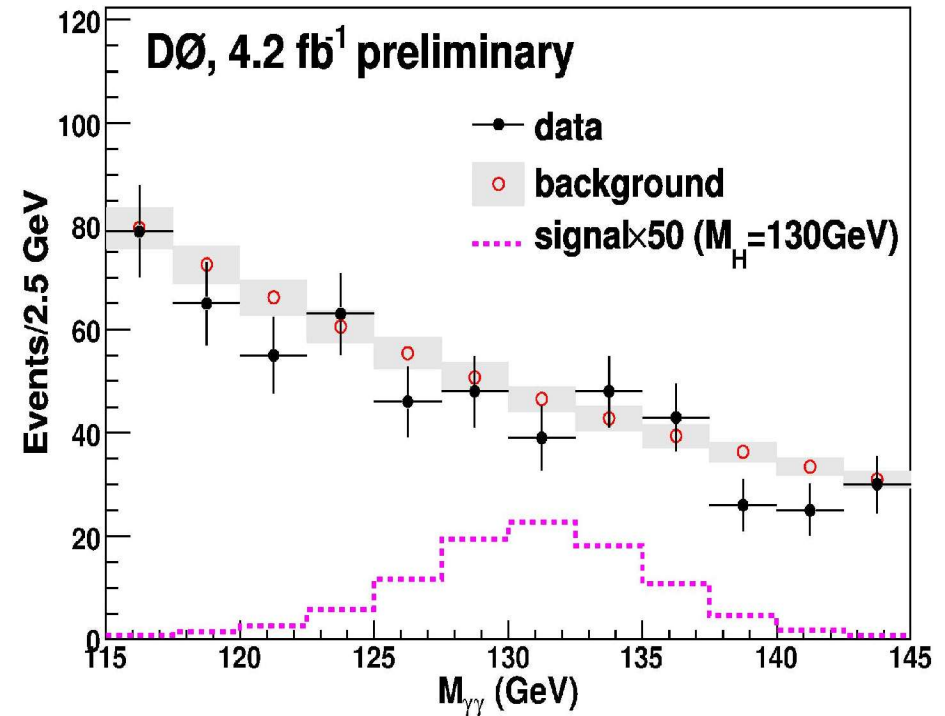
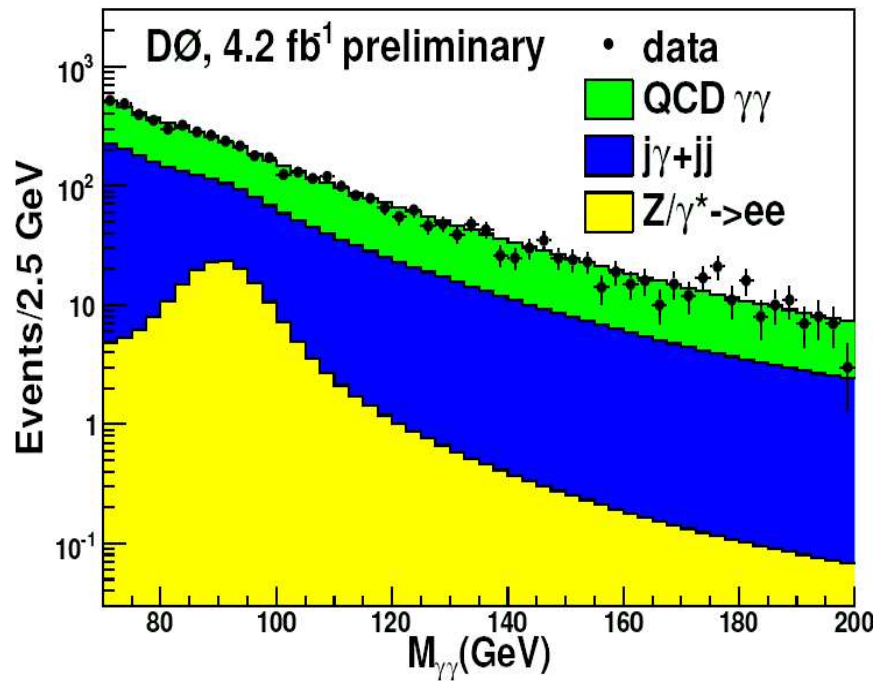



$H \rightarrow \gamma\gamma$ Result

- Limit extracted using expected lineshape.
 - Use sidebands around $M_H \pm 15$ GeV to fix background normalization.

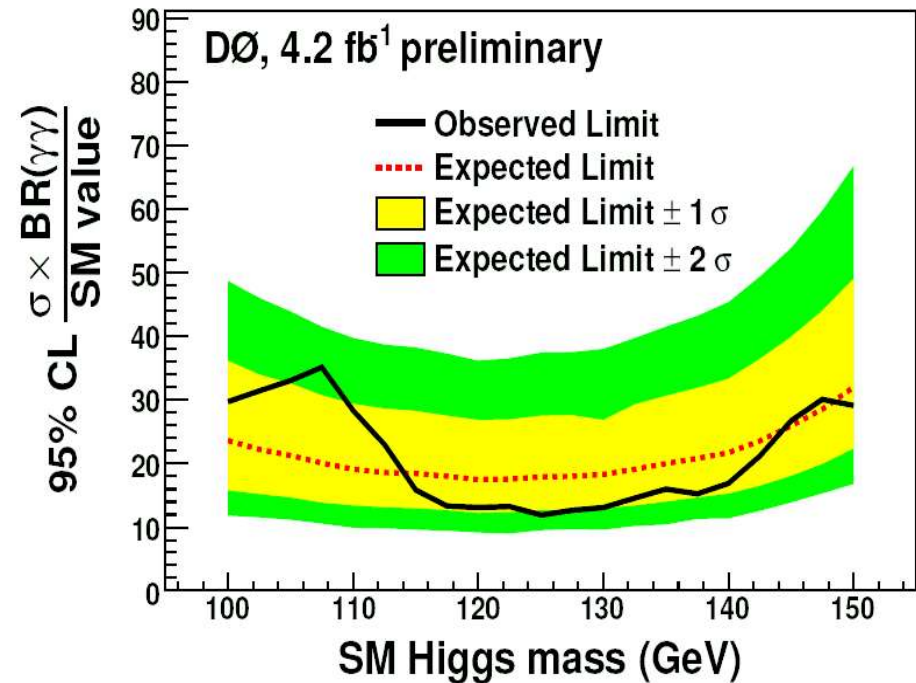
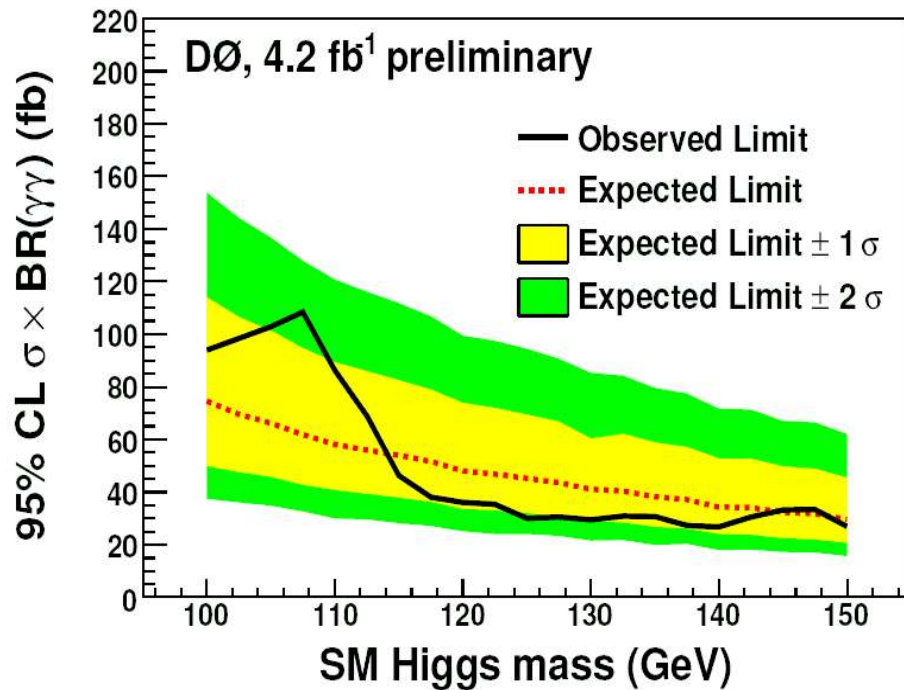

- Expected limit is 18.3 times SM at $M_H=130$ GeV.
- Observed limit is 13.1 times SM at $M_H=130$ GeV.

Prospects

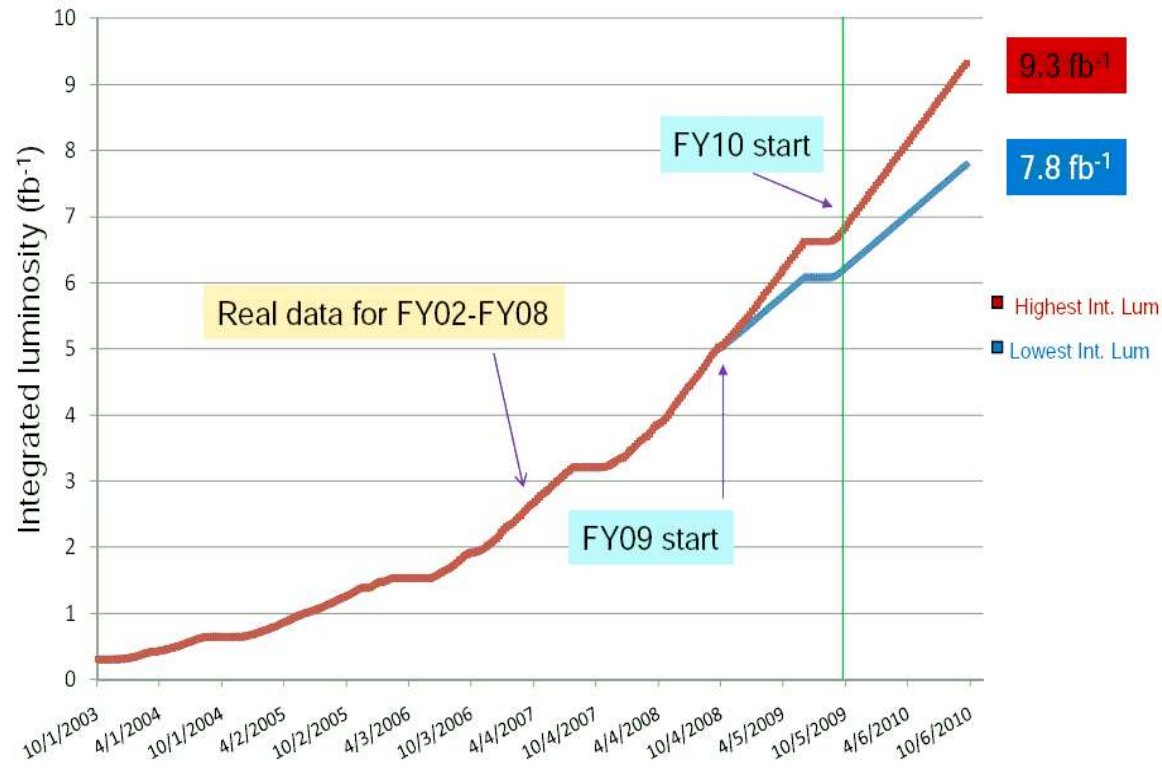

- Tevatron and experiments are running well.
- Experiments have $\sim 6 \text{ fb}^{-1}$ delivered today ($\sim 5.3 \text{ fb}^{-1}$ recorded).
- Expect $8\text{-}9 \text{ fb}^{-1}$ of integrated luminosity per experiment delivered ($7\text{-}8 \text{ fb}^{-1}$ recorded) by end of FY10 (more if Tevatron runs in 2011).
- Analysis improvements will likely improve Higgs sensitivity faster than luminosity scaling.

Summary

- SM Higgs excluded at 95% CL at $M_H=170$ GeV.
- Updated results with up to 4 fb^{-1} and updated Tevatron combination are expected soon.
- Tevatron and experiments are continuing to run well.
 - CDF and D0 currently have recorded about 5 fb^{-1} of data.
 - Expect $7\text{--}8 \text{ fb}^{-1}$ or more of analyzed data eventually.

Backup Slides

CDF Detector

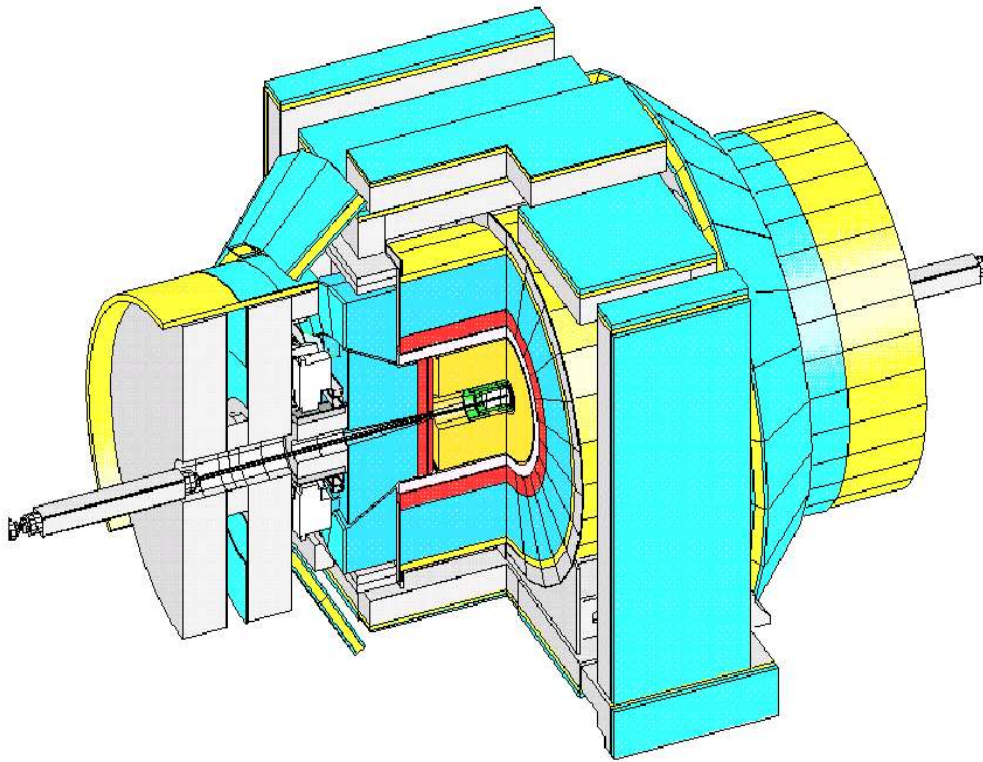

Tracking

Solenoid magnet

Silicon vertex detector

Wire drift chamber

$|\eta| < 2.5$

Calorimeter

$|\eta| < 4$

Muon system

$|\eta| < 1.5$

D0 Detector

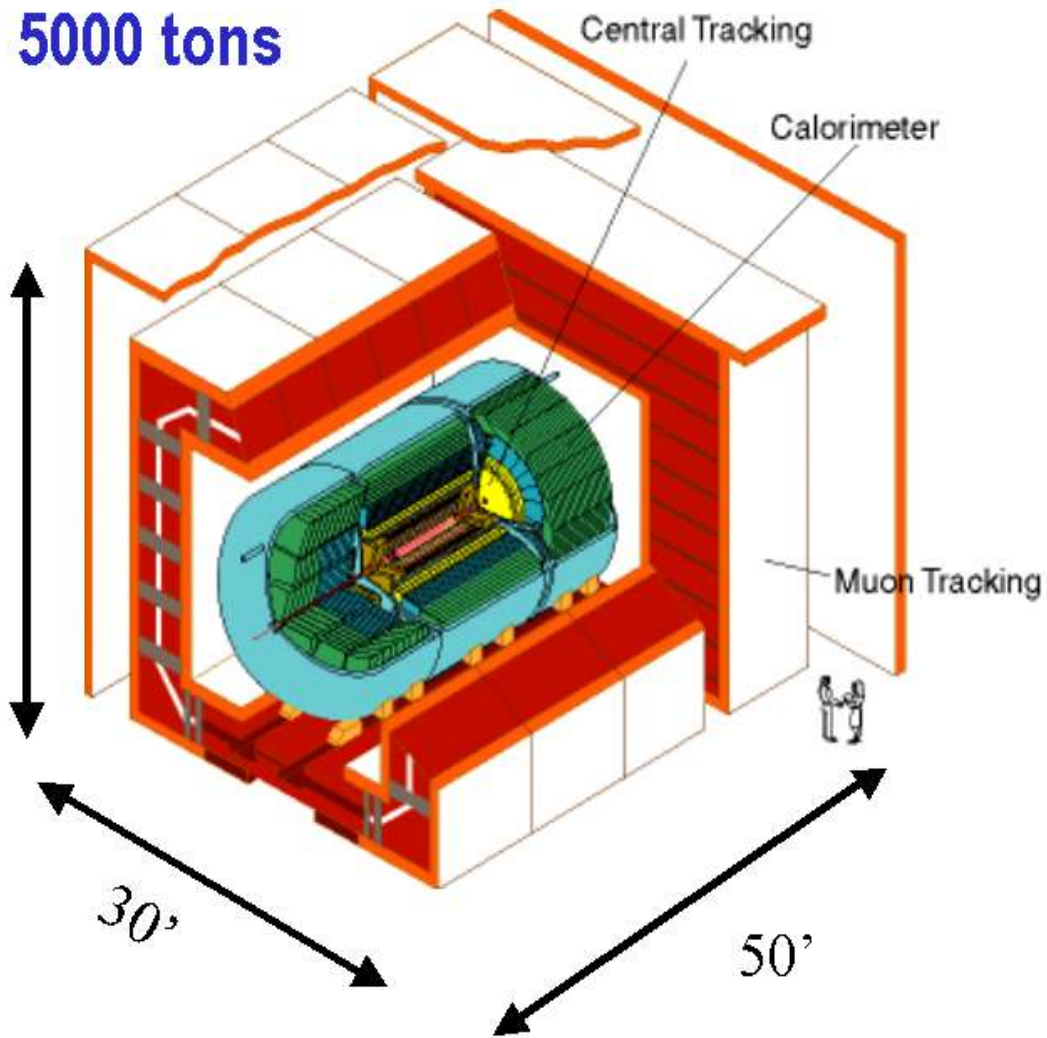

Tracking

Solenoid magnet

Silicon vertex detector

Scintillating fiber tracker

$|\eta| < 3$

LAr-U Calorimeter

$|\eta| < 4$

Muon system

$|\eta| < 2$

$H \rightarrow WW$ Systematic Errors



| Systematic Error | Signal (%) | Background (%) |
|-------------------------------|------------|----------------|
| Jet Energy Scale & Resolution | 0.3 | 1 |
| Lepton ID Efficiency | 5.7–8 | 5.7–8 |
| Jet ID Efficiency | | 6 |
| Theory σ 's | 4 | 5 |
| $p_T(Z)$ | | 1–5 |
| $p_T(W)$ | 6.8 | 3 |
| PDFs | 4 | 4 |
| Fake backgrounds | | |
| Integrated Luminosity | 6.5 | 6.5 |



$H \rightarrow WW$ Systematic Errors

| Systematic Error | Signal (%) | Background (%) |
|--------------------------------|------------|------------------|
| Jet Energy Scale | 4.6–8.7 | 1.1 |
| Lepton Energy Scale | 2.5–3.1 | |
| Lepton ID & trigger efficiency | 2 | 2 |
| Missing E_T modeling | 1 | 1–5 |
| γ Conversion modeling | | 20 ($W\gamma$) |
| Theory σ 's | 12 | 5–10 |
| PDFs | 5.1 | |
| Fake backgrounds | | 4 |
| Integrated Luminosity | 5.9 | 5.9 |

Tevatron High Mass Combination

90% and 95% CL Exclusions

