

Update on FDIRC full simulation

Alejandro Pérez
INFN – Sezione di Pisa

LNFB  Collaboration Meeting



Outline

- **The new beam-gas sample**
- **Beam-gas background rates on the FDIRC**
- **FDIRC shield studies**
- **Summary**

Beam-gas HER sample

- 285k primaries (losses) from beam gas HER backgrounds
- Total rate around the IP of 3.8MHz (Touschek-LER 58MHz)
- Run this sample with the code used for the Dec Production
⇒ **No FDIRC shield is included!**

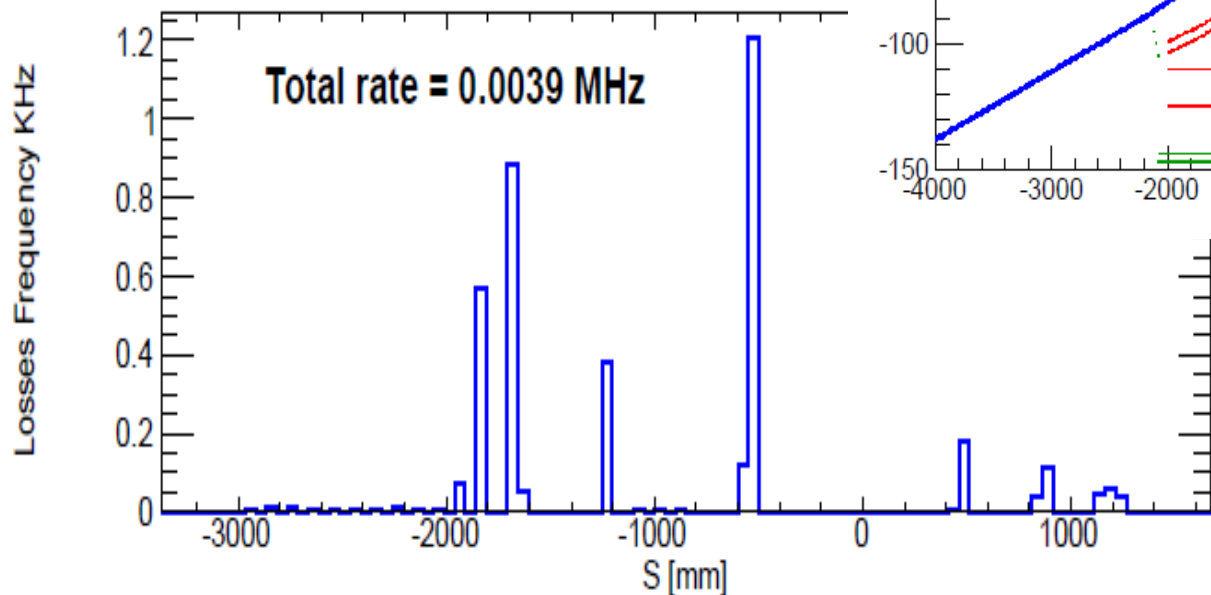
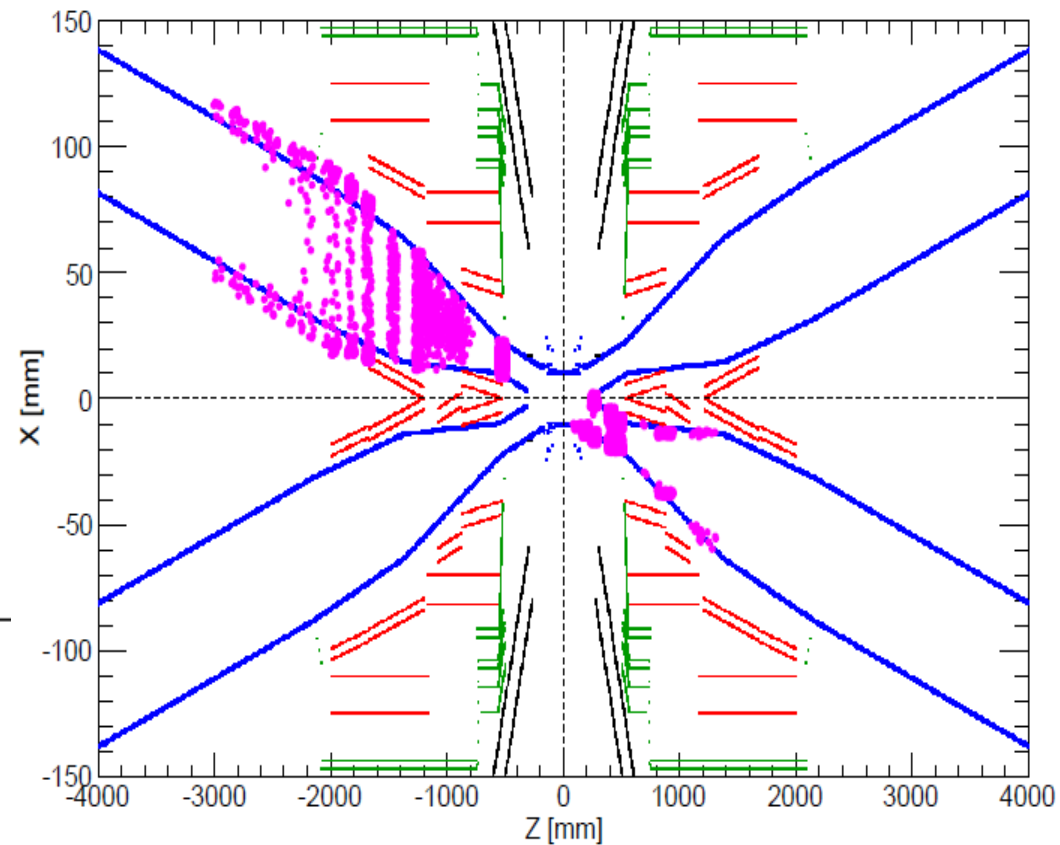

Latest FullSim production

- In Dec. 2011 were produced several background samples
 - Rad-bhabha
 - Pairs (2-photon)
 - Touschek HER/LER
- These samples were analysed for background estimates. See <http://agenda.infn.it/materialDisplay.py?contribId=49&sessionId=16&materialId=slides&confId=4107>
- Recently used the same code to run on the Beam-gas HER background samples
 - ⇒ Latest BRN developments, like the FDIRC shield, are not included

Bkg rates on the FDIRC: Strategy (I)

- Use same sector labelling as in BABAR
- Determine the photo-electron (p.e.) rates per pixel (see next slide) for every sector and for all available background sources
- Use a “local” coordinate system in the instrumented plane: X_{local} vs Y_{local}

Hits location for Rad-bhabha

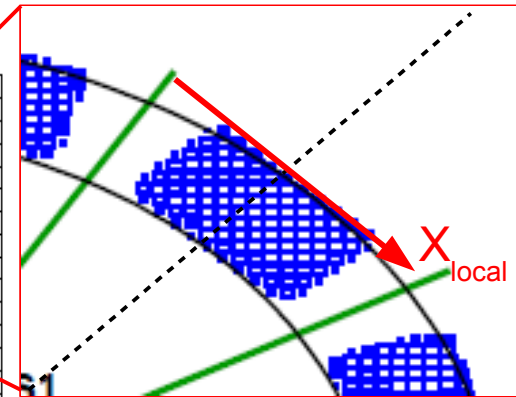
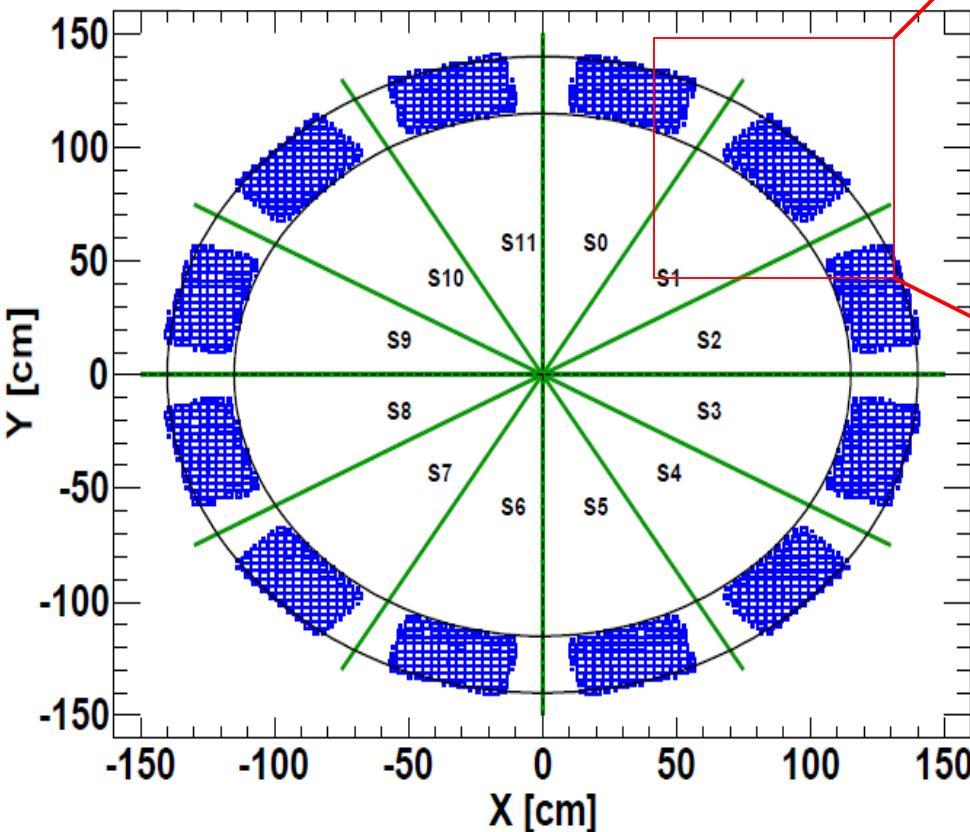

X_{local} :
From $-width/2$
up to $width/2$

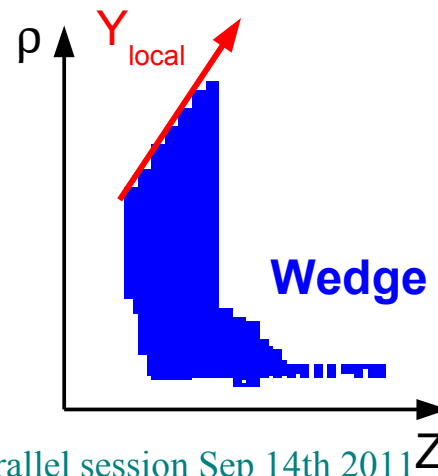

Y_{local} :
From 0.0
up to Length

Bkg rates on the FDIRC: Strategy (II)

- Study the pixel rate for different regions where the tracks hit the quartz bar:
 - (a) Inside magnet: $-160 < Z < 220$ cm
 - (b) Within steel: $-280 < Z < -160$ cm
 - (c) Outside magnet: $-280 < Z < -400$ cm
- If main contribution comes from outside magnet
⇒ can reduce backgrounds by increasing shields

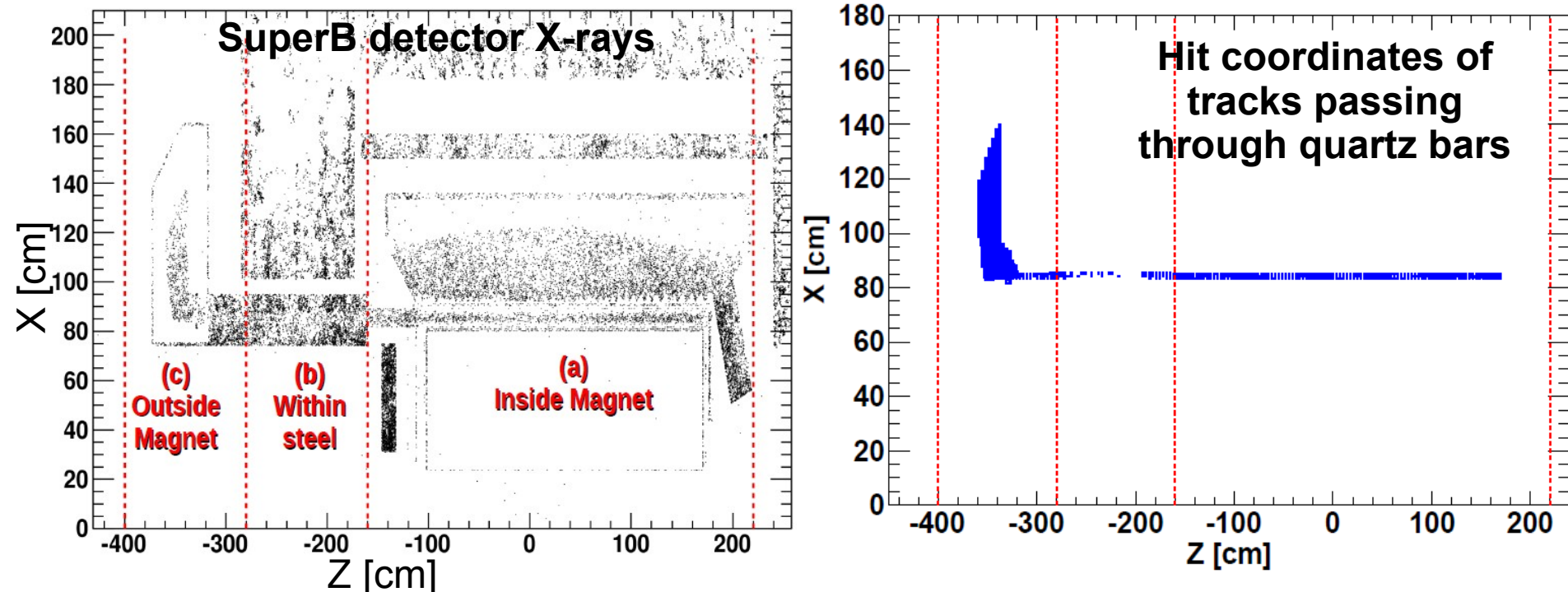

Bkg rates on the FDIRC: Pixel map

- For each sector have an array $8 \times 6 = 48$ photo-detectors
- Each detector is an $8 \times 8 = 64$ array of PMTs (pixels) with $\sim 6.08\text{mm}$ pitch

Group 2 channels into one = 32 channels

pixel map w.r.t local coordinates

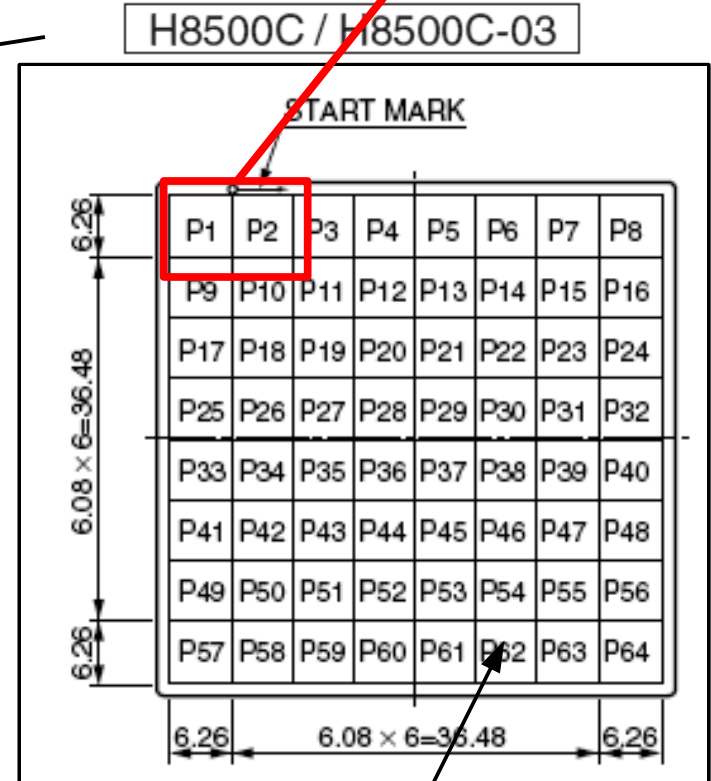
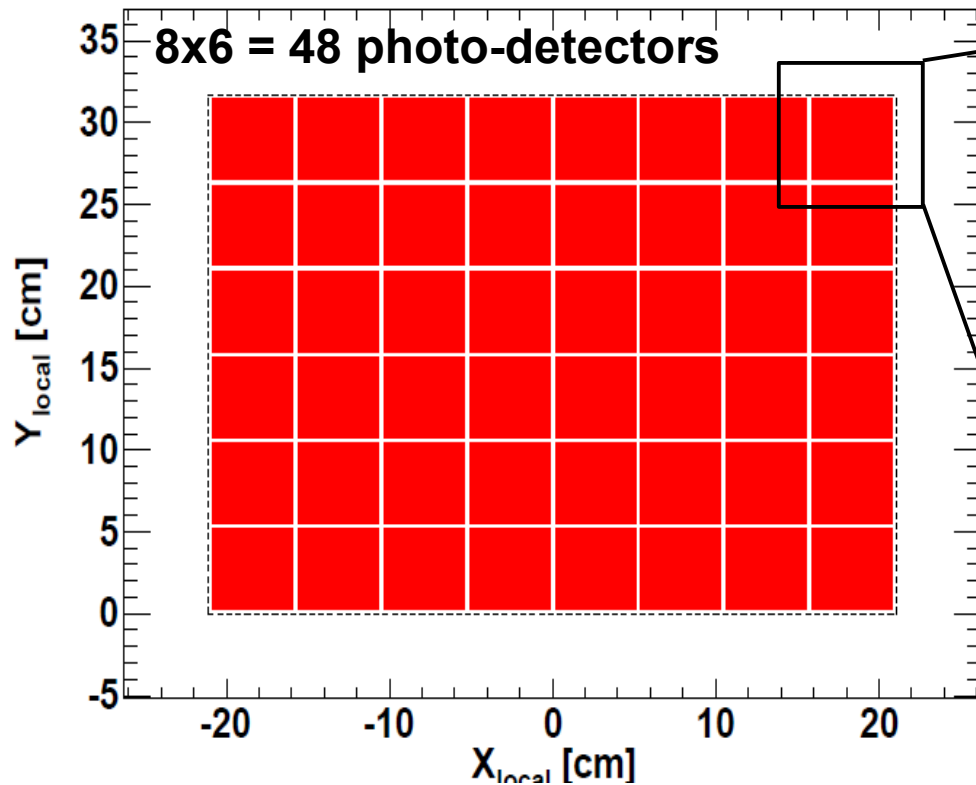

FDIRC Bkg rates from Beam-gas HER (I)

Sector 6

Inside Magnet

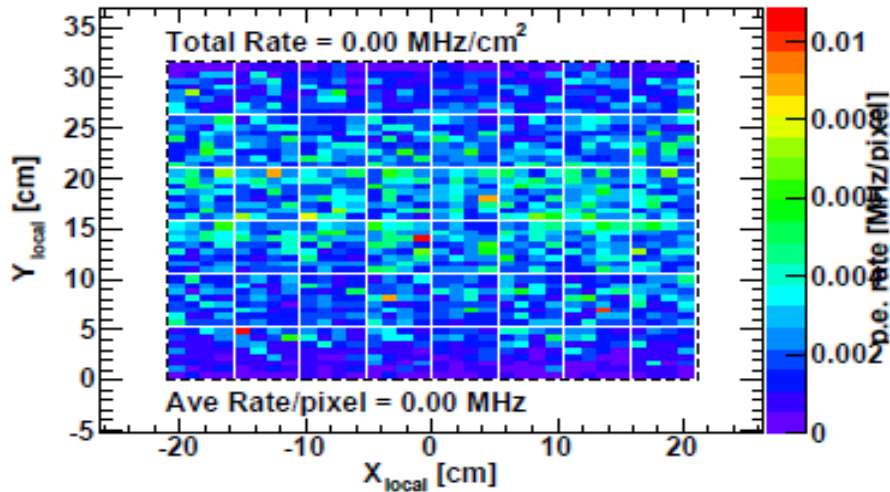

Within Steel

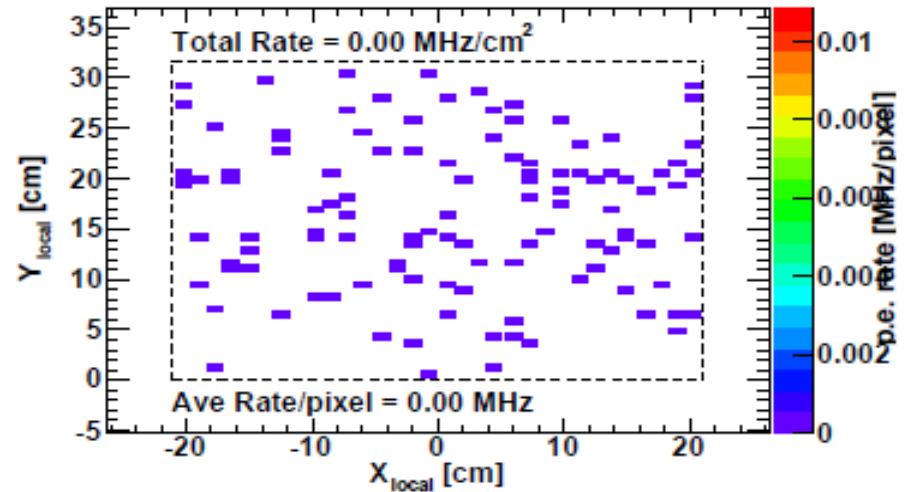

Outside Magnet

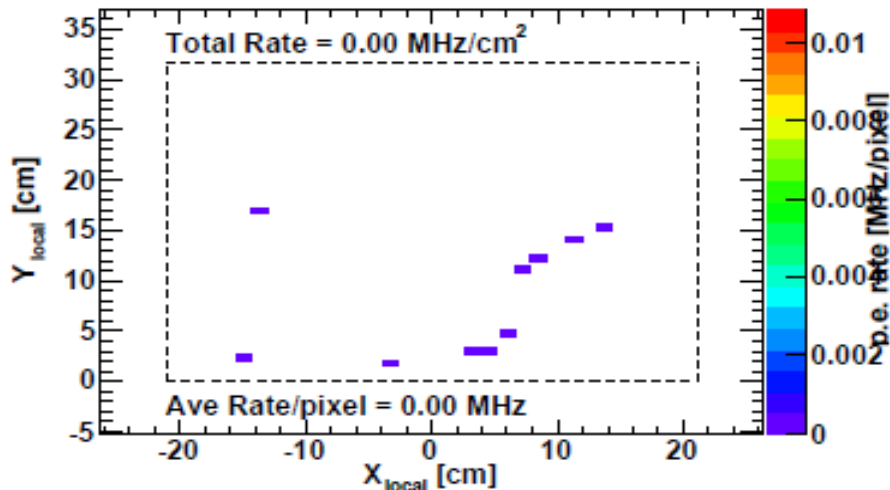

Total Rate

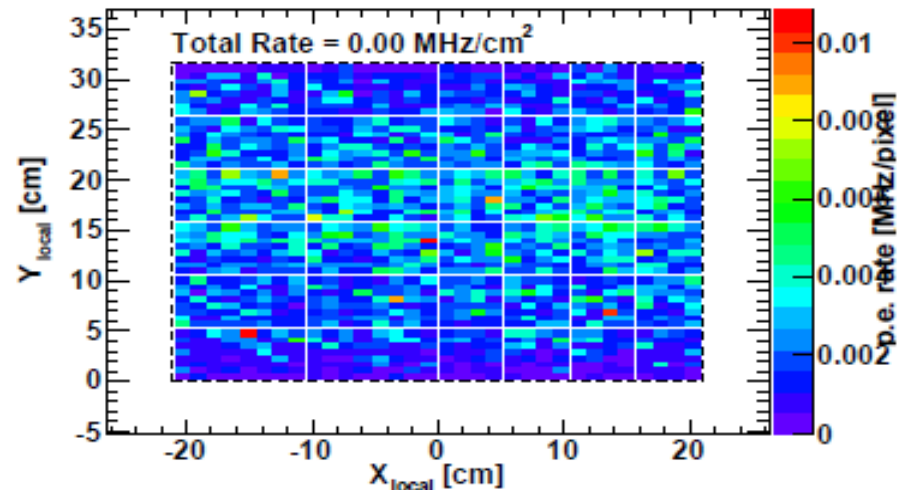

FDIRC Bkg rates from Beam-gas HER (II)

Total Rate per sector

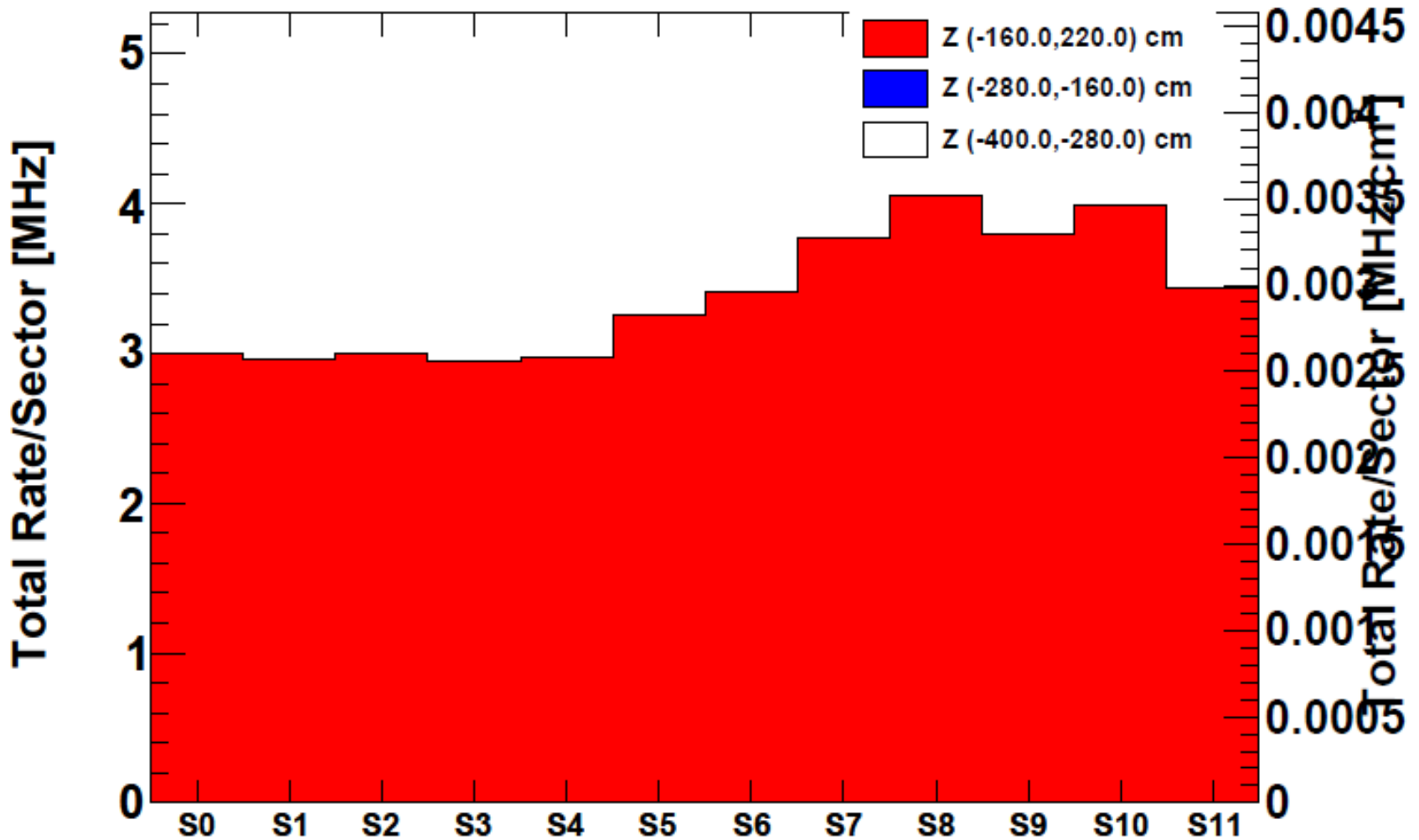

Total bkg rates on FDIRC

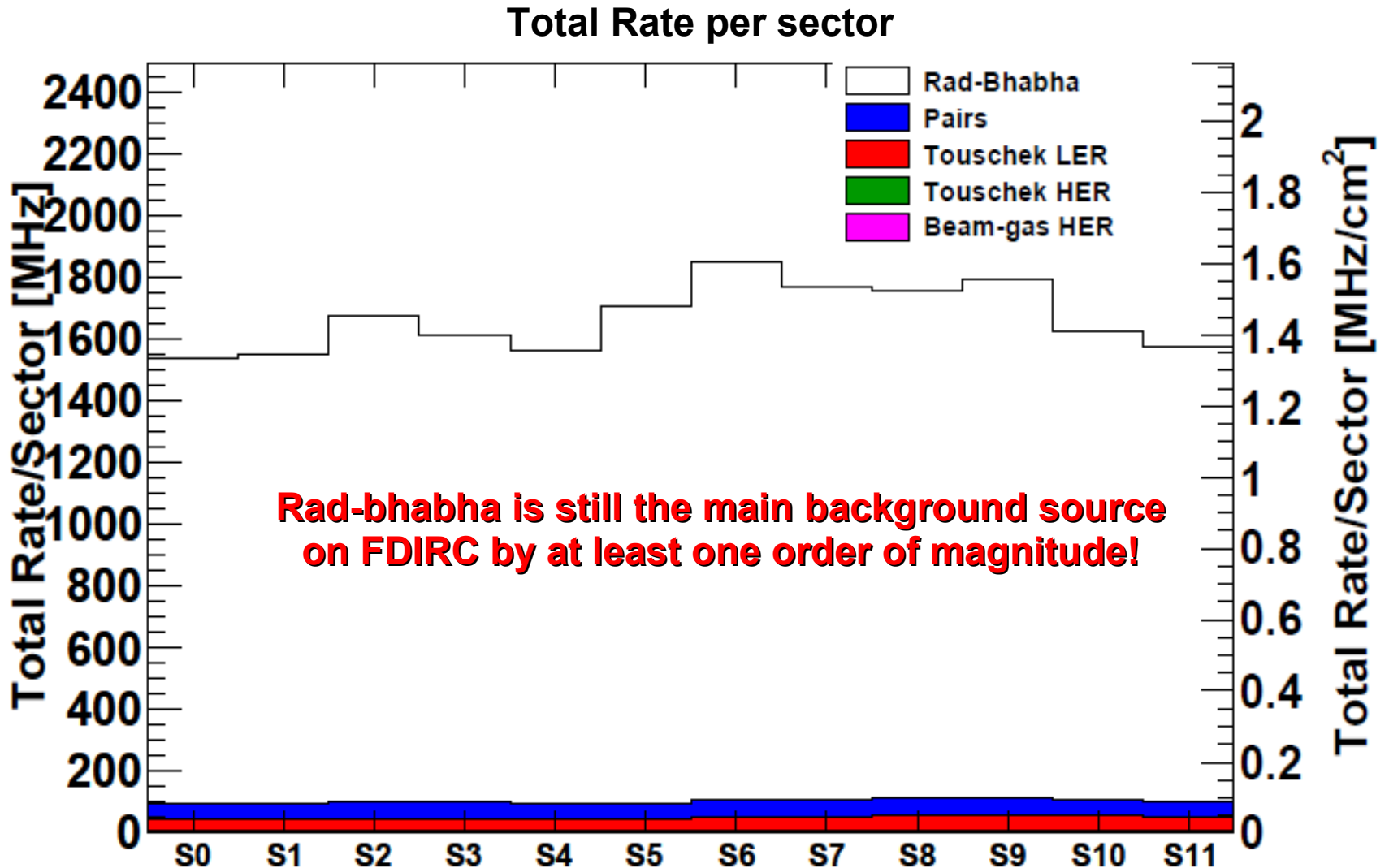

Total bkg rates on FDIRC

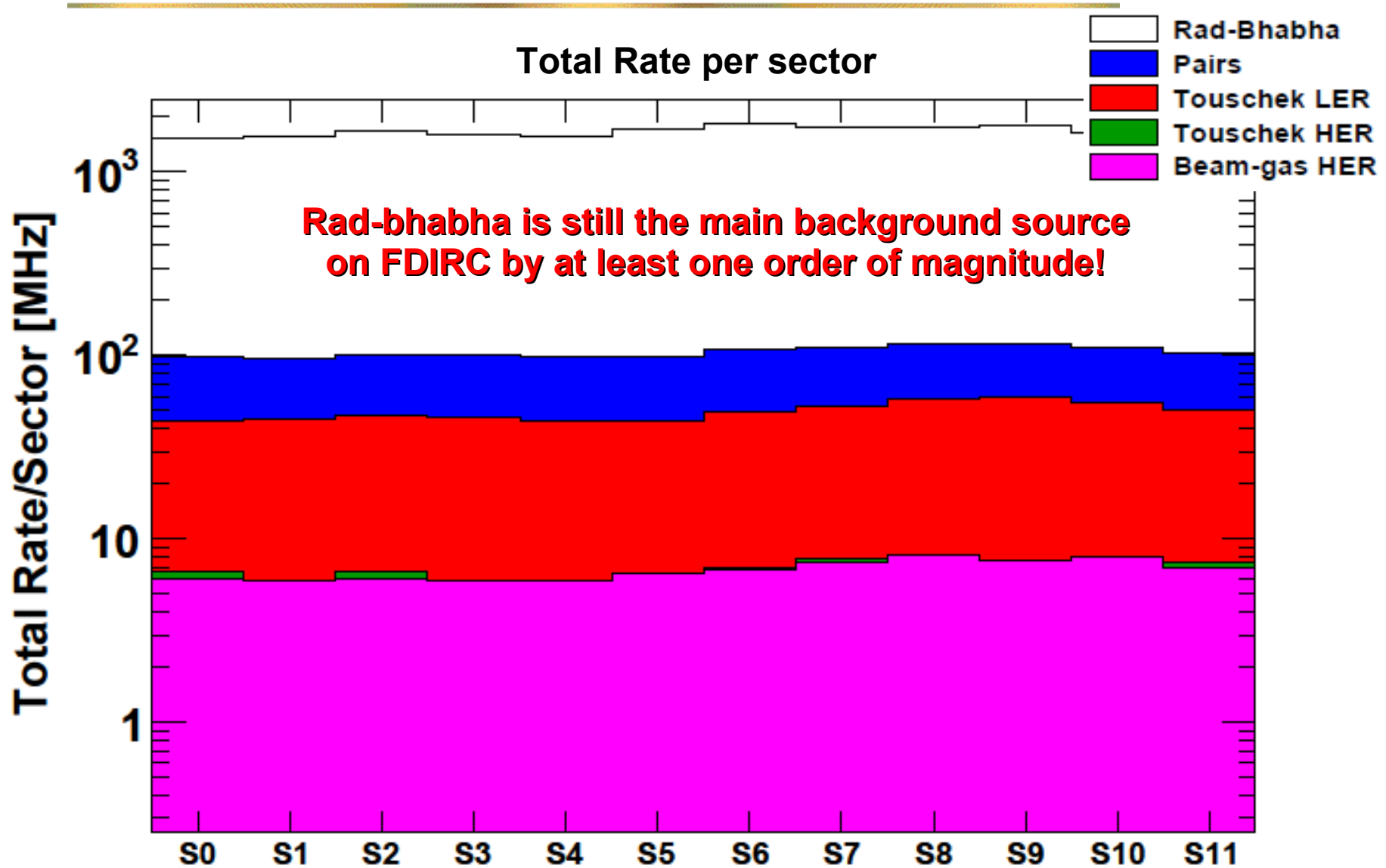

FDIRC Bkg rates from Rad-Bhabha

Total Rate per sector

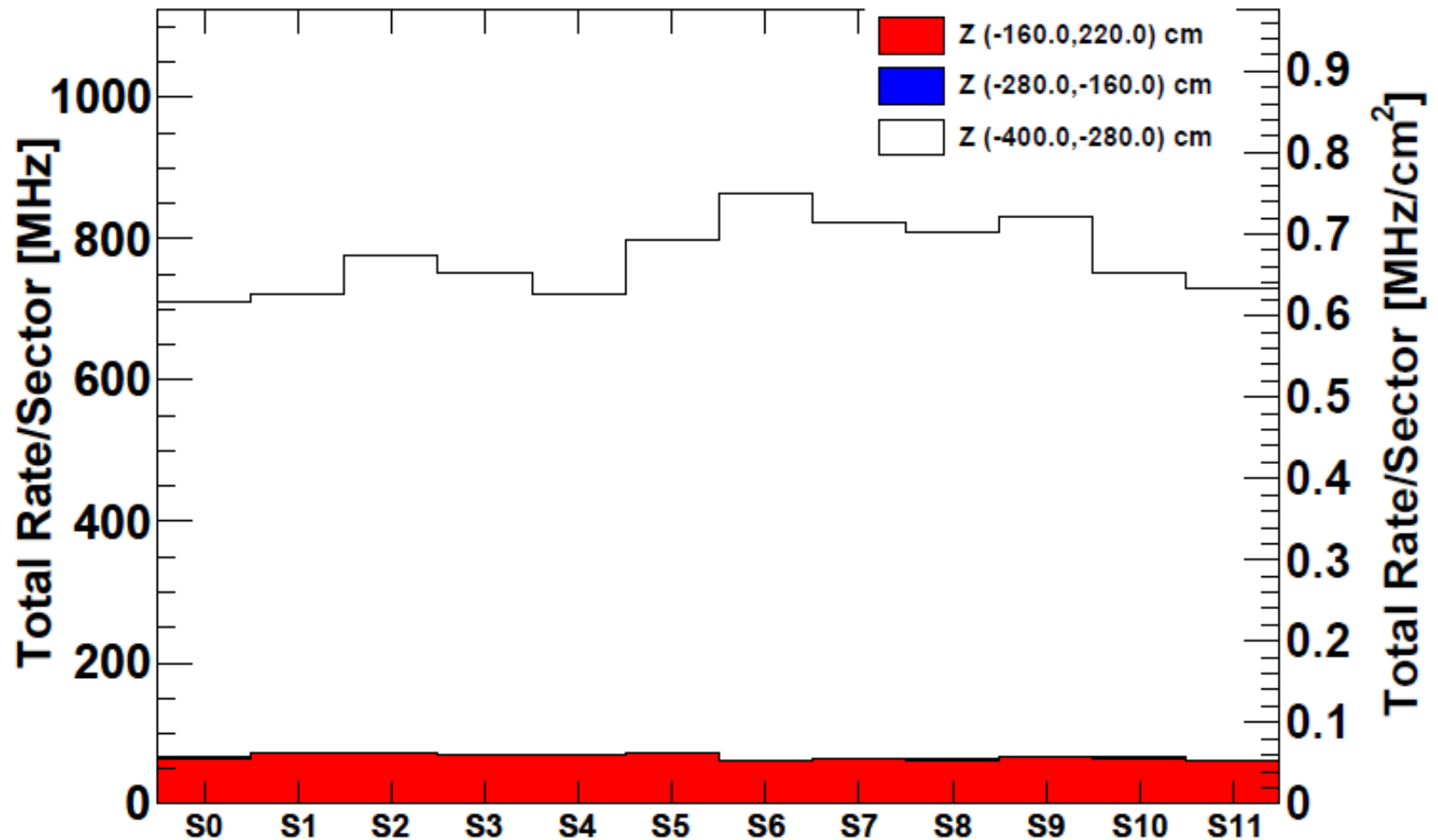

Particle flux studies (I)

- Study the flux of particles through interesting regions of the the FDIRC mother boundary (magenta and green regions)
- Try to understand the nature of the particles crossing those boundaries (PID and spectrum)

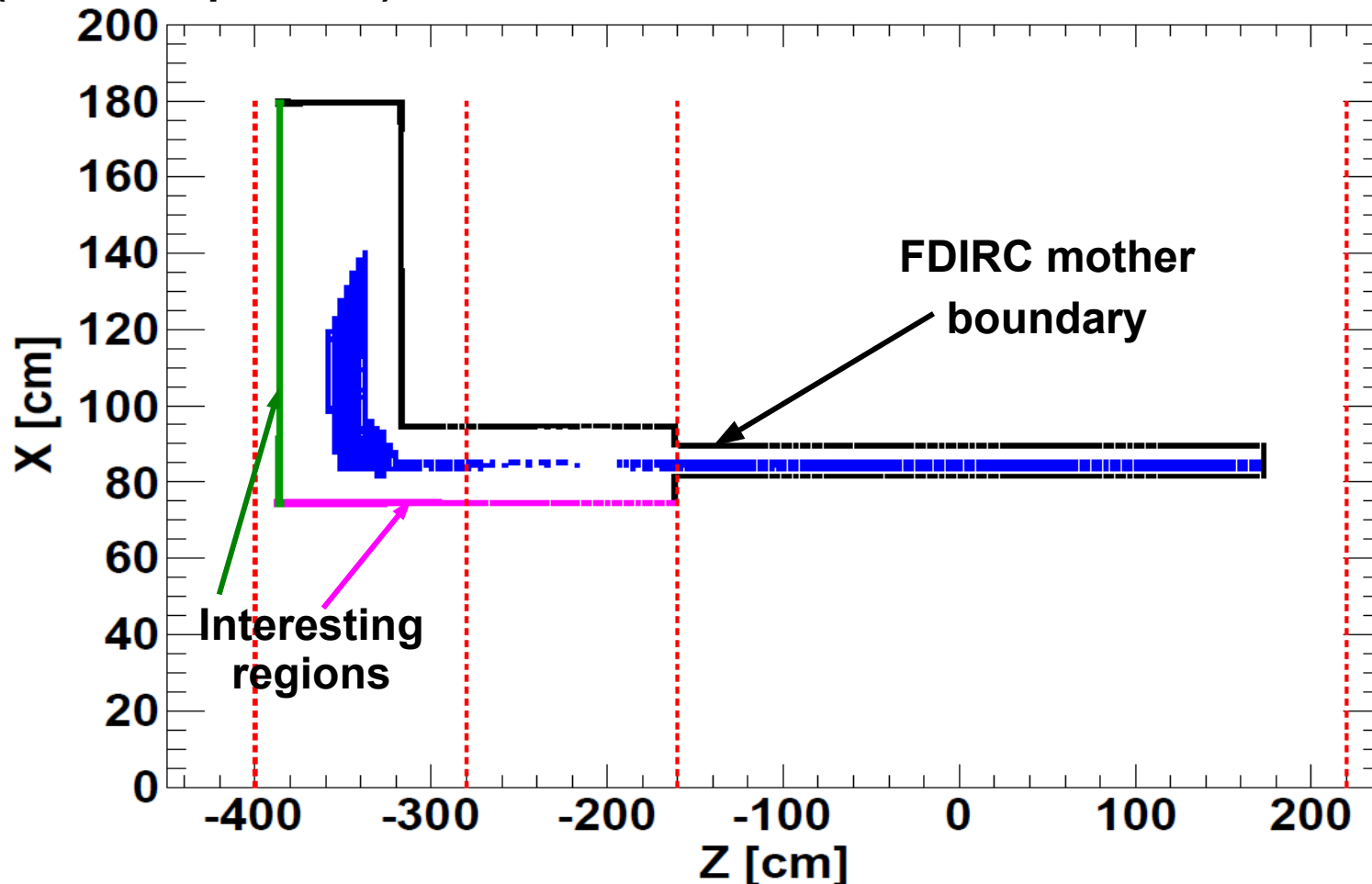

Particle flux studies (II)

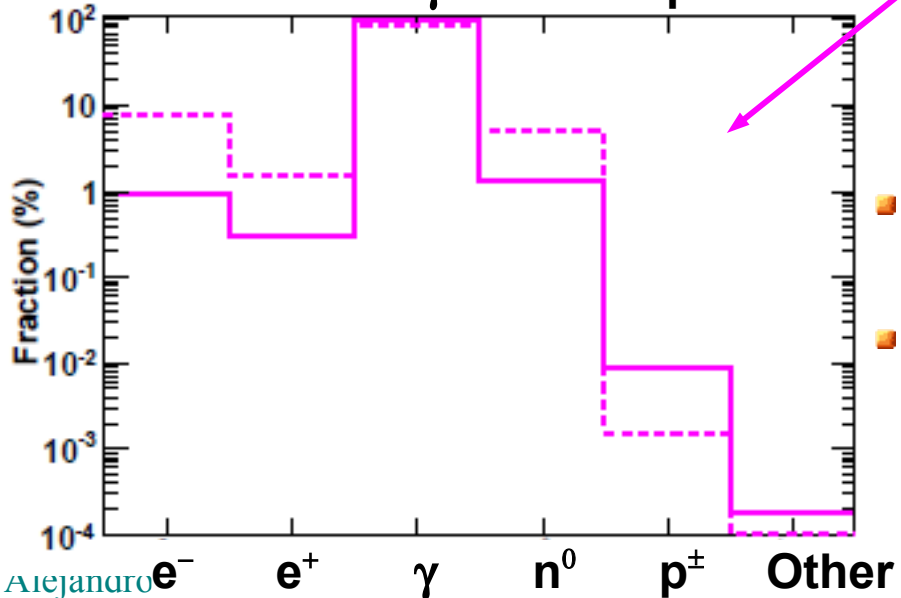
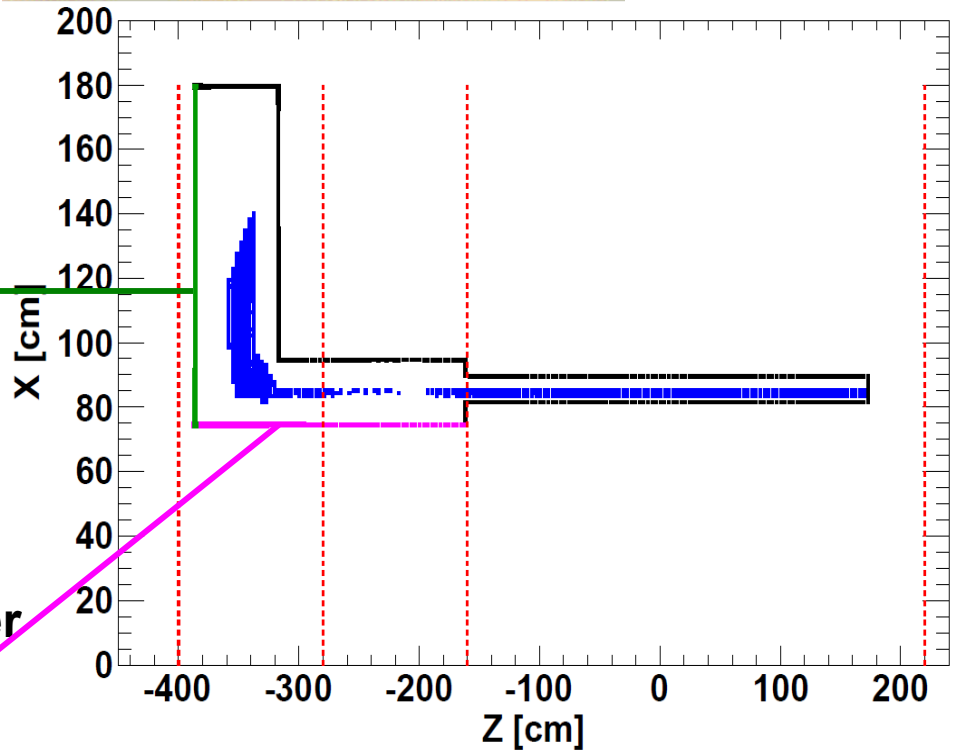
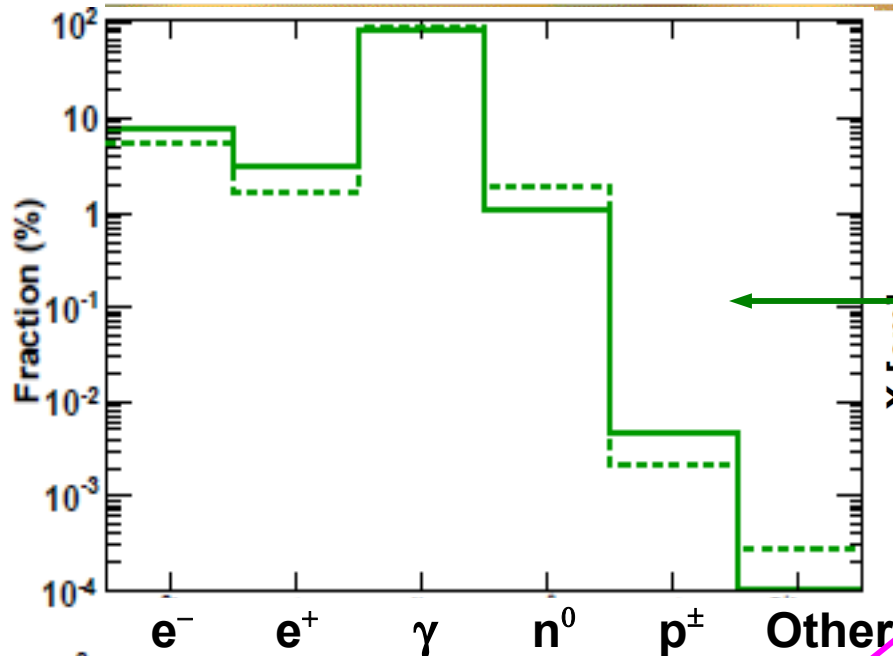

- The main contribution to the flux are γ (~90 – 98%) and e^\pm (1-10%)
- In the second place are neutrons (~1%)

Particle flux studies (III)

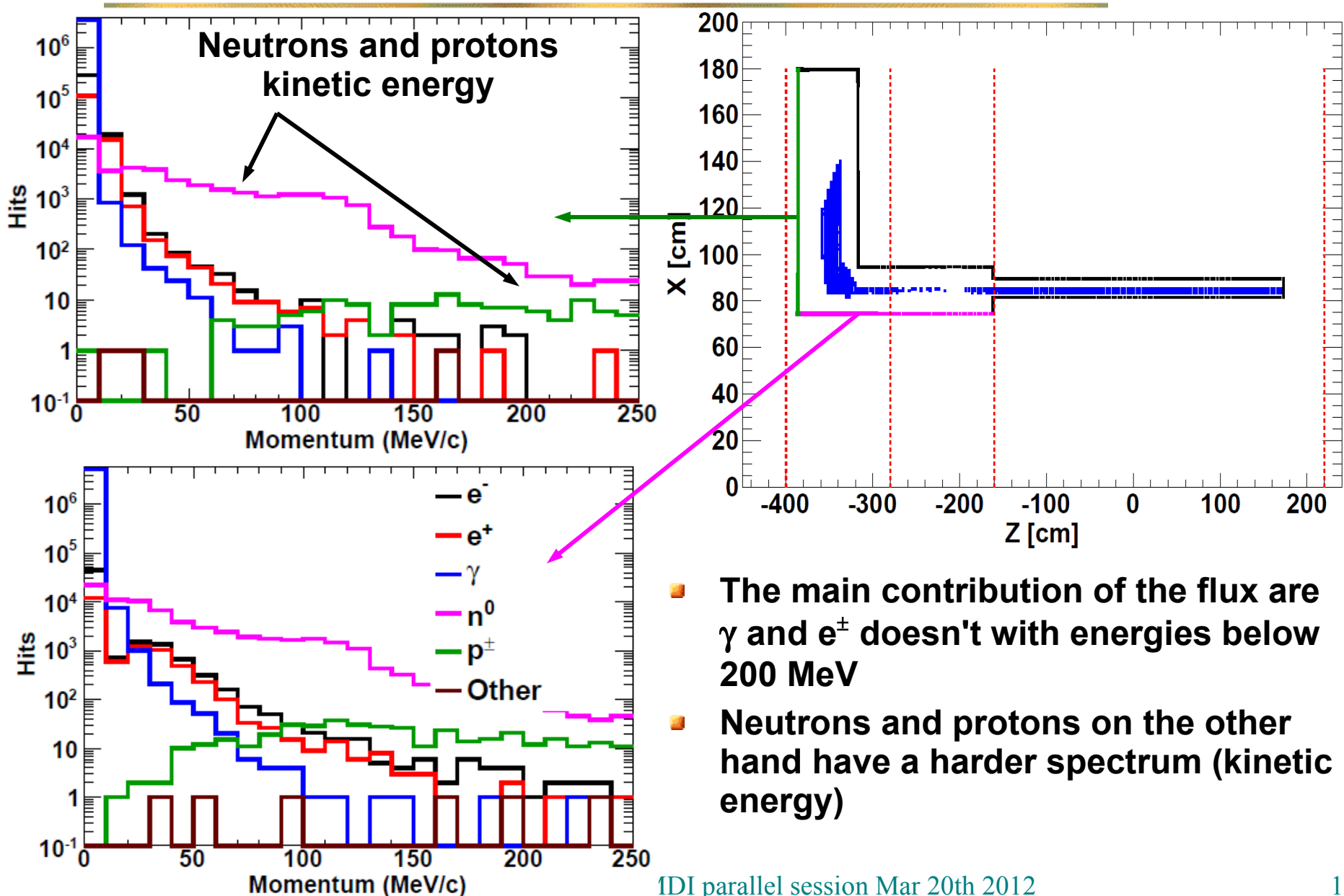

Particle flux studies (VI)

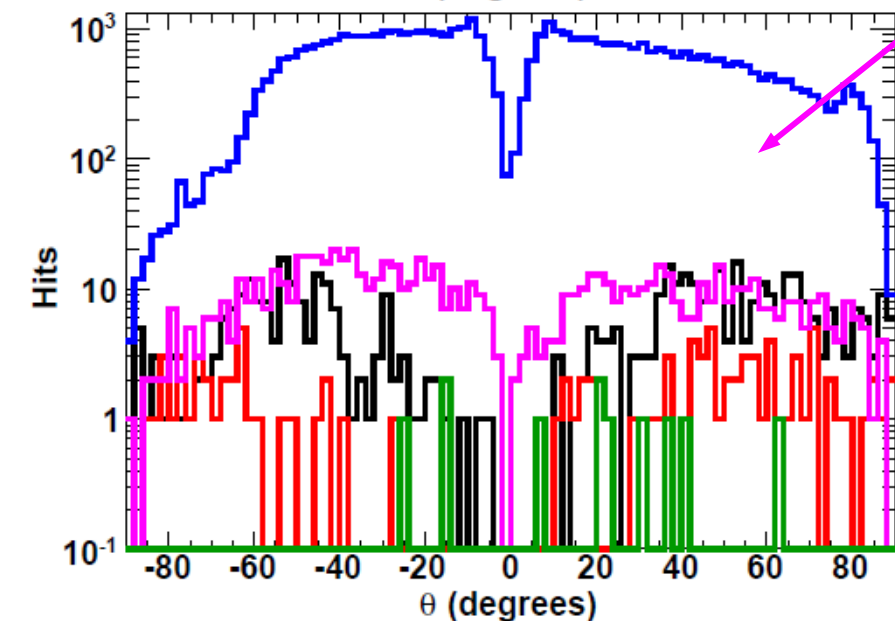
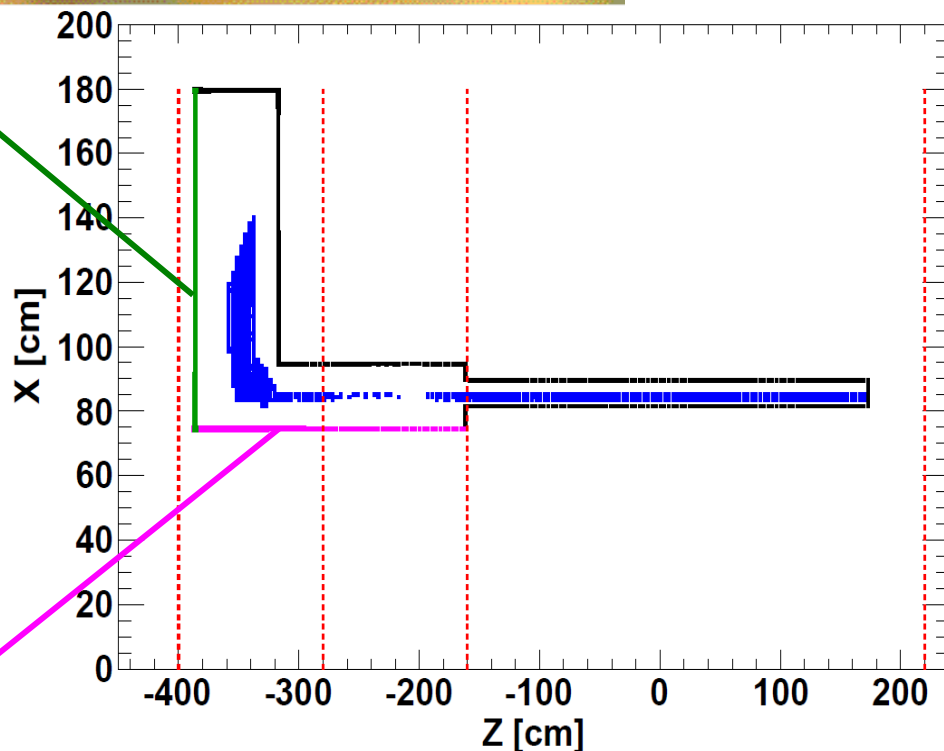
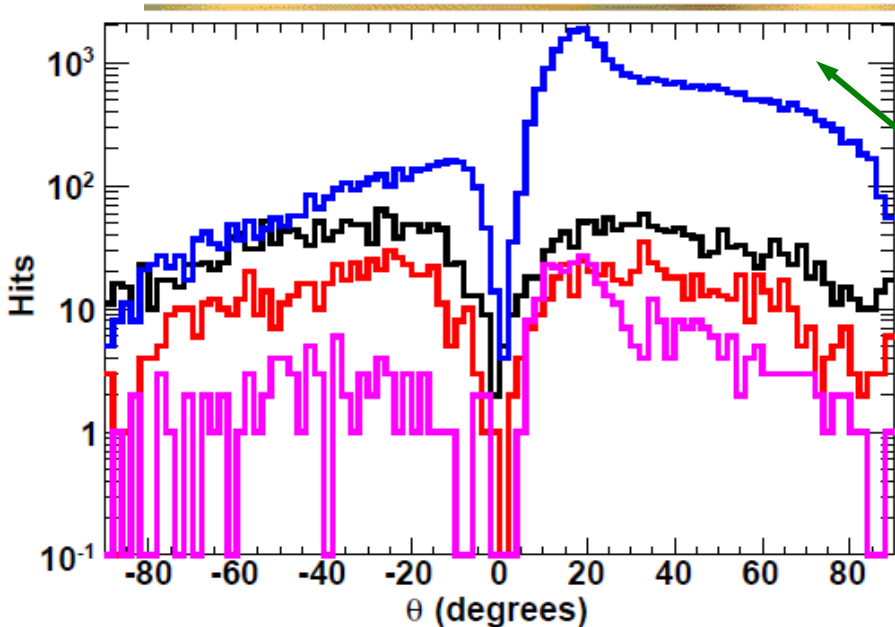

- Incident angle:
 - $\theta = 0$ means normal incidence
 - $\theta > 0$ means particles coming more or less from the IP
- Most of the particles have a non-normal incidence

Lead shield optimization studies (I)

- **Shot particles (e^\pm , γ , n^0) at normal incidence on Lead for**
 - Different lead thickness: 5 – 20 cm (1cm steps)
 - Different incident energies: 50 – 200 MeV (50MeV steps)
- **Study the particle multiplicity and spectrum at the other end of the shield**
- **Optimization: thickness for which the probability to have more than one particle on the other side of the shield is lower than 10%**

$$\text{Probability}(\text{Multiplicity} > 0) \leq 10\%$$

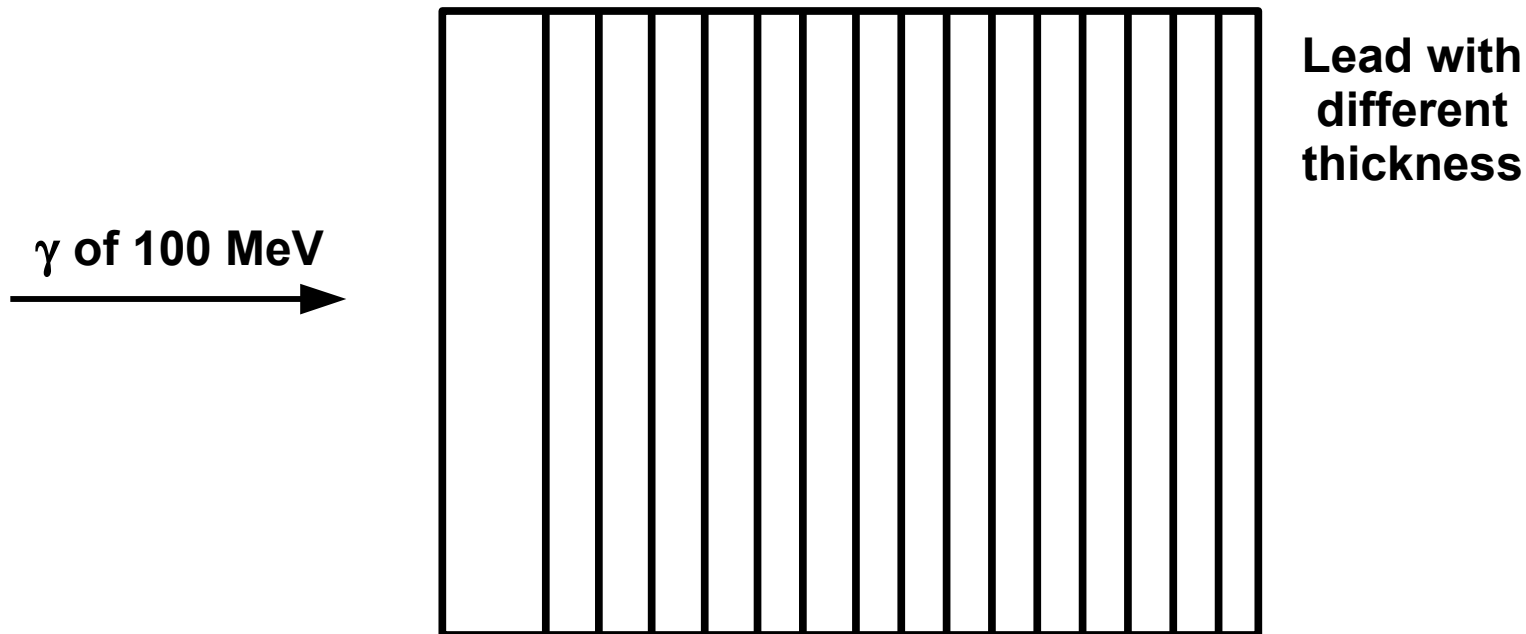

Lead shield optimization studies (II)

Incident photons

Total Average multiplicity vs Shield Thickness

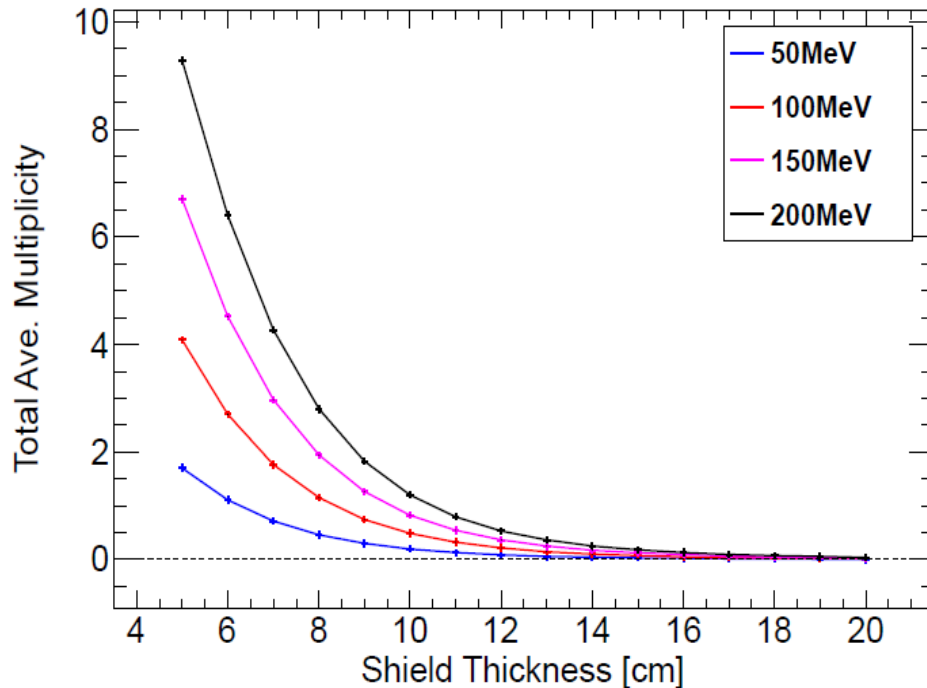

Total Prob(Multiplicity > 0) vs Shield Thickness

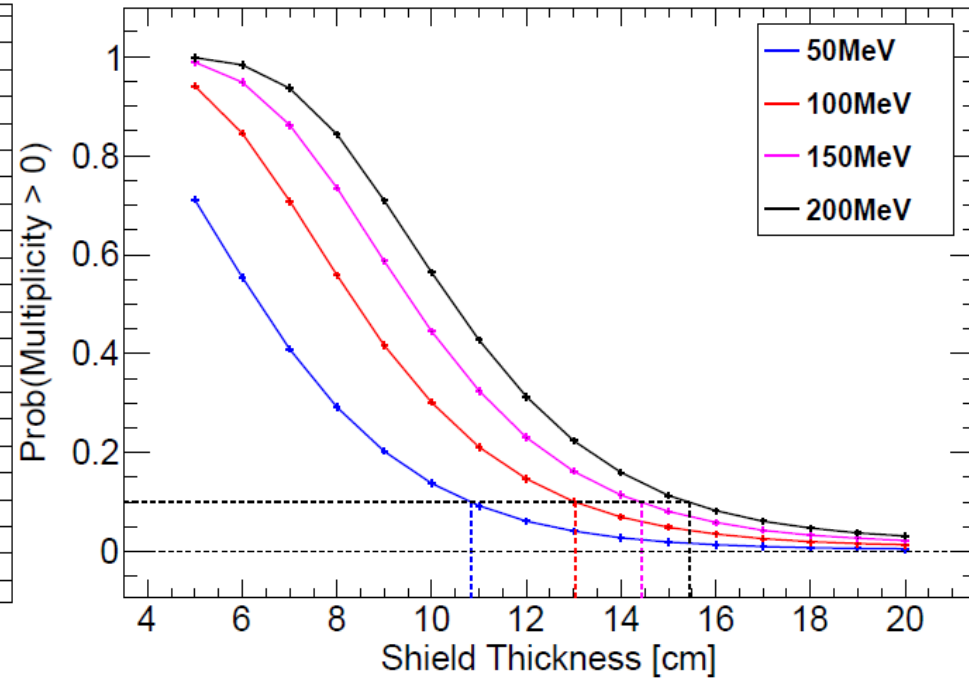

- Multiplicity at the other end of the lead shield due mainly to photons and electrons/positrons (very small contribution from neutrons)
- Higher the energy of the incident photon, thicker must be the lead shield

Lead shield optimization studies (II)

Incident photons

Total Average multiplicity vs Shield Thickness

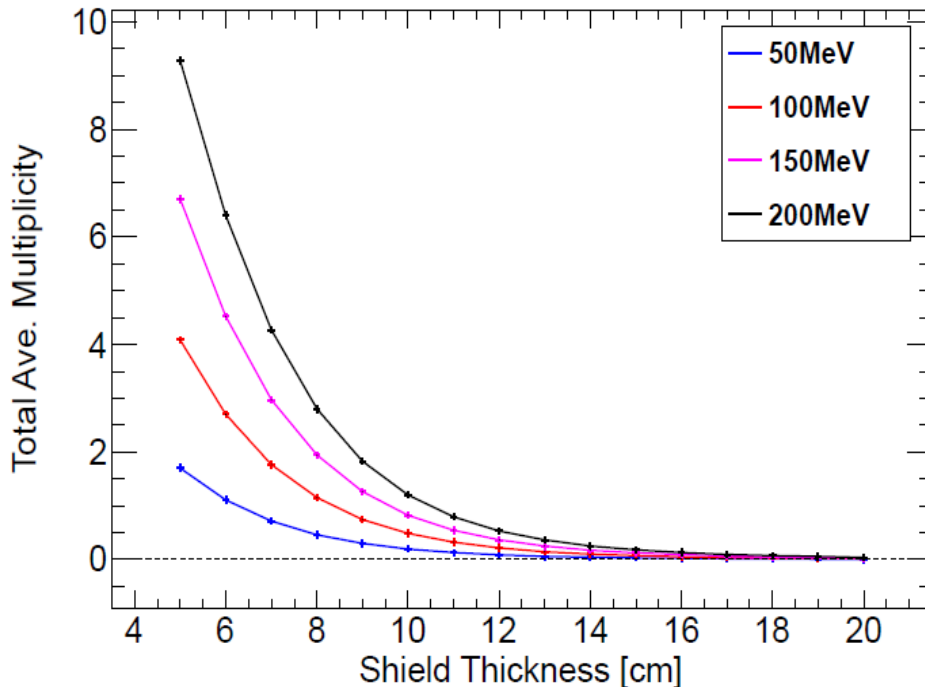

Optimal Thickness for Prob(Mul. > 0) = 10% vs Energy

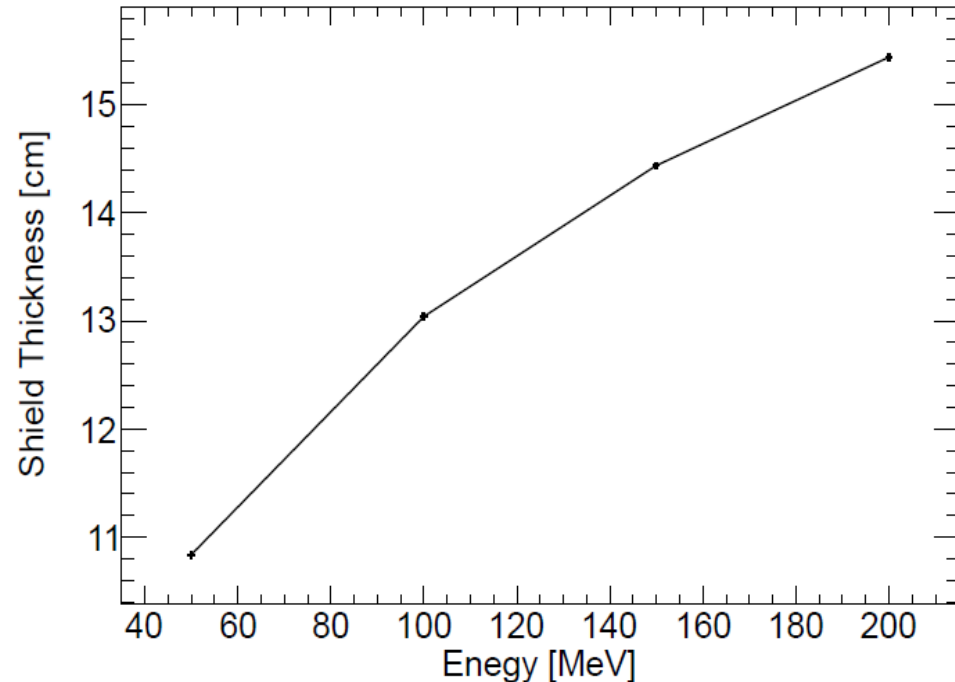

- Multiplicity at the other end of the lead shield due mainly to photons and electrons/positrons (very small contribution from neutrons)
- Higher the energy of the incident photon, thicker must be the lead shield
- In order to reduce the photon flux by a factor of 10 for photons up to 150 MeV, the lead shield thickness needs to be 14.4 cm

Lead shield optimization studies (III)

Incident neutrons (neutron multiplication)

Average multiplicity vs Shield thickness

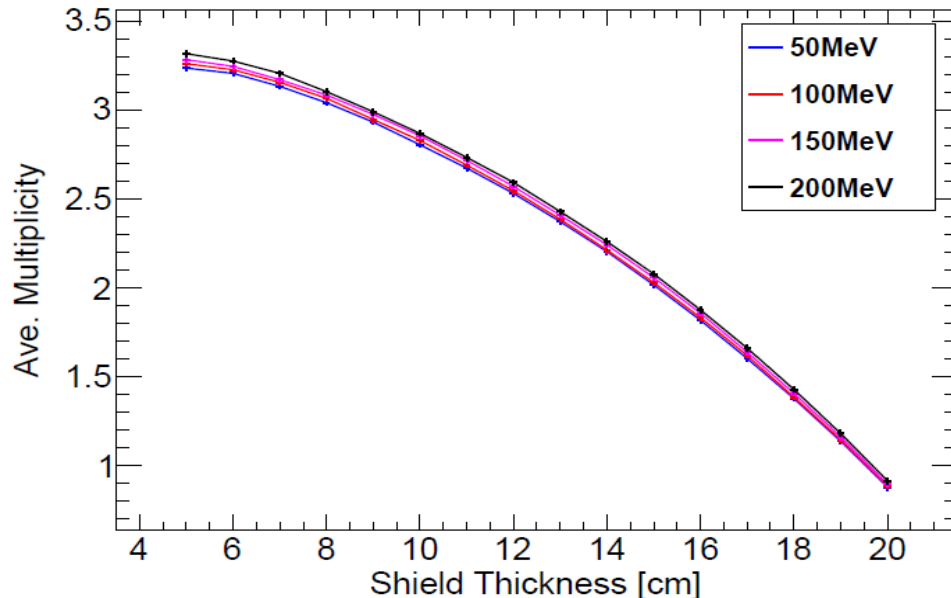

Spectrum of n^0 for scoring at $Z = 14.0$ cm

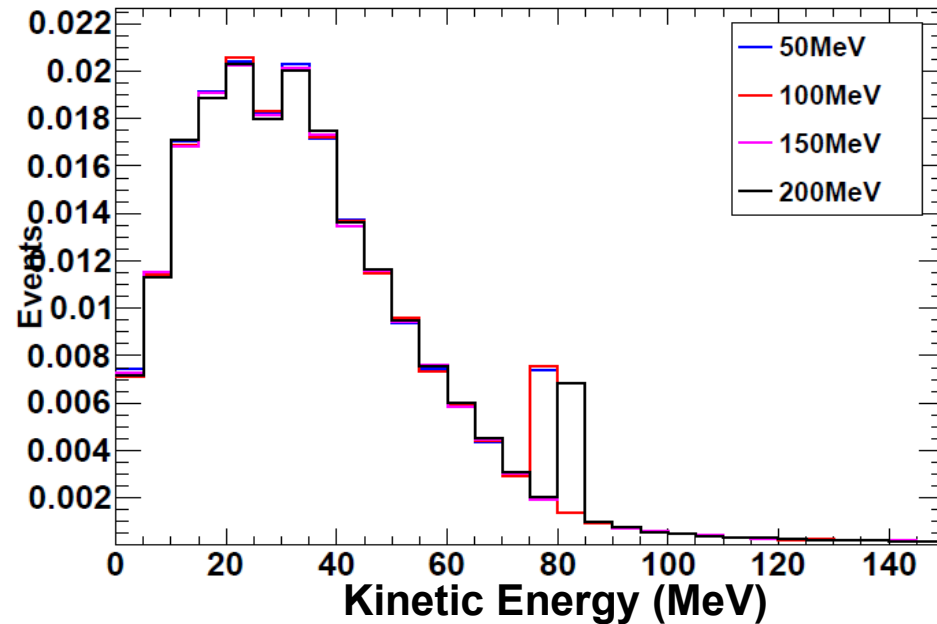

- Incident neutrons with kinetic energies from 50 to 200 MeV get multiplied by a factor of ~ 2.3 for lead thickness of 14cm
 - The kinetic energy spectrum of those neutrons has a slight variation with the incident neutron kinetic energy
 - Outgoing neutrons have a significant amount of kinetic energy (10 – 70 MeV)
- \Rightarrow Add a Boron-loaded (5%) polyethylene shield

FDIRC shield: BRN implementation

- Steel-lead-steel sandwich (2.5-10-2.5 cm)
- Boron-loaded (5%) polyethylene (10 cm)

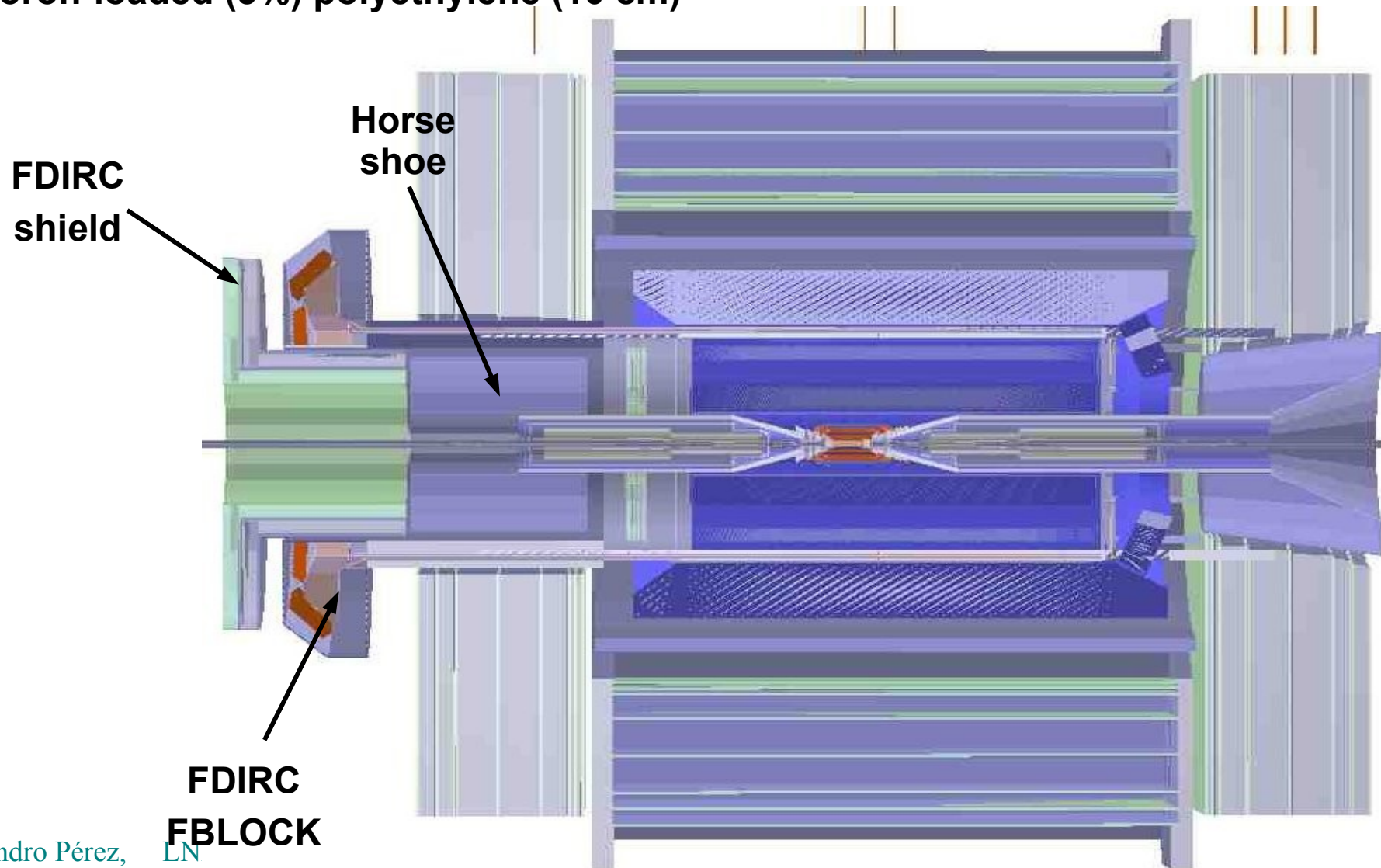

FDIRC shield: BRN implementation

- Steel-lead-steel sandwich (2.5-10-2.5 cm)
- Boron-loaded (5%) polyethylene (10 cm)

Steel-Lead-Steel

Boron-loaded
polyethylene

FDIRC FEE boards
have been
implemented by
R. Cenci

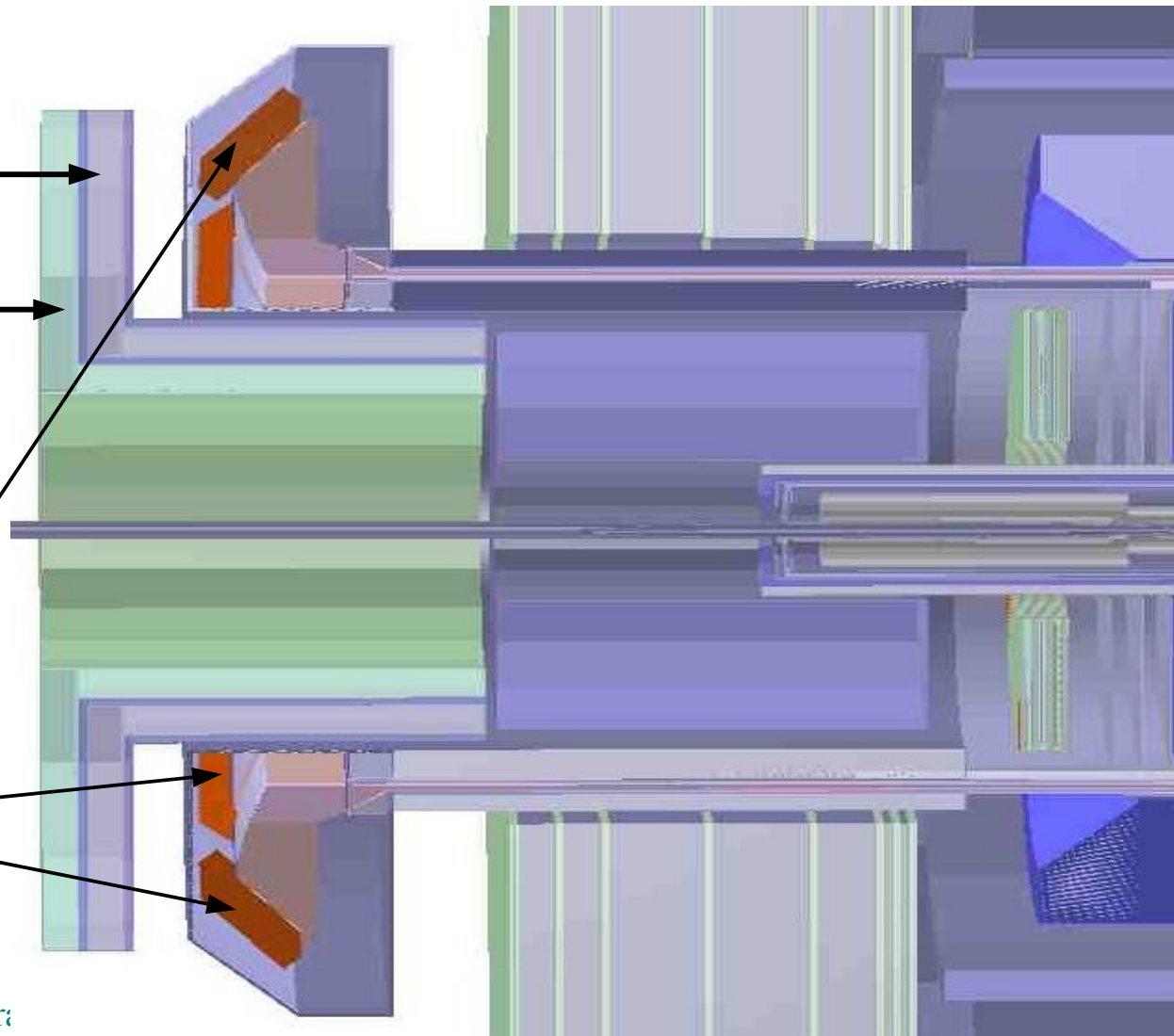

Summary

- **Beam-gas HER of the same order as Touschek LER**
- **The main machine background contribution on the FDIRC is due to Radhabhabha, mainly from tracks hitting the quartz bar in the FBLOCK region**
- **Main flux of particles on FBLOCK are photons with energy lower than 200MeV**

- **Shields:**
 - Lead thickness of 14cm can reduce the background by a factor of ~10. Shield BRN implementation: steel-lead-steel (2.5-10-2.5 cm) sandwich
 - **Neutrons:**
 - Neutron multiplication by a factor ~2.2 for lead shield thickness of 14cm
 - Will add a Boron-loaded polyethylene shield (10 cm)

- **FEE:**
 - FEE boards implemented and instrumented by Riccardo
 - Ready to study the doses and neutron fluxes

- **FullSim code will freeze in 2 weeks from now.**
- **FullSim production is expected to start in 3 weeks from now.**

Backup

FDIRC implementation inside BRN (I)

- Previously:
 - Only a standalone model of FDIRC (Doug Roberts)
 - In Bruno:
 - Only a model of FDIRC geometry
 - No Cherenkov (optical) photons activated
 - No instrumentation

Doug Standalone model of FDIRC

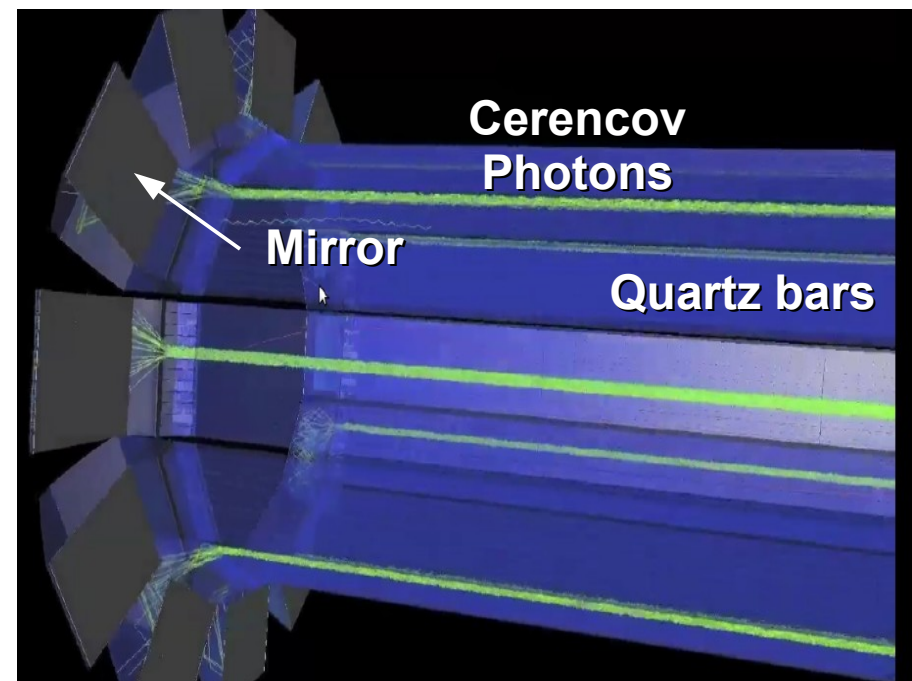
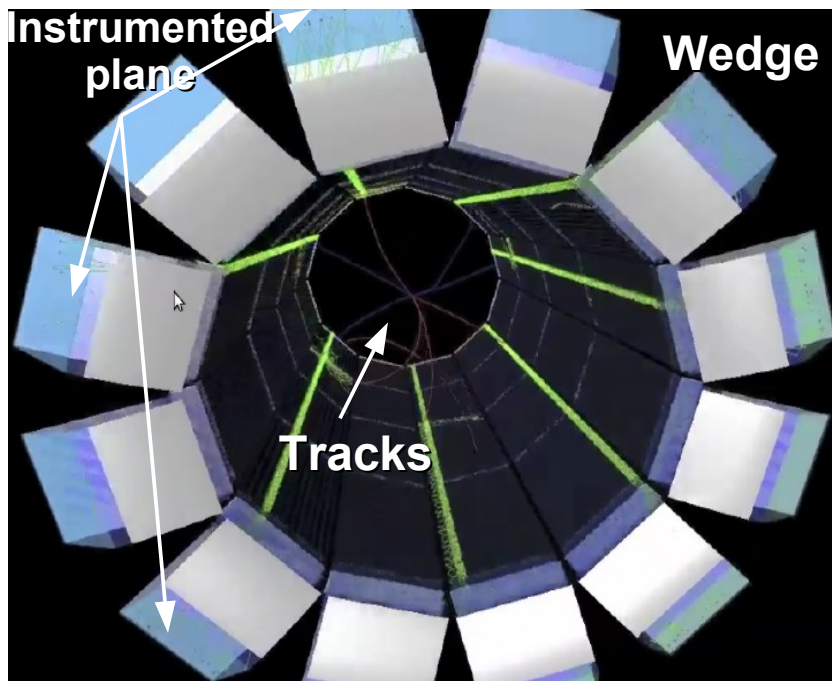

FDIRC implementation inside BRN (II)

But now:

- Doug and Andrea worked hard to insert standalone model inside Bruno
- All the required features are in place:
 - Cherenkov photons activated
 - Photo-camera: the whole photo-camera plane is instrumented. Quantum efficiency already taken into account

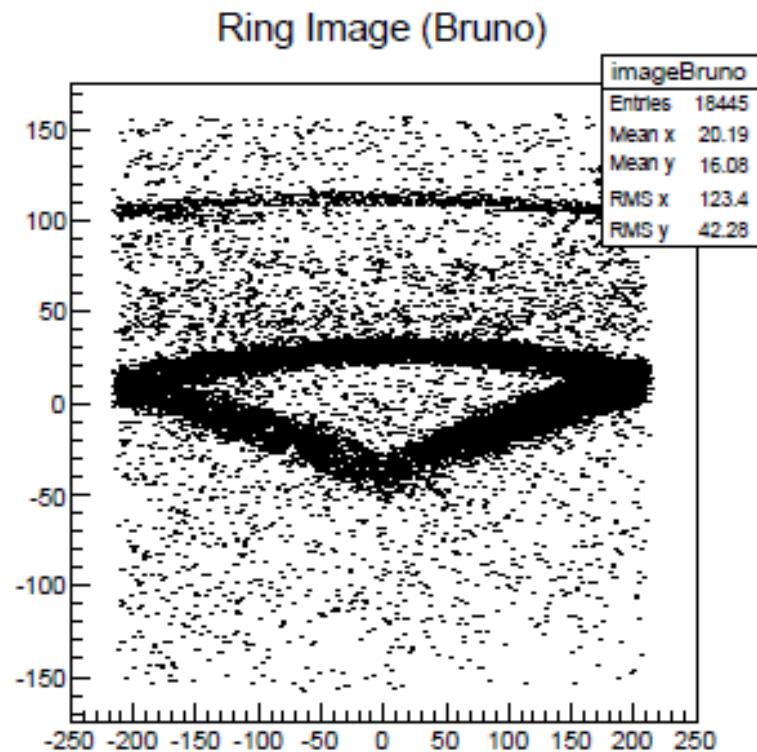
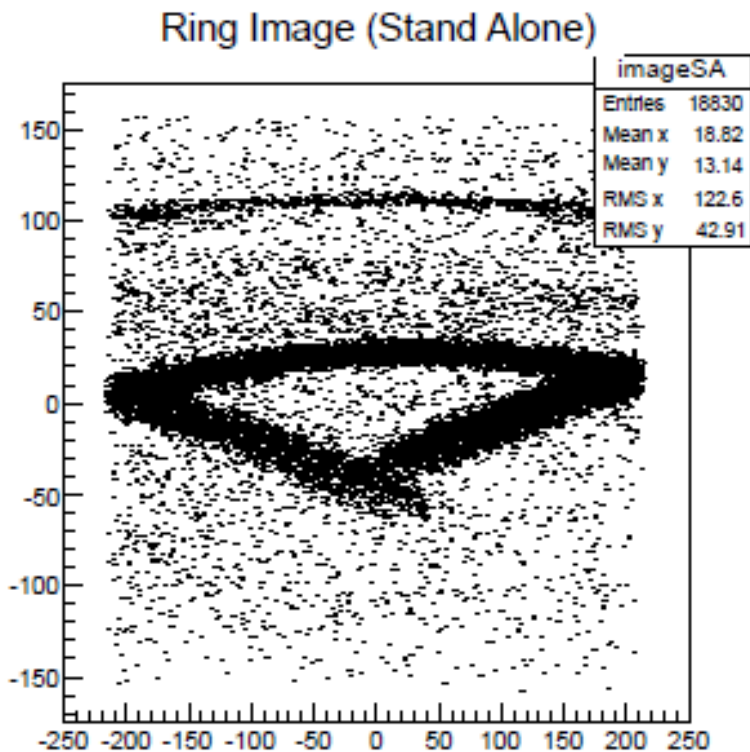

New FF model: Cryostat and Magnets

Zoom around IP

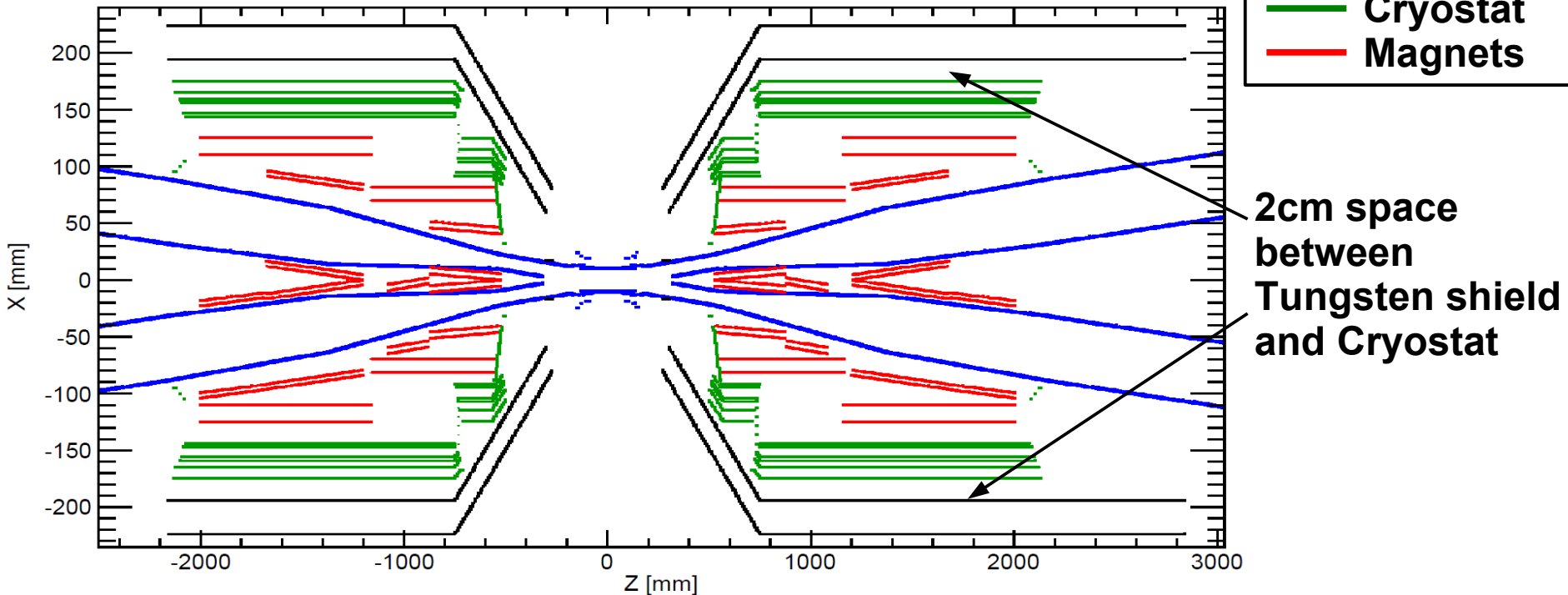

- Space free between cryostat and shield will likely be used for SVT cabling and piping
- Space free between shield and DCH likely used as mechanical clearance
- No much room to increase Tungsten shield. Only possibility is to reduce DCH internal radius

New FF model: Magnetic model (I)

- **Previously:**
 - detector solenoidal field turned off in final focus magnetic model
- **This field is important for an accurate model of two-photon (pairs) backgrounds on SVT. Less important for Rad-Bhaha and Touschek**
- **Implementation:**
 - Magnitud: 1.5 Tesla
 - Direction: $Z > 0$ (0.0,0.0,1.0)
 - Volume: field different from zero only inside a cylinder of length 40cm and radius 40cm.

New FF model: Magnetic model (II)

X vs Z plane

Nominal Trajectory

X vs Z plane

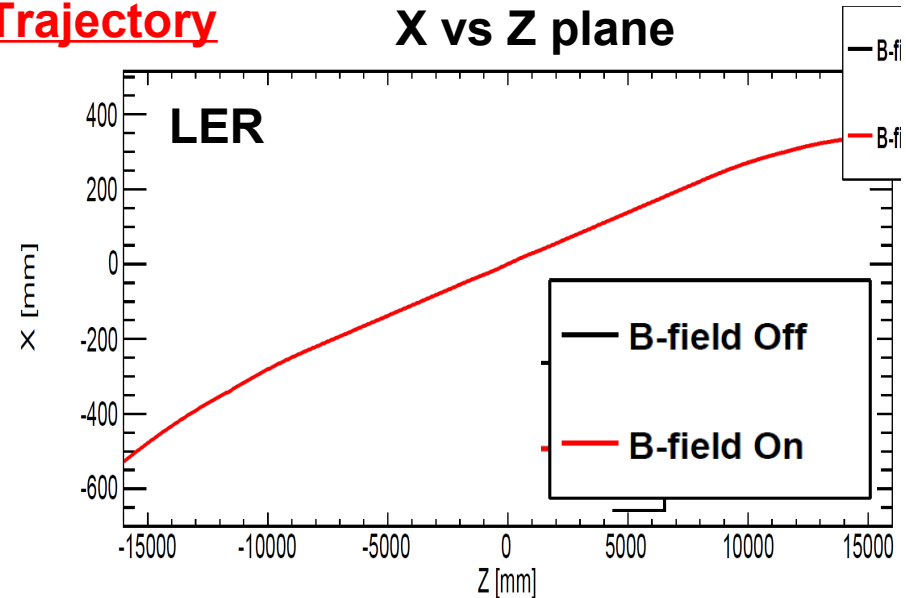
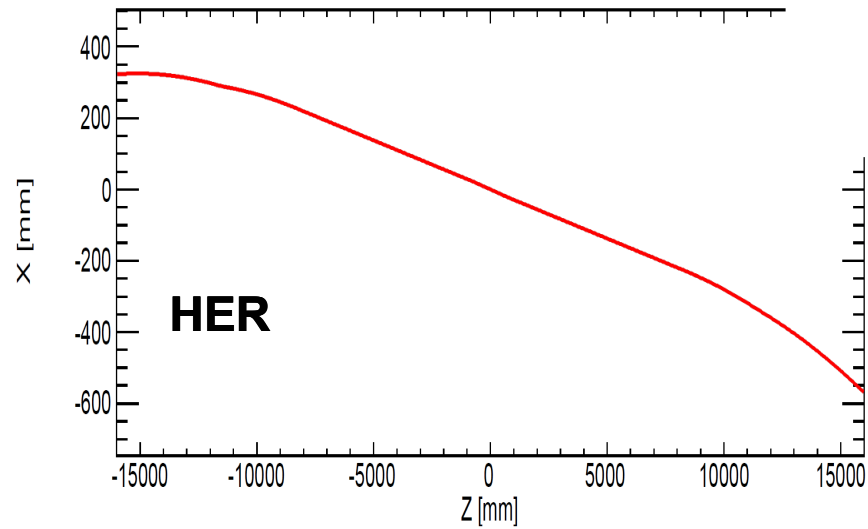

X vs Z (diff w.r.t 0.8cm)

X vs Z (diff w.r.t 0.8cm)

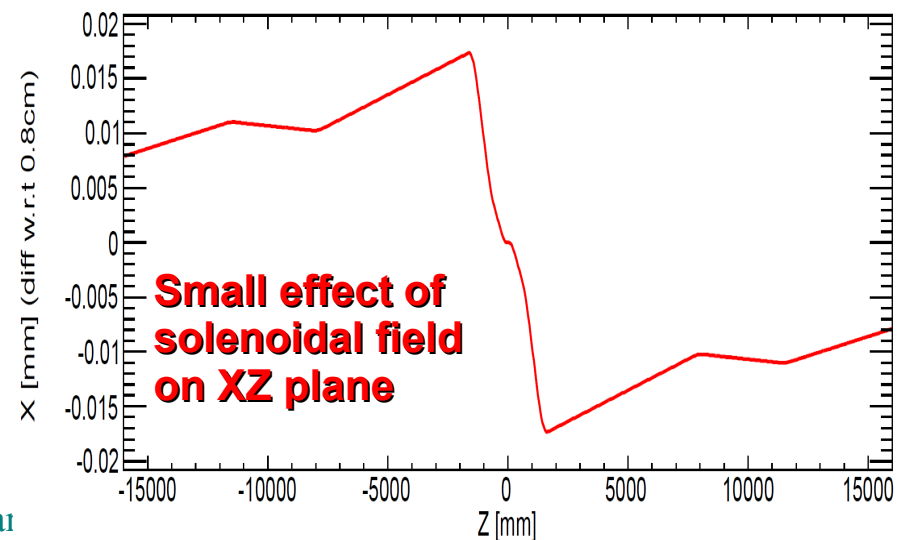
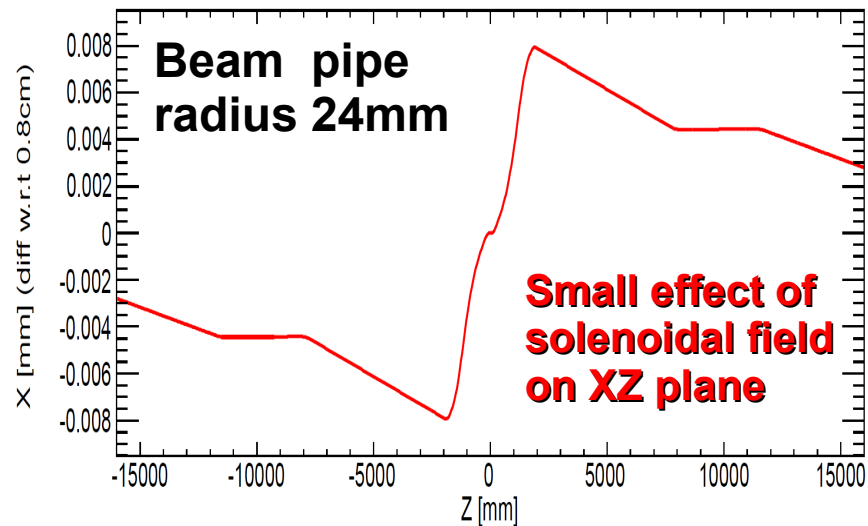

New FF model: Magnetic model (III)

Y vs Z plane

Nominal Trajectory

Y vs Z plane

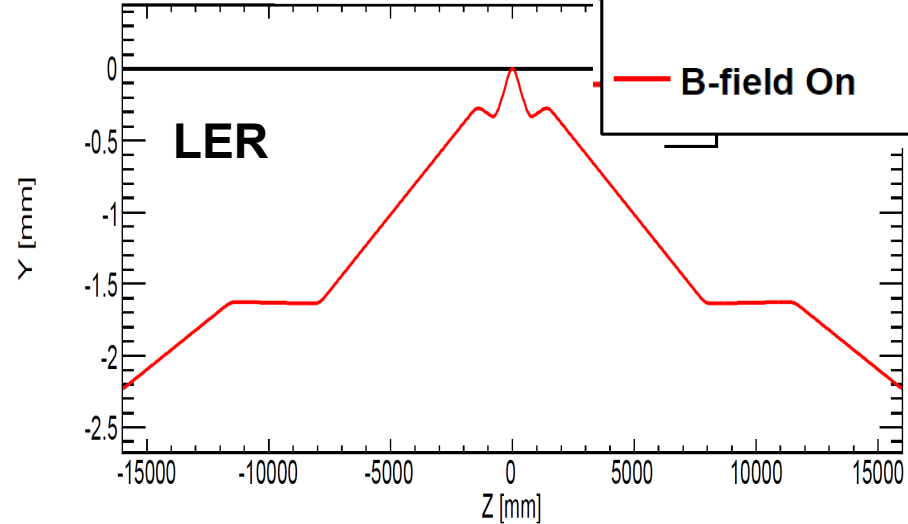
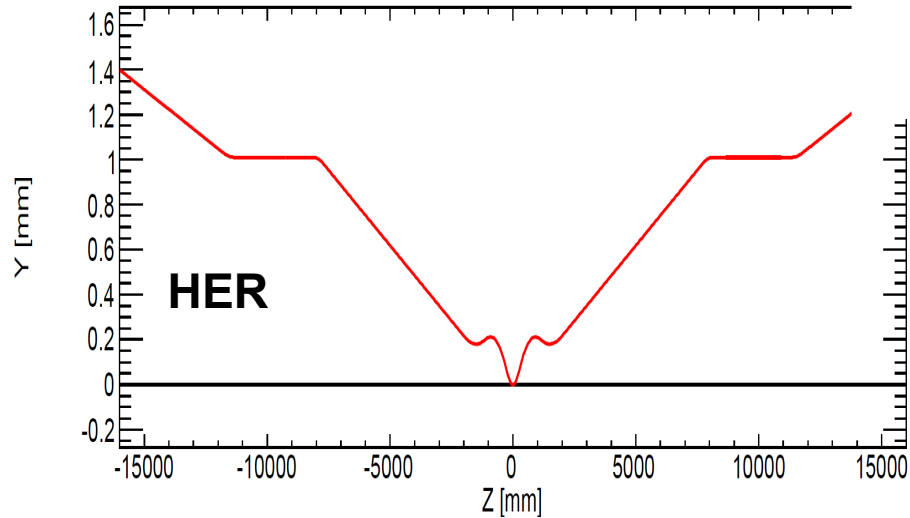
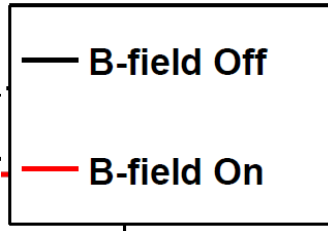

Y vs Z (diff w.r.t 0.8cm)

Y vs Z (diff w.r.t 0.8cm)

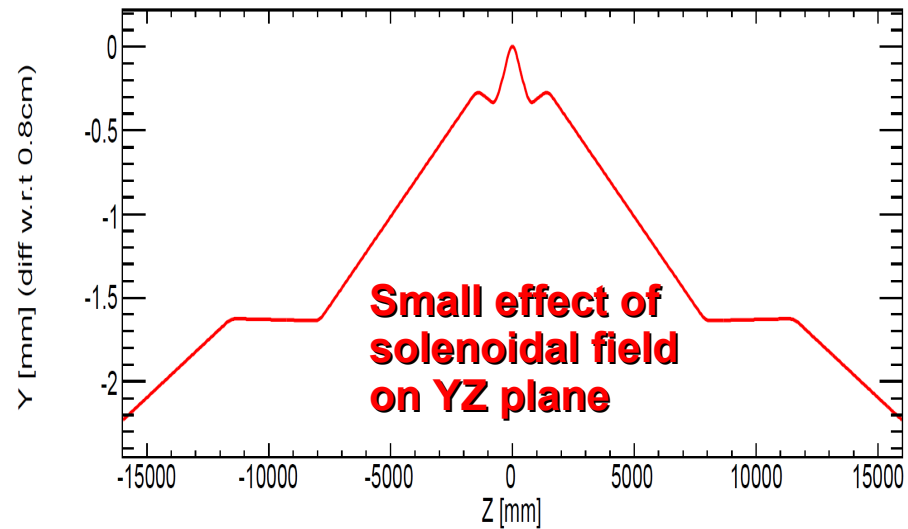
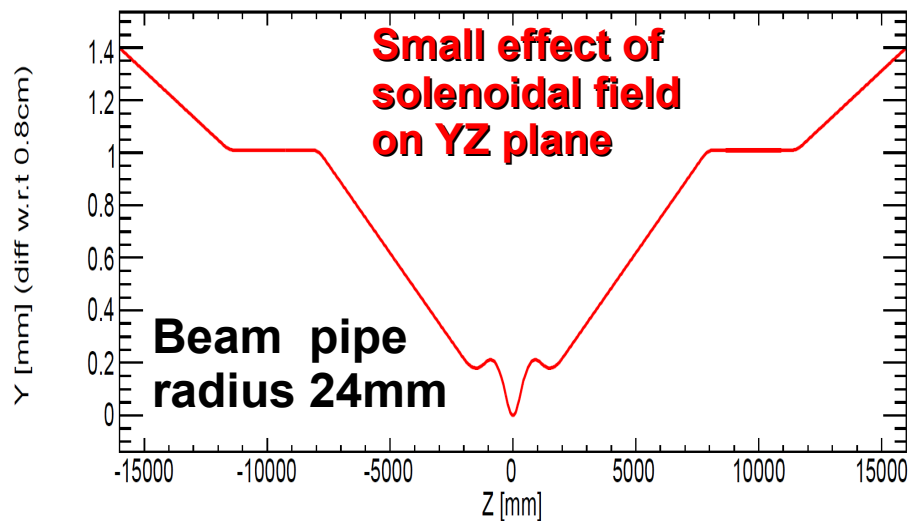

New FF model: Cryostat and Magnets (I)

Filippo Bosi
Drawings

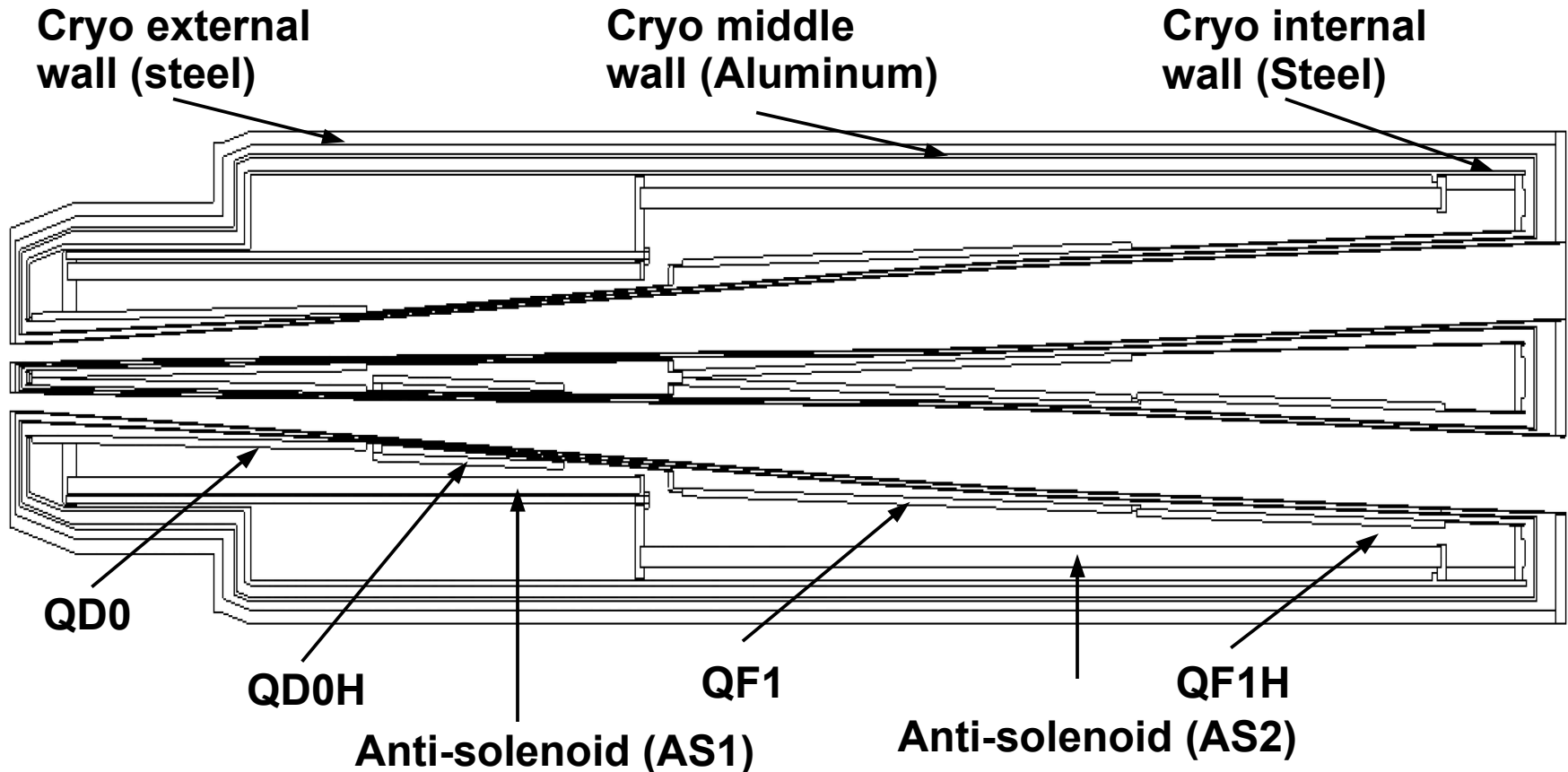

- All magnetic elements are made of the same material (QD0_mixture):
 - Density: 7.57 gr/cm^3
 - Composition: Niobium (0.106), Titanium (0.119), Cooper (0.347) and Iron (0.428)

New FF model: Cryostat and Magnets (II)

BRN implementation

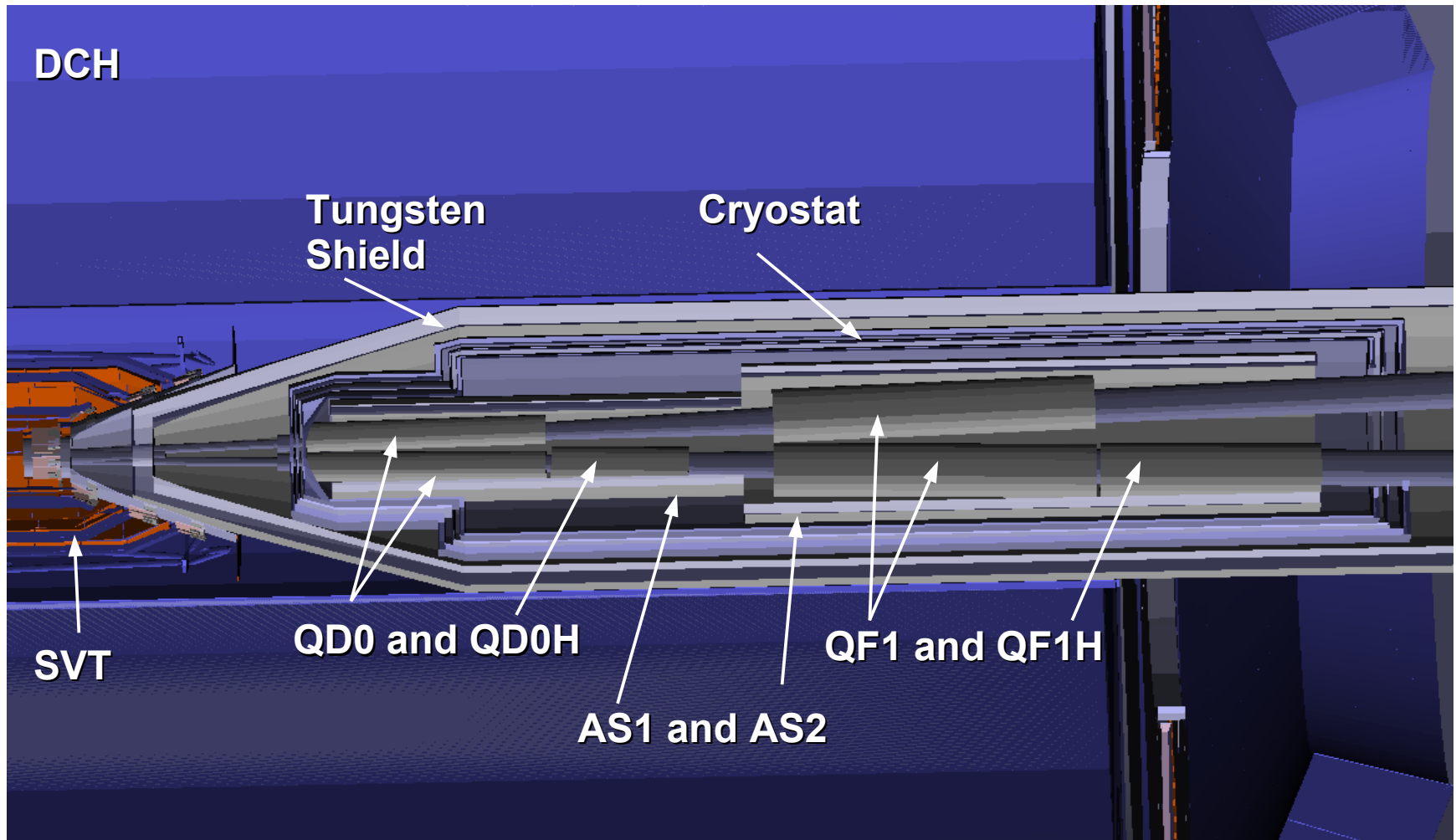

Results

- **Will show the results for one representative FDIRC sector (sector 6) only just to show the format**
- **The full set of plots can be found at the web,**

- Rad-bhabha:

http://www.slac.stanford.edu/~aperez/SuperB/SuperB_Pisa/FDIRC_Bkg_Studies/Plots_RadBhabha_background_FDIRC.pdf

- Pairs:

http://www.slac.stanford.edu/~aperez/SuperB/SuperB_Pisa/FDIRC_Bkg_Studies/Plots_Pairs_background_FDIRC.pdf

- Touschek LER:

http://www.slac.stanford.edu/~aperez/SuperB/SuperB_Pisa/FDIRC_Bkg_Studies/Plots_Touschek_LER_background_FDIRC.pdf

- Touschek HER:

http://www.slac.stanford.edu/~aperez/SuperB/SuperB_Pisa/FDIRC_Bkg_Studies/Plots_Touschek_HER_background_FDIRC.pdf

Results: FDIRC Bkg rates from Rad-Bhabha (I)

Sector 6

Inside Magnet

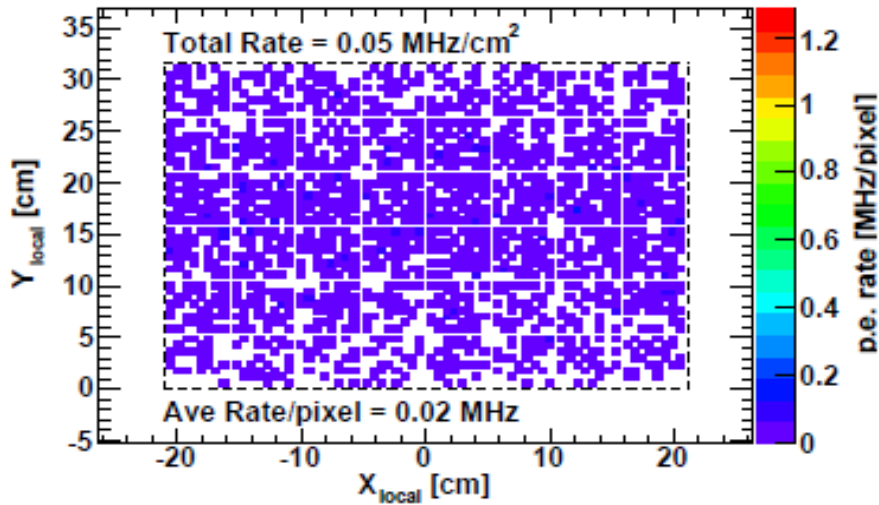

Within Steel

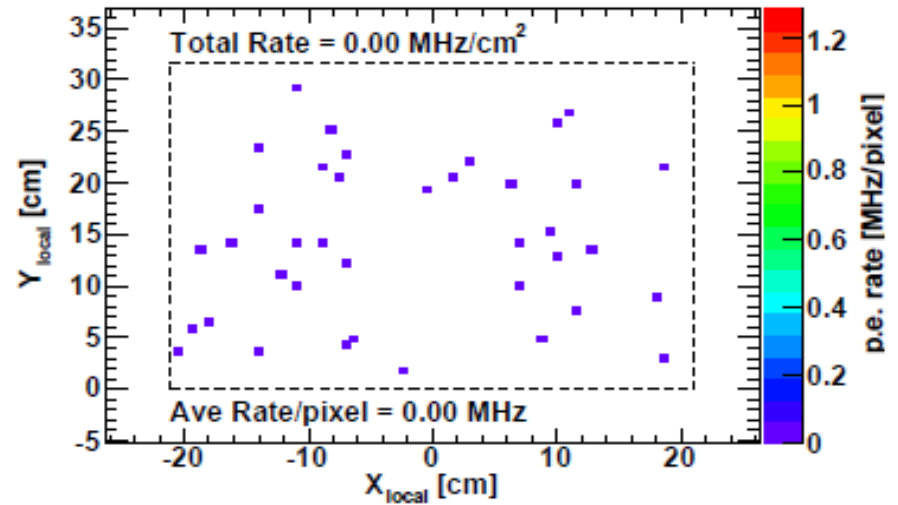

Outside Magnet

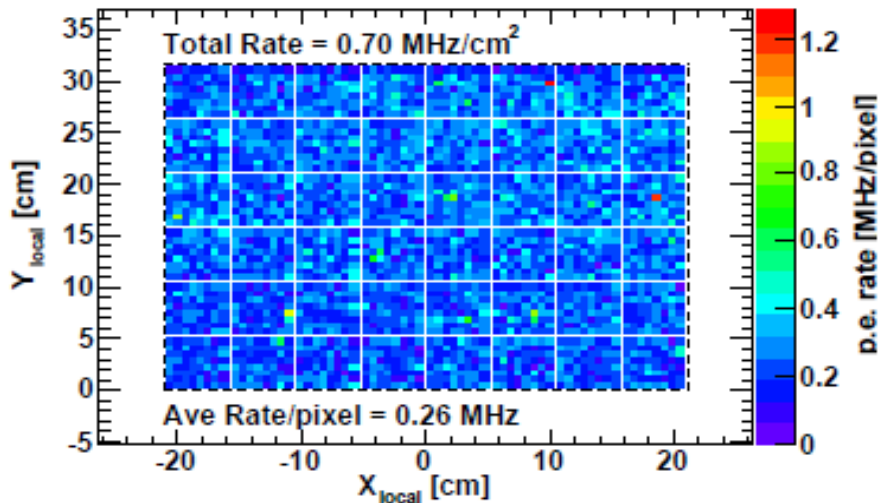

Total Rate

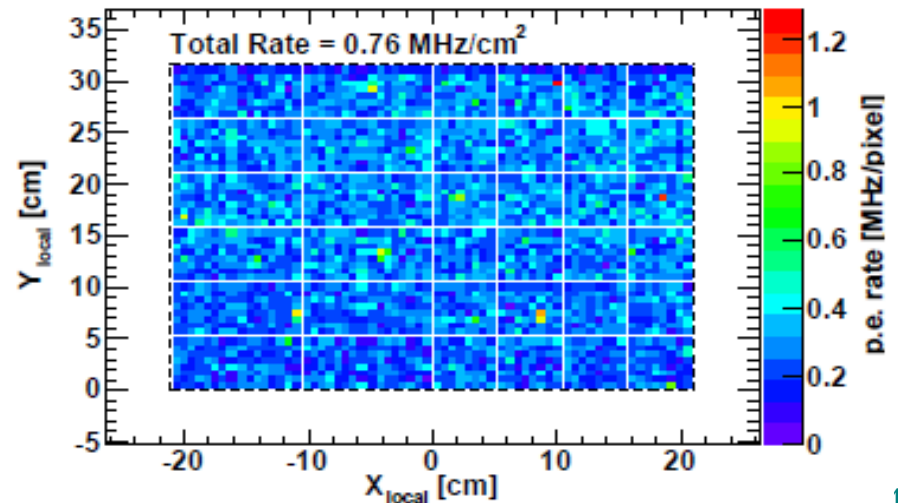

Results: FDIRC Bkg rates from Rad-Bhabha (II)

Total Rate per sector

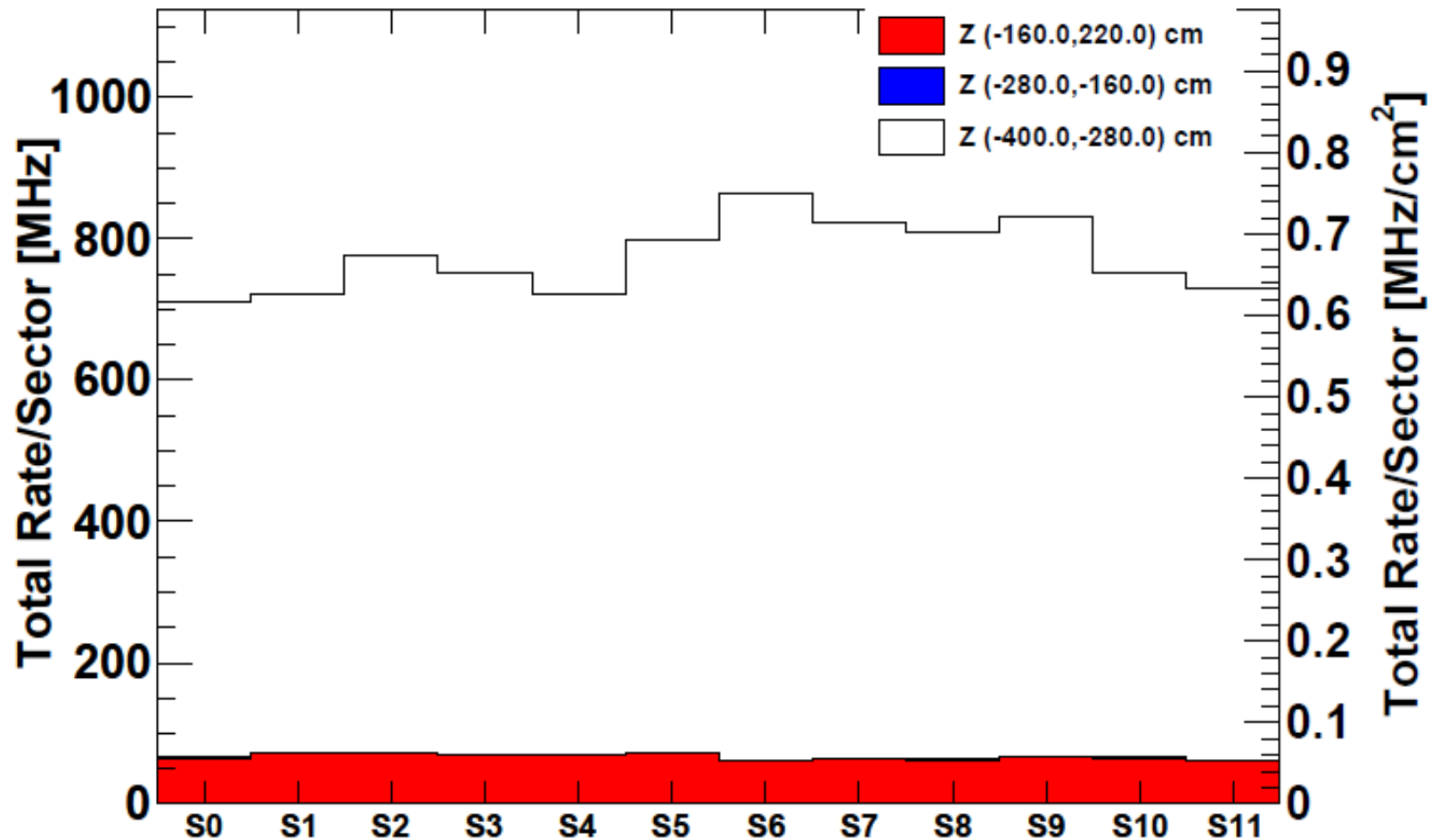

Results: FDIRC Bkg rates from Pairs (I)

Sector 6

Inside Magnet

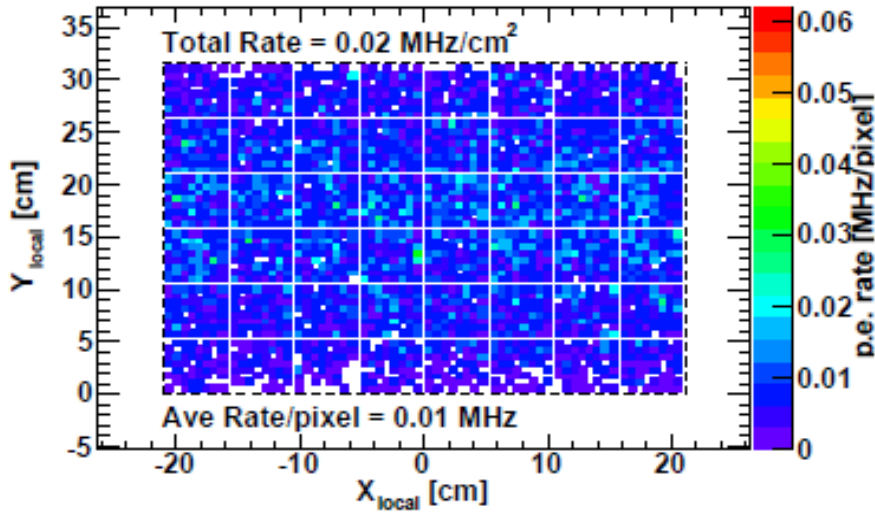

Within Steel

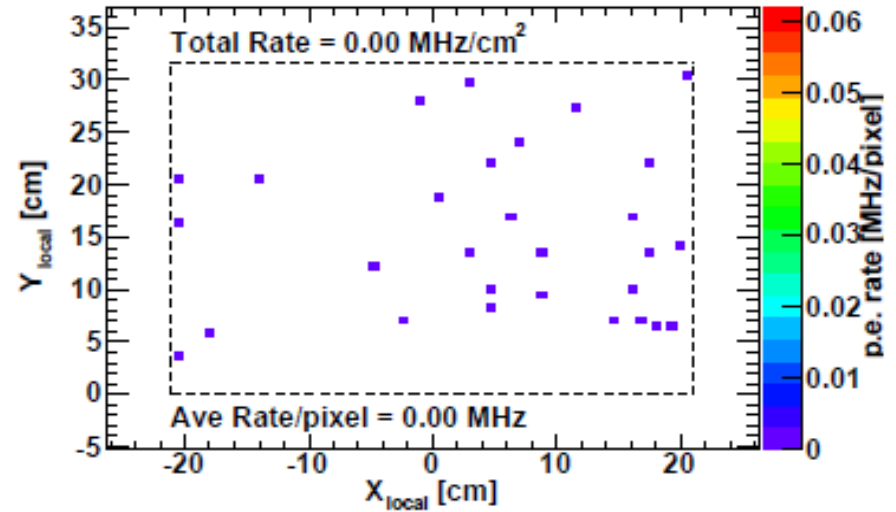

Outside Magnet

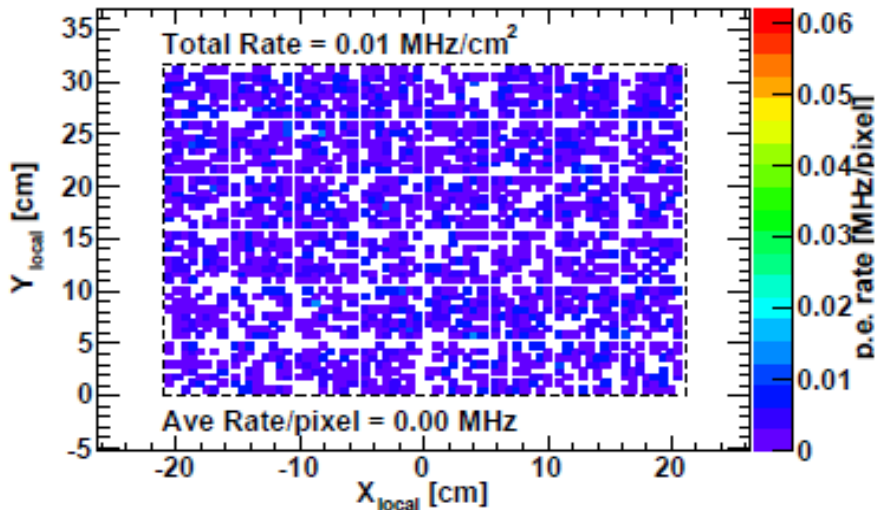

Total Rate

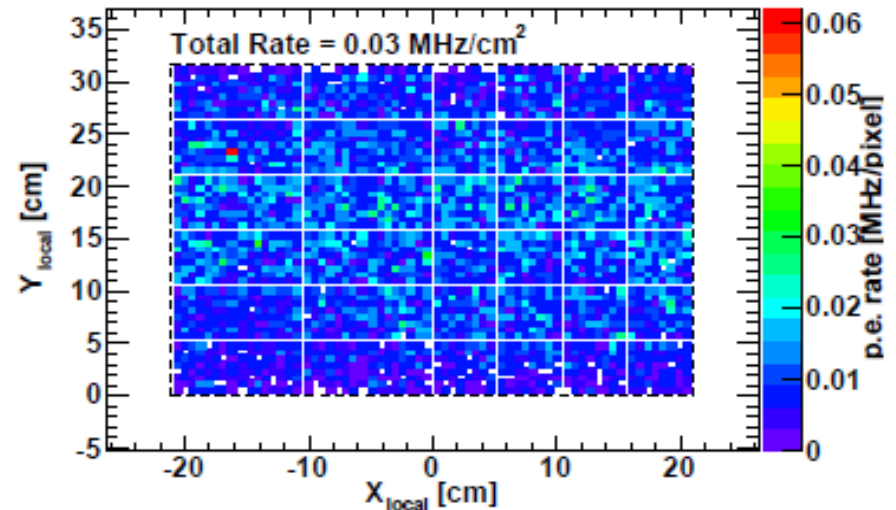

Results: FDIRC Bkg rates from Pairs (II)

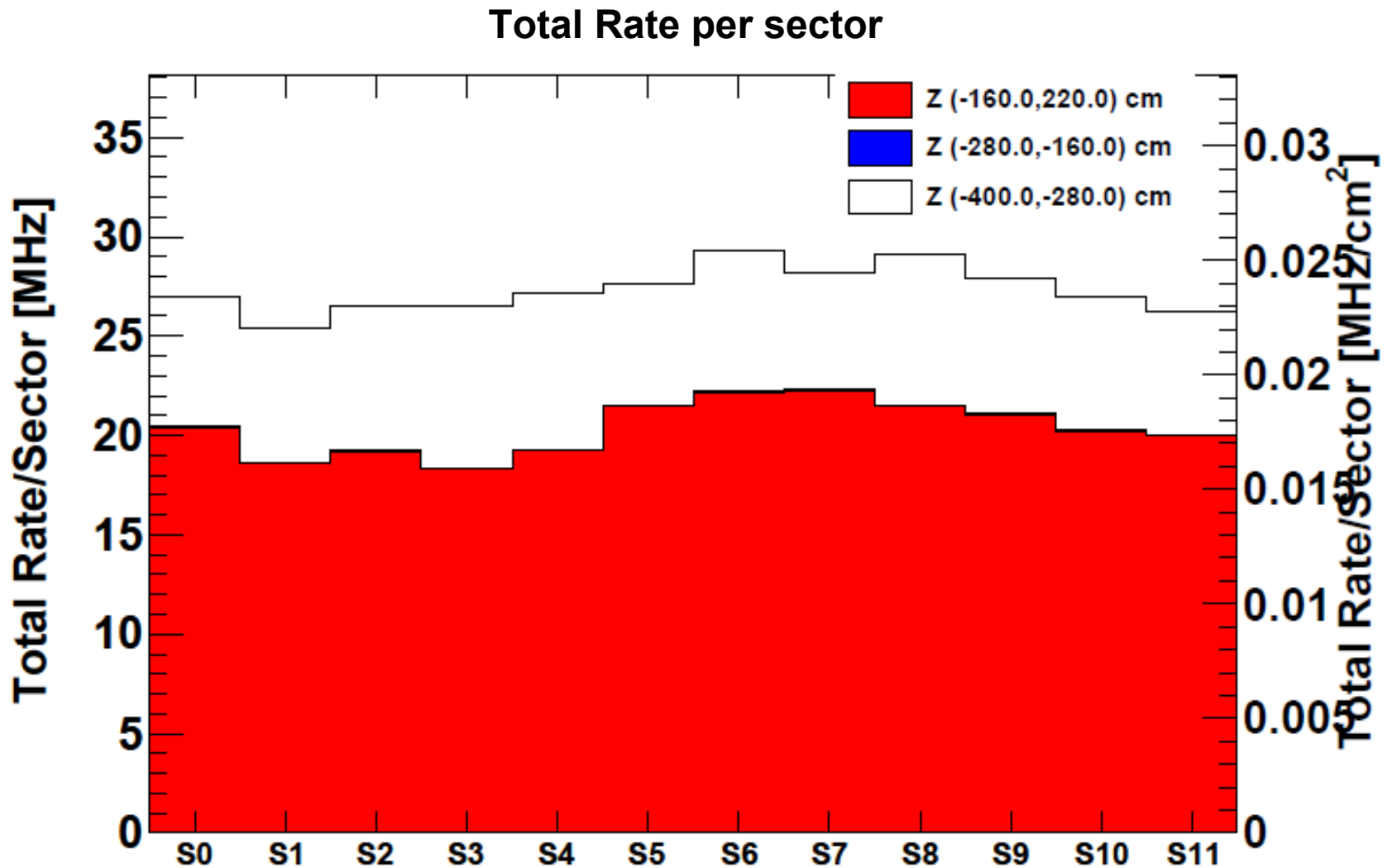

Results: FDIRC Bkg rates from Touschek LER (I)

Sector 6

Inside Magnet

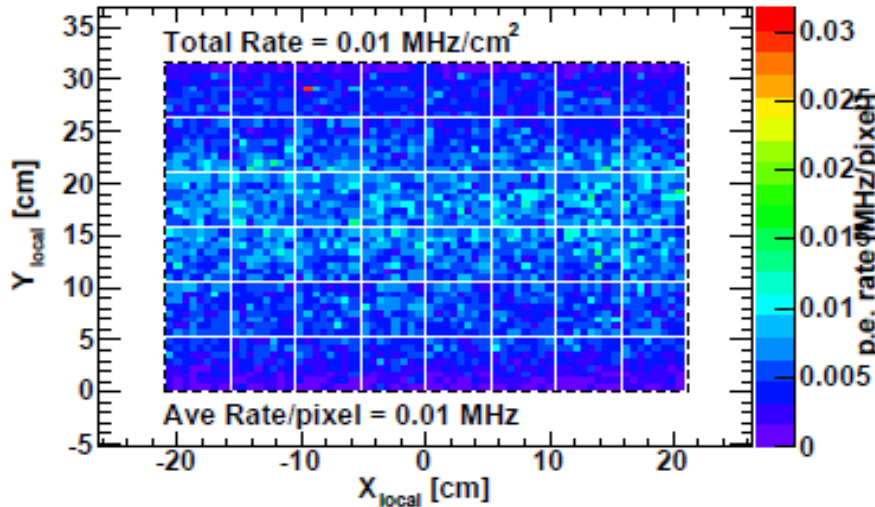

Within Steel

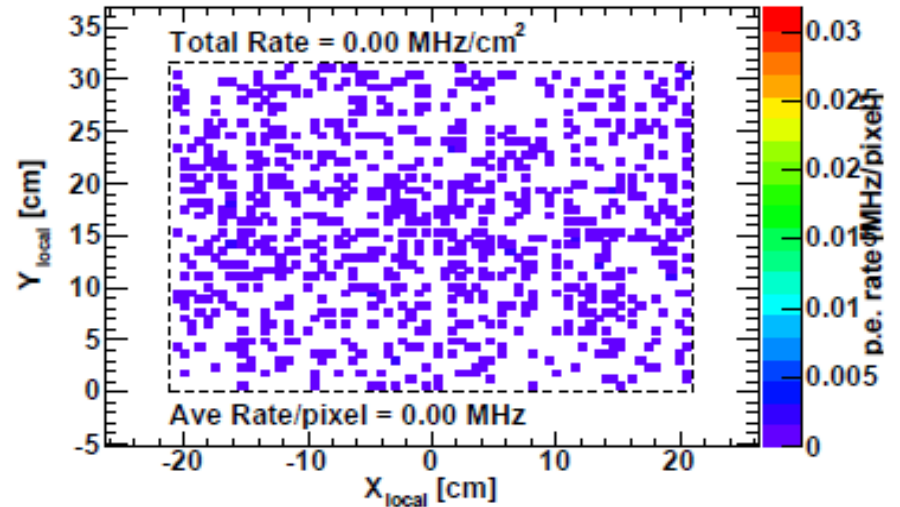

Outside Magnet

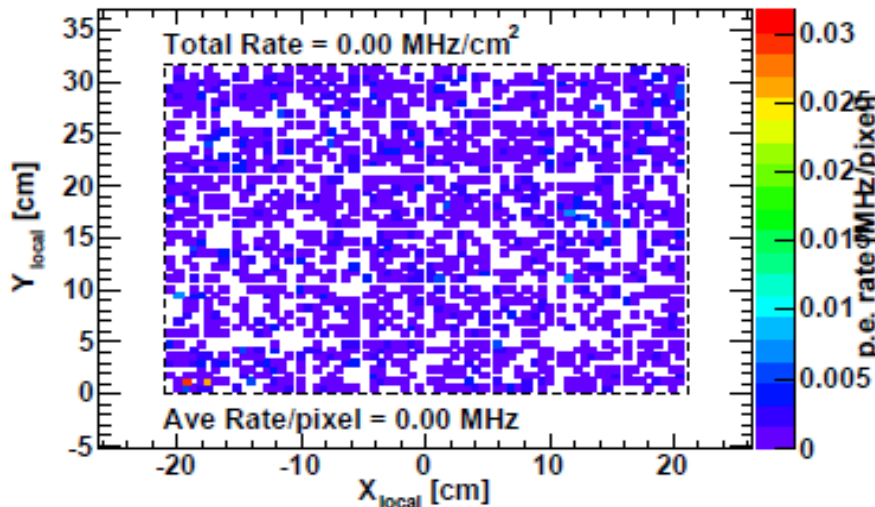

Total Rate

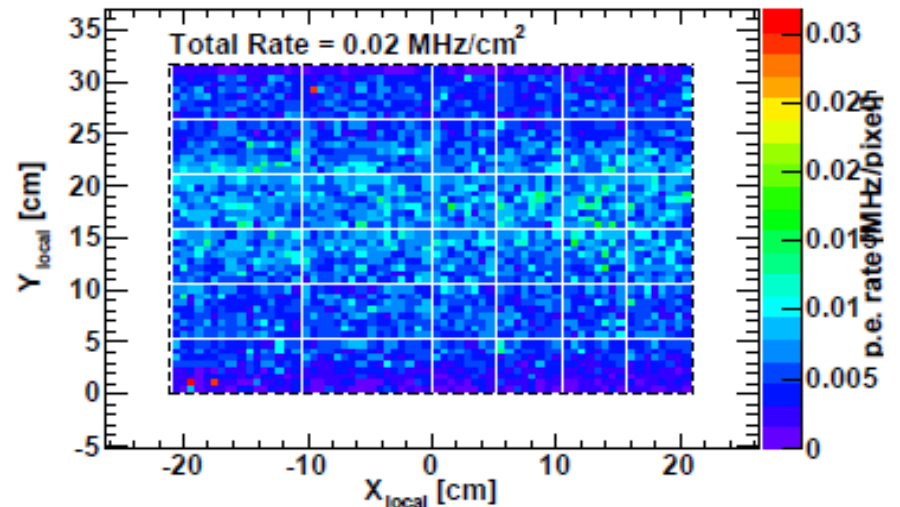

Results: FDIRC Bkg rates from Touschek LER (II)

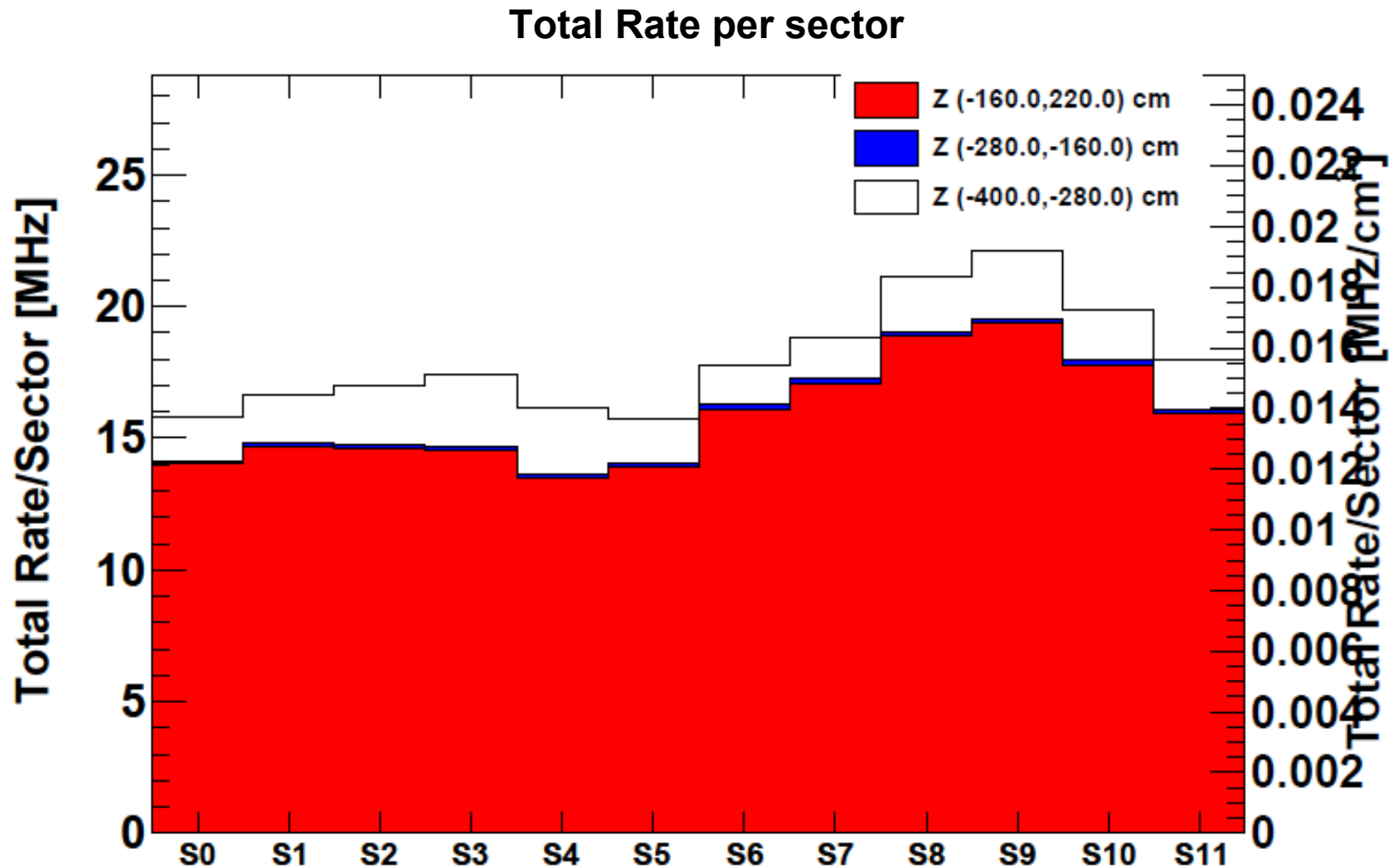

Results: FDIRC Bkg rates from Touschek HER (I)

Sector 6

Inside Magnet

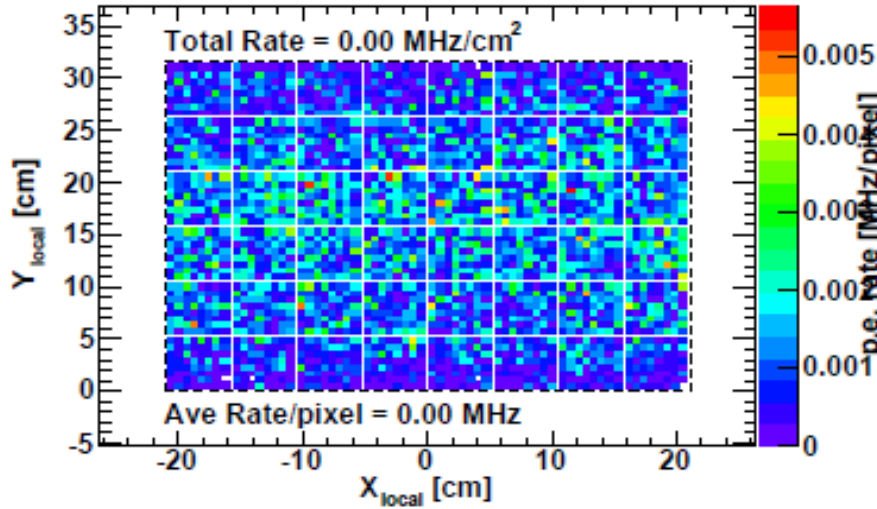

Within Steel

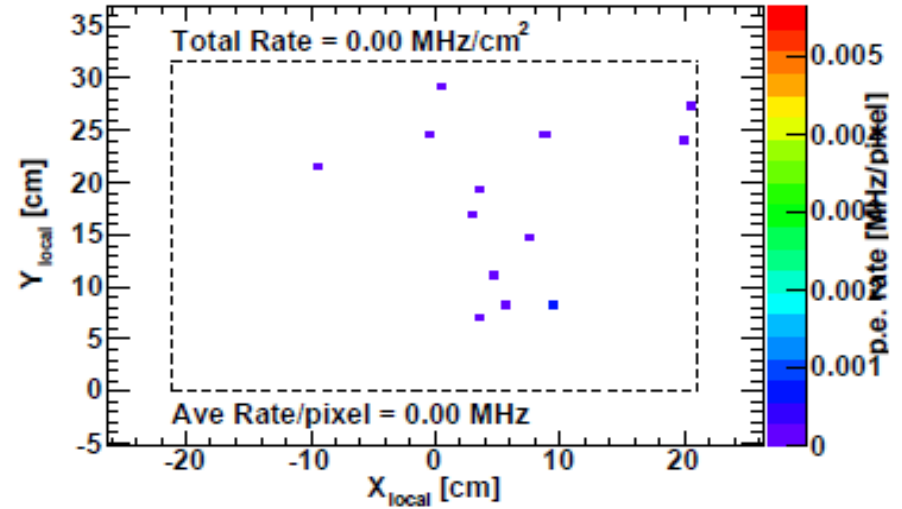

Outside Magnet

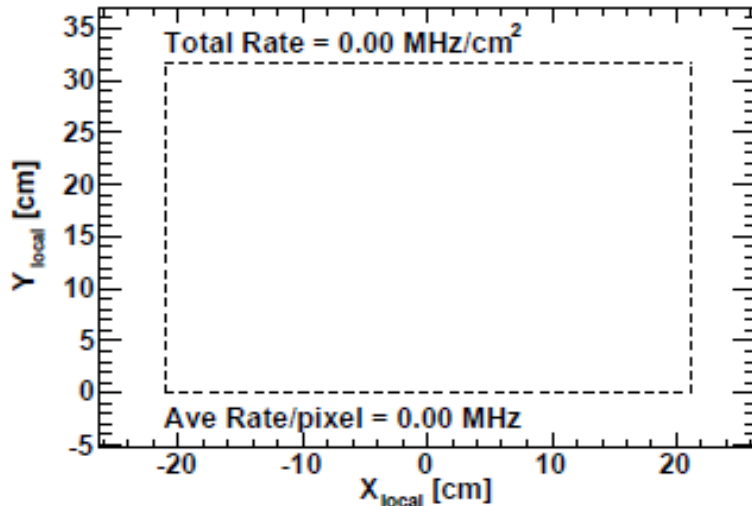

Total Rate

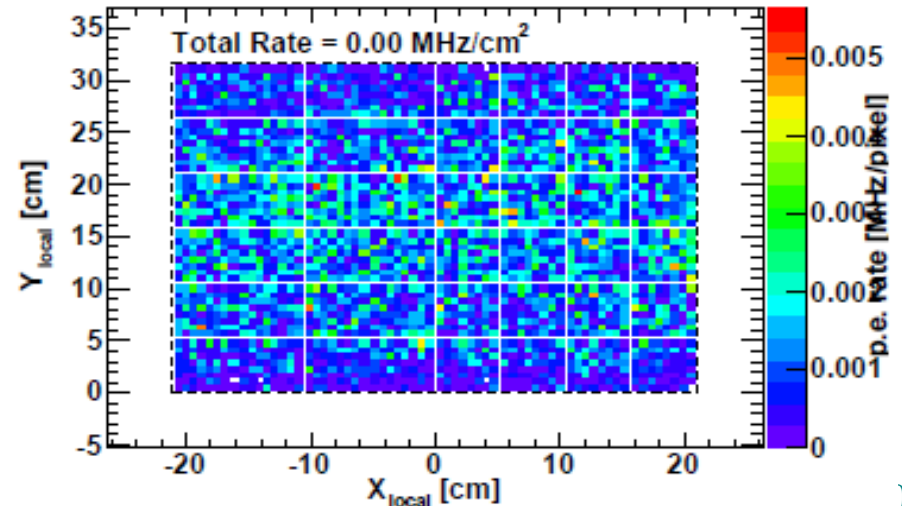

Results: FDIRC Bkg rates from Touschek HER (II)

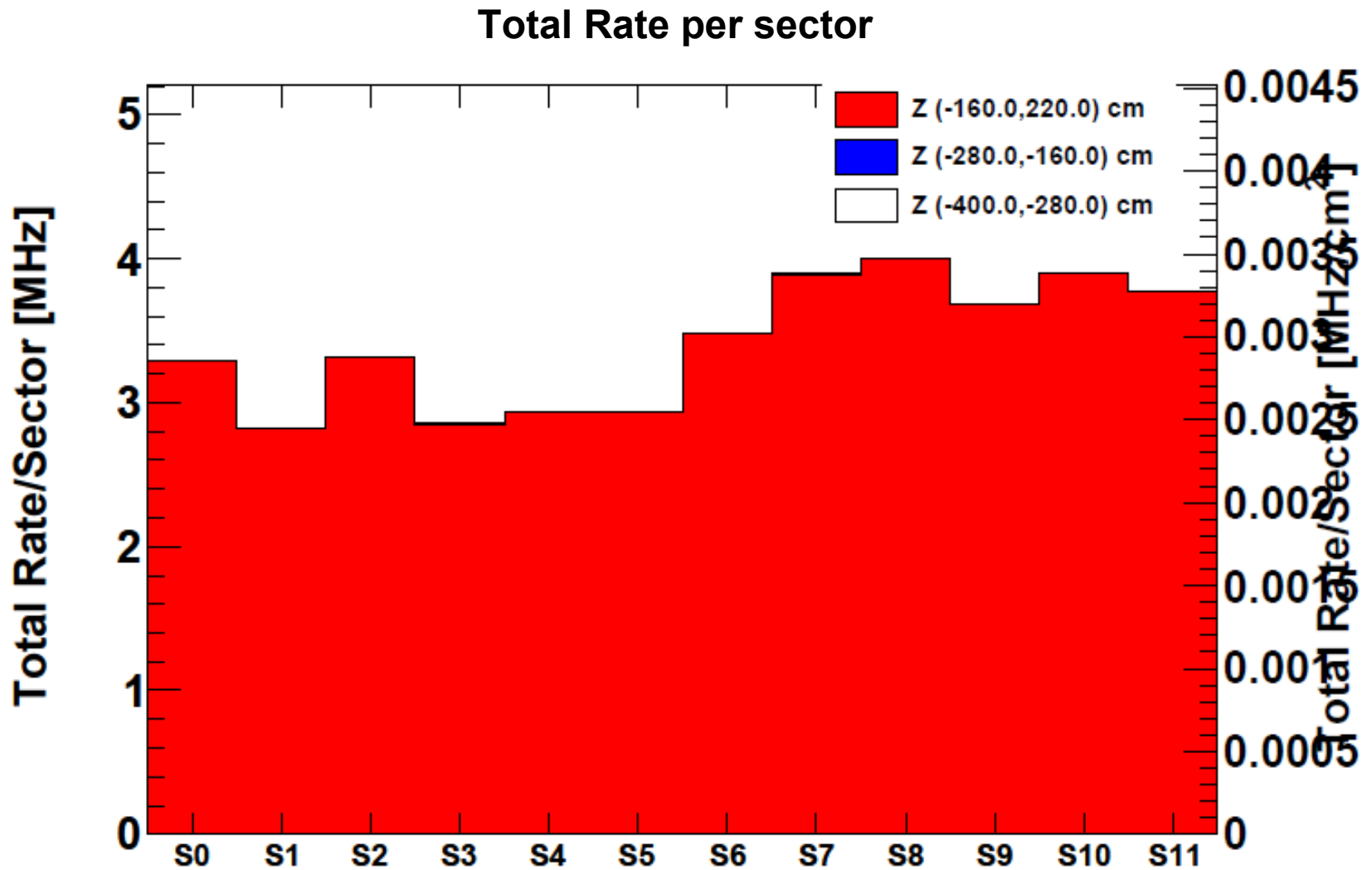

Results: total bkg rates on FDIRC

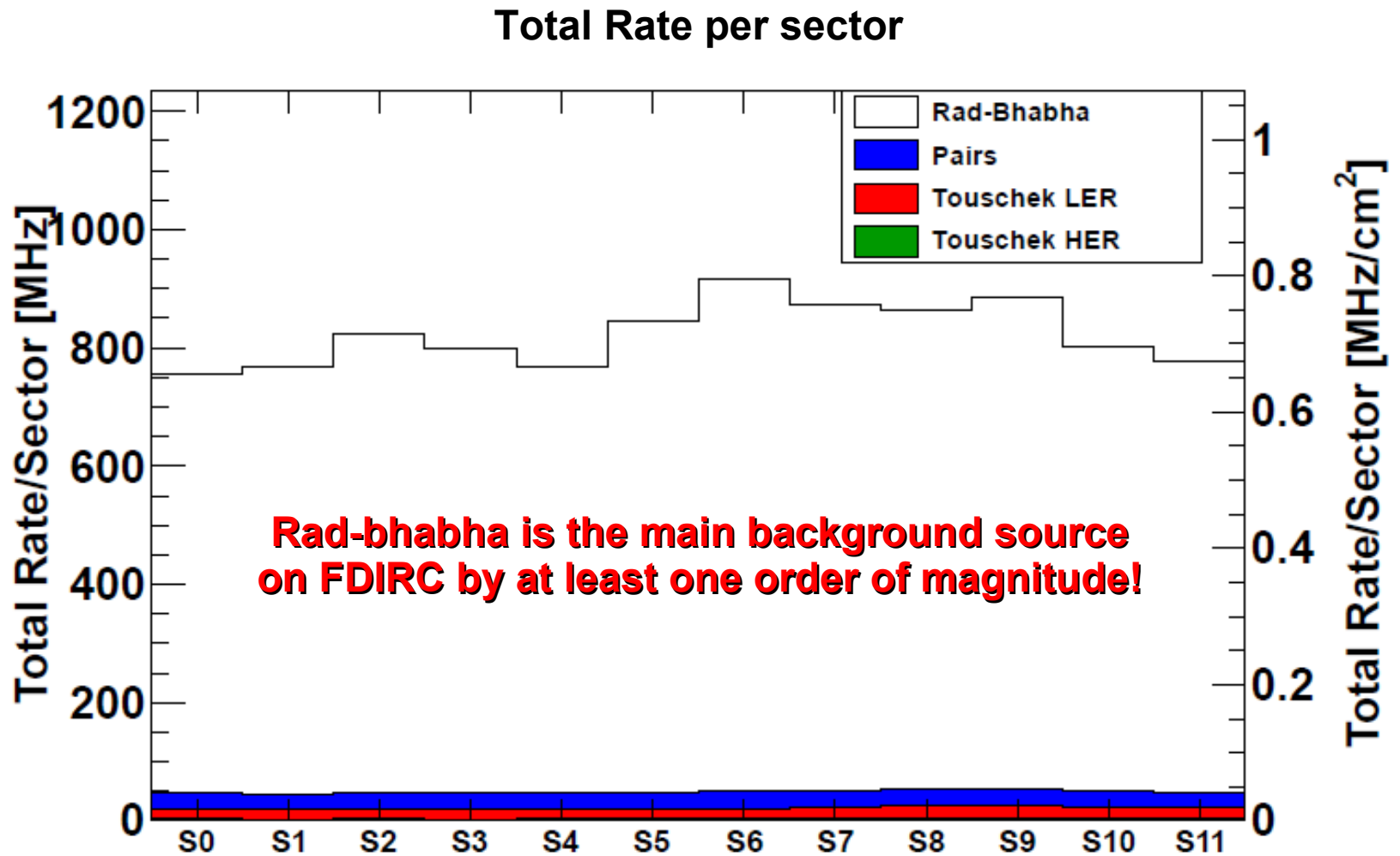

Bwd Horseshoe BRN implementation

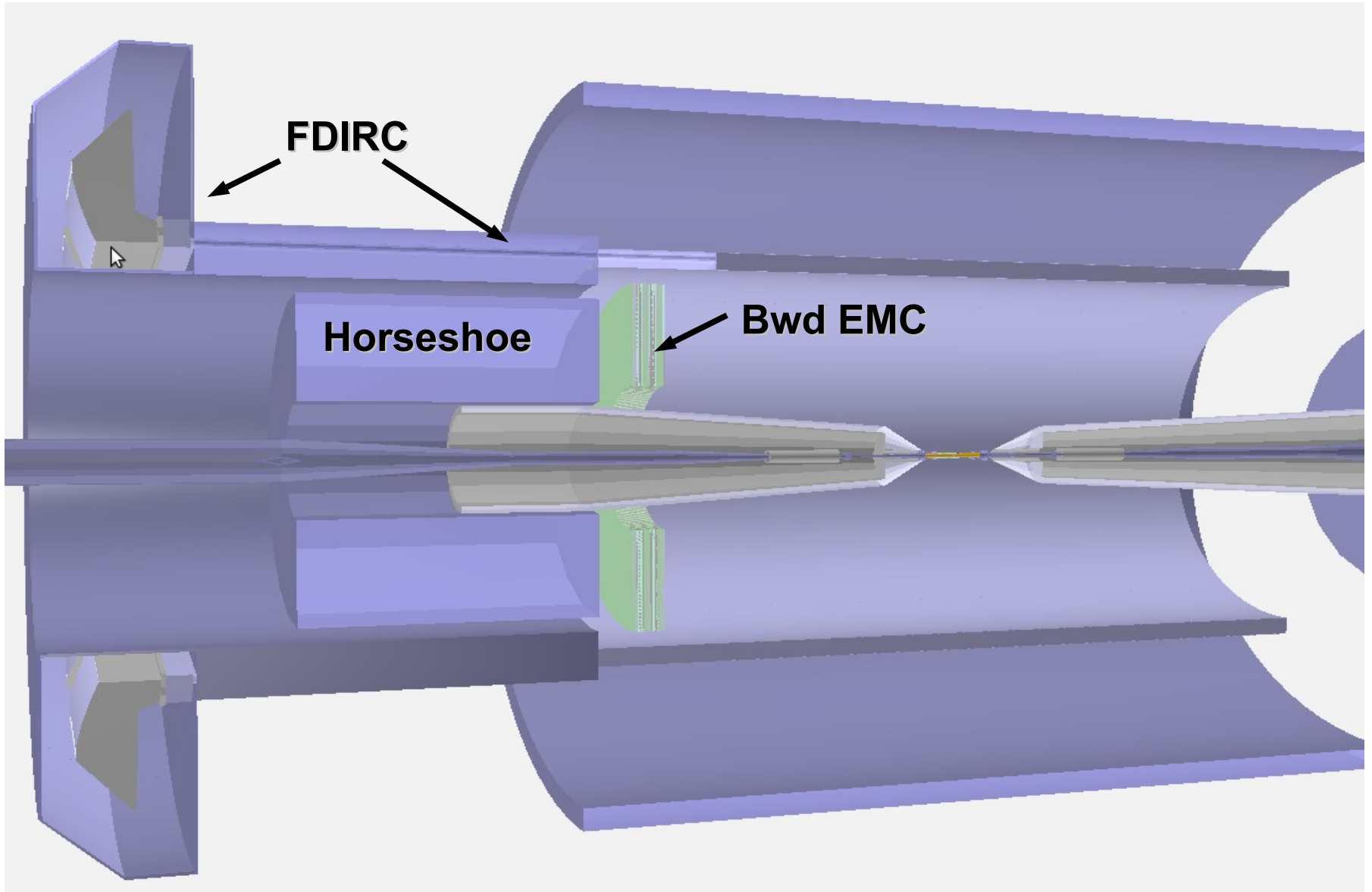

Additional shield under photo-camera

Additional shield at BABAR

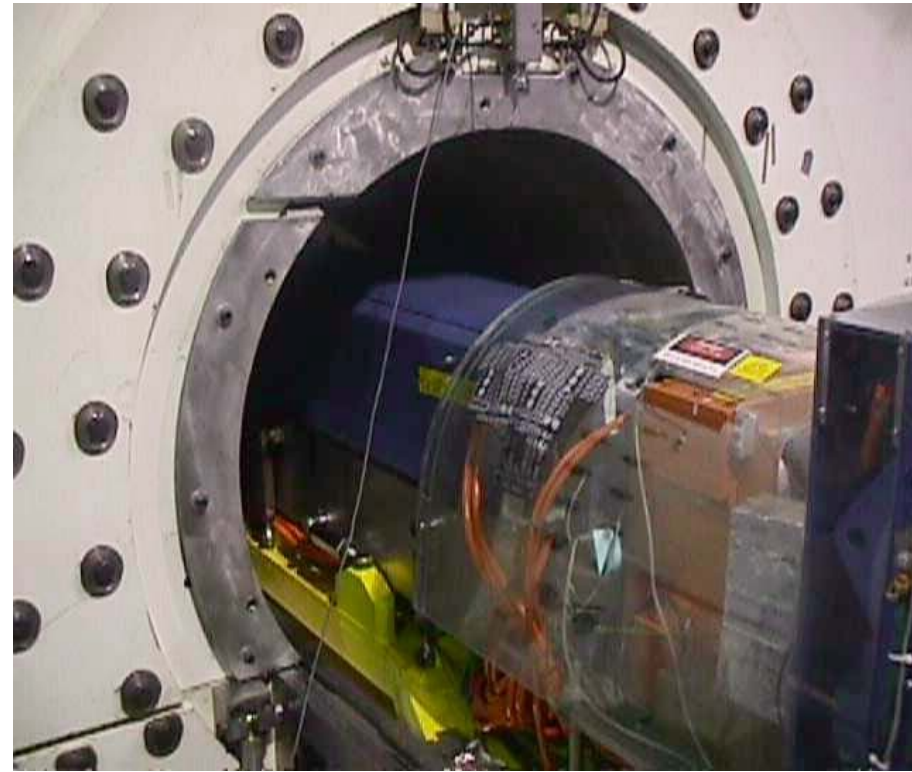
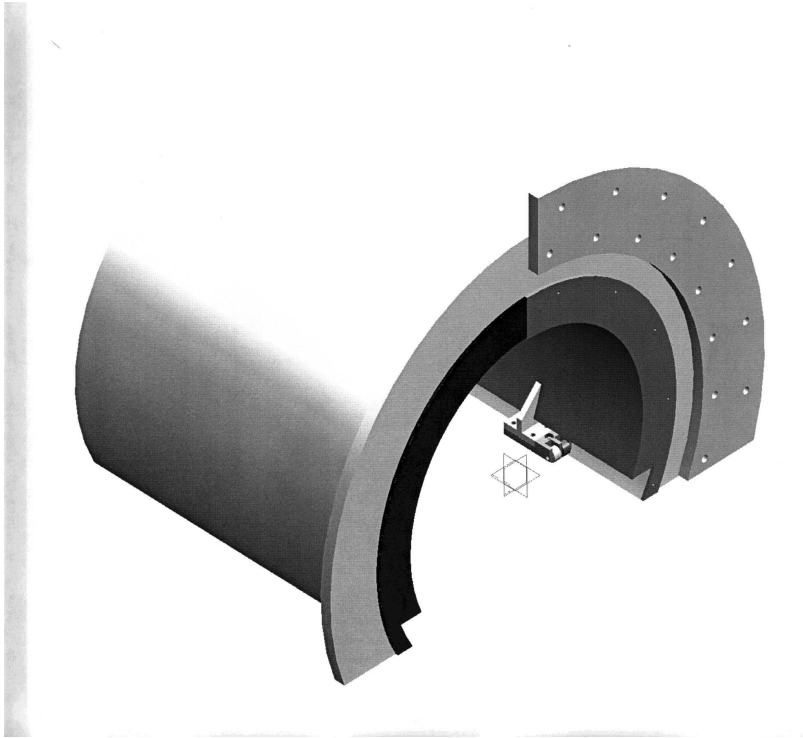

- **Need the characteristics of this shield**
 - Material
 - Dimensions