



# **ITS3 - Mechanics**

## **Activities in Bari**

## WP5 activities

- ➔ Agreement with Corrado for collaboration
  - Starting from existing tools and procedures, we will develop our own ones and share during the WP5 meetings
  - Target specific assemblies
- ➔ First assembly: BBM6-heaters
  - Completion by June-July

# WP5 activities - BBM6

- ➔ Full setup design
- ➔ Heaters electrical and mechanical design and procurement
- ➔ Silicon dicing

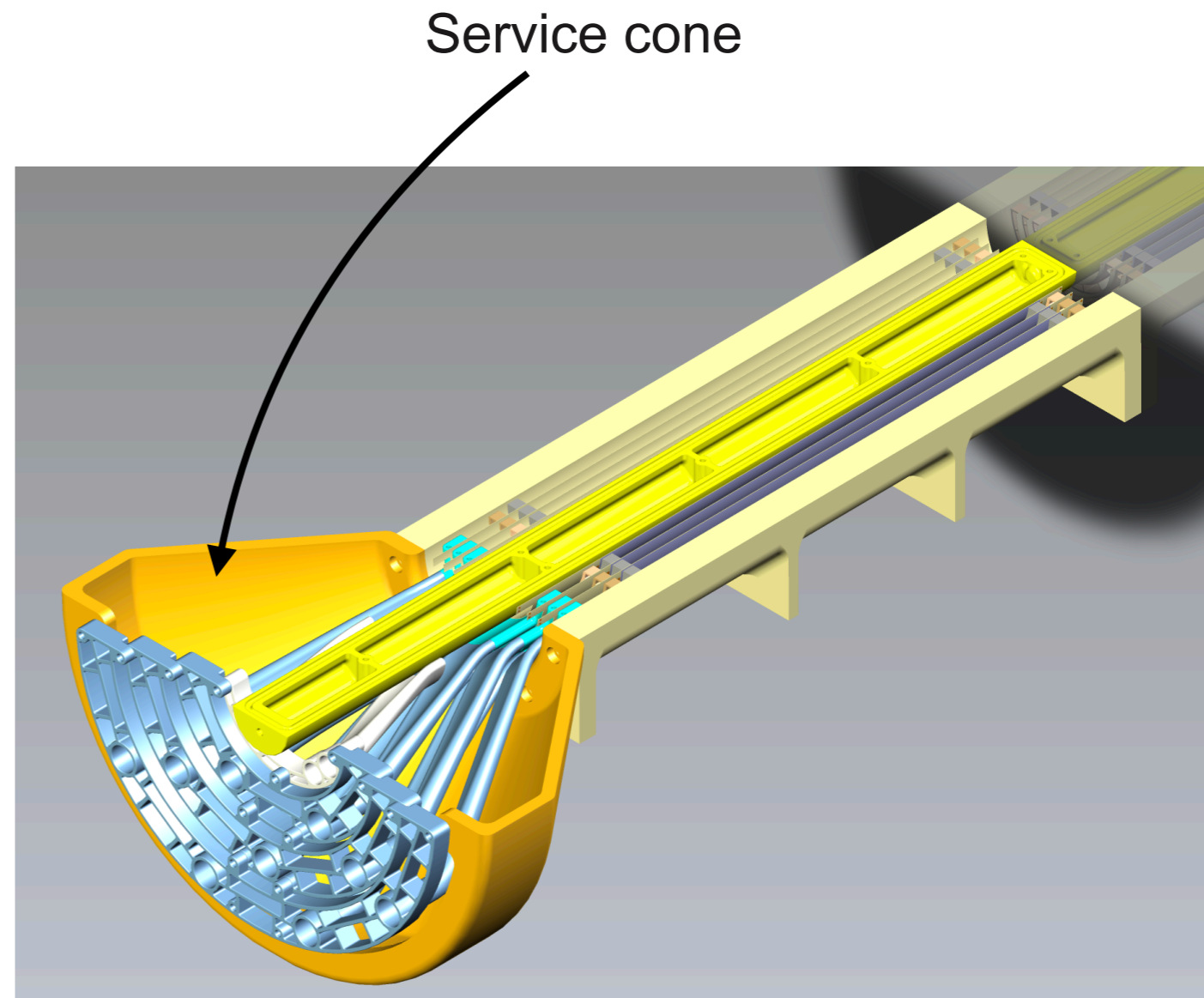

# WP5 activities - BBM6

- ➔ Full setup design
- ➔ Heaters electrical and mechanical design and procurement
- ➔ Silicon dicing

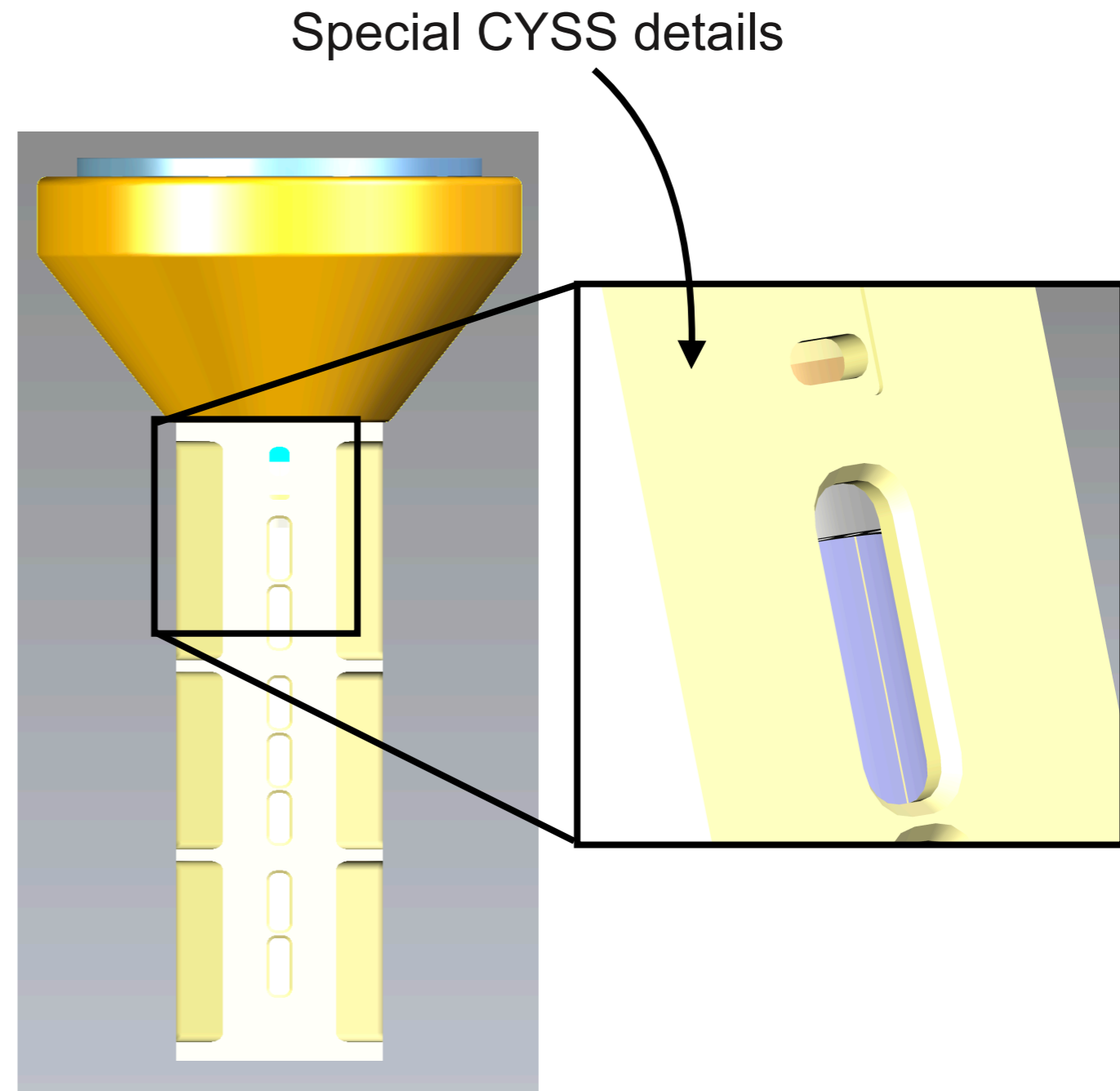

# WP5 activities - BBM6

- ➔ Full setup design
- ➔ Heaters electrical and mechanical design and procurement
- ➔ Silicon dicing

Adapt all the components to the correct radii

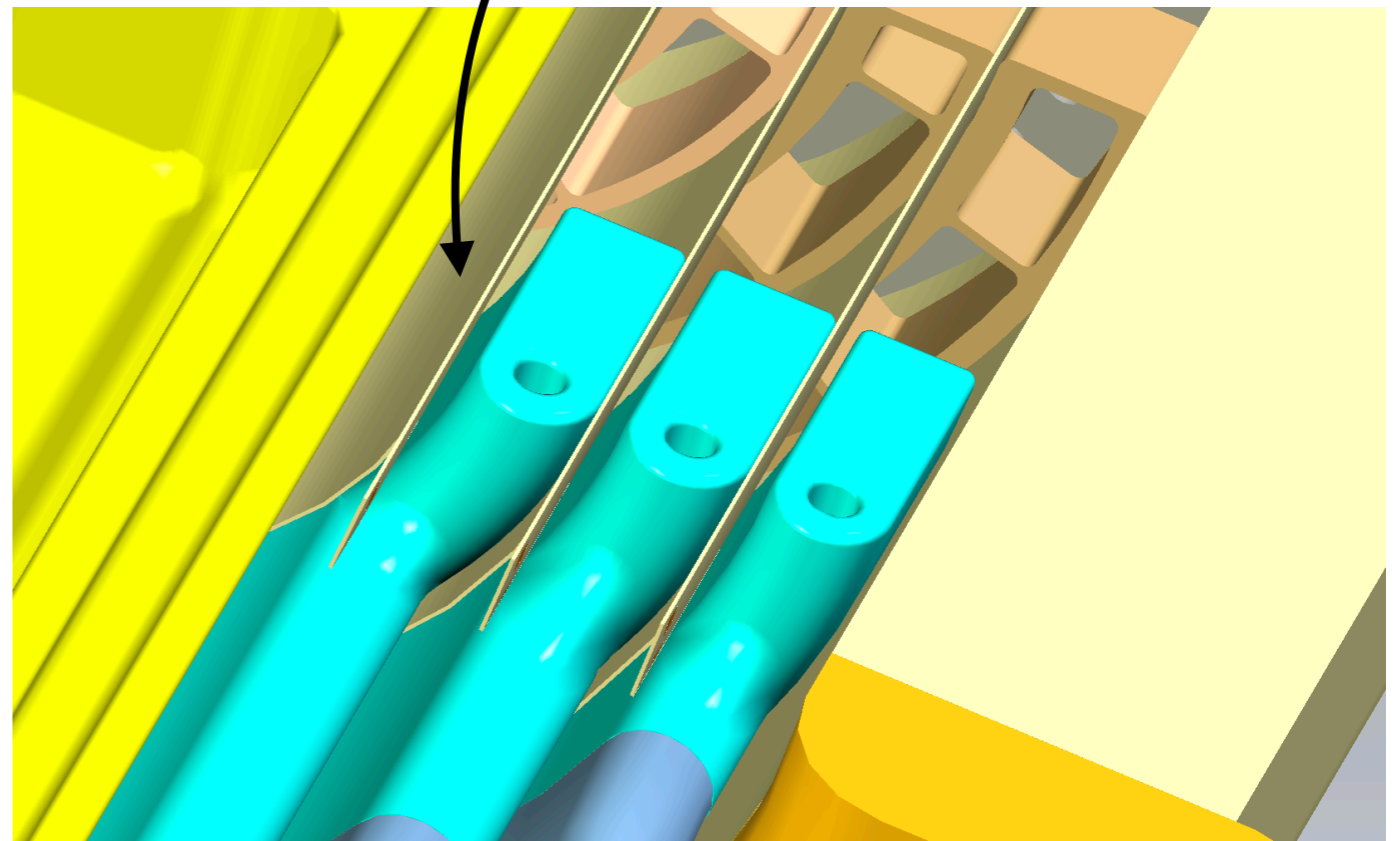



# WP5 activities - BBM6

- ➔ Full setup design
- ➔ Heaters electrical and mechanical design and procurement
- ➔ Silicon dicing

Discussions ongoing with Rui De Oliveira (and M. Angeletti)

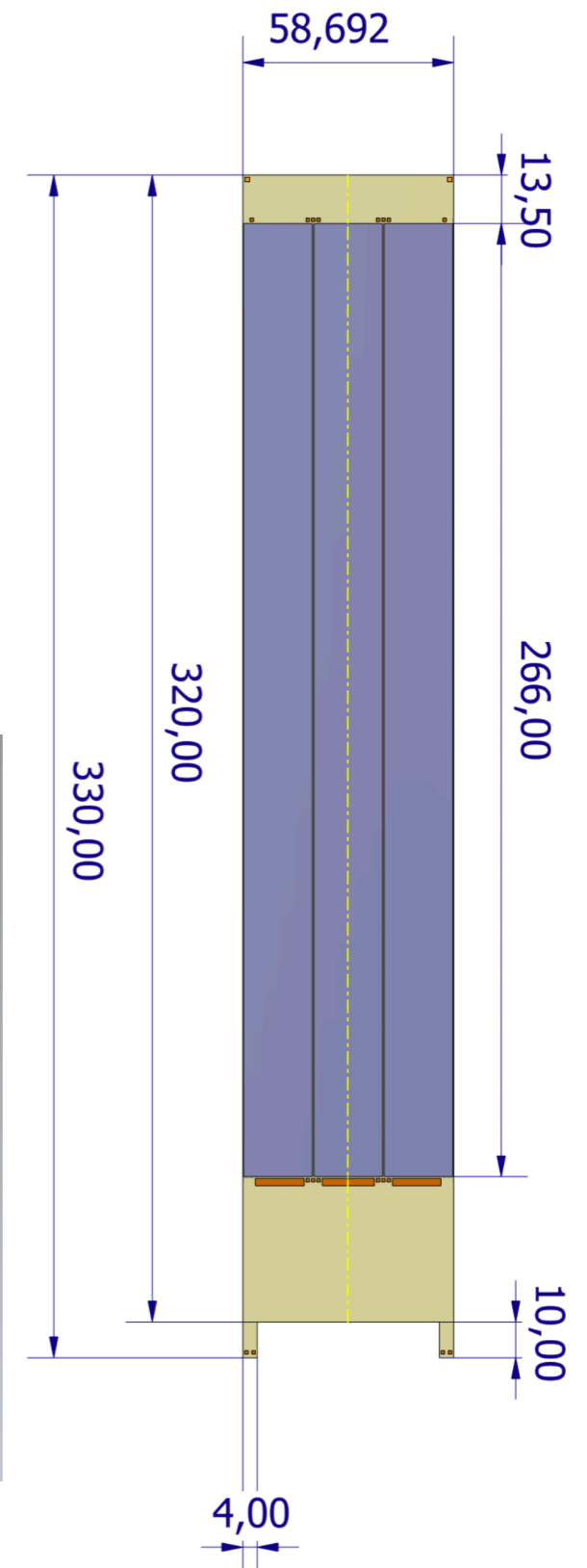
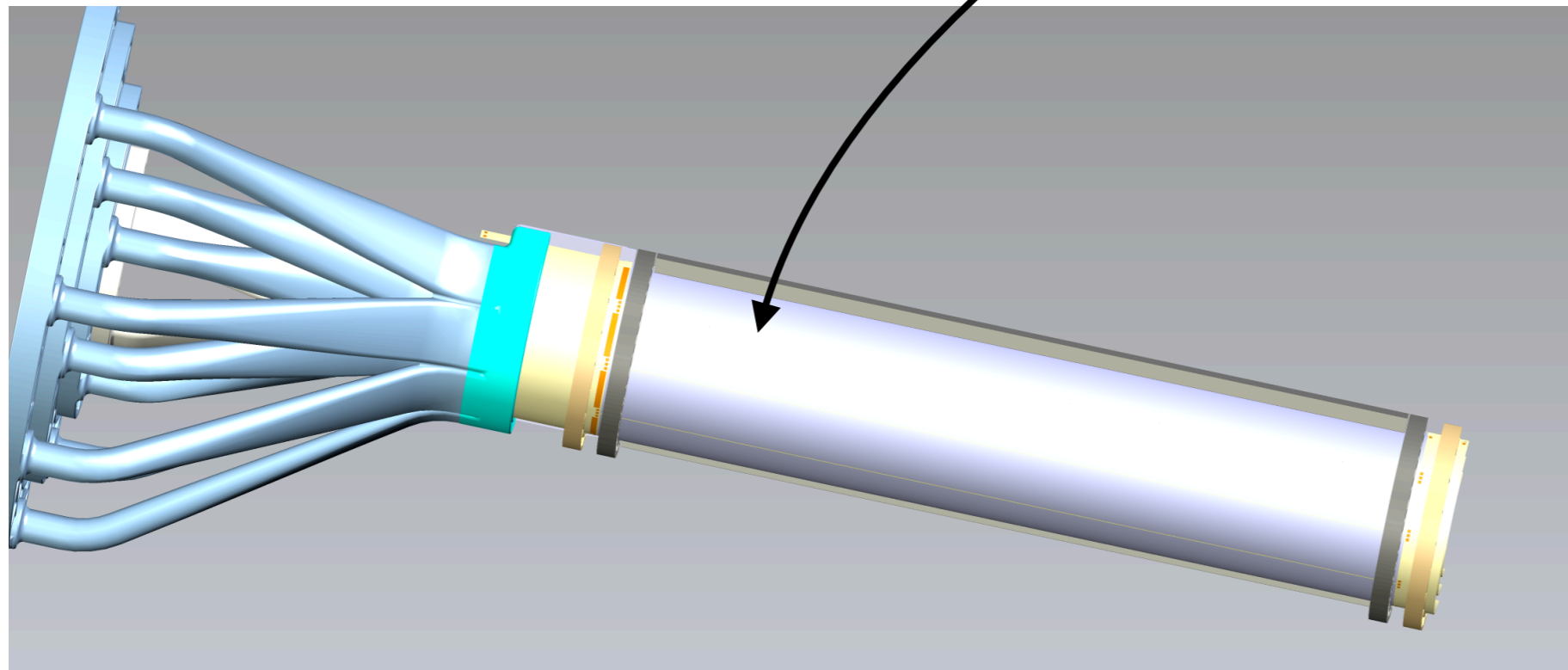

# WP5 activities - BBM6

- ➔ Full setup design
- ➔ Heaters electrical and mechanical design and procurement
- ➔ Silicon dicing

12 ER1 pad-wafers available for dicing  
 Relationship with DISCO in Magnus hands

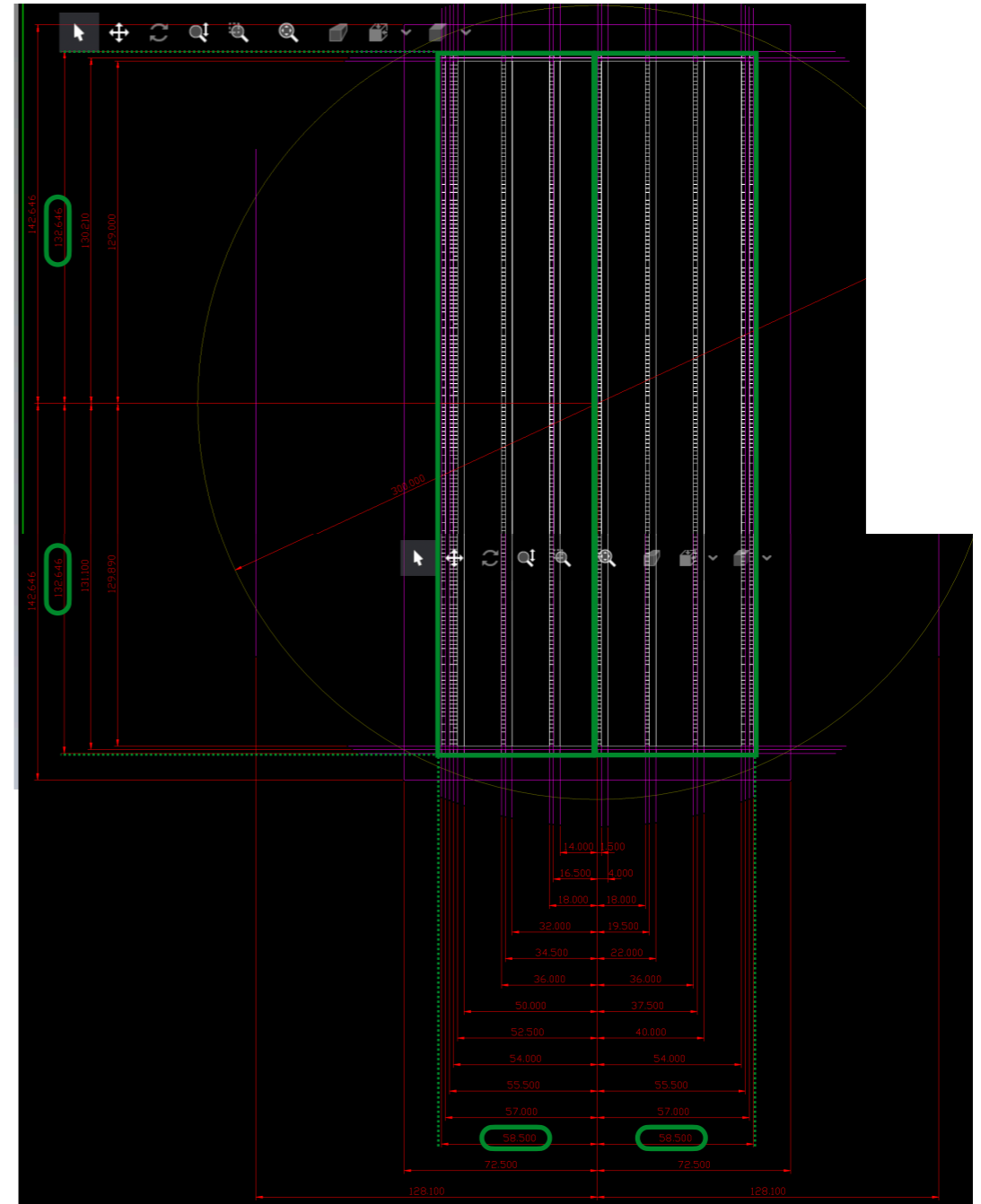
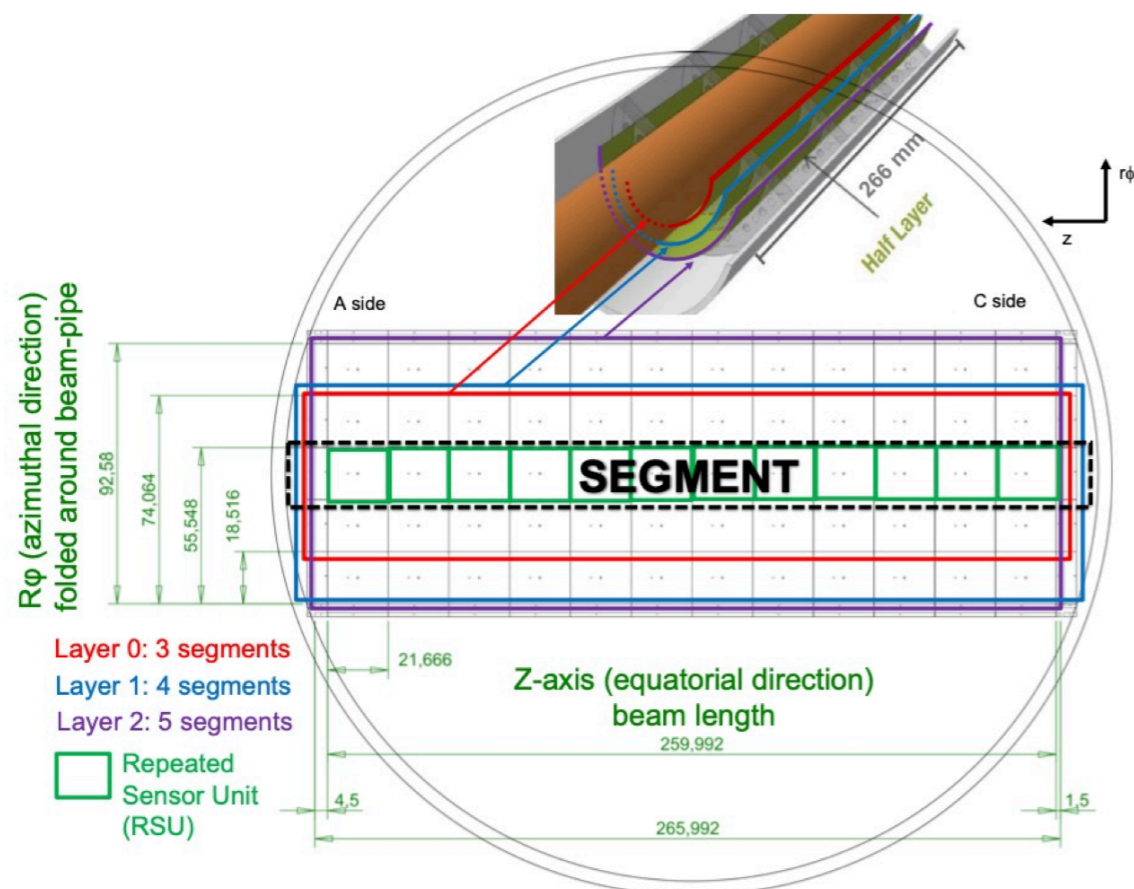

## WP5 activities - BBM6

- ➡ Full setup design
- ➡ Heaters electrical and mechanical design and procurement
- ➡ Silicon dicing
- ➡ **Other: PT1000, etc.**