



Hadronic Contributions to the Muon $g-2$ from Lattice QCD

Marina Krstic Marinkovic (ETHZ)

marinama@ethz.ch

7 March 2023, Les Recontres de Physique, La Thuille 2023

Outline

1. Setting the Stage: **Anomalous Magnetic Moment of the Muon** on the lattice

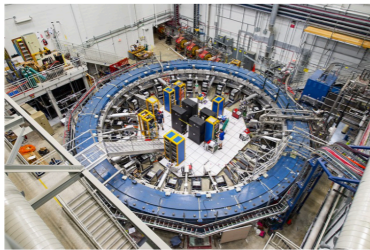

<https://muon-gm2-theory.illinois.edu/white-paper/>
[arXiv:2006.04822](https://arxiv.org/abs/2006.04822)



[arXiv:2201.12102](https://arxiv.org/abs/2201.12102)



[arXiv:2203.15810](https://arxiv.org/abs/2203.15810)

2. **HLbL** from Lattice QCD and QCD+QED

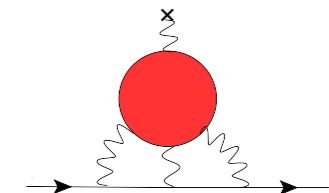
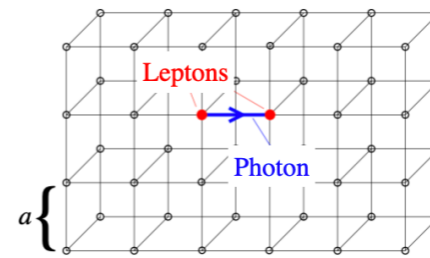
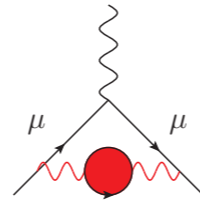
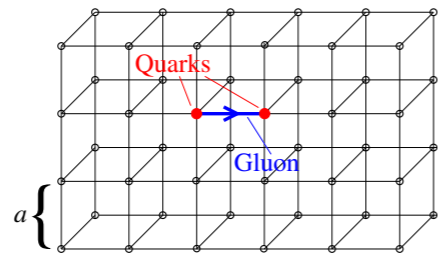
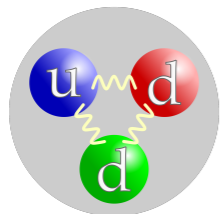

3. **HVP**: Status and New Approaches

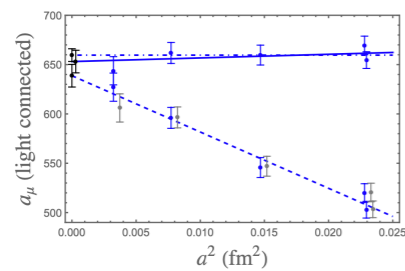

[arXiv:2204.12256](https://arxiv.org/abs/2204.12256)

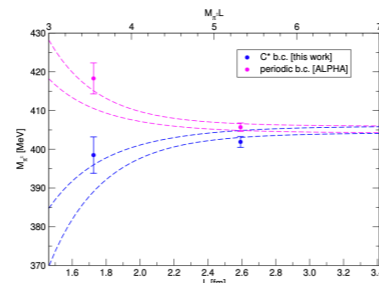

[arXiv:2209.13183](https://arxiv.org/abs/2209.13183)

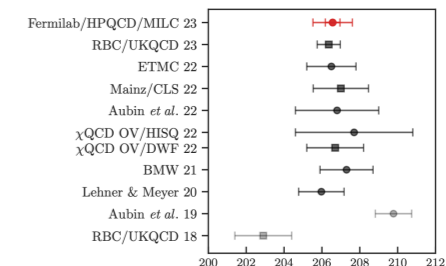
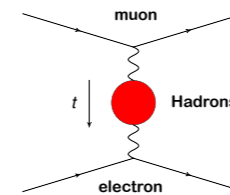

[arXiv:2301.08274](https://arxiv.org/abs/2301.08274)

The magnetic moment of the muon:

$$a_\mu = \frac{g_\mu - 2}{2}$$

EXPERIMENT:

$$a_\mu^{exp} = 11659208.0(6.3) \times 10^{-10} \text{ (0.54ppm)}$$

[BNL E821, 2006-2008]

$$a_\mu^{exp} = 11659204.0(5.4) \times 10^{-10} \text{ (0.46ppm)}$$

[Fermilab Muon g-2, 2018-2021]

THEORY:

$$a_\mu^{th} = 11659181.0(4.3) \times 10^{-10} \text{ (0.37ppm)}$$

[Muon g-2 Theory Initiative,

Phys.Rept. 887 (2020), 1-166]

TENSION: 3.7 σ / 4.2 σ

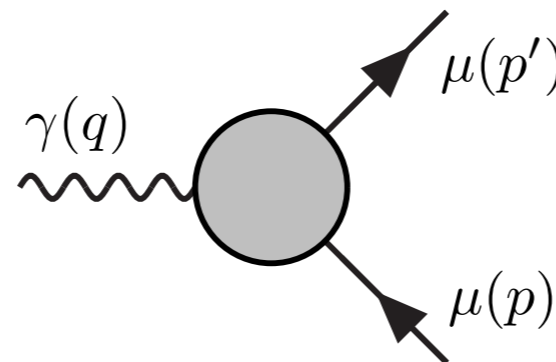

$$a_\mu = \frac{g_\mu - 2}{2}$$

Standard Model:

- (1) Q.E.D.
- (2) Electroweak
- (3) Hadronic

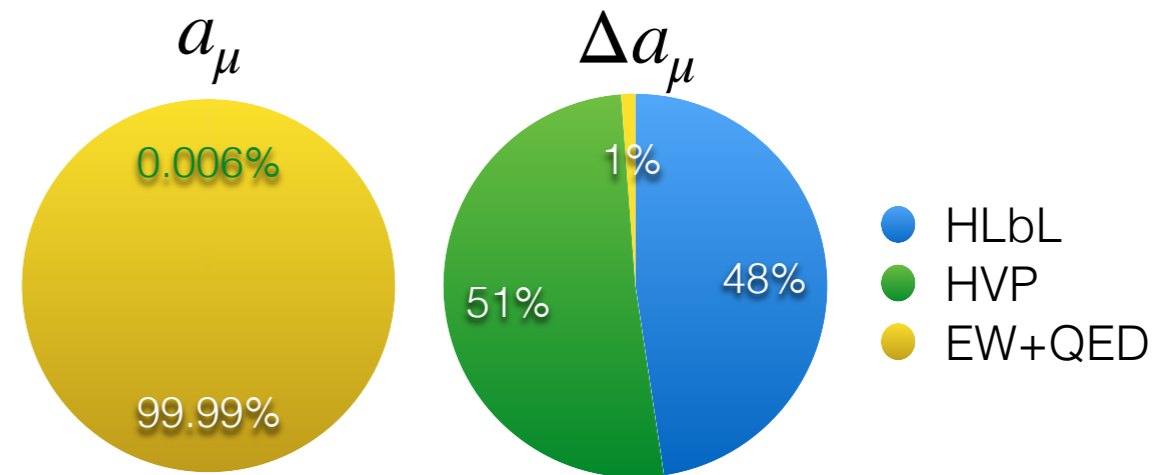

[WP20] T. Aoyama et al, arXiv:2006.04822, Phys. Repts. 887 (2020) 1-166
 White Paper Muon g-2 Theory Initiative: <https://muon-gm2-theory.illinois.edu>

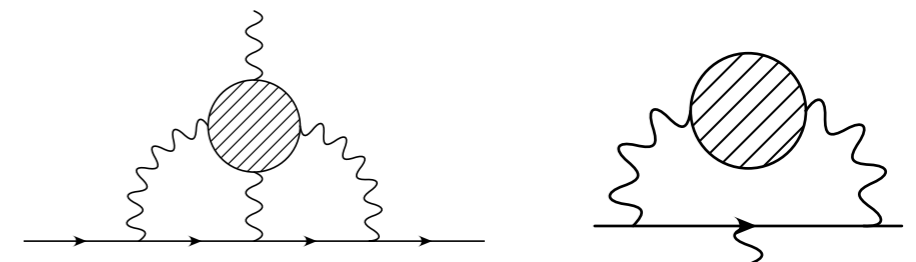

a_μ from experiment: FNAL E989, J-PARC, ...

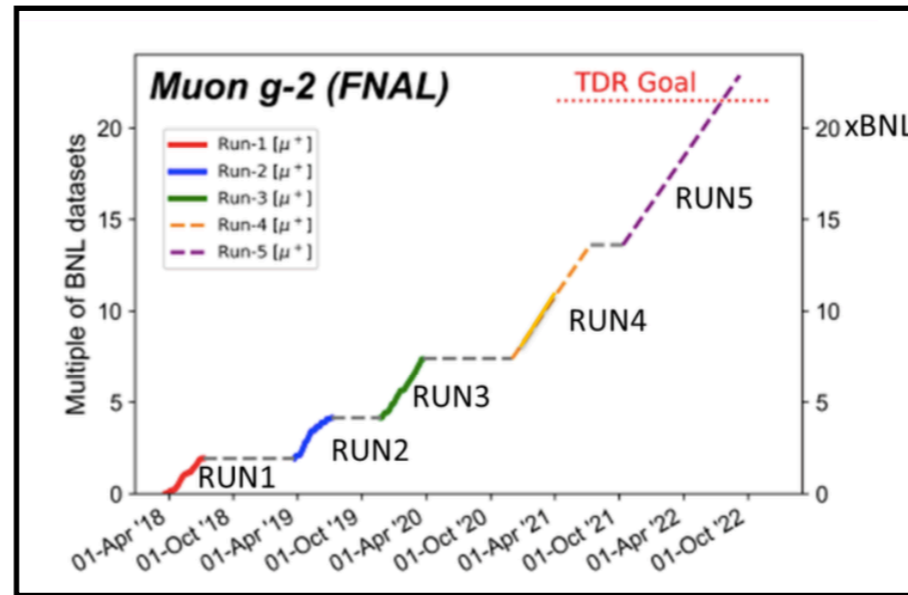

PAUL SCHERRER INSTITUT



[arXiv:2201.12102](https://arxiv.org/abs/2201.12102)

[arXiv:2201.12102](https://arxiv.org/abs/2201.12102)



<https://cds.cern.ch/record/2677471>

D. B. Abi *et al.* (Muon $g-2$ Collaboration)
Phys. Rev. Lett. 126, 141801 – 7 April 2021

[see talk by Paolo Girotti, Tue, 18:35]

- $a_\mu^{exp} = 11659208.0(6.3) \times 10^{-10}$ (0.54ppm) [BNL, 2006-2008]
- $a_\mu^{exp} = 11659204.0(5.4) \times 10^{-10}$ (0.46ppm) [Fermilab, 2018-2021]

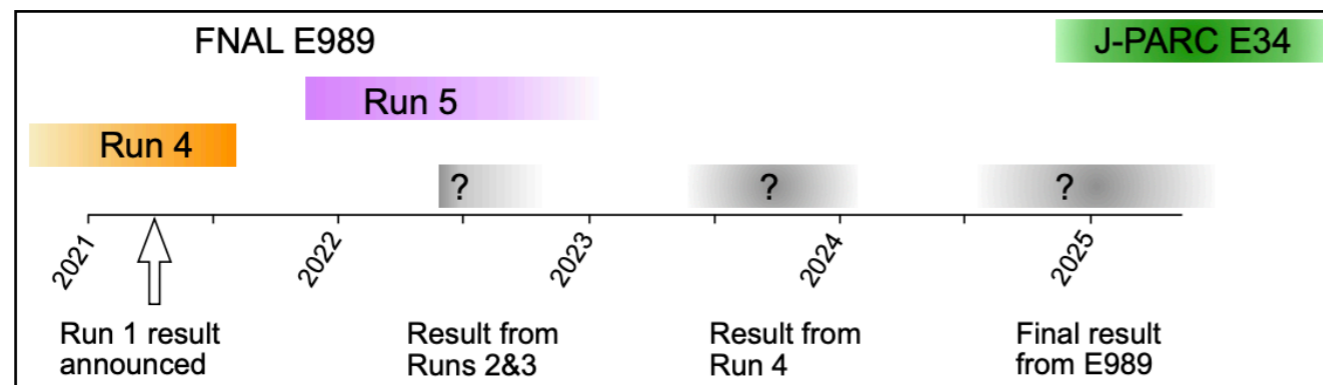
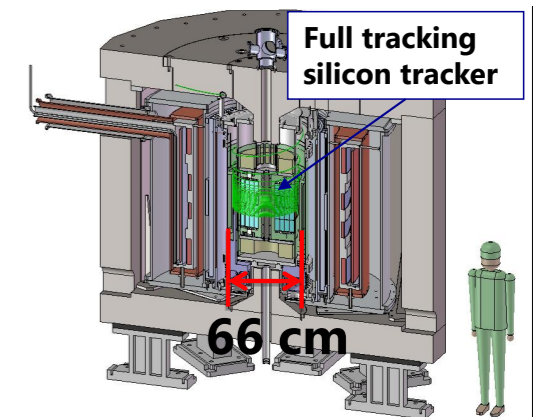

J-PARC
Muon $g-2$ /EDM

Data driven HVP approach: dispersive methods

[see talk by Martin Hoferichter, Tue, 17:45]

- Relation between the $\mathcal{R}e \Pi(Q^2)$ and $\mathcal{I}m \Pi(Q^2)$:

$$\Pi(Q^2) - \Pi(0) = \frac{Q^2}{\pi} \int_0^\infty ds \frac{\mathcal{I}m \Pi(s)}{s(s - Q^2)}$$

- Imaginary part of $\Pi(s)$ is related to the experimental total cross-section in e+e- annihilation:

$$\mathcal{I}m \Pi(s) = \frac{\alpha}{3} R(s)$$

- Important contributions:

- $\rho, \omega, \phi, J/\psi$

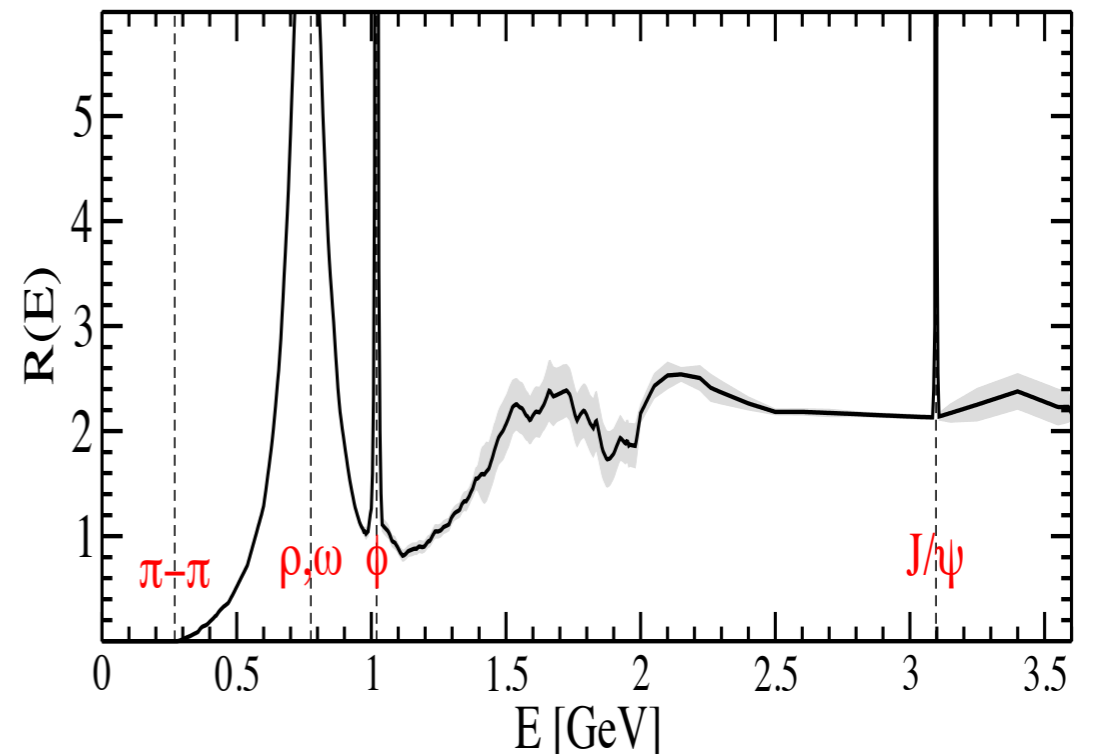

Data driven HVP approach: dispersive methods

[see talk by Martin Hoferichter, Tue, 17:45]

- Relation between the $\mathcal{R}e \Pi(Q^2)$ and $\mathcal{I}m \Pi(Q^2)$:

$$\Pi(Q^2) - \Pi(0) = \frac{Q^2}{\pi} \int_0^\infty ds \frac{\mathcal{I}m \Pi(s)}{s(s - Q^2)}$$

- Imaginary part of $\Pi(s)$ is related to the experimental total cross-section in e^+e^- annihilation:

$$\mathcal{I}m \Pi(s) = \frac{\alpha}{3} R(s)$$

- Other than: $\rho, \omega, \phi, J/\psi$
- O(1000)** channels
- Model calculations had to be used for some channels
- [Keshavarzi, Nomura, Teubner, Phys.Rev. D97 (2018) no.11]

Lattice QCD (+QED) provide a way to compute these contributions in a model-independent way

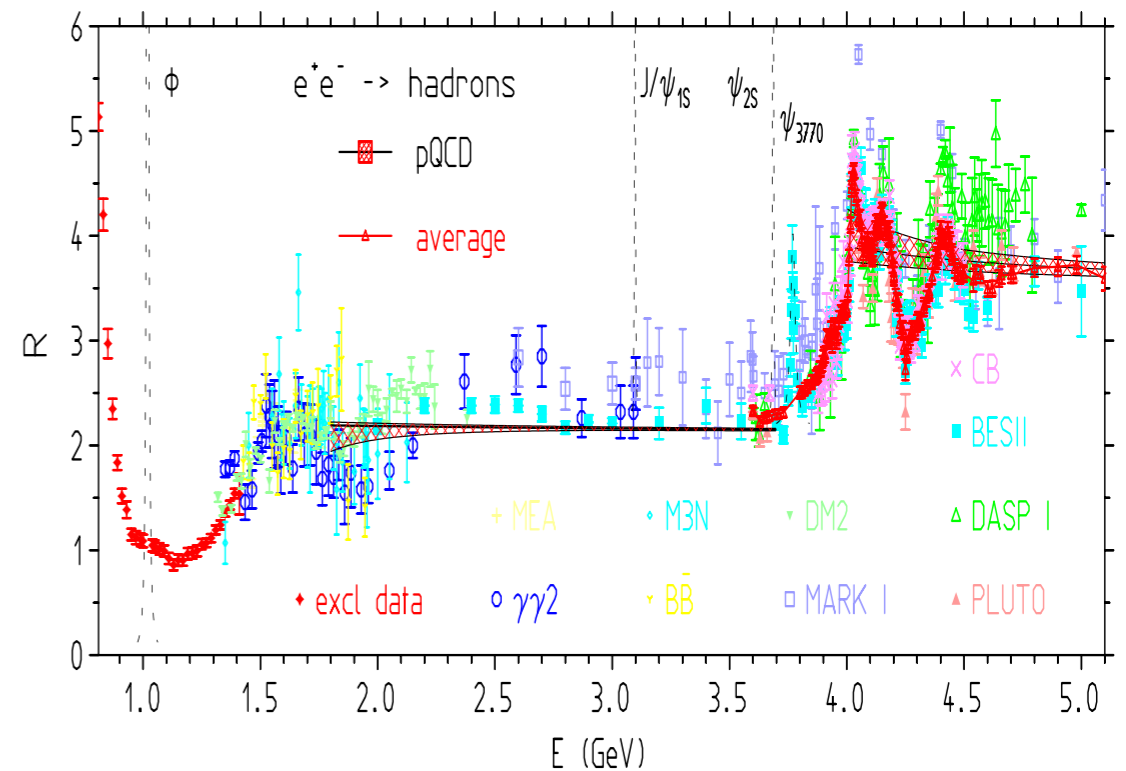

Non-perturbative treatment of QCD

- Systematic method for computing hadronic observables from first principles
- “Sacrifice” $N_f + 1$ observables to fix the parameters (e.g. hadron masses), and everything else is a prediction of the theory

$$\mathcal{L}_{QCD}^E = \frac{1}{2g} F_{\mu\nu}^a F_{\mu\nu}^a + \sum_{f=u,d,s,\dots} \bar{\psi}_f \{ \gamma_\mu (\partial_\mu + iA_\mu^a T^a) + m_f \} \psi_f$$

$$S_{QCD}^E = \int d^4x \mathcal{L}_{QCD}^E$$

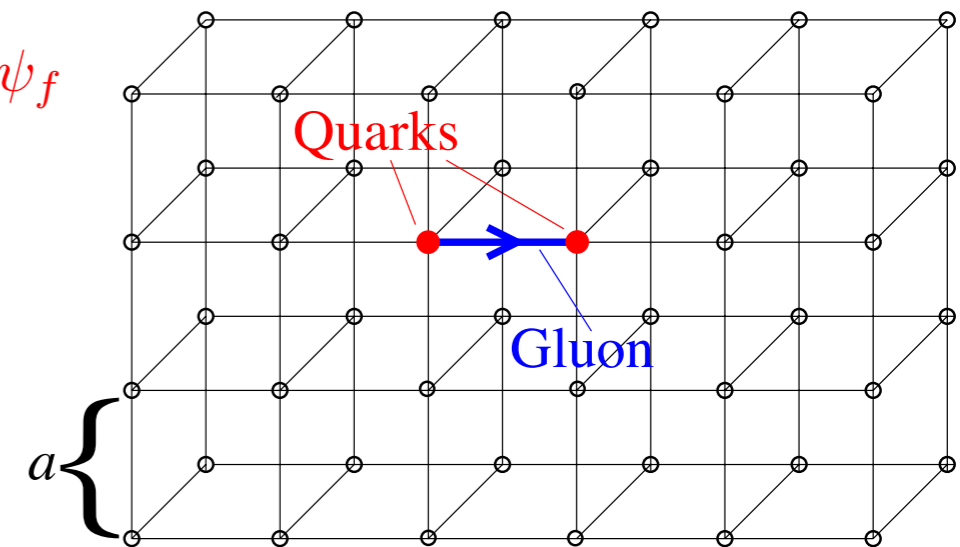

Independent calculations using different choice of the discretization for **S_G** and **S_F**. Results agree once continuum limit is taken!

Lattice QCD: choice of fermion discretization

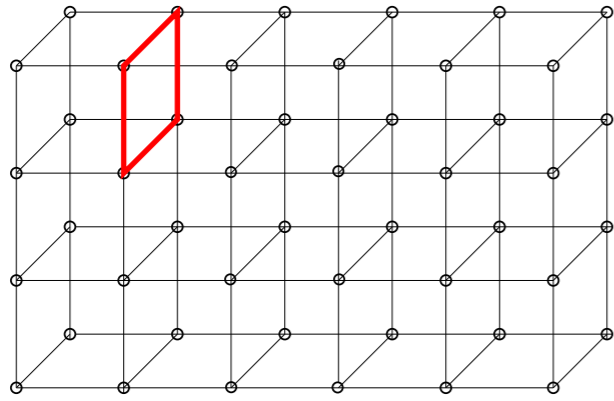

Wilson's (plaquette) Gauge Action

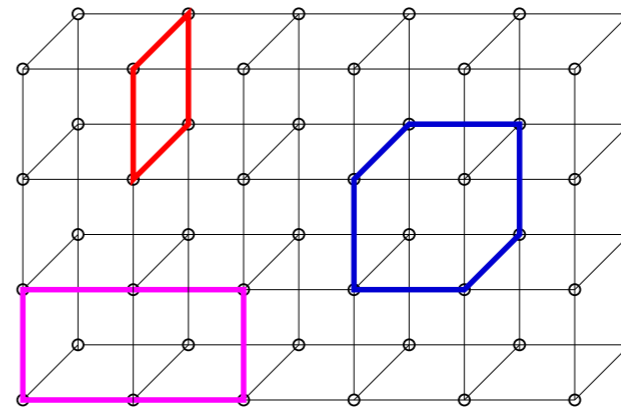

Luscher-Weisz Gauge Action

Iwasaki Gauge Action

- Different lattice collaborations



- Different discretization prescription for fermionic action

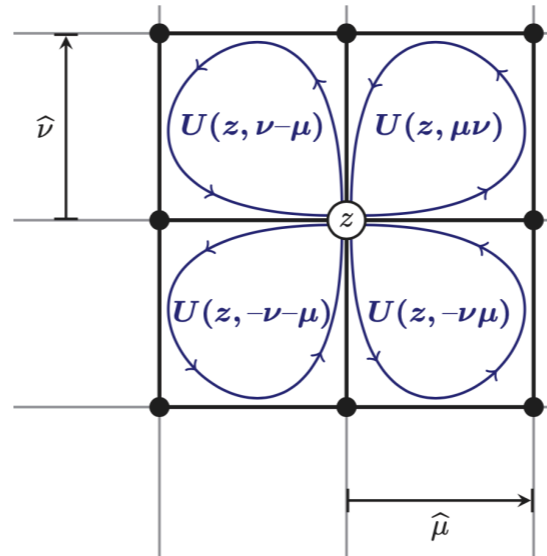

Improved Wilson Fermions

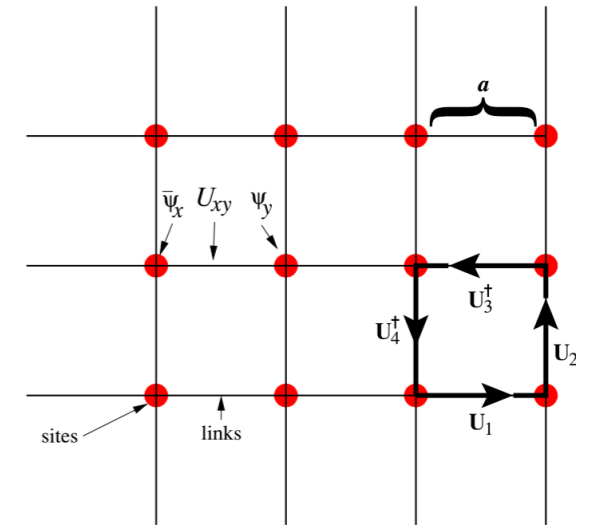

Staggered Fermions

Results agree once continuum limit is taken!

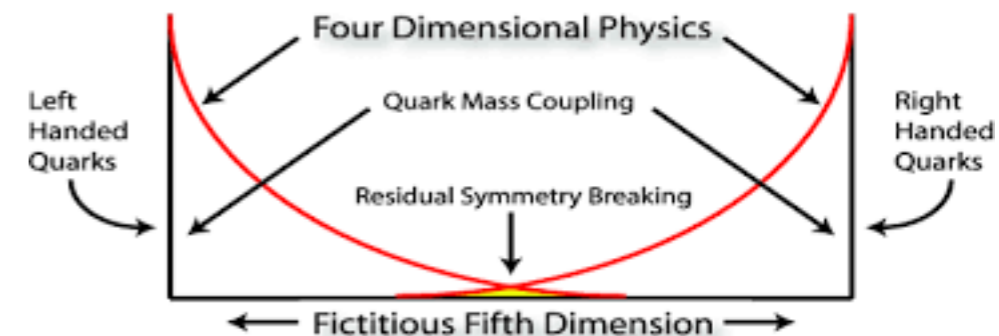

Doman Wall Fermions

Recipe for Lattice QCD Computation

- (1) Generate ensembles of field configurations using *Monte Carlo*
- (2) Average over a set of configurations:
 - Compute correlation function of fields, extract Euclidean matrix elements or amplitudes
 - Computational cost dominated by quarks: inverses of large, sparse matrix
- (3) Extrapolate to continuum, infinite volume, physical quark masses (now directly accessible)

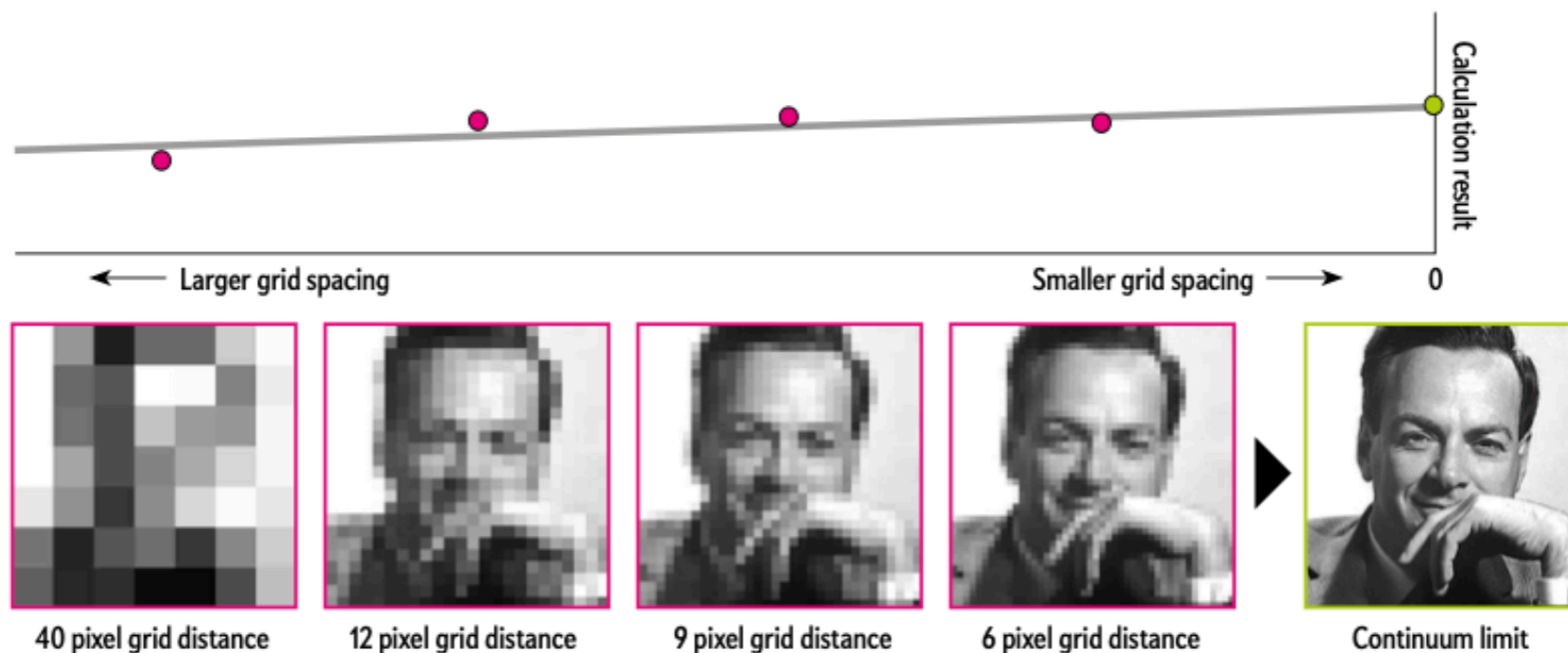

Beyond Lattice QCD

- Important source of systematics:
 - ➔ neglecting/incomplete treatment of **isospin breaking effects**

First decades of Lattice QCD, typically: $m_u = m_d$ and $\alpha_{em} = 0$

❖ Few percent effects: $\frac{m_u - m_d}{M_p} \simeq 0.3\%$ $\alpha_{EM} = 0.7\%$ $\frac{M_n - M_p}{M_n} \simeq 0.1\%$

❖ Have to be taken into account for the goal precision: $\frac{\Delta a_\mu^{HVP}}{a_\mu^{HVP}} \approx 0.002$

$$\frac{\Delta f_+(0)}{f_+(0)} \approx 0.002 - 0.003$$

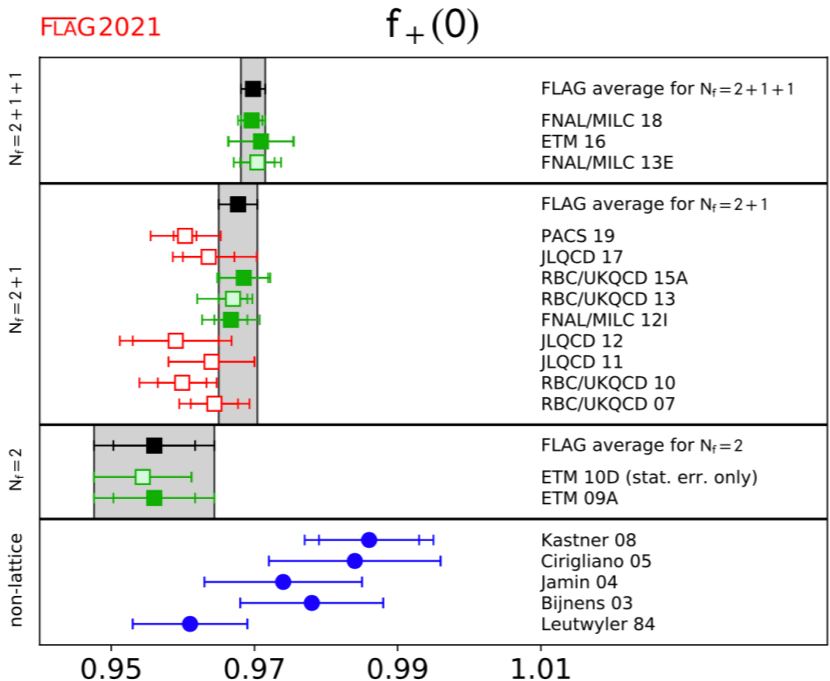

[FLAG21 2203.15810 [hep-ph]]

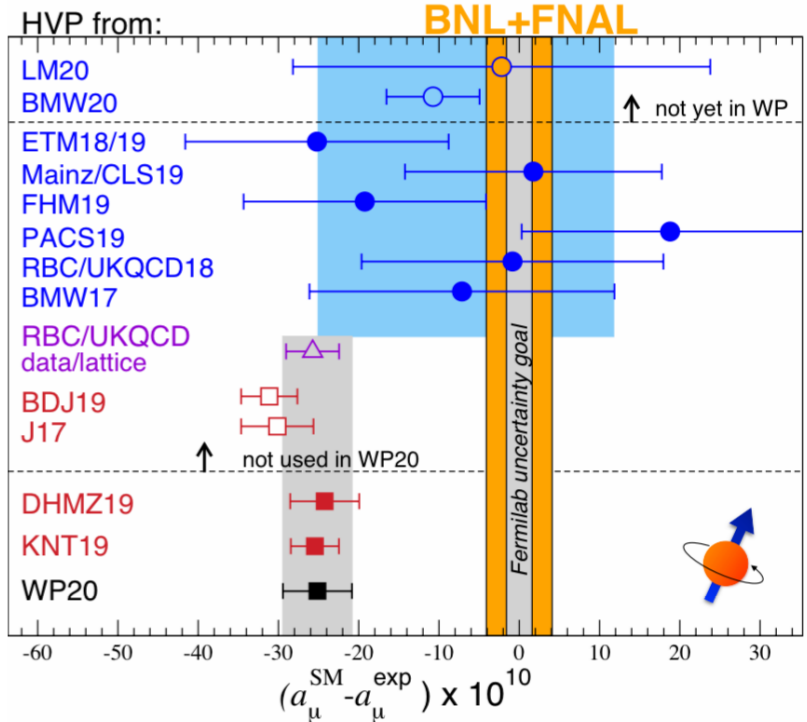

[Snowmass22 2203.15810 [hep-ph]]

Beyond Lattice QCD

- Important source of systematics:

➔ neglecting/incomplete treatment of **isospin breaking effects**

$$m_u \neq m_d \text{ and } \alpha_{em} \neq 0$$

➔ expand about iso-symmetric theory

QCD TREATED NON-
PERTURBATIVELY,
 α_{em} "SMALL"

[R123: 1303.4896, PRD87(2013)11]

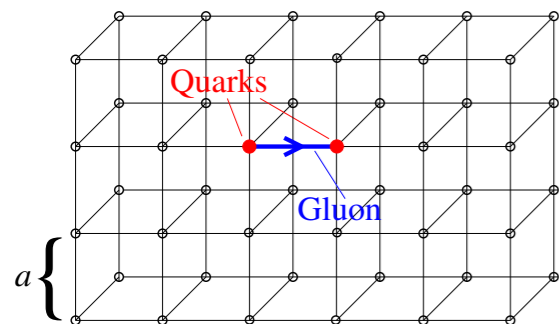

$$O(\alpha_{em}), O(m_u - m_d)$$

➔ simulate QED+QCD

QCD AND QED TREATED
NON-PERTURBATIVELY,

[Duncan,Eichten, hep-lat/9602005, PRL76(1996),
Blum et al. 0708.0484 PRD 76 (2007)114508, ...]
[BMW: 1406.4088 Science 347 (2015),
QCDSF: 1509.00799, JHEP 04(2016) 093,
RCstar: 2209.13183 JHEP03(2023)012, ...]

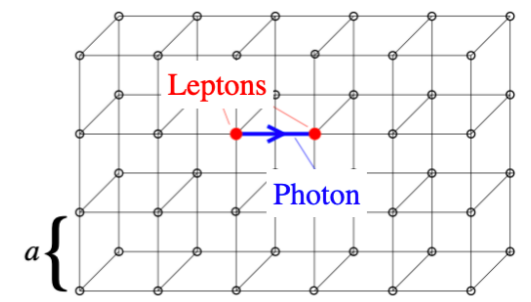
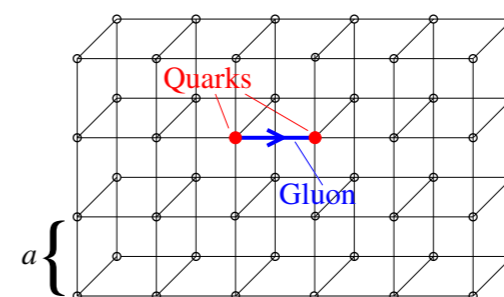

Challenges for IB effects lattice computation

- **FV effects** ← the way the infrared divergence associated with the zero momentum mode of the photon propagator is canceled on the lattice:

→ continuum: $\alpha_{em} \int \frac{d^4 k}{(2\pi)^4} \frac{1}{k^2} \dots$ → lattice: $\frac{\alpha_{em}}{V} \sum_k \frac{1}{k^2} \dots$

- Gauss law does not allow a non-zero charge to exist in a finite periodic box: $q(t) = \int d^3 x \rho(t, \mathbf{x}) \equiv 0$
- Three ways to deal with IR divergence:
 - **Modify gauge field**: removing the global zero-mode/ spatial zero mode per timeslice (QED_{TL}/QED_L) [PRL76(1996), Prog. Theor. Phys. 120(2008)413, Science 347 (2015) 1406.4088, ...]
 - **Massive photon** [PRL 117 (2016) 7, PoS LATTICE2021 (2022) 281]
 - QED_∞ [Phys. Rev. D 96 (2017), Phys. Rev. D 100 (2019) 094509]
 - **C* boundary conditions** (no zero-mode present) [JHEP 1602, 076, EPJC 80 (2020) 3, JHEP03(2023)012]

Beyond Lattice QCD

- Important source of systematics:
 - ➔ neglecting/incomplete treatment of **isospin breaking effects**

$$m_u \neq m_d \text{ and } \alpha_{em} \neq 0$$

- ➔ expand about iso-symmetric theory

QCD TREATED NON-
PERTURBATIVELY,
 α_{em} "SMALL"

- ➔ simulate QED+QCD

QCD AND QED TREATED
NON-PERTURBATIVELY,

HVP:

[R123: 1303.4896, PRD87(2013)11]

[RBC/UKQCD: JHEP09 (2017) 153,
PRL121(2018)022003]

[BMW: Borsanyi et al. Nature 593 (2021)7857]

[Mainz: PRD106(2022)11]

...

RC*CD

[openQ*D: <https://gitlab.com/rcstar/openQxD>]

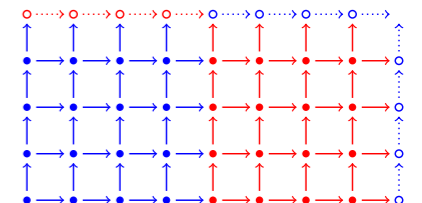

[RCstar: Campos et al. Eur.Phys.J.C 80 (2020) 3, Bushnaq et al. JHEP03(2023)012]

HVP: [RCstar: Altherr et al. PoS LATTICE2022 (312), PoS LATTICE2022 (281)]

Recipe for Lattice QCD Computation

- (1) Generate ensembles of field configurations using *Monte Carlo*
- (2) Average over a set of configurations:
 - Compute correlation function of fields, extract Euclidean matrix elements or amplitudes
 - Computational cost dominated by quarks: inverses of large, sparse matrix
- (3) Extrapolate to continuum, infinite volume, physical quark masses (now directly accessible)

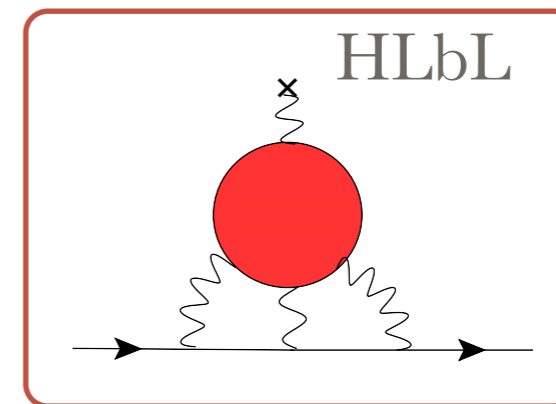
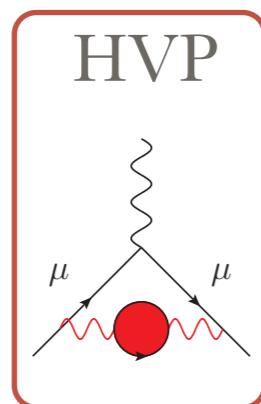

Muon g-2 Light-By-Light Contribution

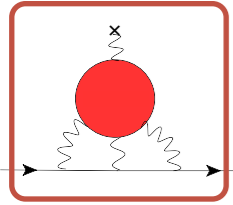

- Target relative precision: $\leq 10\%$
- ➔ Calculations not as mature as the lattice HVP determinations

Two completely independent methods/calculations

❖ RBC/UKQCD ($QCD + QED_L$):

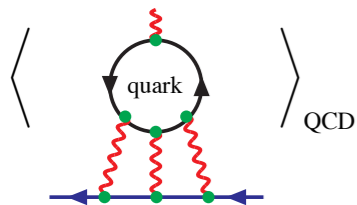

[Blum, Izubuchi, Hayakawa, PoS (LAT2005)353 hep-lat/0509016, +Chowdhury, 1407.2923 PRL114(2015)1]

❖ Mainz group ($QCD + QED_{\infty/\text{cont.}}$):

$$a_{\mu}^{HLbL} \propto \int f'(q^2) e^{iqx} \langle J_{\mu}(x_1) J_{\nu}(x_2) J_{\rho}(x_3) J_{\sigma}(x_4) \rangle$$

[P. Rakow (QCDSF), Glasgow 2007]

[Colangelo, Hoferichter, Procura, Stoffer, 1402.7081 JHEP09(2014)091, 1506.01386 JHEP09(2015)074]

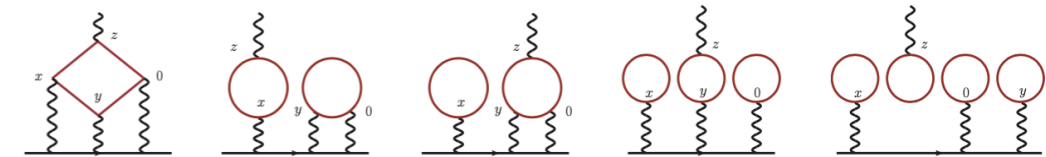

[Chao et al, 2104.02632, EPJC81(2021)651, 2204.08844 EPJC82(2022)8]

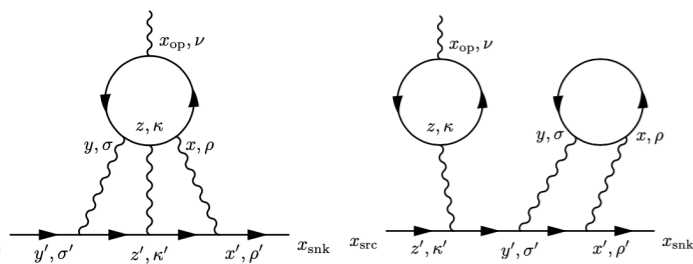

[T. Blum et al, 1610.04603, PRL118 (2017)2, 1911.08123, PRL124(2020)13]

➔ Crosschecks between the two approaches in WP20

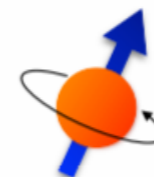

<https://muon-gm2-theory.illinois.edu/white-paper/>

[Phys.Rept.887, arXiv:2006.04822]

Muon g-2 Light-By-Light Contribution

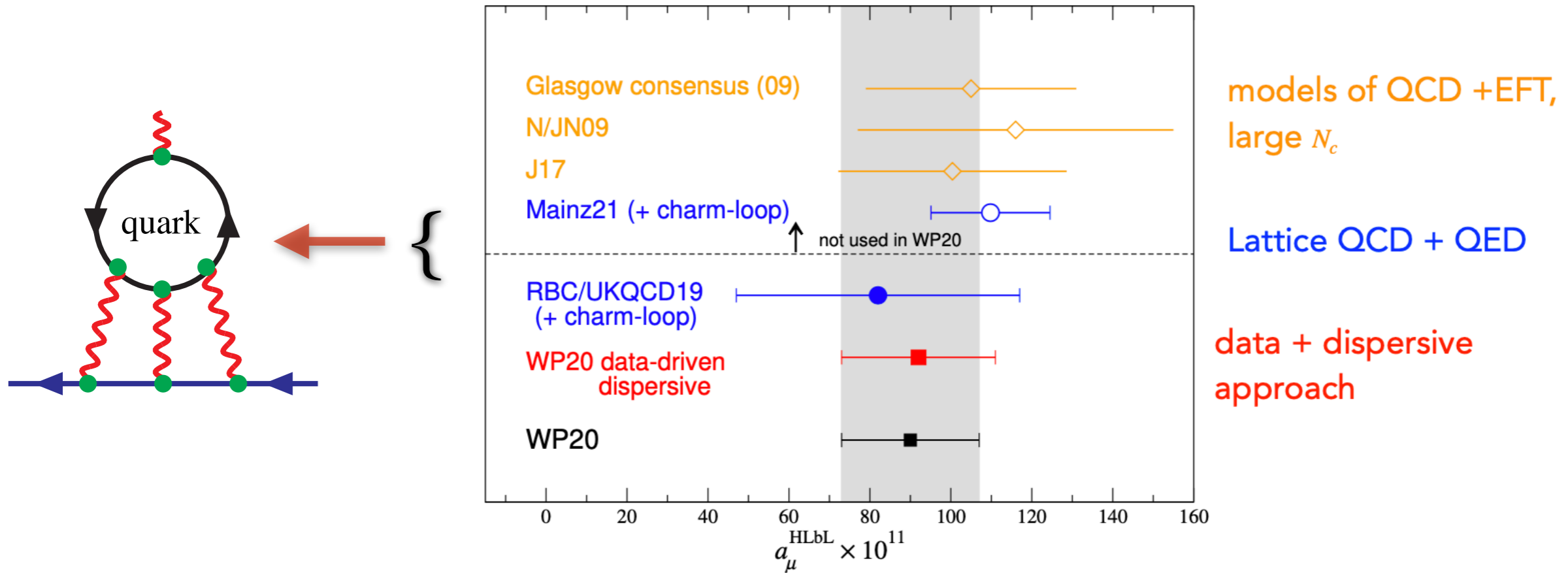

[A. El-Khadra, LATTICE 2021]

➔ Pseudoscalar pole contributions to the muon g-2:

[Mainz: Gerardin et. al 1607.08174 PRD94 (2016), Gerardin et. al 1903.09471 PRD100(2019), BMW: Verplanke et. al, PoS LATTICE2022 (332), ETMC: Alexandrou et al., 2212.06704 , 2212.10300 PoS LATTICE2022(306), 2112.03586 PoS LATTICE2021(519)]

Recipe for Lattice QCD Computation

- (1) Generate ensembles of field configurations using *Monte Carlo*
- (2) Average over a set of configurations:
 - Compute correlation function of fields, extract Euclidean matrix elements or amplitudes
 - Computational cost dominated by quarks: inverses of large, sparse matrix
- (3) Extrapolate to continuum, infinite volume, physical quark masses (now directly accessible)

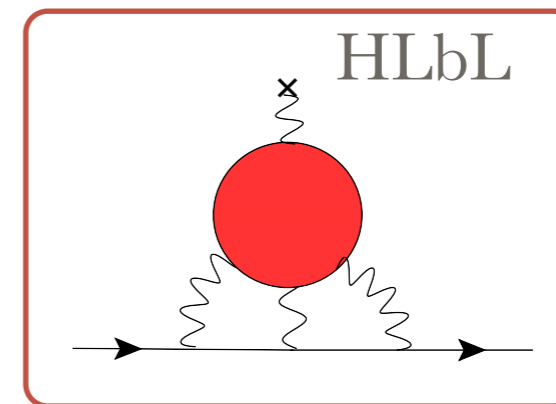
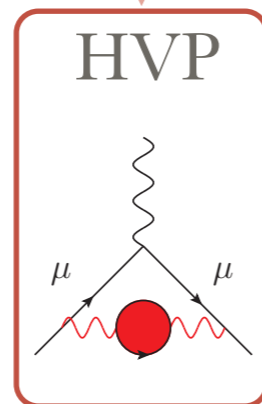

Lattice HVP: dominant sources of errors

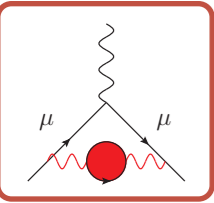

[Bernecker & Meyer, 1107.4388 EPJA47 (2011) 148]

- Understanding the systematics is extremely important:

- deterioration of signal at large distances
- disconnected diagrams
- discretization effects
- continuum extrapolation ...

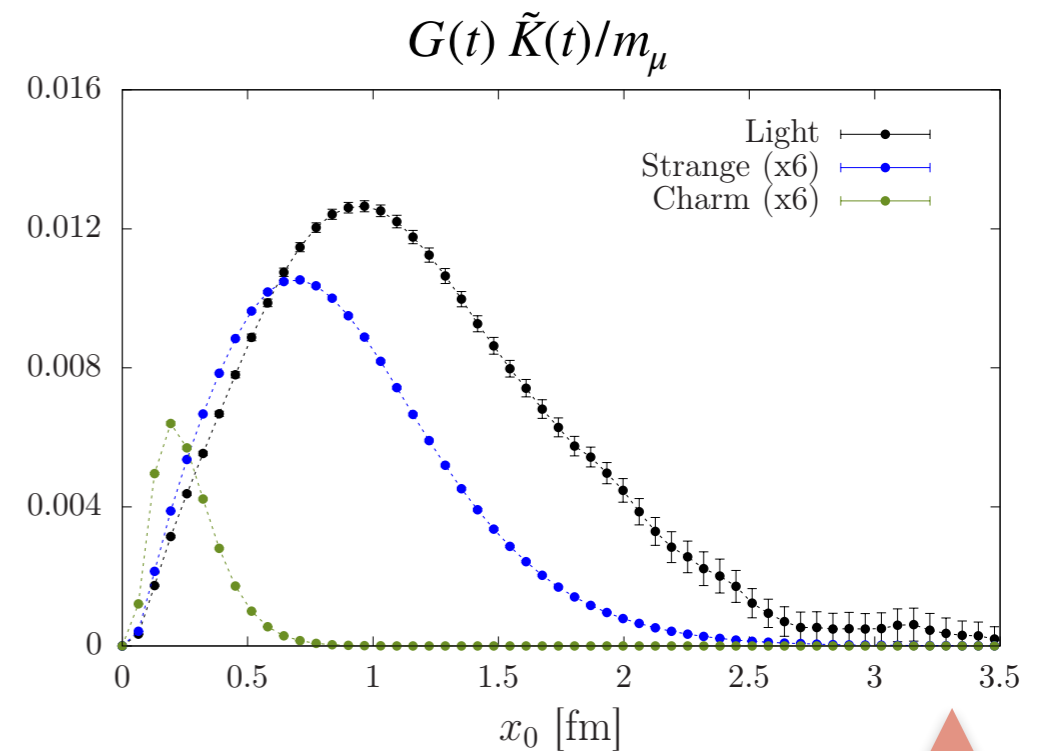

Mainz/CLS [H. Wittig@Lat18]

Time-momentum representation: current-current correlator, summed over all distances:

$$G^f(t) = -\frac{1}{3} \sum_k \sum_{\mathbf{x}} \langle j_k^f(\mathbf{x}, t) j_k^f(\mathbf{0}, 0) \rangle; \quad f = u, d, s, c$$

And only then integrated in time:

$$a_\mu^{HVP} = \left(\frac{\alpha}{\pi}\right)^2 \int_0^\infty dt G(t) \tilde{K}(t, m_\mu)$$

Lattice HVP: dominant sources of errors

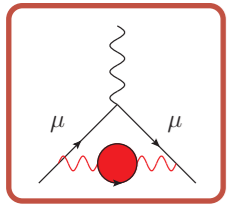

- Understanding the systematics is extremely important:
 - deterioration of signal at large distances ($Q^2 \rightarrow 0$)
 - disconnected diagrams
 - discretization effects
 - continuum extrapolation ...
 - isospin breaking effects
 - scale setting error
 - finite volume effects
 - charm quark

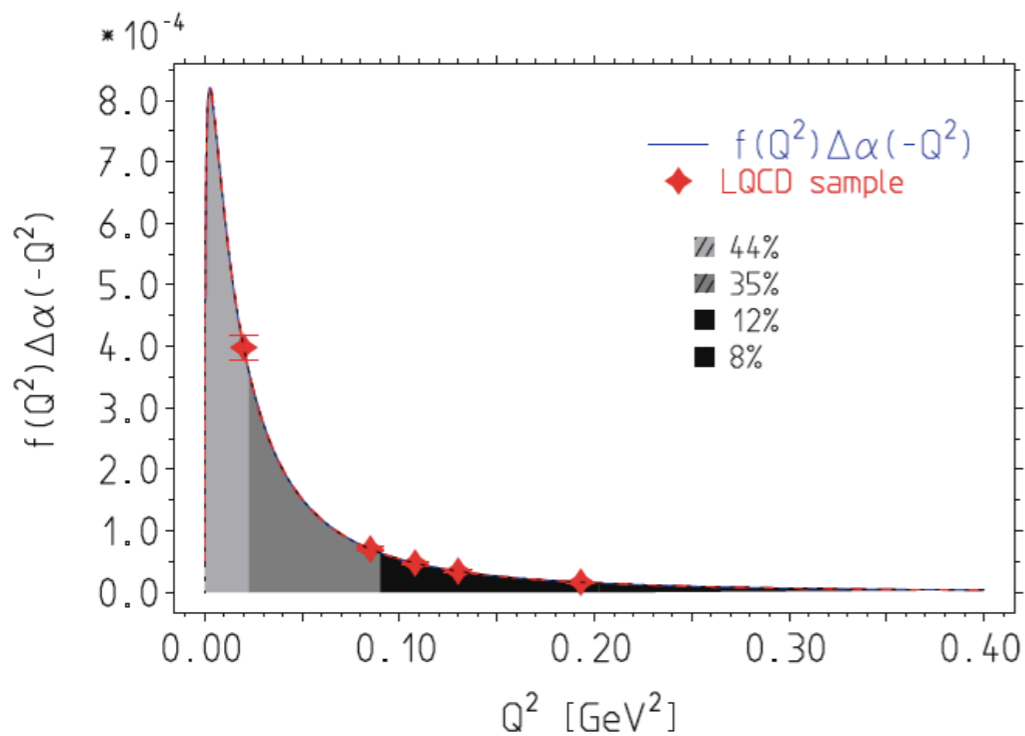

[F. Jegerlehner, 2017]

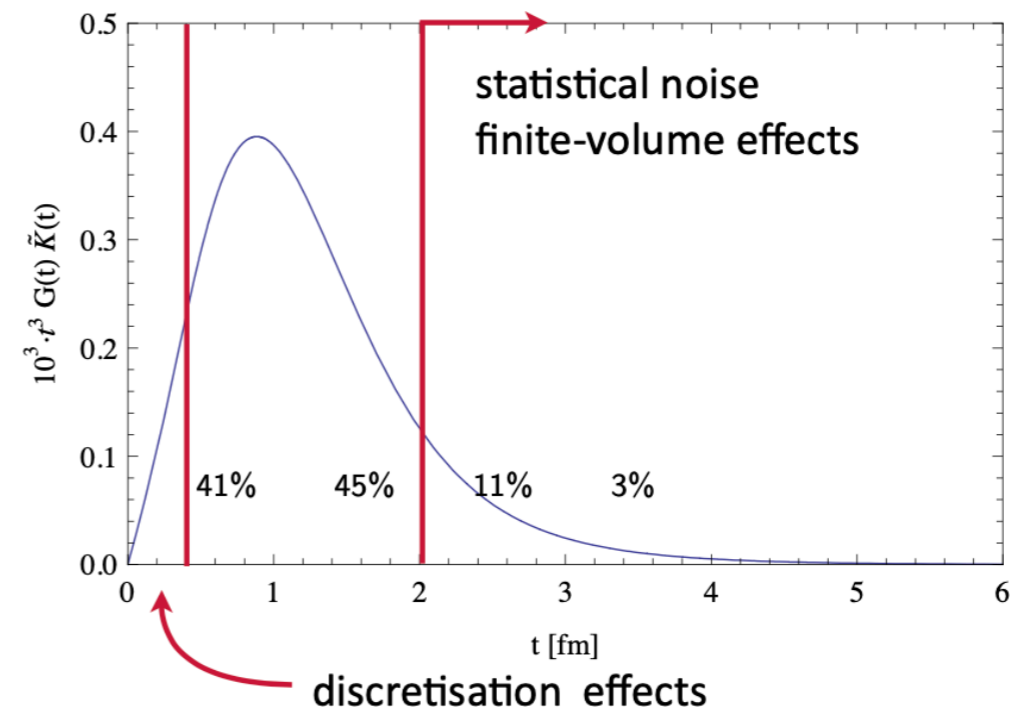

[H.Wittig, SchwingerFest22]

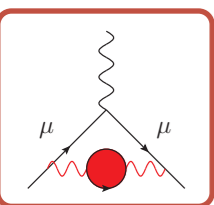

HVP Euclidean Window Quantities

$$a_{\mu}^{\text{HVP, LO}} = a_{\mu}^{\text{SD}} + a_{\mu}^{\text{W}} + a_{\mu}^{\text{LD}},$$

$$a_{\mu}^{\text{SD}} = \left(\frac{\alpha}{\pi}\right)^2 \int_0^{\infty} dx_0 C(x_0) \tilde{f}(x_0) [1 - \Theta(x_0, t_0, \Delta)],$$

$$a_{\mu}^{\text{W}} = \left(\frac{\alpha}{\pi}\right)^2 \int_0^{\infty} dx_0 C(x_0) \tilde{f}(x_0) [\Theta(x_0, t_0, \Delta) - \Theta(x_0, t_1, \Delta)],$$

$$a_{\mu}^{\text{LD}} = \left(\frac{\alpha}{\pi}\right)^2 \int_0^{\infty} dx_0 C(x_0) \tilde{f}(x_0) \Theta(x_0, t_1, \Delta),$$

[RBC/UKQCD: Blum et al. 1801.07224 PRL 121(2018)022003]

[BMW: Borsanyi et al. 2002.12347 Nature 593 (2021)7857]

[Phys.Rept.887, arXiv:2006.04822]

[Mainz 2002.12347 PRD106(2022)11]

[Fermilab/HPQCD/MILC 2301.08274]

[0.4fm – 1.0fm] \approx 30 % of a_{μ}^{HVP}

◆ Easy to compare with dispersive methods:
[Colangelo et al. 2205.12963 Phys.Lett.B 833 (2022)]

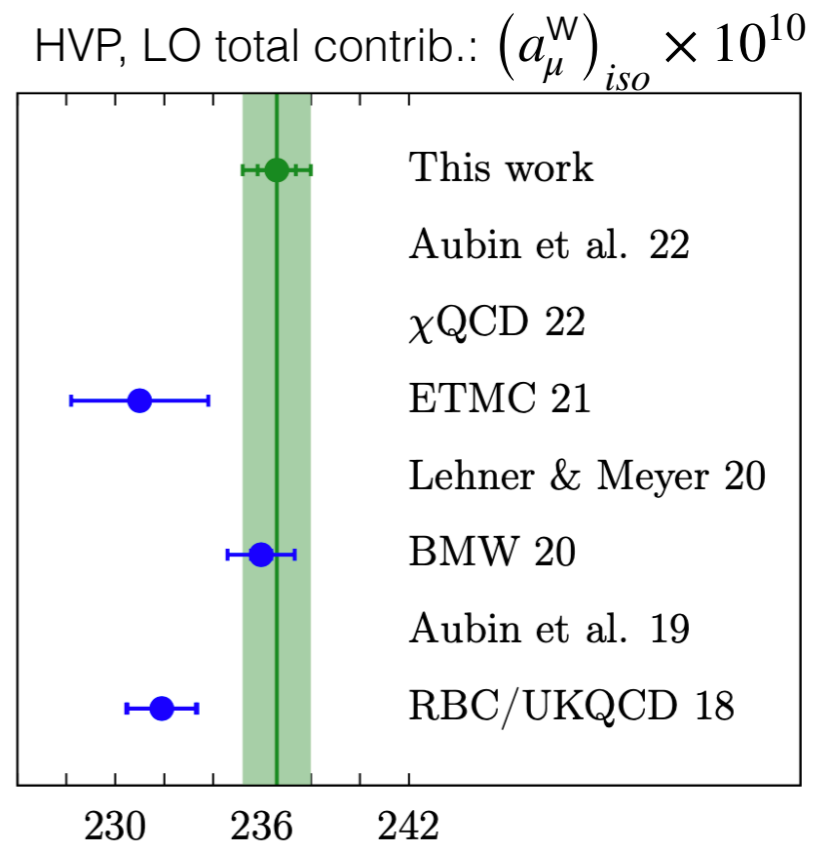
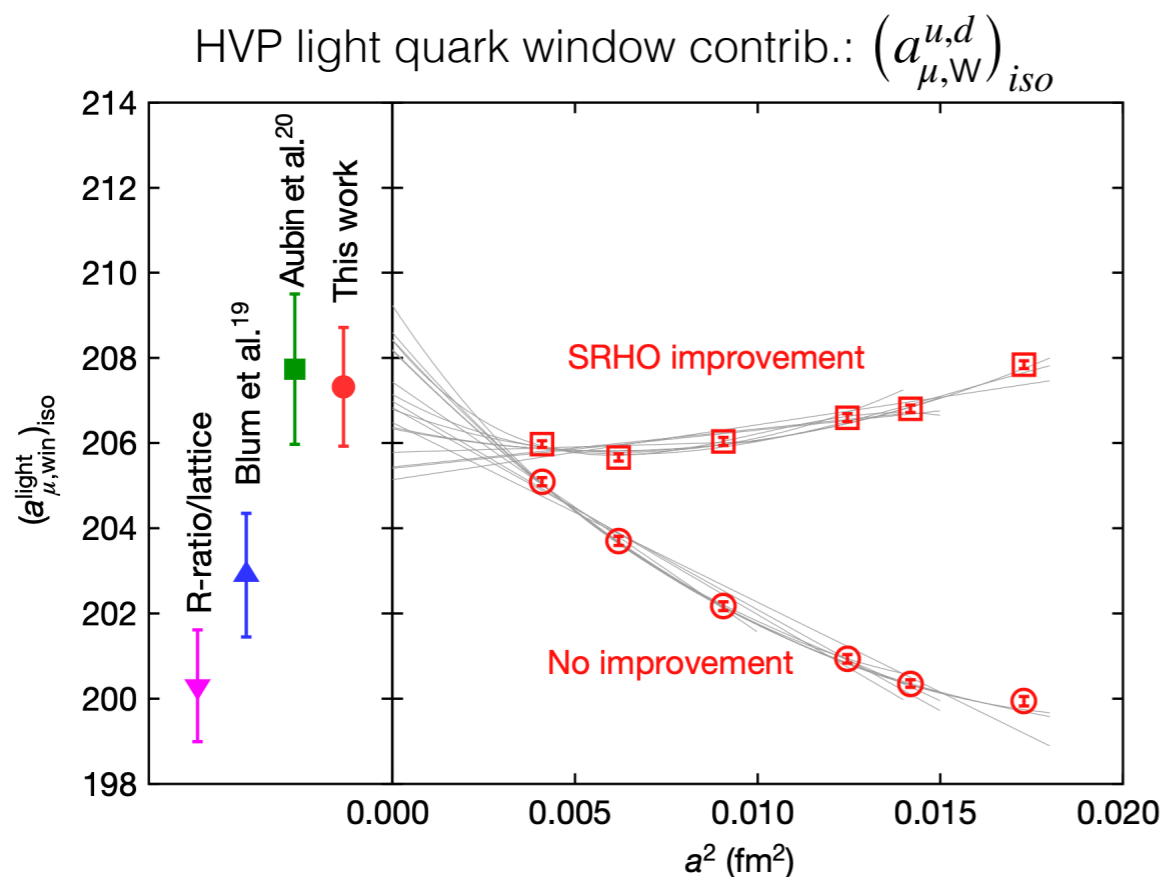

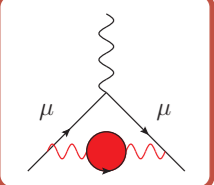

Lattice computation of $a_\mu^{\text{HVP,LO}}$

◆ Quark-connected contribution:

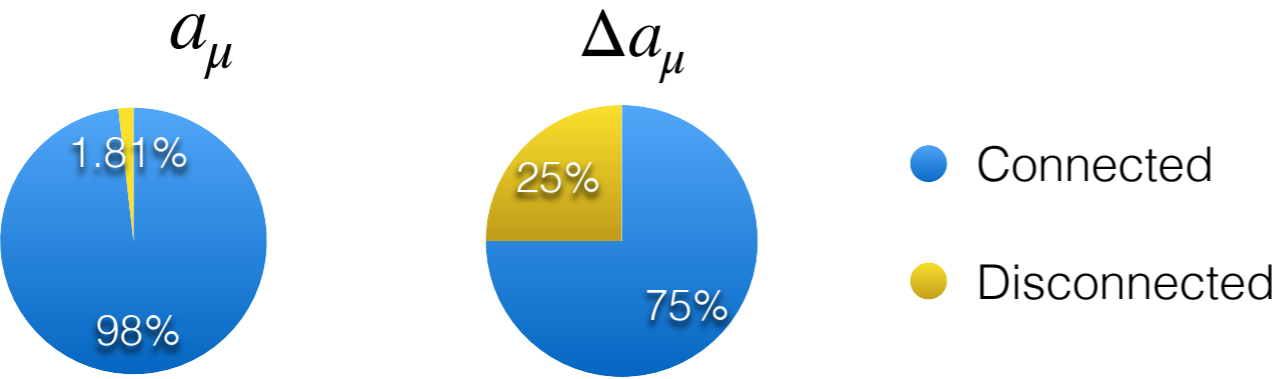
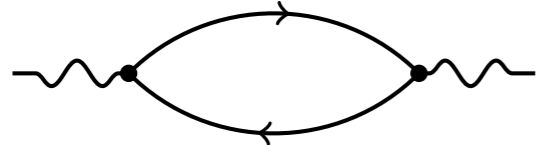

$$a_\mu^{\text{W2}} \equiv a_\mu^{\text{win}(1.5, 1.9, 0.15)}$$

◆ Quark-disconnected contribution:

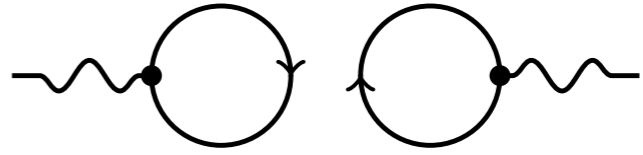

[RBC/UKQCD: PRL116(2016)232002, ...
 BMW: Borsanyi et al. Nature593 (2021)7857, arxiv:2002.12347]

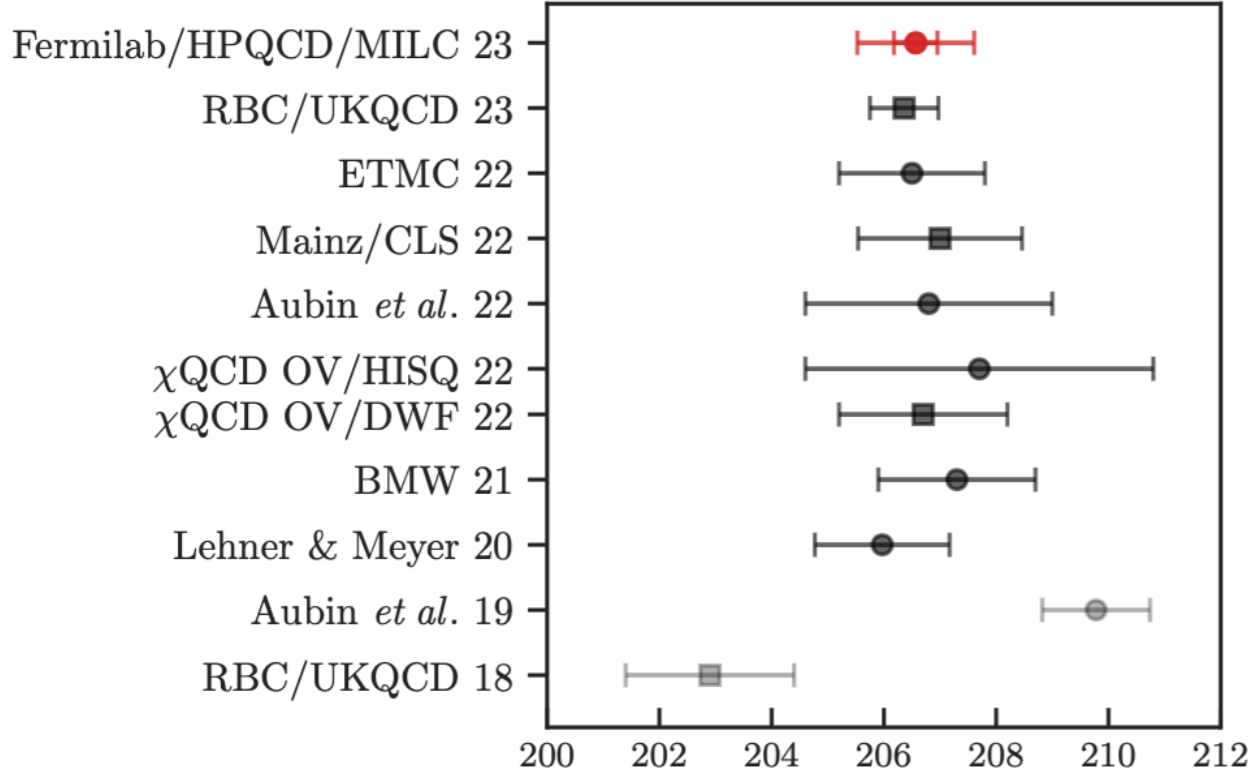

[Fermilab/HPQCD/MILC 2301.08274 [hep-lat]]

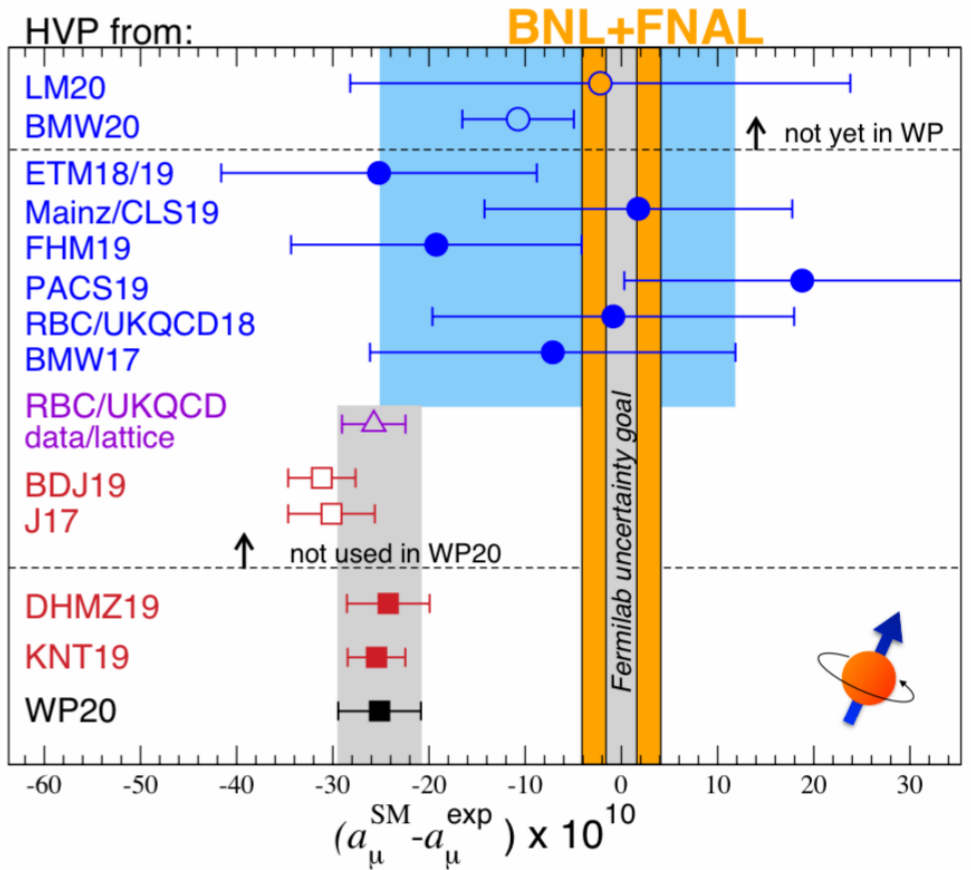

[Snowmass22 2203.15810 [hep-ph]]

Prospects for the HVP independent measurement

[MUonE Collaboration <https://web.infn.it/MUonE/>]

[For more details, see LOI]

<https://cds.cern.ch/record/2677471>

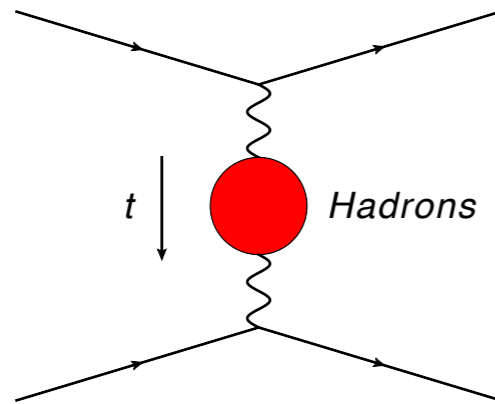

- ➔ In space-like (Euclidean) momenta region
- ➔ Obtain $a_{\mu}^{had,LO}$ by utilising the running of α_{QED} in a space-like process

$$a_{\mu}^{had,LO} = \frac{\alpha}{\pi} \int_0^1 dx (1-x) \Delta\alpha_{had}[Q^2(x)]$$

[Lautrup, de Rafael '69, de Rafael, PLB(1994), Blum PRL(2002)]

- ➔ Proposal to measure precisely the Q^2 - dependent fine-structure constant:

$$\alpha(Q^2) = \frac{\alpha(0)}{1 - \Delta\alpha(Q^2)}$$

[Phys.Lett. B746 (2015) 325-329 by Carloni, Passera, Trentadue, Venanzoni] @e+e- detector

[Eur.Phys.J. C77 (2017) no.3, 139 by Abbiendi et al.] @CERN



FNAL E989: Muon g-2

J-PARC E34: Muon g-2/EDM

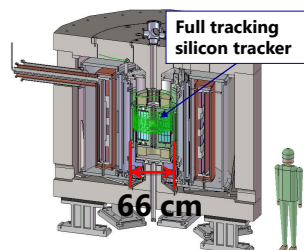

■	Physics
■	Long Shutdown (LS)
■	Beam commissioning
■	Technical stop

LHC schedule

